

 **KENWOOD**

2m ALL MODE TRANSCEIVER

Model TR-9130



INSTRUCTION MANUAL

INTRODUCTION

You are the owner of our latest product, the new TR-9130 transceiver. Please read this instruction manual carefully before placing your transceiver in service. The unit has been carefully engineered and manufactured to rigid quality standards, and should give you satisfactory and dependable operation for many years.

AFTER UNPACKING

- Shipping container:
Save the boxes and packing in the event your unit needs to be transported for remote operation, maintenance, or service.
- The following explicit definitions apply in this manual:
Note: If disregarded, inconvenience only, no risk of equipment damage or personal injury.
Caution: Equipment damage may occur, but not personal injury.

CONTENTS

FEATURES	3
BEFORE USE	3
SPECIFICATIONS	4
SECTION 1. PREPARATION FOR USE	5
1.1 Accessories	5
1.2 Installation	5
SECTION 2. CONTROLS AND TERMINALS	8
2.1 Front panel	8
2.2 Rear panel	10
SECTION 3. OPERATION	11
3.1 Mode switch	11
3.2 Digital VFO	11
3.3 DS switch	12
3.4 Memory switch	12
3.5 Scan operation	13
3.6 TX Offset switch	13
3.7 Squelch	13
3.8 RIT and RIT switch	13
3.9 NB (Noise blanker)	14
3.10 RF GAIN and S meter	14
3.11 HI/LOW switch	14
3.12 Transmitter precautions	14
3.13 CW operation	14
3.14 Aux terminal	15
3.15 BATTERY installation	15
3-16 TONE switch	15
SECTION 4. OPTIONAL ACCESSORIES	16
BLOCK DIAGRAMS	17
SCHEMATIC DIAGRAMS	19

FEATURES

1. 2m all band transceiver for FM, SSB (USB, LSB), and CW operation.
2. Rotary click, 100Hz step (1kHz, 5kHz, 12.5kHz and 25kHz steps depending on the mode and the position of the DS switch) digital 2-VFO system specifically designed for mobile operation.
3. Five-digit display indicates frequency of all operating modes.
4. TX OFFSET switch shifts frequencies $\pm 600\text{kHz}$ for standard repeater operation.
5. Six memory channels. Two different frequencies (transmit and receive) are stored in CH6, permitting "odd-split" repeater operation.
6. A newly designed SSB squelch circuitry is employed to provide comfortable operation as well as in FM mode.
7. Optimum frequency step to suit each mode can be selected by the DS switch.
8. Incorporates auto scan circuit (BUSY signal stops in all FM mode).
9. Automatic selection of RIT, NB, RF GAIN and AGC.
10. The transceiver has a memory scan circuit which scans only the channels stored in the memory.
11. The CW break-in circuitry and the side-tone circuitry available in all modes are incorporated.
12. Hand microphone with frequency UP-DOWN switch.
13. In the SSB/CW mode, the transmit frequency is variable and can be used for Oscar communication.
14. RF POWER HI-LOW switch.
15. Unique escutcheon design allows easy installation for mobile operation.
16. Full variety of accessory terminals (KEY, AUX, BACK UP, STBY, EXT SP).
17. A memory back-up Ni-Cd battery can be installed.

BEFORE USE

KEEP OUT

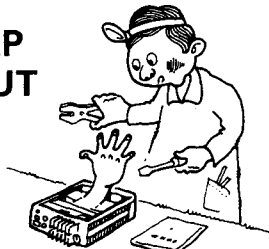

Do not adjust coils, trimmers, or pots!
These are factory adjustments.

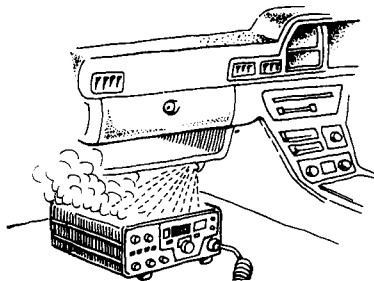

Do not install near heater outlet.

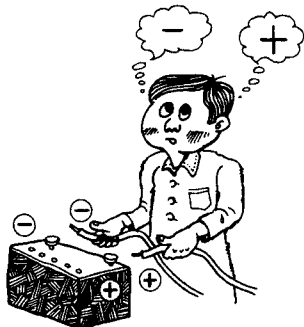

BEFORE connection, check polarity.

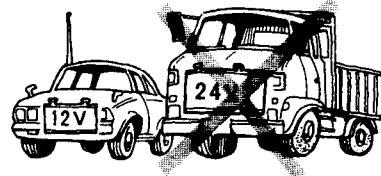

This unit is descened for 12V, negative ground ONLY.

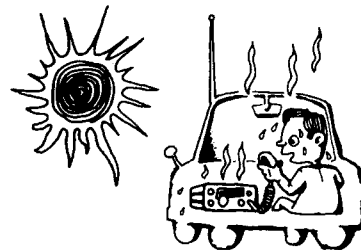

After parking in the sun, and inside temperature is HOT, cool this unit BEFORE transmitting.

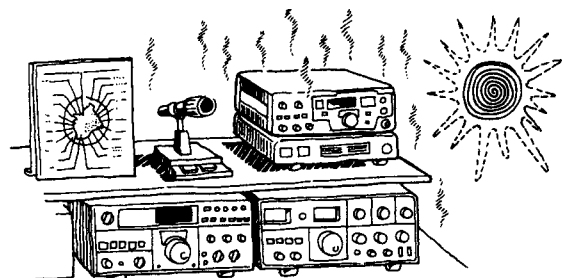

Keep equipment away from heat and out of direct sunlight.

SPECIFICATIONS

[General]

Semiconductors	ICs	12
	FETs	15
	Transistors	105
	Diodes	126
Frequency range	144.000.0 to 145.999.9 MHz	
Frequency synthesizer	Digital control, phase locked VCO	
Mode	SSB (A3j), FM (F3), CW (A1)	
Frequency stability	Within $\pm 500\text{Hz}$ during the first hour after 1 minute of warm up, and within 50Hz any 30 minutes thereafter at 25°C (constant).	
Power requirement	13.8V DC $\pm 15\%$	
Grounding	Negative	
Operating temperature	- 20°C to + 50°C	
Current drain	0.7A in receive mode with no input signal 6.5A in HI transmit mode (Approx.) 3.5A in LOW transmit mode (Approx.) Less than 3.0mA for memory back up	
Dimensions	170mm (6-11/16") wide 68mm (2-11/16") high 241mm (9-1/2") deep (projections not included)	
Weight	2.4kg (5.5lbs)	

[Transmitter Section]

RF output power (at 13.8V DC, 50Ω load)	HI (SSB, FM, CW)	25W min.
	Low (FM, CW)	5W approx.
Modulation	FM	Variable reactance direct shift
	SSB	Balanced modulation
Tone frequency	1750Hz	
Frequency tolerance	SSB, CW	Less than $\pm 10 \times 10^{-6}$
	FM	Less than $\pm 20 \times 10^{-6}$
Spurious radiation	HI	Less than - 60dB
	LOW	Less than - 53dB
Carrier suppression	Better than 40dB	
Unwanted side band suppression	Better than 40dB	
Maximum frequency deviation (FM)	$\pm 5\text{kHz}$	
Microphone	Dynamic microphone with PTT switch, 500Ω	

[Receiver Section]

Circuitry	FM	Double conversion superheterodyne
	SSB, CW	Single conversion superheterodyne
Intermediate frequency	1st IF	10.695MHz
	2nd IF (FM)	455kHz
Receiver sensitivity	FM	Better than 0.5μV for 30dB S/N Better than 0.2μV for 12dB SINAD
	SSB, CW	0.2μV for 10dB S/N
Receiver selectivity	FM	More than 14kHz (- 6dB) Less than 30kHz (- 60dB)
	SSB, CW	More than 2.2kHz (- 6dB) Less than 4.8kHz (- 60dB)
Spurious interference	Better than 70dB	
Squelch sensitivity	0.16μV (Threshold)	
Auto scan stop level	Less than 0.2μV (Threshold)	
Audio output	More than 2.0 watts across 8ohms load (10% dist.)	

Note: Circuit and ratings are subject to change without notice due to developments in technology.

SECTION 1. PREPARATION FOR USE

1.1 Accessories

Carefully unpack your TR-9130 and check that it is supplied with the following accessories:

- (1) Dynamic microphone (with U/D switch)
(T90-0313-05) 1 piece
- (2) Mounting bracket..... 1 ass'y
Mounting parts:
Hex wrench (W01-0401-04)..... 1 piece
Nuts (5mm diameter) (N14-0510-04) 4 pieces
Hex-socket screw (N09-0008-04) 4 pieces
Flat washers (6mm diameter)
(N15-1060-46) 4 pieces
Spring washer (6mm diameter)
(N16-0060-46) 4 pieces
- (3) Leg (for fixed station) (J02-0416-04) 1 pieces
- (4) DC power cord (with 2P plug and fuse)
(E30-1709-05) 1 piece
- (5) Spare fuse (7A) (F05-0725-05) 1 piece
- (6) Miniature plug (for stand-by) (E12-0401-04) 1 piece
- (7) Miniature plug (for external speaker or key)
(E12-0001-05) 1 piece
- (8) 4P plug (for AUX terminal) 1 piece

- (9) Battery holder ass'y..... 1 ass'y
Battery snap (E91-0302-05)..... 1 piece
Battery holder (J21-2754-04)..... 1 piece
Round screw (N33-3006-45) 3 pieces
Battery cushion (G13-0656-04)..... 3 pieces

1.2 Installation

1.2.1 Interconnection

Connect the antenna and power supply as shown in Fig. 1-1 for fixed station or mobile operation.

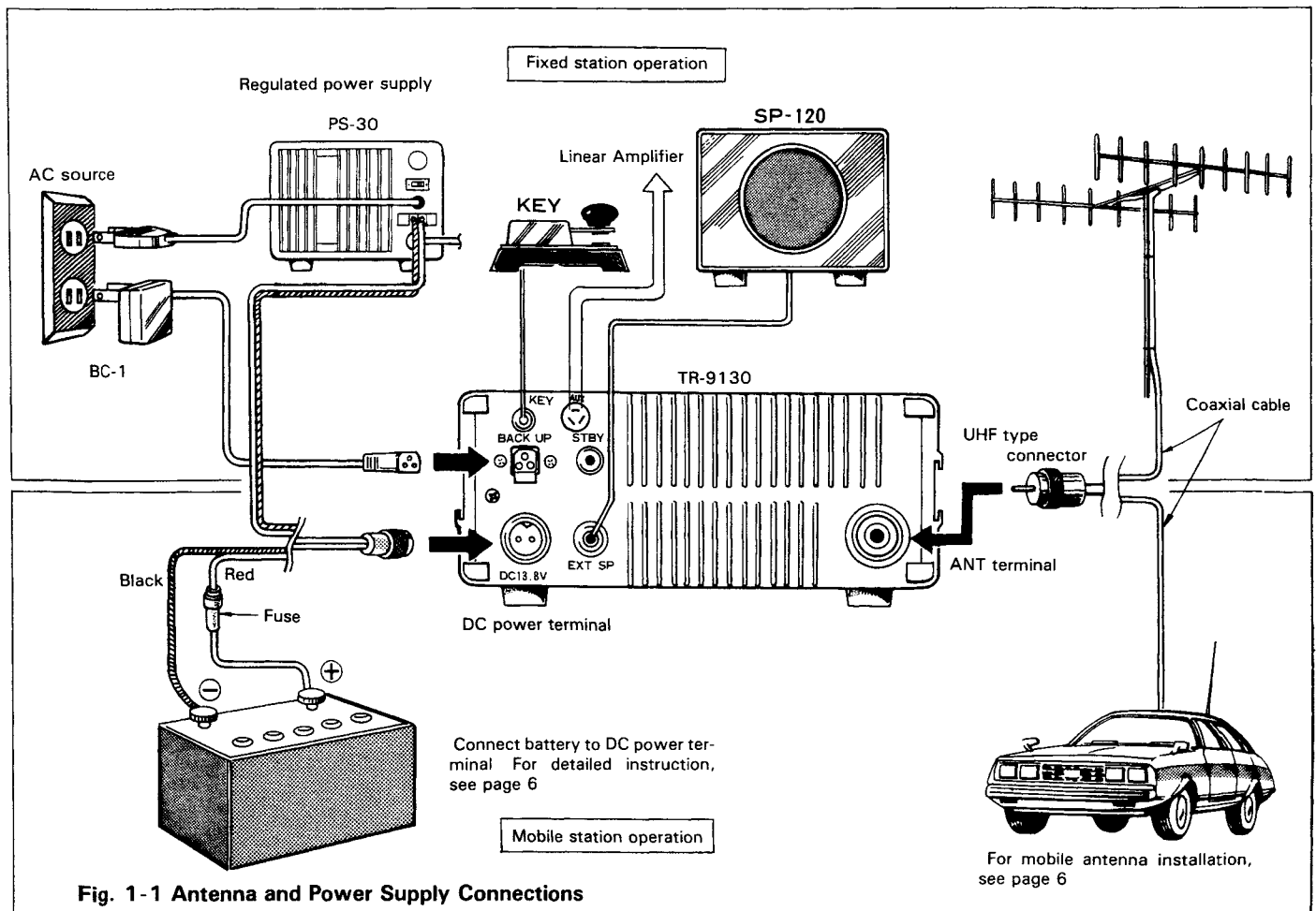

Fig. 1-1 Antenna and Power Supply Connections

For mobile antenna installation, see page 6

1.2.2. MOBILE installation, [general]

• Installation location

Using the supplied mounting bracket, install the transceiver under the dashboard or on the side of console in your car.

Refer to Fig. 1-2A and Fig. 1-2B.

If your car is equipped with an electronic fuel injector, the transceiver should be as far from the control, equipment as possible.

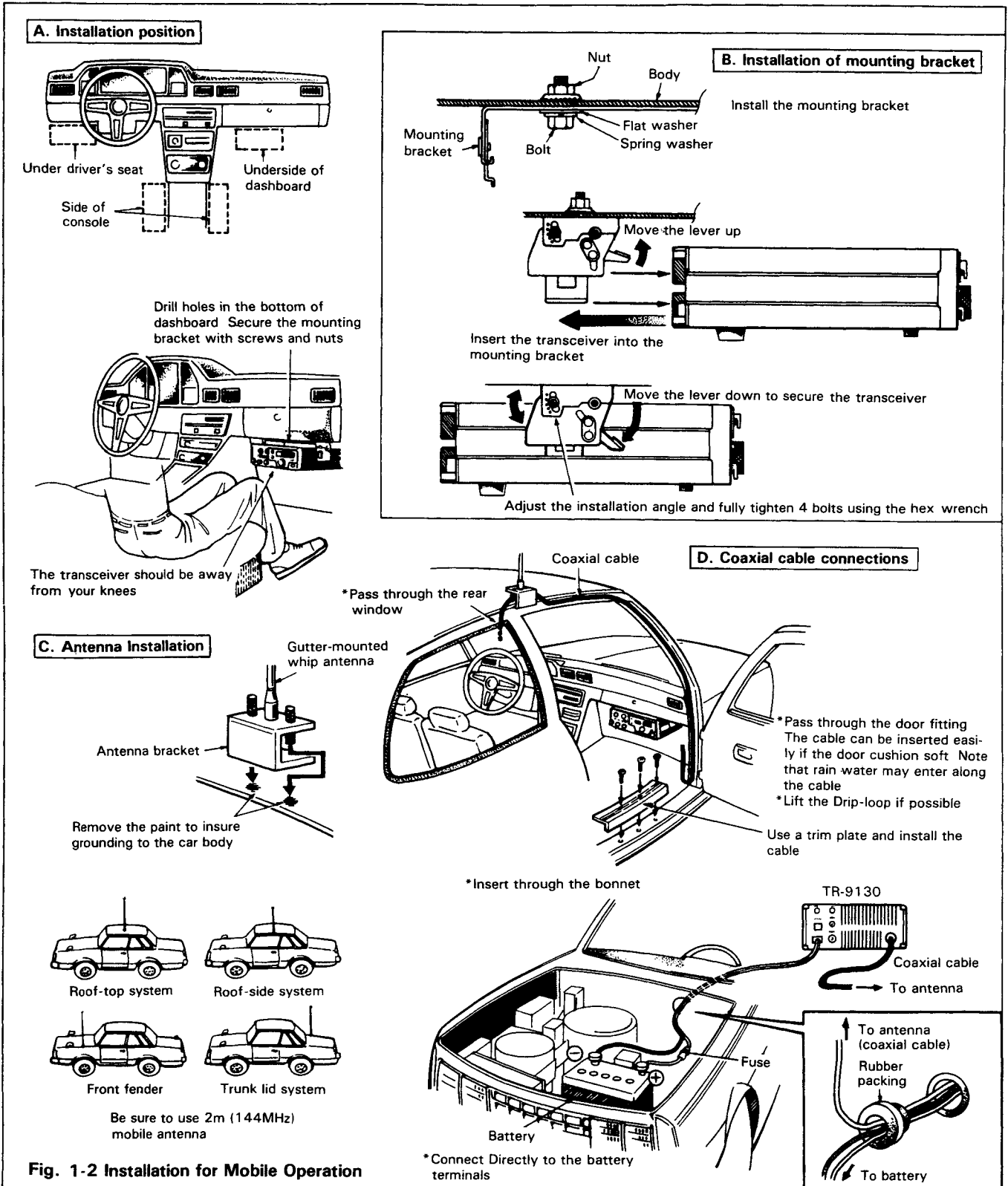

Fig. 1-2 Installation for Mobile Operation

• Antenna installation

Various types of antennas for 2 meters mobile operation are available. (See Fig. 1-2C)

NOTE:

For gutter-mount installation, the antenna bracket must be grounded to the car body as shown in Fig. 1-2C. Affix the antenna securely, referring to the antenna instruction.

• Power supply

Connect the supplied power cord with fuse directly to the battery terminals. Connecting to the cigarette lighter socket can cause a poor connection, and excessive voltage drop.

• Back up power for micro-computer

With power supplied from battery, the micro-computer keeps operating even when the power switch is OFF. In this case, current drain is very low, approximately 2.5mA. The car can be parked overnight with little battery power consumed.

However, when the car is to be parked for a long period of time (more than 1 month), it is advisable to disconnect the power plug, in this case, the back up function is disabled. Meanwhile an user supplied 9 V type Ni-Cd battery can be installed for backup with the supplied battery holder. (Refer to 3.4 and 3.5)

• Ignition noise

The transceiver is designed to suppress ignition noise;

however, if excessive noise is present, it may be necessary to use suppressor spark plugs (with resistors).

1.2.3. FIXED STATION installation, [general]

• Power supply (Fig. 1-3)

The PS-30 optional power supply is recommended.

• Antenna (Fig. 1-3)

Various types of fixed station antennas are commercially available. Select your desired antenna according to your installation space and application (DX, local QSO, etc.). Note that the SWR of your antenna should be less than 1.5. A high SWR will cause the TR-9130 protective circuit to operate, reducing the transmit output power.

The TR-9130 is factory adjusted to deliver the rated RF output (25W) at about 145MHz, where the RF meter indicates "8" on the 10-division (lower) uniform scale. The RF meter will indicate about this point when the antenna SWR is less than 1.5.

• Micro-computer back up (retention of memory function)

Unless the power source is disconnected, the micro-computer keeps its back up function even if the power switch is turned OFF. If you desire back-up with the power source disconnected, plug the battery charger BC-1 into the back-up power socket on the rear of the TR-9130.

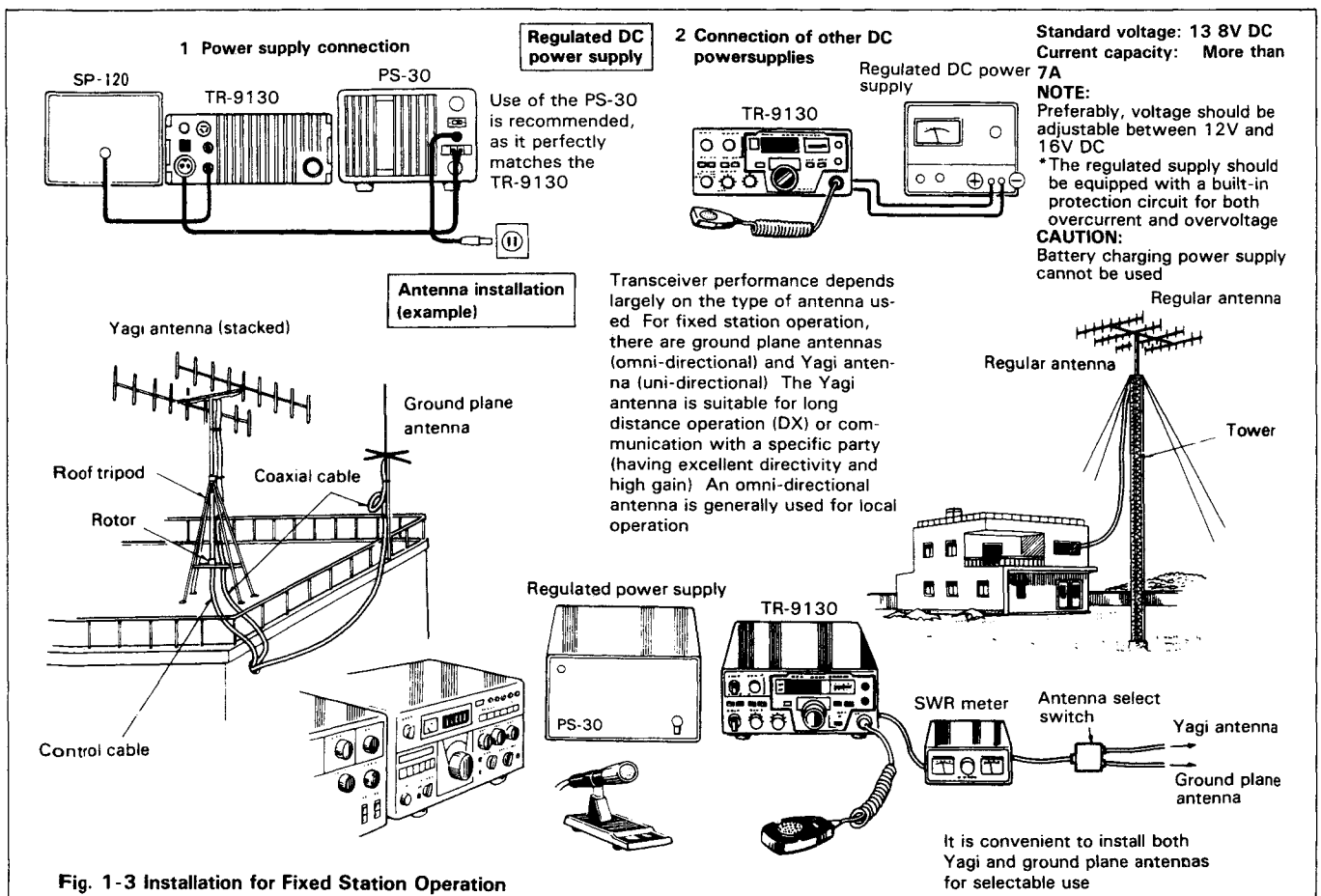
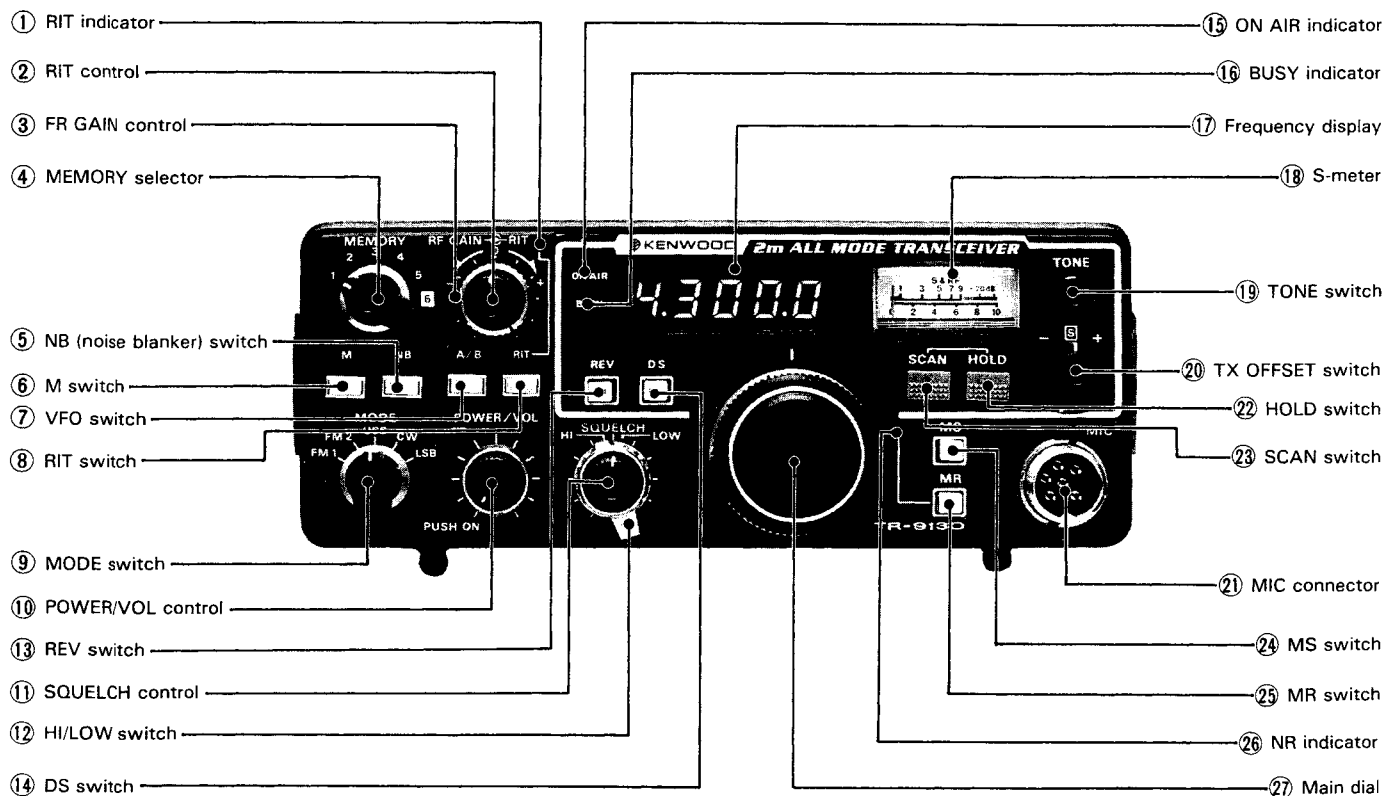

Fig. 1-3 Installation for Fixed Station Operation

SECTION 2. CONTROLS AND TERMINALS



① RIT indicator

This lamp lights when the RIT circuit is operated.

② RIT control

In SSB or CW mode, the receive frequency can be fine adjusted without changing the transmit frequency. The center position "0" is RIT-OFF.

③ RF GAIN control

This control adjust the gain of the receiver. Maximum gain is obtained at the full clockwise position. Normally, this control should be left fully clockwise.

④ MEMORY selector

This switch is used to select memory channels "1" through "6". The operating frequency can be stored in or called back from the channel selected by this switch. In channel "6", two different frequencies (transmit and receive) can be stored for repeater operation with split frequencies other than $\pm 600\text{kHz}$.

⑤ NB (noise blanker) switch

This switch is used to eliminate pulsating noise such as ignition noise from a car. Press () the switch ON in SSB or CW mode.

⑥ M switch

This is used to input desired frequencies to each channel for memory. By pressing () the switch, a memory check signal is heard and the frequency indicated on the display is stored in the selected channel.

⑦ VFO switch

This is used to select VFO-A VFO-B. The VFO-A and VFO-B are actually the same, except reset frequency is different.

Reset frequency: VFO-A ... 145.0000MHz

VFO-B ... 144.0000MHz

⑧ RIT switch

RIT ON-OFF switch. Press () the switch to ON. The RIT lamp will light to indicate the RIT circuit is in use

⑨ **MODE switch**

This switch is used to select the mode of operation, FM1, FM2, USB, CW, or LSB. The frequency step and the number of digits displayed are controlled by the DS switch.

⑩ **POWER/VOL control**

Push button type, power ON-OFF switch and volume control are combined. Clockwise rotation will increase the volume.

In the power OFF position, about 2.5mA current is drawn to back-up the micro-computer, and 6mA of leakage current to final module provided the power cable is connected to a constant power source.

To completely disable the transceiver, disconnect the power cable.

⑪ **SQUELCH control**

The squelch control is used to eliminate noise during no-signal time. Normally, this control is adjusted clockwise until the noise disappears and the BUSY lamp goes off (threshold level).

⑫ **HI/LOW switch**

This switch is used to set transmit output power to either 25W (high) or 5W (low) in FM or CW mode. In SSB mode, the power is high regardless of switch position.

⑬ **REV switch**

In receive, this switch is used to reverse the repeater shift (± 600 kHz) and other transmit/receive frequencies. It is a momentary non-lock type switch and returns to the normal out position when released.

⑭ **DS switch**

By using this switch, the digital steps called channel separation are changed. Press the switch to ON. In the FM1 mode, the frequency step is 25 kHz regardless of the DS switch position. In the FM2 mode the frequency step is 12.5 kHz when this switch is OFF and 1 kHz when it is ON. In the SSB or CW mode, the "kHz" and "100 Hz" frequency data being displayed are set to "0.0", then the frequency is shifted rapidly at 5 kHz intervals.

⑮ **ON AIR indicator**

A light emitting diode (L.E.D.) will light in the transmit mode.

⑯ **BUSY indicator**

This indicator will light when the squelch is open in all receive mode.

⑰ **Frequency display**

LEDs display the operating frequency in 5 digits (MHz-100Hz), or 4 digits (MHz-1kHz) according to the frequency step.

⑱ **S-meter**

This meter indicates receive input signal strength (S) or transmit output (RF). The upper scale is used for reading "S" in SSB or CW mode. The lower 10-division uniform scale is used in FM mode. (B31-0625-05)

⑲ **TONE switch**

When this switch is pressed, the repeater control tone signal (1,750Hz) circuit is activated and the unit is set in the transmit mode.

⑳ **TX OFFSET switch**

Shifts the transmit frequency for repeater operation.

⊕: Switches the transmit frequency up 600kHz from the receive operation.

S: Simplex (receive and transmit frequencies are the same.)

⊖: Switches the transmit frequency down 600kHz from the receive frequency.

㉑ **MIC connector (6-pin)**

For connection of the supplied microphone.

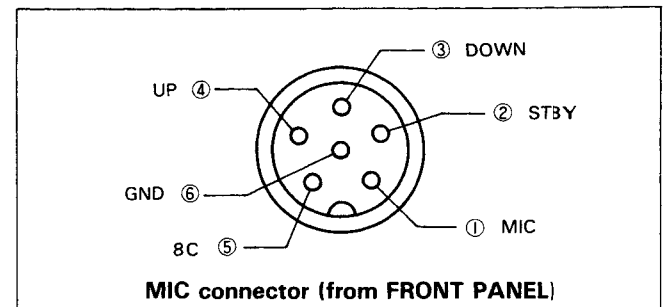

㉒ **HOLD switch**

This switch is used to release scan operation.

㉓ **SCAN switch**

By using this switch, the scan operation is started according to the mode step (VFO should be used). In MS (memory scan) operation, this acts as a restart switch after pressing the HOLD switch. The SQUELCH control should be set the threshold level for SCAN operation.

㉔ **MS (memory scan) switch**

With this switch depressed the TR-9130 scans only memory channels in which frequencies have been preset and the dot indicating MHz digit in the frequency display cycles on and off. For returning to the usual operation, push this switch again.

㉕ **MR switch**

This is used to output memory frequencies from each channel. By pressing () the switch, a memory frequency is displayed in 5 digits, regardless of the operating mode.

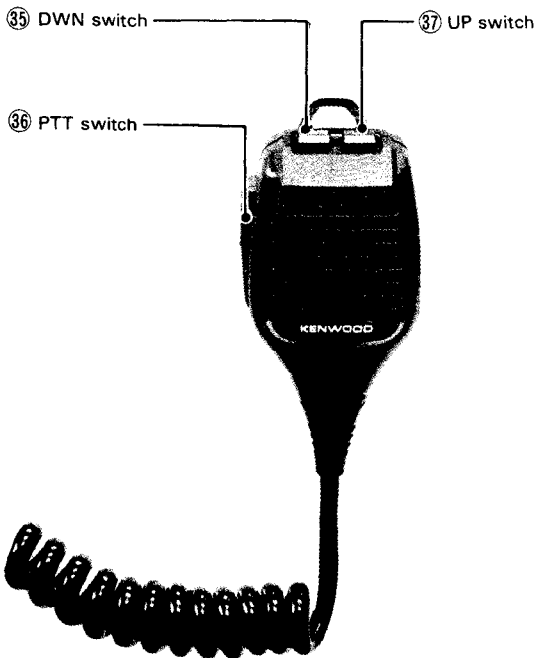
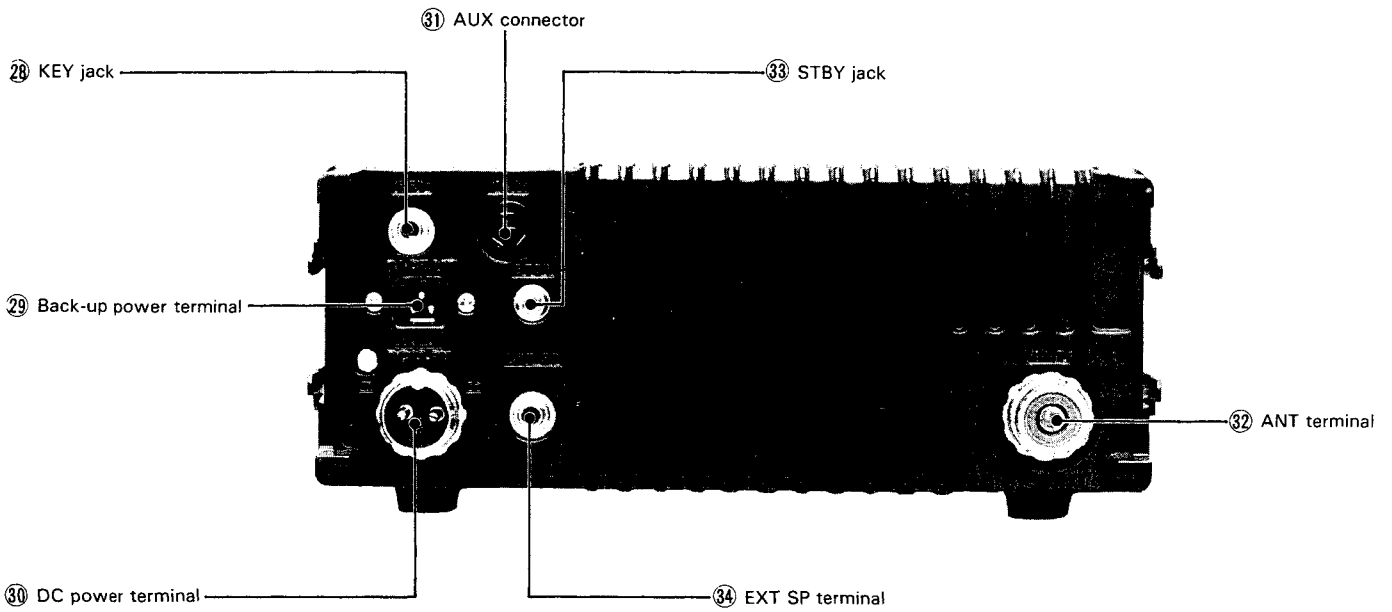

28 KEY jack
For connection of a key using the supplied plug. Use shielded Line and observe polarity.

29 Back up power terminal
Used for fixed station operation. The micro-computer retains the VFO frequency memory function even when the power supply is turned OFF, when back-up power is supplied.

30 DC power terminal
DC power input terminal. Connect the supplied power cord with plug. Input voltage is 13.8V DC. Observe plus (+) and minus (-) polarity is correct.

31 AUX connector
For connection of a linear amplifier. Use the supplied plug.

32 ANT terminal
Antenna terminal. Connect an antenna of 50 ohms impedance.

33 STBY jack
For connection of an external standby switch (transmit/receive select switch). Use the supplied plug

34 EXT SP terminal
External speaker terminal. Connect a speaker of 8 ohm impedance using the supplied plug.

26 MR indicator
This indicator will light when the MR switch is depressed.

27 Main dial
A click type rotary digital VFO control selects transmit and receive frequencies. Frequency is changed at each click according to the mode step. This digital VFO control is an endless type, changing frequency continuously from the upper to lower end of the band.

35 **DWN switch**

This switch is used to step down the digital VFO frequency. When operating the switch, tone will sound.

36 **PTT switch**

Press-to-talk switch used for transmission. This will also release scan operation.

37 **UP switch**

This switch is used to step up the digital VFO frequency. When operated, a tone will sound. When the DWN or UP switch is continuously depressed, the frequency shifts rapidly. Pressing both the UP and DOWN switches simultaneously results in stopping the VFO operation.

SECTION 3. OPERATION

3.1 MODE SWITCH

The five-position MODE switch functions as follows:

FM1: FM frequency is selected in 25 kHz steps by using the VFO. When the DS switch is ON, regardless of the DS switch position.

FM2: In this mode, FM frequencies are selected in 12.5 kHz step. When the DS switch is ON, frequencies are shifted in 1 kHz step.

USB: Normal mode for 2m SSB. Frequencies are tuned in 100 Hz step. When the DS switch is ON, frequencies are shifted in 5 kHz step.

CW: CW mode operates A1. KEY jack and STBY jack are provided on the rear of the TR-9130. Connect a key for CW operation. The filter for SSB mode is also used for CW mode. The AGC time constant is automatically "fast".

LSB: This mode is not used for 2m SSB, but is used for special operation such as Oscar satellite communication.

3.2 DIGITAL VFO

The TR-9130 incorporates a digital 100 Hz step 2-VFO system (click type rotary) controlled by micro-computer.

NOTE:

1 Since all the functions are controlled by a microcomputer, the transceiver must be operated in the priority order given in the following Table.

For example, the digital VFO will not operate when the

main dial is turned during MR operation. Also, it will not operate unless scan operation is released by the HOLD switch or the microphone PTT switch, even if scan is stopped for a brief period of time in receive mode.

2. The digital VFO operates according to the MODE switch position as follows:

FM mode: Only RECEIVE frequency variable.

SSB/CW mode: Both RECEIVE and TRANSMIT frequencies variable.

Consequently, in SSB/CW mode, the priority functions (MS, MR, SCAN, etc) can be accepted in transmission. In FM mode, those functions can not be accepted in transmission.

3 **The digital VFO is factory adjusted under rigid quality standards to insure excellent frequency linearity and stability.**

• **Tuning**

1. Operating frequencies are basically tuned by the main dial. Turning the dial to the right will shift the frequency UP. If fine adjustment is desired in SSB or CW mode, the RIT circuit may be operated.

2. The digital VFO can be step tuned by the microphone UP/DWN switches. A tone will sound at each switch press. The VFO frequency shifts rapidly when the switch is continuously depressed. The tone will then become continuous.

3. The digital VFO covers from 144.0000 to 145.9999MHz in continuous mode. The VFO can be tuned either left or right.

4. The transceiver incorporates two VFOs, VFO-A and VFO-B. VFO Selection is by the VFO switch. VFO-A and VFO-B are the same in function, except that each has its own reset frequency.

5. In SSB mode, the VFO frequency is tuned in 100Hz steps. In 2m SSB operation, the USB mode is generally used. If the VFO frequency is shifted UP in 100Hz steps, the demodulated audio signal changes from high to low pitch. For optimum SSB operation, tune the VFO so the demodulated signal is clear and natural. Frequency can be fine tuned by the RIT, ± 800 Hz from the frequency displayed.

Sequence	Function	Switch and Controls
1	REV	REV ON
2	Memory scan	MS ON
3	Memory recall	MR ON
4	UP/DOWN operation	UP/DOWN ON
5	Scan operation	SCAN, HOLD
6	Digital VFO	Main dial
7	Memory write	M ON

Table 3-1

• Frequency display

1. The digital frequency display indicates carrier frequency in SSB and FM modes. The frequency displayed is the operating frequency.
2. In CW mode, the frequency display indicates the receiver carrier frequency. Transmit frequency is 800Hz higher than displayed. (Operating frequency is 800Hz higher than displayed when receiving an 800Hz beat note.) (See Fig. 3-1).

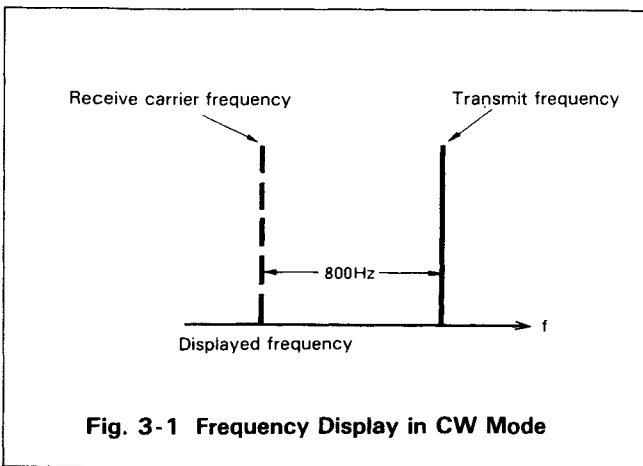

Fig. 3-1 Frequency Display in CW Mode

3.3 DS SWITCH

Frequency steps and display digits change as shown in Table 3-2 by depressing the DS switch

Function / Mode	DS : OFF		DS : ON	
	Step	No of display digits	Step	No of display digits
FM1	25 kHz	4 digits	25 kHz	4 digits
FM2	12.5 kHz	5 digits	1 kHz	4 digits
USB CW LSB	100 Hz	5 digits	5 kHz	5 digits

Table 3-2

3.4 MEMORY SWITCH

Using this switch, commonly used frequencies (repeaters, etc.) can be stored in the memory. Frequencies set by the VFO are stored in channels 1 through 6 by using the M switch. Stored frequencies can be called-up by placing the MR switch ON.

Two different frequencies (transmit and receive) can be stored in channel 6 in FM mode, so the transceiver will operate on any repeater split. The receiver frequency is stored in memory just as for channels 1-5. To store the transmit frequency in memory, set the transmit frequency in receive mode and then press the M switch. (See Fig 3-3) In SSB and CW modes, channel "6" is used as a normal simplex memory.

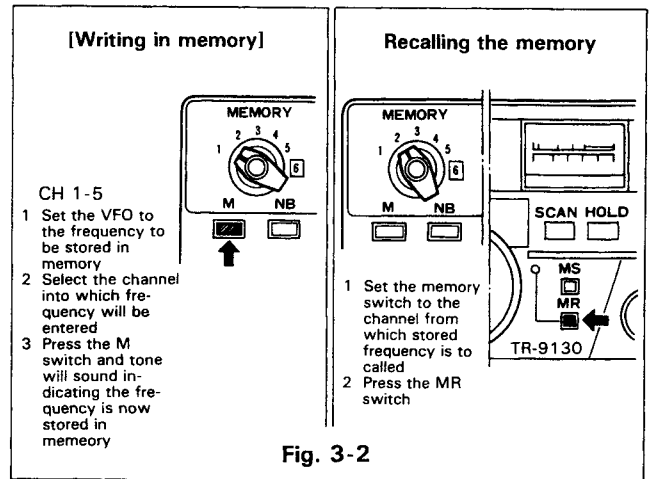

Fig. 3-2

NOTE:

1. When a memory is vacant, the memory frequency is 144.0000MHz.
2. The memory frequency called-up by the MR switch is displayed in 5 digits, regardless of mode.

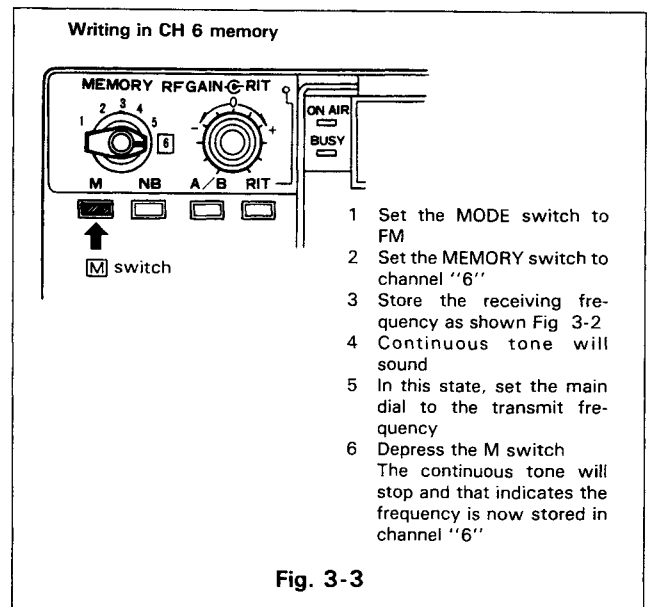

Fig. 3-3

3. To clear a frequency stored in memory, simply store a new frequency in that memory.
4. If you desire to retain the memories, back-up power should be supplied to the micro-computer.
 - (1) A power cord should be connected directly to the battery terminal.
 - (2) A back-up supply (BC-1) should be used. In either case, back-up current of about 2.5 mA is required.

Meanwhile a 9 V type Ni-Cd rechargeable battery (user supply) can be installed for memory backup. (Refer to 3-15)

If the Ni-Cd battery is fully charged, the memories can be backed up for about one day with all power supplies cut.

off.

And when DC power is supplied to the transceiver, the battery is charged all the time regardless of the POWER switch position.

In this case, current drain is about 5 mA (back up plus charge current).

3.5 SCAN OPERATION

TR-9130 scan operation is classified into auto scan (signal stops at a certain point and scan restarts when signal is absent) and memory scan.

• Auto scan

In auto scan operation, a 1 MHz bandwidth is scanned.

1. Set the squelch control to the threshold point (noise disappears at no-signal time and BUSY indicator goes off).
2. Next, press the SCAN switch to start scan operation. At the DS switch OFF, the scan step becomes 1 kHz in SSB and CW modes. In the other case, scan is carried out in accordance with the MODE and DS switch position.
3. When a signal is present, scanning stops. When the signal drops scan restarts automatically.
4. Under SCAN or busy stop in SCAN, the dot indicating MHz digit in the frequency display cycles on and off. This dot cycling enables you to distinguish between the SCAN operation and the usual VFO operation.
5. If you desire to hold the frequency at which the scan stops, press the HOLD switch or press the microphone PTT switch ON momentarily in FM mode. In SSB or CW mode press the HOLD switch.
6. Scan speed is about 200 mS for each channel. When the scan switch is continuously depressed, scan speed becomes 8 times.

• Memory Scan

This transceiver has 6 memory channels. The MEMORY SCAN is used to scan only the channels stored in the memory.

1. Turn the MS switch to ON.
2. The operating frequency is indicated on all the digits.
3. Auto scan operation is also possible.
4. When the HOLD switch is depressed or the MIC PTT is set to on momentarily, the frequency stops while the MHz dot flickers.
5. To restart the scan, depress the SCAN switch.
6. To release the memory scan, depress the MS switch once again.
7. The 144.0 MHz signal preset is not a memory frequency

• Scan Operation Precautions

1. During scan operation, including temporary scan, stop, the frequency can not be changed by the VFO or the

microphone UP/DOWN switches. To change frequency, it is first necessary to release the scan by pressing the HOLD switch or MIC PTT switch.

2. If the MR switch is pressed during scan operation, the memory scan will not stop because of its priority. To recall the memory frequency depress the MS switch firstly and then push the MR switch and select the memory channel by using the MEMORY switch.

3.6 TX OFFSET SWITCH

The TX OFFSET switch, used for selecting simplex or repeater operation, has three positions.

If the transmitter frequency is shifted beyond the high or low frequency limits, the transceiver will operate in simplex mode, and a warning tone will sound during transmit.

⊕: The transmitter frequency is 600 kHz higher than the receiver frequency.

S: The TR-9130 operates in the usual simplex mode. That is, receive and transmit frequencies are the same. This frequency is indicated on the digital frequency display.

⊖: The transmitter frequency is 600 kHz lower than the receiver frequency.

NOTE:

OFFSET is available for FM modes.

3.7 SQUELCH

To eliminate the noise at no-signal condition turn the squelch slowly clockwise until the noise disappears and the BUSY lamp goes off (threshold point).

Adjust the VFO to an empty frequency. The BUSY lamp will light and the speaker will operate when a signal is received. The squelch control is also used for auto scan operation control.

If the signal is weak or fades during mobile operation, readjust the squelch for the clearest reception.

3.8 RIT AND RIT SWITCH

“RIT” is an abbreviation for “receiver incremental tuning”. The RIT feature enables you to shift receive frequency approximately ± 800 Hz. By adjusting the RIT control in the “+” direction, the receive frequency will be higher than the transmit frequency (and vice versa).

When the RIT control is set to the center “0” position, the frequency is the same as that at RIT OFF, and the frequency indicated on the digital display remains unchanged.

If the receive frequency is incorrect, it can be adjusted by turning the RIT switch ON (the RIT lamp will light). Since the receive frequency can be varied without changing the transmit frequency, there is a difference between the transmit and receive frequencies. Therefore, the RIT switch should be turned OFF when the QSO is finished.

Note that the RIT circuit is available in SSB or CW mode and does not operate in FM1 or FM2 modes.

3.9 NB (NOISE BLANKER)

The noise blanker is used to reduce ignition type impulse noise generated from a car, and allows reception of weak CW or SSB signals. The noise blanker will not operate in the FM modes.

3.10 RF GAIN AND S METER

The RF GAIN control, which is used to control receiver gain, has a range of more than 60dB in SSB or CW mode. Since the RF GAIN function is interlocked with the AGC, it is used to control strong signals. Receiver gain is maximum at full clockwise position, and is reduced by adjusting the control counterclockwise.

In SSB mode, receiver noise can be reduced by using the RF GAIN control. Adjust as necessary, according to signal conditions. Normally, it should be set for maximum gain.

In FM mode, the RF GAIN has a range of about 20dB. It is not interlocked with the S meter.

- FM mode.....The lower 0-10 division linear scale of the S meter is used. Full scale occurs at 15 μ V.
- SSB/CW modeThe upper scale of the S meter is used. The meter reads S-9 at 5 μ V input and full scale at 1mV.

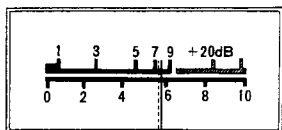

Fig. 3-5 S Meter

3.11 HI/LOW SWITCH

For local FM communication, it is recommended that power be reduced to eliminate interference to other stations and to minimize power consumption. By pressing the HI/LOW switch, transmit power is reduced from 25W to about 5W, while the RF meter reading is about 2 or 3. Low power operates in FM and CW modes. In SSB mode, TR-9130 operates on high power, independent of the HI/LOW switch.

3.12 TRANSMITTER PRECAUTIONS

1. The TR-9130 antenna impedance is 50 ohms. Be sure to connect an antenna of 50 ohm impedance
2. Check the transmit frequency before operating to insure that you do not interfere with other stations.
3. By pressing the microphone PTT switch, The TR-9130 is set in transmit mode; the ON AIR lamp will light and the meter indicate transmit power. Hold the microphone about 5cm from your mouth and speak.

4. In SSB mode, microphone gain has been adjusted for optimum ALC for normal tone of voice. If you speak too loud, the signal will distort, reducing intelligibility.
5. In CW mode:
 - (1) If a key is not connected, CW is transmitted when the PTT switch is pressed.
 - (2) With a key connected, CW signals can be emitted by keying-down as a break-in circuitry is incorporated.

The SIDE TONE circuit will provide a tone about 800 Hz from the speaker.

3.13 CW OPERATION

For CW operation, make connections as shown in Fig. 3-6.

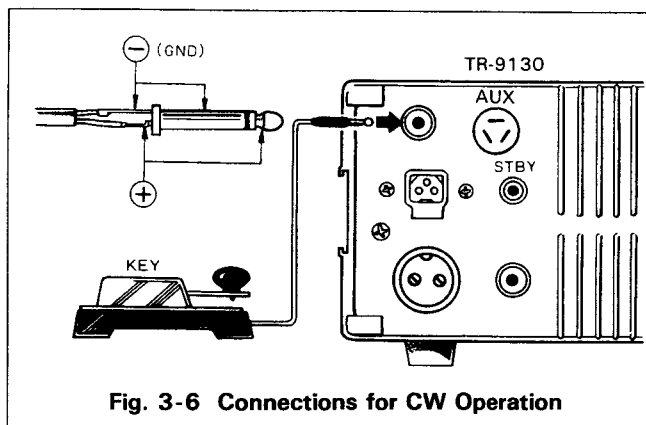

Fig. 3-6 Connections for CW Operation

■ Break-in circuit

The TR-9130 is switched over to transmission mode by key down as a break-in circuit is built-in.

The delay time of semi break-in can be adjusted using the VR-7 (DRIVE unit, X47-1090-00, top chassis).

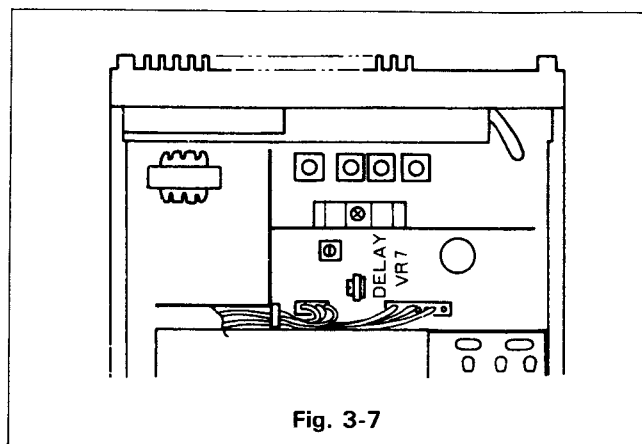

Fig. 3-7

NOTE:

1. CW receive mode is USB. The AGC time constant is automatically switched to "fast" in CW mode, and to "slow" in USB mode.
2. The built-in SIDE TONE circuit allows you to monitor your station's CW signal.

3. When the key is closed, the SIDE TONE circuit provides a tone of about 800Hz. Use this tone as a reference for receiver tuning.
4. In reception, side tone can be monitored at any mode other than CW.

3.14 AUX TERMINAL

The AUX terminal can be used for connection with a linear amplifier. Use the supplied 4P plug.

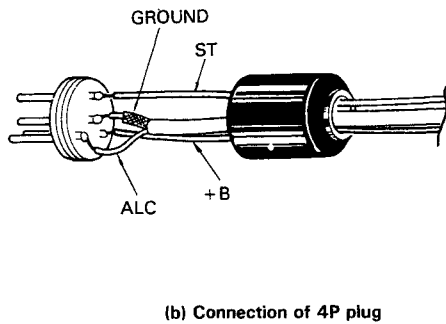
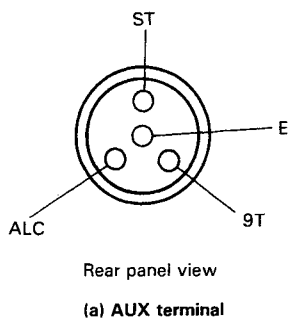
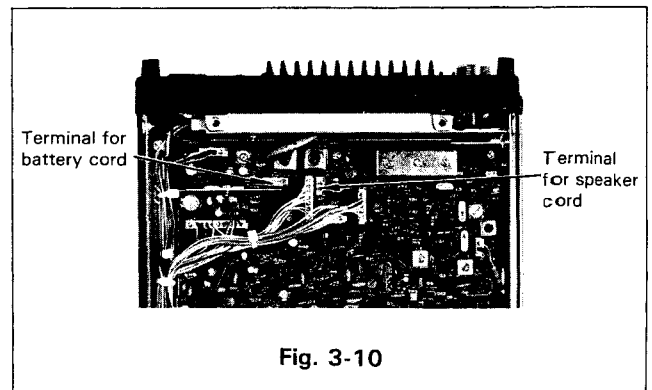
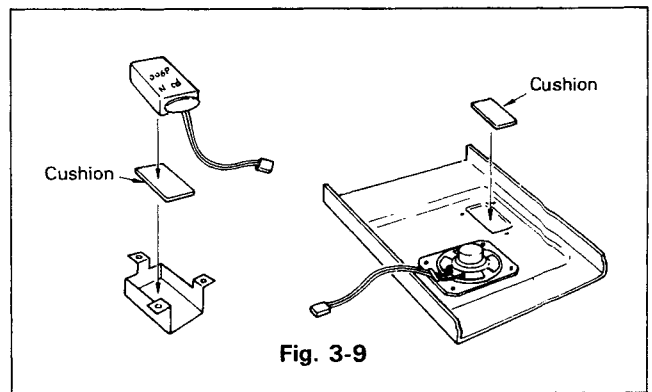

Fig. 3-8 Aux terminal connection

3-15 BATTERY INSTALLATION

1. Prepare a 9 V type Ni-Cd rechargeable battery (user supplied).
2. Remove the bottom cover by 5 screws and pull the speaker lead off.
3. Attach two cushions to the battery holder and the inside of the cover respectively.
(If the battery size is small, apply two cushions to the battery holder),
4. Put the battery into the battery holder and secure the holder to the cover by 3 screws.
5. Insert the speaker and the battery cord connector on the PC board.



SECTION 4. OPTIONAL ACCESSORIES

The following accessories are available for more sophisticated operation of the TR-9130:

■ Fixed Station DC Power Supply PS-30

The PS-30 DC power supply perfectly matches the TR-9130 design. It incorporates a circuit for protecting the transceiver against shorted output and power supply overload.

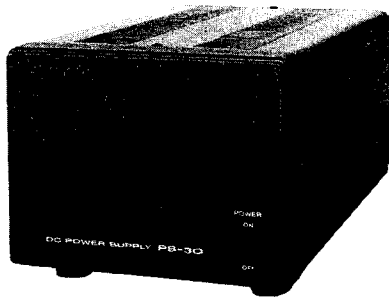

PS-30

■ EXTERNAL SPEAKER SP-120

Designed for fixed station operation. Styling and tone quality match the TR-9130 perfectly.

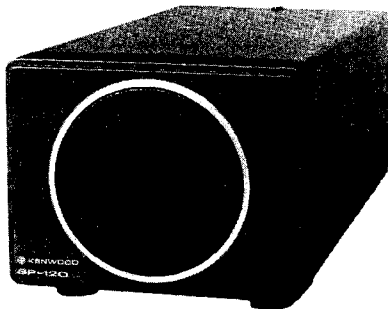

SP-120

■ SP-40 Mobile Speaker

Specifically designed for mobile operation to provide low distortion and high efficiency. Matches any car interior.

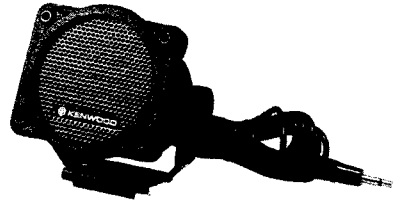

SP-40

■ Charger BC-1 (Part No. W09-0005-05)

This charger is used as a Back-up power supply when the main power supply is off for extended periods. This may remain connected at all times.

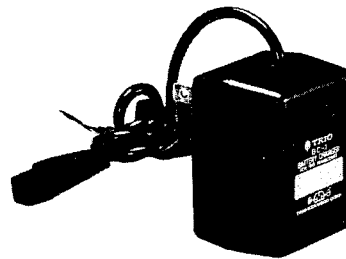

BC-1