

# ALINCO



## VHF/UHF FM Transceiver

# DJ-CRX7

## Instruction Manual

Thank you for purchasing your new Alinco transceiver. Please read this manual carefully before using the product to ensure full performance, and keep this manual for future reference as it contains information on after-sales service.

In case addendum or errata sheets are included with this product, please read those materials and keep them together with this instruction manual for future reference.

Manufacturer

**ALINCO, INC.**

Yodoyabashi Dai-bldg 13F

4-4-9 Koraibashi, Chuo-ku, Osaka 541-0043 Japan

Phone: +81-6-7636-2362 Fax: +81-6-6208-3802

<http://www.alinco.com>

E-mail: [export@alinco.co.jp](mailto:export@alinco.co.jp)



Copyright Alinco, Inc. PS0974 / FNEM-NM

Printed in China

## **Introduction**

**Please read this manual completely from the first page to the last, to learn all the functions the product offers. It is important to note that some of the operations may be explained in relation to information in other chapters. By reading just one part of the manual, you may risk not understanding the complete explanation of the function.**

## **Before transmitting**

There are many radio stations operating in proximity to the frequency ranges this product covers. Be careful not to cause interference when transmitting around such radio stations.

### **■ Lightning**

Any person is not safe outdoor during thunderstorm and lightning. This condition is getting worse if somebody keeps a hand-held radio; chances of being hit by lightning are doubled since lightning may hit a radio antenna as well. At this time, there is no hand-held radio having any kind of protection against lightning current (which is higher than 10 kA.). Note also that no car provides adequate protection of its passengers or drivers against lightning as well. Therefore, Alinco will not take responsibility for any danger associated with using its hand-held radios outdoor or inside the car during lightning.

## ■ Covering ranges

You may expect a range of approx.3km/2 miles or more at high-power when located on a flat, noise-free place like on a beach. However, it may vary drastically depending on how to wear and carry the radios, surrounding locations/conditions and static noise levels (below or near power transmission lines), etc. In urban areas with many buildings or inside a building, such covering range may become drastically short even to several tens of meters.

## ■ IMPORTANT NOTICE / DEALER PROGRAMMING

The utility software may be available to distributors/dealers only. USB programming cable is required. The manufacturer will not release the software to unauthorized party so please contact your dealer for details.







This product may be delivered to the consumer after being preprogrammed with the operating parameters, then certain operation may be disabled for user-accesses. This is the Commercial radio mode, and it may not work as described in this booklet. The manufacturer and distributors are not aware of details of such dealer-programming. Therefore, please contact to your dealer in case any technical assistance may be necessary.

## **Features**

- **Output power selectable VHF (5W/2W/1W), UHF (4W/2W/1W)**
- **200 PC-programmable channels**
- **Li-Ion battery pack and stand-charger as standard accessories**
- **Alphanumeric name tags**
- **FM broadcast 76-108MHz receiver built-in**
- **Selectable Battery-save parameters**
- **Busy Channel Lockout**
- **CTCSS/DCS Encode/Decode, DTMF**
- **VOX built-in**
- **Emergency, Alarm signal, Various scan modes, Key lock, Wide/Narrow operations and more.**









## WARNING



To prevent any hazard during operation of Alinco's radio product, in this manual and on the product you may find symbols shown below. Please read and understand the meanings of these symbols before starting to use the product.

 Danger	This symbol is intended to alert the user to an immediate danger that may cause loss of life and property if the user disregards the warning.
 Alert	This symbol is intended to alert the user to a possible hazard that may cause loss of life and property if the user disregards the warning.
 Caution	This symbol is intended to alert the user a possible hazard that may cause loss of property or injure the user if the warning is disregarded.
	Alert symbol. An explanation is given.
	Warning symbol. An explanation is given.
	Instruction symbol. An explanation is given.





## Alert

### ■ Environment and condition of use



-  Use of this product may be prohibited or illegal outside of your country. Be informed in advance when you travel.
-  It is recommended that you check local traffic regulations regarding the use of a radio equipment while driving. Some countries prohibit or apply restrictions for the operation of radios and mobile-phones while driving.
-  Do not use this product in close proximity to other electronic devices, especially medical ones. It may cause interference to those devices.
-  Keep the radio out of the reach of children.
-  In case a liquid leaks from the product, do not touch it. It may damage your skin. Rinse with plenty of cold water if the liquid contacted your skin.
-  Never operate this product in facilities where radio products are prohibited for use such as aboard aircraft, in airports, in ports, within or near the operating area of business wireless stations or their relay stations.
-  The manufacturer declines any responsibilities against loss of life and/or a property due to a failure of this product when used to perform important tasks like life-guarding, surveillance, and rescue.
-  Do not use multiple radios in very close proximity. It may cause interference and/or damage to the product(s).
-  Risk of explosion if battery is replaced with an incorrect type. Dispose of, or recycle used batteries according to your local regulations.

-  The manufacturer declines any responsibilities against loss of life and property due to a failure of this product when used with or as a part of a device made by third parties.
-  Use of third party accessory may result in damage to this product. It will void our warranty for repair.



## ■ Handling this product

-  Be sure to reduce the audio output level to minimum before using an earphone or a headset. Excessive audio may damage hearing.
-  Do not open the unit without permission or instruction from the manufacturer. Unauthorized modification or repair may result in electric shock, fire and/or malfunction and voids warranty.
-  Do not operate this product in a wet place such as in a shower room. It may result in electric shock, fire and/or malfunction. This product is splash-proof but not a complete water-proof.
-  Do not place the product in a container carrying conductive materials, such as water or metal in close proximity. A short-circuit to the product may result in electric shock, fire and/or malfunction.

## ■ About chargers

-  Do not use adapters other than having the specified voltage. It may result in electric shock, fire and/or malfunction. Never turn on the radio while charging.
-  Do not plug multiple devices using an adapter into a single wall outlet. It may result in overheating and/or fire.
-  Do not handle adapter with a wet hand. It may result in electric shock.



-  Securely plug the adapter into the wall outlet. Insecure installation may result in short-circuit, electronic shock and/or fire.
-  Do not use the adapter if the plug or socket contacts are dirty. Overheating and/or short-circuiting may result in fire, electric shock and/or damage to the product.

## ■ In case of emergency

In case of the following situation(s), please turn off the product, switch off the source of power, then remove or unplug the power-cord. Please contact your local dealer of this product for service and assistance. Do not use the product until the trouble is resolved. Do not try to troubleshoot the problem by yourself.

- **When a strange sound, smoke and/or strange odor comes out of the product.**
- **When the product is dropped or the case is broken or cracked.**
- **When a liquid penetrated inside.**
- **When a power cord (including DC cables, AC cables and adapters) is damaged**









-  For your safety, turn off then remove all related AC lines to the product and its accessories from the wall outlet if a thunderstorm is likely.

## ■ Maintenance

-  Do not open the unit and its accessories. Please consult with your local dealer of this product for service and assistance.





## Caution

### ■ Environment and condition of use

-  Do not use the product in proximity to a TV or a radio. It may cause interference or receive interference.
-  Do not install in a humid, dusty or insufficiently ventilated place. It may result in electric shock, fire and/or malfunction.
-  Do not install in an unstable or vibrating position. It may result in electric shock, fire and/or malfunction when/if the product falls to the ground.
-  Do not install the product in proximity to a source of heat and humidity such as a heater or a stove. Avoid placing the unit in direct sunlight.
-  Be cautious of a dew formation. Please completely dry the product before use when it happens.
-  Electronics devices such as solar panels and LED light bulbs may generate high levels of RF noise that may cause an interference. This is not a defect of receiver circuits of our product.
-  Turn off the radio before entering any area with a potentially explosive atmosphere or blasting caps.
-  Do not operate the radio, disassemble or charge the battery in the potentially flammable and explosive atmosphere ( such as gas station, coal gas station, etc).

### ■ About transceiver

-  Be cautious of the whip antenna when carried in your shirt-pocket etc. It may make contact with your eye and cause injury.

-  Do not connect devices other than specified ones to the jacks and ports on the product. It may result in damage to the devices.
-  Turn off and remove the power source (AC cable, DC cable, battery, cigar cable, charger adapter etc.) from the product when the product is not in use for extended period of time or in case of maintenance.
-  Never pull the cord alone when you unplug AC cable form the wall outlet.
-  Use a clean, dry cloth to wipe off dirt and condensation from the surface of the product. Never use thinner or benzene for cleaning.



Check with your local waste officials for details on recycling or proper disposal of the electronics product, battery-packs and accessories in your area.

Copyright © All rights reserved. No part of this document may be reproduced, translated or transcribed in any form or by any means without the prior permission of Alinco. Inc., Osaka, Japan. Alinco and ALINCO logo are registered trademarks of Alinco incorporated, Japan in United States, EU States, Russia, China and many other countries. Windows is a registered trademark of Microsoft Corporation in the United States and other countries. All other trademarks are the properties of their respective holders. ALINCO and authorized dealers are not responsible for any typographical errors there may be in this manual. The contents of this manual may be updated without any notice or obligation. Alinco cannot be liable for pictorial or typographical inaccuracies. Changes or modifications not expressly approved by the party responsible for compliance could void the user's authority to operate the equipment.

# ◦ TABLE OF CONTENTS

<b>STANDARD ACCESSORIES</b> .....	01
Standard Accessories.....	01
<b>BATTERY INFORMATION</b> .....	02
Charging Operation.....	02
Battery Charger Type.....	02
Notice for Charging Battery.....	02
How to Charge.....	04
How to Store the Battery.....	05
<b>PREPARATION</b> .....	06
Installing/Removing the Battery.....	06
Installing/Removing the Antenna.....	06
Installing/Removing the Belt Clip.....	07
Installing Optional Microphones.....	07
<b>GETTING ACQUAINTED</b> .....	08
LCD Display.....	08
<b>BASIC OPERATIONS</b> .....	11
Turn the Radio On & OFF.....	11
Adjusting Volume.....	11
Switch between Main band and Sub band.....	11
Switch between Channel mode and VFO mode.....	12
Channel Adjusting.....	12
Frequency Adjusting.....	12
Receiving.....	13

Transmitting.....	13
Side Key [PF1]/[PF2] Function.....	13
MONI Key Function.....	14
Edit Channel.....	14
Delete Channel.....	15
Programmed Scanning.....	15
Turn On/Off FM Radio.....	16
FM Channel Searching.....	16
CTCSS/DCS Setup.....	16
CTCSS/DCS Scan.....	17
Offset Frequency Direction Setup.....	17
Frequency/Channel Scan.....	18
Channel Scan Skip.....	18
Frequency Reverse.....	19
TX Power Selection.....	19
DTMF code Transmit and Enquiry.....	19
Keypad Lock.....	20
Stopwatch Function.....	20
<b>Function Menu Setup.....</b>	<b>21</b>
Menu Shortcut Function.....	26
Factory Default Setting.....	27
CTCSS/DCS Encode Setup.....	28
CTCSS/DCS Decode Setup.....	28

## ◦ TABLE OF CONTENTS

CTCSS/DCS Encode / Decode Synchronous Setup.....	29
Add or Cancel DTMF Signaling.....	29
Signaling Combination.....	30
Frequency Step.....	30
Wide/ Narrow FM Mode.....	31
Frequency Reverse.....	31
Talk Around.....	32
Offset Frequency.....	32
Editing Channel Name.....	33
Busy Channel Lockout.....	33
Prohibits Transmitting.....	34
Scrambler Setup (Encryption).....	34
Voice Comander.....	35
Band Limit.....	35
Sub Band Display.....	36
Beep Sounds.....	36
Time-Out-Timer (TOT).....	37
Voice Operated Transmission (VOX)/(An optional earphone-microphone is necessary).....	37
Voice Operated Transmission (VOX) Delay Time.....	38
Automatic Power Off Time.....	38
DTMF Transmitting Time.....	39
Squelch Level.....	39

Scan Dwell Time .....	40
Function Icon Stay Time.....	40
LCD Backlight.....	41
LCD Backlight Color.....	42
Self ID inquiry .....	42
Tone Burst Frequency .....	43
Battery Save.....	43
FM Radio .....	44
PF1 and PF2 Key Function .....	45
Display Mode Setup .....	45
Resume Factory Default .....	46
<b>AUXILIARY FUNCTIONS</b> .....	47
Cable Cloning.....	47
Cable Cloning Instruction .....	48
<b>OPTIONAL ACCESSORIES</b> .....	49
<b>RECOMMENDED INSTALLATION OF EARPHONE MICROPHONE</b> .....	50
<b>TECHNICAL SPECIFICATION</b> .....	51
<b>TROUBLE SHOOTING GUIDE</b> .....	52
<b>ATTACHED CHART</b> .....	53
CTCSS Frequency Chart.....	53
1024 groups DCS Frequency Chart.....	54

## ◦ STANDARD ACCESSORIES

### Standard Accessories

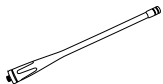

Antenna  
EA-277

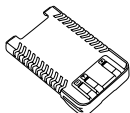

Li-ion Battery  
EA-107

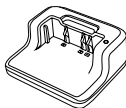

Battery Charger  
EDC-314

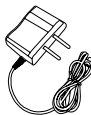

AC Adaptor  
EDC-191E

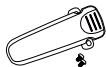

Belt Clip  
EBC-41

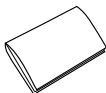

Instruction  
Manual



Hand Strap

**NOTE:** Accessories may differ depending on the version you have purchased. Please contact your local dealer for details of standard accessories and the warranty-policy before purchase.



### ((( Charging Operation

The battery is not charged at the factory, please charge it before use. Charge the battery for the first time after purchase or extended storage (more than 2 months) may not bring the battery to its normal operating capacity. After repeating fully charge/discharge cycle for two or three times, the operating capacity will reach the best performance. The battery life is over when its operating time decreases even though it is fully and correctly charged and it must be replaced to a new one.

### ((( Battery Charger Type

Please use our ALINCO's designated charger, other models may cause explosion. After installing the battery, when the radio displays  low battery, please charge the battery.

### ((( Notice for Charging Battery

- ▲ Do not shortcircuit the charger. Never attempt to remove the casing from the battery, otherwise the warranty is void and you risk serious damage to yourself and properties.
- ▲ The ambient temperature should be between 5°C and 40°C while charging. Charging outside this range may not fully charge the battery.
- ▲ Always switch off the transceiver before charging. Otherwise, it may not charge correctly.
- ▲ To avoid interfering the charging procedure, please do not cut off the power or take out the battery during charging.
- ▲ Do not recharge the battery if it is already fully charged. This may shorten the life of the battery or damage the battery.
- ▲ Do not charge the battery or transceiver if it is damp. Dry it before charging to avoid danger.

## ○ BATTERY INFORMATION

### Caution

- Risk of explosion, generation of heat or leak of chemicals inside if the battery is replaced by an incorrect type or reverse polarity. Use always the recommended types of batteries in this manual only.
- The battery pack isn't fully charged when shipped. It must be charged before use.
- Charging should be conducted in a temperature range of +5°C to +40°C (+41°F to +104°F).
- Don't modify, dismantle, incinerate or immerse the battery pack in the water as this can be dangerous.
- Never short-circuit the battery pack terminals, as this can cause damage to the equipment or lead to heating of the battery which may cause burns.
- Unnecessary prolonged charging (overcharging) can deteriorate battery performance.
- The battery pack should be stored in a dry place where temperature is in -10°C to +45°C (-14°F to +113°F) range. Temperatures outside this range can cause the battery liquid to leak. Exposure to prolonged high humidity can cause corrosion of metal components.
- Battery-packs are a consuming part. When its operating time becomes considerably short after a normal charge, please consider that the pack is exhausted and replace it with a new one.
- The battery pack is recyclable. Check with your local waste officials for details on recycling options or proper disposal in your area.
- Use specified genuine chargers only to charge battery packs. Use of other chargers may cause damage to products, you and your property.
- Never carry battery packs together with conductive articles such as metals in a same bag to prevent from short-circuiting. Put the packs only in nylon bags to carry them safely.
- Even if you do not use the battery pack for a long time, charge it at least once every three months to prevent deterioration.

### How to Charge

1. Plug the AC adaptor into the AC outlet(100V-240V), then plug the cable of AC adaptor into the DC jack, the indicator lights RED on for 1 second then turns to GREEN on---waits to charge.
2. Slide the battery or transceiver with battery into the charger; make sure the battery terminals are in contact with the charging terminals. LED turns from GREEN to RED on---charging.
3. It takes about 4 hours to fully charge the battery, and LED turns to GREEN when the charge is complete.

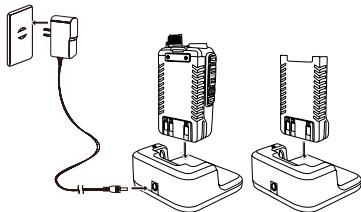

**Warning: Never charge while the radio is turned on. When turned on, the charger can't detect the charging voltage properly and LED fails to indicate charge status correctly.**

#### NOTE:

- ▲ Trouble means battery heating, short-circuit or charger malfunction. Remove the battery pack from the charger immediately and contact to your local dealer for services.
- ▲ The max trickle pre-charging time is 30 minutes. In case the red indicator continues to blink longer, please stop charging and consult with your local dealer for services.
- ▲ It is known that Li-Ion battery packs heat up over 400°C by itself when kept in a temperature of over 80°C for extended period of time. Although the packs are protected against overheating with a protective circuit, never leave the battery packs in a car or similar locations in hot seasons.
- ▲ Li-ion packs may deteriorate by over 30% regardless of conditions after 3 years. This is a nature of Li-Ion pack and not a defect of the product.

## ◦ BATTERY INFORMATION

- ▲ The charger is to charge the battery pack only. It is not an AC adapter to operate the radio. Never attempt to transmit the radio with using the charger as it will cause the damage to the charger and a repair/replace may become necessary.
- ▲ The charge should be conducted in an ambient temperature with a proper air-conditioning in an extremely hot or cold seasons.
- ▲ Try charging the battery pack only when having trouble charging with the radio. In case the radio may have troubles, the charge can't be conducted properly. If the battery pack can be charged alone, please take the radio to your local dealer for services.

### ((( How to Store the Battery

1. The battery should be kept in the status of 50%-100% charged when storing.
2. It should be kept in cool, dry environment and remove it from the transceiver.
3. Keep away from source of heat and direct sunlight.

#### WARNING

- ▲ **Do not short-circuit battery terminals.**
- ▲ **Never attempt to remove the casing from the battery pack.**
- ▲ **Never assemble the battery hazardous in explosive atmosphere as, spark may cause explosion.**
- ▲ **Do not put the battery in hot environment or throw it into fire, it may also cause explosion.**

**Note : Battery pack discharges faster when it is attached to the radio. Please always remove it from the radio when not in use.**

## ◦ PREPARATION

# ALINCO

### ((( Installing / Removing the Battery

#### ■ Installing the Battery

Align the catches on the unit with the grooves on the battery pack, slide the pack forward and close the latch until it clicks.

#### ■ Removing the Battery Pack

Push the latch in the direction of the arrow, and pull out the battery pack.

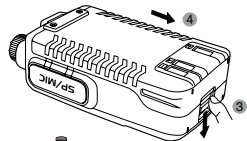
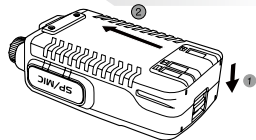

### ((( Installing / Removing the Antenna

#### ■ Installing the Antenna:

Screw the antenna into the connector on the top of the transceiver by holding the antenna at its base and turning it clockwise until secure.

#### ■ Removing the Antenna:

Turn the antenna anticlockwise till the antenna separates the connector of the transceiver to remove it.

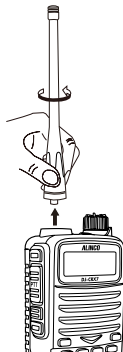

**NOTE: Do not use third-party antenna as it may radiate more RF that exceeds SAR limit guidances.**

## ◦ PREPARATION

### ((( Installing / Removing the Belt Clip(Optional)

Place the belt clip to the screw holes on the back of the transceiver, and fix it by provided screws.

Do the opposite to remove

Check the tightness of the fixing screws from time to time.  
(screws size 2.5 x 5mm).

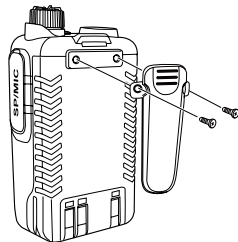

### ((( Installing Optional Microphones

Unveil the MIC-SP jack cover and insert the Microphone plug into MIC-SP jack.

#### **NOTE:**

- 1. To keep the radio dust and splash resistant, the cover must be closed properly with the original supplied cover.**
- 2. The radio is not dust and splash resistant while using the optional accessory risking that the water may penetrate inside through the plug.**

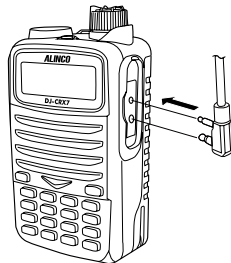

📶 **LCD Display**

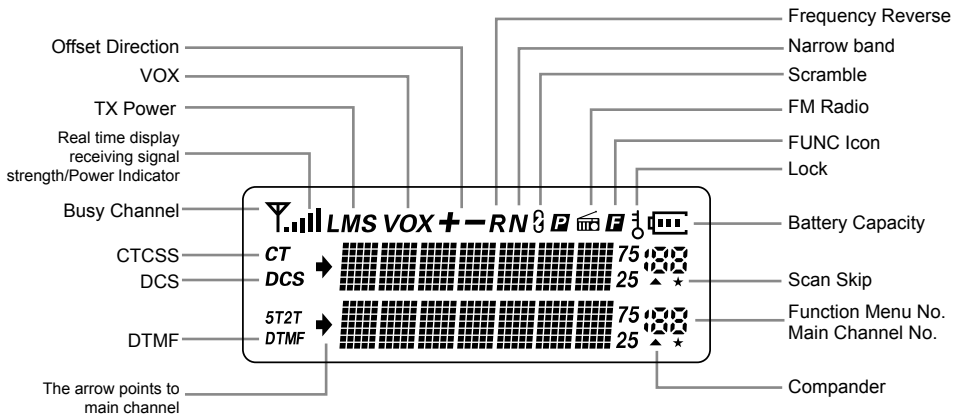

**NOTE:**

- 🔋 **Battery capacity indicator(full)** 🔌 **No power, replace battery pack or charge battery**
- 🔋 🔌 **Battery capacity remnant**

## ◦ GETTING ACQUAINTED

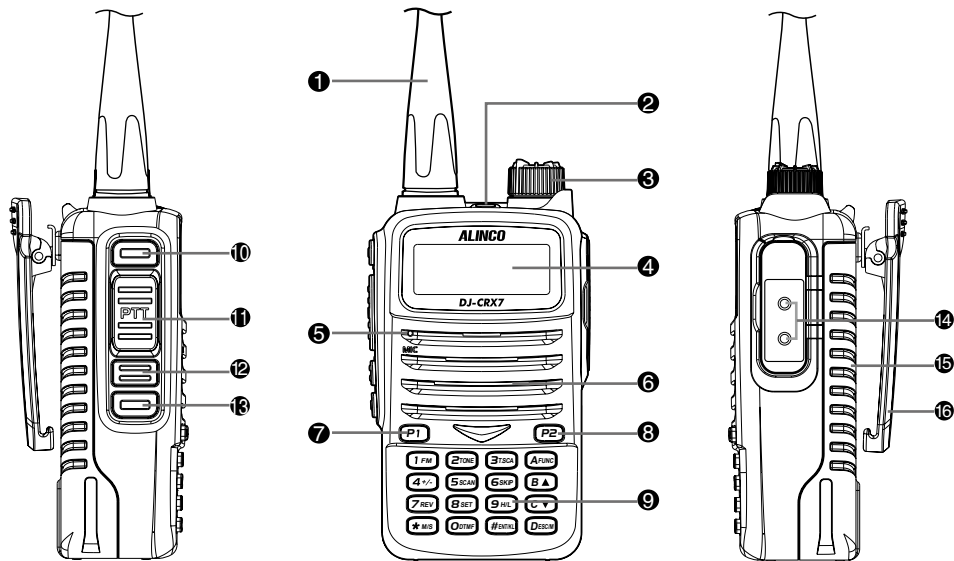

**NOTE:** Please do not close the microphone hole.



- ❶ Antenna
- ❷ TX/RX indicator, RX is Green, TX is Red
- ❸ Power / Volume Switch  
Rotate it clockwise to turn on transceiver, rotate it anticlockwise until clicks to turn off the transceiver.  
When transceiver is powered, rotate it clockwise to increase volume, anticlockwise to reduce.
- ❹ LCD display: Displays current frequency/channel and operations
- ❺ Mic
- ❻ Speaker
- ❼ P1 key: Programmable menu setting key, quickly enter the current programming menu. Scrambler setup is assigned as default function.
- ❽ P2 key: Programmable menu setting key, quickly enter the current programming menu. Voice compander is assigned as default function.
- ❾ Keypad: Enters desired frequency/channel or operations by keypads
- ❿ PF1: Programmable function key, battery voltage query is assigned as default function.
- ⓫ PTT key: Press PTT key to talk, release this key to receive.
- ⓬ PF2: Programmable function key, emergency alarm is assigned as default function.
- ⓭ MONI key
- ⓮ Speaker/Microphone jack, programming software jack
- ⓯ Battery
- ⓰ Belt Clip

## ◦ BASIC OPERATIONS

### ((( Turn the Radio On & OFF

Under power-on state, please turn [POWER]/[VOLUME] anticlockwise till hearing "Click" to turn off the transceiver. A beep sounds and displays channels or frequencies.

Under power-off state, please turn [POWER]/[VOLUME] clockwise to turn off the transceiver.

### ((( Adjusting Volume

Under power-on state, turn [POWER] / [VOLUME] to adjust volume. Clockwise-up, anticlockwise -down.

**NOTE:** Press the side key programmed as Squelch Off Momentary to monitor the background noise. Turn [POWER]/ [VOLUME] to adjust the level by listening to the noise sound.

**NEVER USE EARPHONE** while adjusting audio level. The max audio output is 1W, and it's loud enough to hurt your eardrums.

You may feel a static shock when wearing an earphone in a dry atmosphere but it's not a defect of product but a cause of nature. It is the same shock you feel typically when opening a door of a car in certain conditions.

### ((( Switch Between Main Band and Sub Band

Under standby state, press  key to switch channel between Main band and Sub band. The main band is shown with an arrow icon on the left.

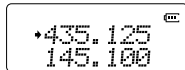

### ((( Switch between Channel Mode and VFO Mode

Under standby state, press (DESCM) key to set main band as Channel mode or frequency mode(VFO).

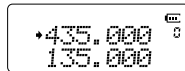

### ((( Channel Adjusting

1. When transceiver in Channel mode or FM radio channel mode, press key (B▲) / (C▼) to adjust channel. Press (B▲) to enter the upward channel, Press (C▼) to enter the downward channel. If there is blank channel between two channels, radio will skip blank channels.

2. Input channel number by keypad

When transceiver is in Channel mode or FM radio channel mode, user can input number(000-199) to switch into desired channel. If input channel number is not belong to unprogrammed channel, radio will emit wrong prompt voice to return current channel. 001 means channel 1, 030 is channel 30, 125 is channel 125.

### ((( Frequency Adjusting

When transceiver in VFO mode or FM radio frequency mode, rotate (B▲) / (C▼) to adjust frequency or input frequency by keypad.

1. Press (B▲) to increase frequency, Press (C▼) to decrease frequency. Every rotate can add or reduce one stepping value.

**NOTE: Channel step:2.5K, 5K, 6.25K, 10K, 12.5K, 20K, 25K, 30K and 50KHz in total 9 for optional. FM radio step frequency is 50K.**

## ◦ BASIC OPERATIONS

2. Enter the desired frequency by keypad.

In VFO or FM VFO mode, you can directly input frequency by keypad.

**Example: To enter 435.0125, press [4][3][5][0][1][2] then 5 appears and sets automatically. To enter 435.100, press [4][3][5][1][0][0]. By pressing the last [0], a dot appears after the MHz unit and the frequency is set.**

### Receiving

when a signal is being received, the LED turns green and hear the call.

**NOTE: Please be aware of the squelch level and selective-calling settings such as CTCSS and DCS as you may risk not hearing the receiving signal.**

### Transmitting

Press and hold [MONI] key to monitor the channel to ensure it is not busy. Press and hold [PTT] key and talk to speaker. While transmitting, the LED turns red.

Please keep the distance between mouth and speaker to be 2.5-5Cm, speak in normal tone to get the best acoustic fidelity. Release the PTT to stop transmitting. The red LED turns off.

### Side Key [PF1]/[PF2] Function

These are programmable keys. You can assign the desired functions by both transceiver setting and by PC software. See page 45 for instructions. Detailed setting may require a PC programming.

1. **VOLT:** Battery capacity inquiry, assign this function to display battery level.

2. **CALL:** Assign this function to transmit the prestored DTMF Encode signal in channel. By other combination key, press and hold [PTT] then press [MONI] key to transmit DTMF code.
3. **ALARM:** Assign this function to enable the ALARM function. Under standby state, press and hold [PF1] or [PF2] key which is programmed with ALARM function until LCD displays "**ALARM**", Emergency alarm function is started. This transceiver has 3 Alarm modes for optional, can be setup in programming software. Press and hold the key or power off to exit alarm.
4. **Transmit tone burst frequency:** Press and hold [PTT] key, then press [PF1]/[PF2] key to transmit selected tone burst frequency. The tone burst frequency can be set to 1000Hz / 1450Hz/1750Hz / 2100Hz.

### ((( MONI Key Function

Following functions can be assigned to the [MONI] key.

1. Squelch off: Press [MONI] key, you can hear background noise. Press [MONI] again, squelch is mute.
2. Monitor: Press and hold [MONI] key, you can hear background noise. Release [MONI], squelch is mute.
3. [MONI] key is also used to activate the function set mode, refer to P.46 for more detail.

### ((( Edit Channel

To store a frequency to a channel follow the below steps.

1. Under frequency mode (VFO), enter desired frequency, press **ARUNC** key, the top corner of LCD displays "**F**" icon, press **C▼** key to switch into channel mode, channel number flashes.

## ◦ BASIC OPERATIONS

2. Press **(B▲)** / **(C▼)** to select desired editing channel number.
3. Press **(A<sub>FUNC</sub>)** key, the top corner of LCD displays "**F**" icon, press and hold **(C▼)** key until a beep sounds, and channel is stored successfully. Repeat the same to overwrite the channel with different data, but overwrite protection is not available.

### Delete Channel

To delete a stored channel follow the below steps.

1. Under standby state, press **(A<sub>FUNC</sub>)** key, the top corner of LCD displays "**F**" icon, press **(B▲)** key to switch into channel mode, channel number flashes.
2. Press **(B▲)** / **(C▼)** to select desired deleting channel number.
3. Press **(A<sub>FUNC</sub>)** key, the top corner of LCD displays "**F**" icon, press and hold **(B▲)** key until a beep sounds, and clear up frequency information of current channel, deletion is successful.

### Programmed Scanning

This is a type of VFO scan, and scans only the designated frequency range set into the L1/U1 and L2/U2 channel pairs in the memory mode. This feature is referred to as also "Search" and 2 pairs available. Both channel pairs can be set freely in the VHF and UHF bands, but the pair channels must be within the same band. Follow the memory edit instruction to store the lower and upper frequency settings in the L(lower) and U(upper) pair channels. To scan, in the VFO mode, select a frequency within the scanning range. Press "**(A<sub>FUNC</sub>)**" key. LCD displays "**F**" icon on the upper right corner. Press "**(S<sub>SCAN</sub>)**" key to start scanning. When starts scanning from the off-range frequency, it scans whole receiving range like a normal VFO scan.

### ☞ Turn On/ Off FM Radio

Under standby state, press **A** key, the top corner of LCD displays " **F** " icon, then press **1** key, LCD displays " **FM ON** " and current FM radio frequency, FM radio function is on. Press **B** / **C** key to adjust the FM radio frequency.

To turn off FM radio, press **\*M/S** key, LCD displays " **FM OFF** ", FM radio is mute.

Or press **A** key, the top corner of LCD displays " **F** " icon, press **1** key to turn off FM radio and return to standby state.

When FM radio is on, Re-start transceiver, FM radio function will still on.

You can listen to the FM radio in the background (any incoming call will silence the FM radio) by pressing **#ENTR** key.

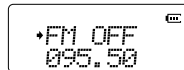
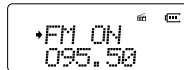

### ☞ FM Channel Searching

When transceiver in FM radio mode, press **A** key, LCD displays " **F** " icon, then press **S** to start FM searching. When one station is sought, LCD displays current station frequency, you can listen to current station.

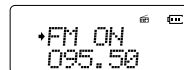

### ☞ CTCSS/DCS Setup

Under standby state, press **A** key, the top corner of LCD displays " **F** " icon, press **Z** key, LCD displays " **CT** " icon, it means current channel add CTCSS signal function. Repeat above operation, LCD displays " **DCS** " icon, it means current channel add DCS signal function. Repeat above operation, " **DCS** " icon disappears, current channel without CTCSS/DCS signal. For detail setting refer to page 28.

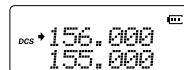
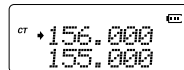

## ◦ BASIC OPERATIONS

### ((( CTCSS/DCS Scan

While in the CTCSS or DCS mode, Press **[A/FUNC]** key, the top corner of LCD displays " **F** " icon, press **[T/SCA]** key to enter into CTCSS/DCS scan. Under this state, press **[B/▲]** / **[C/▼]** to change scan direction. When transceiver catches the matching CTCSS/DCS signaling, it will stay 5seconds and then go on scanning. Press any other keys except **[A/FUNC]**, **[\*M/S]**, **[#ENT/K]** key to exit.

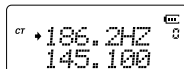

CT 186.2HZ  
145.100



DCS 063.N  
145.100

**NOTE: This function is invalid when the main channel is in channel display mode or current mode without signaling setup. Scan CTCSS when the current channel is set to CTCSS, scan DCS when the channel is set to DCS.**

### ((( Offset Frequency Direction Setup

In VFO mode, Under standby state, press **[A/FUNC]** key, the top corner of LCD displays " **F** " icon, press **[4+/-]** key to choose offset frequency direction. There are 2 options, Positive offset, Minus offset.

1. (+) Positive offset: Indicates TX frequency is higher than RX frequency. When enable reverse function, the RX frequency is higher than TX frequency.
2. (-) Minus offset: Indicates TX frequency is lower than RX frequency. When enable reverse function, the RX frequency is lower than TX frequency.
3. None: Indicates that offset is not in use.

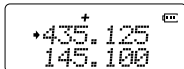

+435.125  
145.100

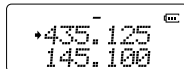

-435.125  
145.100

**NOTE: This function is invalid in channel mode.**



## ((( Frequency/Channel Scan

Under corresponding mode, press **[A FUNC]** key, the top corner of LCD displays " **F** " icon, then press **[S SCAN]** key to start frequency scan or channel scan.

### 1. Frequency Scan

Under VFO mode, this function is used for monitoring signal of various communication frequency by transceiver 'step' setup, (see the setting in menu 6). During scanning, press **[A FUNC]** key to adjust scanning speed, transceiver will switch MHz step or KHz step. press numeric key or **[DESCM]** key to exit.

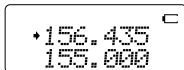

### 2. Channel Scan

Under channel mode, transceiver will scan all the stored channels. Press numeric key or **[DESCM]** key to exit.

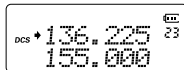

### NOTE:

- ▼ Frequency scan is of all bands scan, it scans upwards as your STEPPING setting.
- ▼ In channel scan, the skipped channel is not in the line of scanning. Scan upwards as per channel no. (please refer to channel scan skip).
- ▼ Frequency/channel scan can change scan direction by press **[B ▲]** / **[C ▼]**, when find a matching carrier wave and signaling, the transceiver will stay 5 seconds then go on scanning. (Please refer to scan setup)

## ((( Channel Scan Skip

Under channel mode, press **[A FUNC]** key, the top corner of LCD displays " **F** " icon, then press **[S SKIP]** key to set the current channel as Channel scan skip. Repeat above operation to cancel channel scan skip.

1. LCD displayed " ★ " means the current channel will not be scanned.
2. " ★ " icon disappeared means the current channel will be scanned.

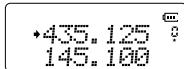

## ◦ BASIC OPERATIONS

### ((( Frequency Reverse

Under standby state, press **[A/FUNC]** key, the top corner of LCD displays "**F**" icon, then press **[7/REV]** key to set the current channel as frequency reverse, repeat above operation to turn off frequency reverse.

1. When LCD displays "**R**" icon, it means current channel enabled the frequency reverse function, the TX frequency and RX frequency is interchanged, if CTCSS/DCS signaling is set, it will also interchange.
2. When "**R**" icon disappears, it means reverse function is close.

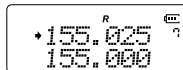

### ((( TX Power Selection

Under standby state, press **[A/FUNC]** key, the top corner of LCD displays "**F**" icon, then press **[9/HIL]** key to choose High/Low power for current channel.

1. When LCD displays "**L**" icon, it means low power is chosen.
2. When LCD displays "**M**" icon, it means Middle power is chosen.
3. When high power is selected the radio screen will not display "**L**" or "**M**".

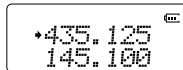
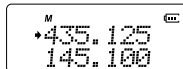
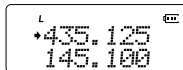

### ((( DTMF code Transmit and Enquiry

1. Press **[A/FUNC]** key, the top corner of LCD displays "**F**" icon, then press **[0/DTMF]** key, LCD displays DTMF data and group number (total 16 groups) of current group.
2. Press **[B/▲]** / **[C/▼]** to choose desired group and DTMF data, press [PTT] key to transmit selected DTMF signaling. If current group does not contain DTMF data, LCD displays the current group number and "**EMPTY**".

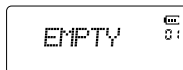

## ◦ BASIC OPERATIONS

# ALINCO

- When current group displays "EMPTY", press **A/FUNC** key, the top corner of LCD displays "F" icon, press and hold **O/DTMF** key until a beep sounds, and transceiver enters into DTMF edit state, LCD displays "\_\_\_\_\_", now you can enter desired DTMF data by keypad. DTMF data also can be created by PC programming.
- When finished editing, press side key [PF2] to save DTMF signaling.

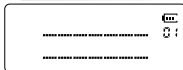

## ⦿ Keypad Lock

Under standby state, press **A/FUNC** key, the top corner of LCD displays "F" icon, then press and hold **#/ENTR** key until a beep sounds, and LCD displays "🔒" icon, keypad is locked. Repeat above operation, "🔒" icon disappears, key lock function is cancelled.

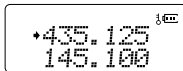

**NOTE: When keypad is locked, only PTT / PF1 / PF2 / **A/FUNC** key are usable.**

## ⦿ Stopwatch Function

- In standby state, press **A/FUNC** key, the top corner of LCD displays "F" icon, then press **★/M/S** to enter into stopwatch function.
- Press **★/M/S** key to start timing. Under this state, press **#/ENTR** key to pause timing. When timing is pause, press **★/M/S** key to continue timing.
- Press [PF1], [PF2], [MONI] or **D/DESC** key to exit stop watch function.

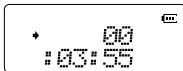

**NOTE: During timing, press **★/M/S** key to stop timing and displays current data, press this key again to clear timer. The timer only counts within 60 minutes then resets.**

## ○ FUNCTION MENU SETUP

Menu 1-15 of this transceiver are channel operations. Channel operations temporarily changed the functions of current channel. When power off or channel has been changed, the relevant setup will be erased. Only under VFO mode, the channel operations will be saved until next change. Menu 16-34 is background operation, it is valid for all channels, the relevant setup will be saved until next change.

The operating methods are as follows:

1. Press **(A<sub>FUNC</sub>)** key, the top corner of LCD displays " **F** " icon, then press **(B<sub>SET</sub>)** key to enter function menu.
2. Press **(B<sub>▲</sub>)** / **(C<sub>▼</sub>)** key to choose desired function. Press and hold **(B<sub>▲</sub>)** / **(C<sub>▼</sub>)** to move menu with a quicker speed.
3. Press **(A<sub>FUNC</sub>)** key to enter to the function menu and select the setting, LCD displays " **▶** " icon, press **(B<sub>▲</sub>)** / **(C<sub>▼</sub>)** to select desired setting.

**Note:**In CTCSS/DCS setting, Press **(1<sub>FM</sub>)** to select CTCSS, DCS or OFF. When select DCS press **(★<sub>M/S</sub>)** to switch between positive and negative code, In editing name, press **(1<sub>FM</sub>)** to move downward icon, press **(4<sub>+/-</sub>)** move upward icon.

4. Press **(A<sub>FUNC</sub>)** to return to the menu. Press **(B<sub>▲</sub>)** / **(C<sub>▼</sub>)** key to continue settings, or press **(DESCM)** or **(#ENTNL)** to confirm and exit.

**NOTE:** **(P1)**/**(P2)** key can be setup in programming software without operating the 1 method into Menu1-34.

## FUNCTION MENU SETUP

**ALINCO**

Menu No.	LCD Display	Function	Options	Description
1	T-CDC	CTCSS/DCS Encode	OFF	No CTCSS/DCS Encode
			62.5Hz-254.1Hz+Self defined	51 groups fixed CTCSS encode+1 group self-defined CTCSS encode
			000N-777I	1024 groups DCS Encode
2	R-CDC	CTCSS/DCS Decode	OFF	No CTCSS/DCS Decode
			62.5Hz-254.1Hz+Self defined	51 groups fixed CTCSS decode+1 group self-defined CTCSS decode
			000N-777I	1024 groups DCS decode
3	RT-CDC	CTCSS/DCS Encode/Decode Synchronous	OFF	No CTCSS/DCS encode/decode
			62.5Hz-254.1Hz+Self defined	51 groups fixed CTCSS encode/decode + 1 group self-defined CTCSS encode/decode
			000N-777I	1024 group DCS encode/decode
4	TONDEC	Optional signaling setup	DTMF	Current optional signal is DTMF
5	SIGNAL	Squelch mode setup	SQ	When current channel received matching RF signals, transceiver can hear the talking from the other party.
			CTCSS/DCS	When current channel received matching RF signals and matching CTCSS/DCS signaling, transceiver can hear the talking from the other party.
			TONE	When current channel received matching RF signals and matching optional signaling, transceiver can hear the talking from the other party.

## ○ FUNCTION MENU SETUP

5	SIGNAL	Squelch mode setup	CT&TO	When current channel received matching RF signals + matching optional signaling + matching CTCSS/DCS signaling, transceiver can hear the talking from the other party.
6	STEP	Frequency step size setup	2.5K-50K	9 options in total (VFO only)
7	W/N	Wide / Narrow Band Selection	WIDE/NARROW	Wide band/Narrow band
8	REV	Frequency Reverse	ON	Turn on Frequency reverse function, TX and RX frequency of current channel will be interchanged.
			OFF	Close Frequency reverse function.
9	TALKAR	Talk Around	TX=RX	Turn on Talk Around function, current channel will transmit by RX frequency, if CTCSS/DCS signaling is set, it will interchange decoding CTCSS/DCS as encoding.
			OFF	Close Talk Around function.
10	OFFSET	Offset Frequency setup	0-80MHz	Frequency range is 00-80MHz.
11	NAME	Editing Channel name	a~z / A~Z / 0~9 / : / ; / < / = / > / ? / @ / [ / ¥ / ] / ^ / _ / ' /	In channel name display mode, will display the edited channel name.
12	RPLOCK	Busy Channel Lockout	BUSY	Carrier wave lock, transmitting is prohibited when received matching carrier wave.
			REPEAT	Signaling lock, transmitting is prohibited when received matching carrier but with mismatching CTCSS/DCS
			OFF	Close BCLO function.

## ○ FUNCTION MENU SETUP

# ALINCO

13	TX	TX OFF	ON	TX function is enabled in current channel
			OFF	TX function is disabled in current channel
14	SCR	OFF	OFF	Turn of voice encryption
			1~11 + EDIT	The voice will be encrypted before transmitting
15	COMP	OFF	ON/OFF	Turn on compander to reduces background noise.
16	BAND	Band Limit	ON/OFF	Turn on/off band limit function
17	DSPSUB	Sub band display setup	FREQ	Display sub band frequency or channel
			VOLT	Display current battery voltage
			OFF	Sub band display is disabled
			RADIO	Display FM Radio frequency
18	BEEP	Keypad Voice prompt setup	ON/OFF	Turn on/off keypad voice prompt function
19	TOT	Time-Out-Timer	OFF	Turn off time-out timer
			10-270 S	Total 27 levels for optional, each interval is 10 S
20	VOX	Voice Operated Transmission (VOX) Setup	OFF	Turn off VOX function
			1-10	Total 10 VOX levels for optional
21	VDELAY	VOX Delay Setup	0.5S-3S	Total 27 levels for optional, each interval is 0.1S

## ○ FUNCTION MENU SETUP

22	APO	Automatic Power Off Setup	OFF	Disable the Automatic power off function
			30 MIN-2 Hours	30minutes ~ 2hours: Total 3 levels for optional
23	DTMF	DTMF Transmitting Time	50MS-500MS	Total 5 kinds of DTMF transmitting time for optional
24	SQL	Squelch level Setup	00-09	10 levels of squelch in total for optional, "00" is minimum setup value (normally open)
25	SCAN	Scan Dwell Time Setup	5ST-15ST	When scanning matched signal, transceiver will stop scanning for 5-15seconds then resume.
			2SP	When scanning matched signal, transceiver will stop scanning, 2seconds after signal disappeared, then resume.
26	FTIME	Function Icon Stay Time	FUNCT	When finished function setting or enter into function menu, icon disappeared.
			1SEC-3SEC	When finished function setting or enter into function menu, icon stay 1-3seconds then disappeared.
			ALWAYS	Function icon is always display, only when pressing function key again, the icon will disappear.
27	LIGHT	LCD Backlight	ON/OFF	Always on/off
			AUTO	Backlight will automatic closed after a period.
28	COLOR	LCD Backlight Color	BLUE/ORG/PUR	Blue/Orange/Purple
29	ID	Self ID inquiry	ID	LCD displays radio self ID, DTMF ID is 3 digits.



30	TBST	Tone Pulse Frequency Selection	1750Hz/2100Hz/1450Hz/1000Hz	Tone plus frequency is 1750Hz/2100Hz/1450Hz/1000Hz
31	SAVE	Battery Save Setup	OFF	Turn off battery save function.
			1:2-1:8	Battery save time is 1:2-1:8
			AUTO	Battery save ratio is adjusting automatically.
32	RADIO	FM radio	ON/OFF	Allow/Prohibit using FM radio.
33	PF1	Self define PF1/ PF2 key function	VOLT	Displays current battery capacity.
			CALL	Call function.
			ALARM	Emergency alarm function.
34	PF2		OFF	No function.

### ☞ Menu Shortcut Function

User can assign a desired menu in the setting menu to **(P1)** and **(P2)** key by PC software. When press the **(P1)**/**(P2)** key transceiver will display menu as a shortcut way.

## ◦ FUNCTION MENU SETUP

### ((( Factory default Setting

Menu No.	LCD Display	Default
1	T-CDC	OFF
2	R-CDC	OFF
3	RT-CDC	OFF
4	TONDEC	OFF
5	SIGNAL	SQ
6	STEP	12.5K
7	W/N	25K
8	REV	OFF
9	TALKAR	OFF
10	OFFSET	5MHz
11	NAME	--
12	RPLOCK	OFF
13	TX	ON
14	SCR	OFF
15	COMP	OFF
16	BAND	OFF
17	DSPSUB	FREQ

Menu No.	LCD Display	Default
18	BEEP	ON
19	TOT	60S
20	VOX	OFF
21	VDELAY	0.5SEC
22	APO	OFF
23	DTMF	50MS
24	SQL	3
25	SCAN	5ST
26	FTIME	FUNCT
27	LIGHT	AUTO
28	COLOUR	ORG
29	ID	001
30	TBST	1750Hz
31	SAVE	AUTO
32	RADIO	ON
33	PF1	VOLT
34	FP2	ALARM

### CTCSS/DCS Encode Setup

1. After pressing **A** key, the top corner of LCD displays "**F**" icon then press **B** key.
2. Press **B** / **C** key to choose menu 01 and display "T-CDC".
3. Press **A** enter into next menu, LCD displays "➡" icon, press **B** / **C** to select desired setting.
4. Press **I** key to choose the desired CTCSS / DCS encoding tone. See appendix for details of available tones.
5. Press **D** key or **#** key to confirm and exit or press **A** key then **B** / **C** key to continue.

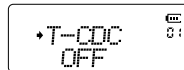

### CTCSS/DCS Decode Setup

By using this function with CTCSS/DCS encode feature, you hear only signals that are sent with matching tones (CTCSS or DCS).

1. After pressing **A** key, the top corner of LCD displays "**F**" icon then press **B** key.
2. Press **B** / **C** key to choose menu 02 and display "**R-CDC**".
3. Press **A** enter into next menu, LCD displays "➡" icon, press **B** / **C** to select desired setting.
4. Press **I** key to choose the desired CTCSS / DCS decodeing tone. See appendix for details of available tones.
5. Press **D** key or **#** key to confirm and exit.

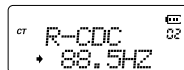
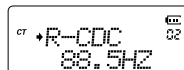

## ○ FUNCTION MENU SETUP

**NOTE:** You may set the encoding and decoding tones separately.

### ⏪ CTCSS/DCS Encode / Decode Synchronous Setup

This function is for adjusting CTCSS/DCS encode/decode synchronous.

1. After pressing (A/FUNC) key, the top corner of LCD displays "F" icon, then press (B/SET) key.
2. Press (B▲) / (C▼) key to choose menu 03 and display "RT-CDC".
3. Press (A/FUNC) key enter into next menu, LCD displays "➡" icon, press (B▲) / (C▼) to select desired setting.
4. Press (1/FM) key to choose the desired CTCSS / DCS encoding/decoding tone. See appendix for details of available tones.
5. Press (DESCM) key or (#/ENTNL) key to confirm and exit.

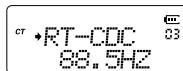

### ⏪ Add or Cancel DTMF Signaling

This function is DTMF setting

1. After pressing (A/FUNC) key, the top corner of LCD displays "F" icon, then press (B/SET) key.
2. Press (B▲) / (C▼) key to choose menu 04 and display "TONDEC".
3. Press (A/FUNC) key enter into next menu, LCD displays "➡" icon, press (B▲) / (C▼) to select desired setting.  
**DTMF:** current optional signaling is DTMF  
**OFF:** close optional signaling
4. Press (DESCM) key or (#/ENTNL) key to confirm and exit.

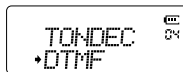
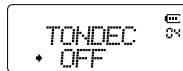

## ⦿ Signaling Combination

You may combine the signaling functions of different system.

1. After pressing **[A/FUNC]** key, the top corner of LCD displays " **F** " icon, then press **[B/SET]** key.
2. Press **[B▲]** / **[C▼]** key to choose menu 05 and display " **SIGNAL** ".
3. Press **[A/FUNC]** key enter into next menu, LCD displays " **➡** " icon, press **[B▲]** / **[C▼]** to select desired setting.

**SQ:** Hear all communications regardless of the signaling tones.

**CT/DCS:** Hear only the signals with matching CTCSS or DCS tones.

**Tone:** Hear only the signals with matching DTMF tones, (Self ID). Refer to P.42 to set the self ID.

**CT&TO:** Hear only the signals with matching CTCSS/DCS, DTMF tones. Selectable when both CTCSS/ DCS and DTMF are enabled.

**CT/TO:** Hear only the signals with matching any one of CTCSS/DCS, DTMF tones. Selectable when both CTCSS/ DCS and DTMF are enabled.

4. Press **[DESC]** key or **[#ENTG]** key to confirm and exit.



## ⦿ Frequency Step

1. After pressing **[A/FUNC]** key, the top corner of LCD displays " **F** " icon, then press **[B/SET]** key.
2. Press **[B▲]** / **[C▼]** key to choose menu 06 and display " **STEP** ".
3. Press **[A/FUNC]** key enter into next menu, LCD displays " **➡** " icon, press **[B▲]** / **[C▼]** to select desired setting.

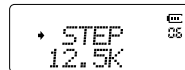

## ○ FUNCTION MENU SETUP

4. Press **[DESCM]** key or **[#ENTRL]** key to confirm and exit.

Available steps are 2.5K, 5K, 6.25K, 10K, 12.5K, 20K, 25K, 30K and 50KHz.

This parameter is not available when the radio is in the Channel mode.

### ((( Wide/ Narrow FM Mode

1. After pressing **[AFUNC]** key, the top corner of LCD displays "**F**" icon, then press **[BSET]** key.
2. Press **[B▲]** / **[C▼]** key to choose menu 07 and display "**W/N**".
3. Press **[AFUNC]** key enter into next menu, LCD displays "**➡**" icon, press **[B▲]** / **[C▼]** to select desired setting.

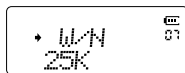

Available parameters are 12.5(narrow) and 25KHz(wide).

4. Press **[DESCM]** key or **[#ENTRL]** key to confirm and exit.

### ((( Frequency Reverse

This function temporary reverses the transmitting and receiving frequencies and signaling tone settings.

1. After pressing **[AFUNC]** key, the top corner of LCD displays "**F**" icon, then press **[BSET]** key.
2. Press **[B▲]** / **[C▼]** key to choose menu 08 and display "**REV**".
3. Press **[AFUNC]** key enter into next menu, LCD displays "**➡**" icon, press **[B▲]** / **[C▼]** to select desired setting.

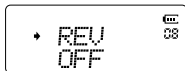

**ON:** enable frequency reverse.

**OFF:** disable frequency reverse.

- Press **[DESCM]** key or **[#ENTRL]** key to confirm and exit.  
This function is not available when Talk Around function is activated.

### Talk Around

- After pressing **[AFUNC]** key, the top corner of LCD displays "**E**" icon, then press **[BSET]** key.
- Press **[B▲]** / **[C▼]** key to choose menu 09 and display "**TAL KAR**".
- Press **[AFUNC]** key enter into next menu, LCD displays "➡" icon, press **[B▲]** / **[C▼]** to select desired setting.  
**TX=RX:** talk around enables  
**OFF:** talk around disables
- Press **[DESCM]** key or **[#ENTRL]** key to confirm and exit.

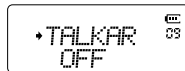

### Offset Frequency

- After pressing **[AFUNC]** key, the top corner of LCD displays "**E**" icon, then press **[BSET]** key.
- Press **[B▲]** / **[C▼]** key to choose menu 10 and display "**OFF SET**".
- Press **[AFUNC]** key enter into next menu, LCD displays "➡" icon, press **[B▲]** / **[C▼]** to select desired setting.  
Available parameters are 0.00 to 80.00 MHz in step size selected in menu 06.
- Press **[DESCM]** key or **[#ENTRL]** key to confirm and exit.

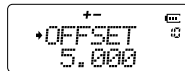

**NOTE: Frequency offset of main band and subband are separated setting.**

## ○ FUNCTION MENU SETUP

### ⦿ Editing Channel name

1. After pressing **[A<sub>FUNC</sub>]** key, the top corner of LCD displays " **F** " icon, then press **[B<sub>SET</sub>]** key.
2. Press **[B<sub>▲</sub>]** / **[C<sub>▼</sub>]** key to choose menu 11 and display "NAME".
3. Press **[A<sub>FUNC</sub>]** enter into next menu, LCD displays " **➡** " icon, press **[B<sub>▲</sub>]** / **[C<sub>▼</sub>]** to choose desired character, press **[1<sub>FM</sub>]** key to confirm current character and move shift to next character. Press **[4<sub>+/-</sub>]** key back to the previous character.
4. Press **[DESCM]** key or **[#ENTNG]** key to confirm and exit.

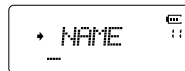

### ⦿ Busy Channel Lockout

This function prohibits the transmitting when the channel is busy.

1. After pressing **[A<sub>FUNC</sub>]** key, the top corner of LCD displays " **F** " icon, then press **[B<sub>SET</sub>]** key.
2. Press **[B<sub>▲</sub>]** / **[C<sub>▼</sub>]** key to choose menu 12 and display "RPLOCK".
3. Press **[A<sub>FUNC</sub>]** key enter into next menu, LCD displays " **➡** " icon, press **[B<sub>▲</sub>]** / **[C<sub>▼</sub>]** to select desired setting.



**REPEAT:** Signaling busy lock. It suspends transmitting when receives a matching carrier but incorrect signaling tones.

**BUSY:** Carrier busy lock. It suspends transmitting when receives any carrier signal.

**OFF:** PTT operation is always possible without busy channel lockout.



- Press **DESCM** key or **#ENTNL** key to confirm and exit.

### Prohibits transmitting

- After pressing **AFUNC** key, the top corner of LCD displays " **F** " icon, then press **BSET** key.
- Press **B▲** / **C▼** key to choose menu 13 and display "TX".
- Press **AFUNC** key enter into next menu, LCD displays " **▶** " icon, press **B▲** / **C▼** to select desired setting.

**ON:**Transmitting is allowed.

**OFF:**Transmitting disabled.

- Press **DESCM** key or **#ENTNL** key to confirm and exit.

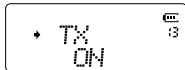

### Scrambler Setup (Encryption)

An analog voice inversion scrambler can be equipped as optionals. This special audio process can offer a more confidential communication. Other radios at same frequency will receive only disordered noises.

- After pressing **AFUNC** key, the top corner of LCD displays " **F** " icon, then press **BSET** key.
  - Press **B▲** / **C▼** key to choose menu 14 and display "SCR".
  - Press **AFUNC** key enter into next menu, LCD displays " **▶** " icon, press **B▲** / **C▼** to select desired setting.
- 1~11 + EDIT:** 11 fixed scrambles and 1 edit scramble (Edit code by PC software).

**OFF:** Scrambler Setup disabled.

- Press **DESCM** key or **#ENTNL** key to confirm and exit.

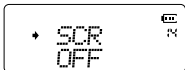

## ○ FUNCTION MENU SETUP

### ((( Voice Comander

This function works only when all users enable Voice-comander. If not, it worse the audio quality. Enable this function to reduce background noise and enhance audio clarity, especially in long range communication.

1. After pressing (A/FUNC) key, the top corner of LCD displays " **F** " icon, then press (B/SET) key.
2. Press (B/▲) / (C/▼) key to choose menu 15 and display "**COMP**".
3. Press (A/FUNC) key enter into next menu, LCD displays " ➡ " icon, press (B/▲) / (C/▼) to select desired setting.  
**ON:** Voice Comander is allowed.  
**OFF:** Voice Comander is disabled.
4. Press (DESCW) key or (#/ENTL) key to confirm and exit.

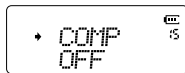

### ((( Band Limit

When this function is on, inputting frequency or Scanning frequency under VFO is limited in current VFO frequency band.

1. After pressing (A/FUNC) key, the top corner of LCD displays " **F** " icon, then press (B/SET) key.
2. Press (B/▲) / (C/▼) key to choose menu 16 and display "**BAND**".
3. Press (A/FUNC) key enter into next menu, LCD displays " ➡ " icon, press (B/▲) / (C/▼) to select desired setting.  
**OFF:** Band limit is disabled.
4. Press (DESCW) key or (#/ENTL) key to confirm and exit.

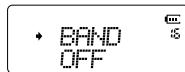

### Sub Band Display

1. After pressing **(A)FUNC** key, the top corner of LCD displays "**F**" icon, then press **(B)SET** key.
2. Press **(B)▲** / **(C)▼** key to choose menu 17 and display "**DSP SUB**".
3. Press **(A)FUNC** key enter into next menu, LCD displays "▶" icon, press **(B)▲** / **(C)▼** to select desired setting.

**FREQ:** Display sub band frequency or channel.

**VOLT:** Display current battery voltage.

**RADIO:** Display FM radio frequency.

**OFF:** Sub band display is disabled and it will unable to receive signal.

4. Press **(DESC)M** key or **(#)ENTNL** key to confirm and exit.

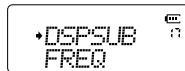

### Beep Sounds

1. After pressing **(A)FUNC** key, the top corner of LCD displays "**F**" icon, then press **(B)SET** key.
2. Press **(B)▲** / **(C)▼** key to choose menu 18 and display "**BEEP**".
3. Press **(A)FUNC** key enter into next menu, LCD displays "▶" icon, press **(B)▲** / **(C)▼** to select desired setting.

**ON:** Beep sounds is enabled.

**OFF:** Beep sounds is disabled.

4. Press **(DESC)M** key or **(#)ENTNL** key to confirm and exit.



## ○ FUNCTION MENU SETUP

### ((( Time-Out-Timer (TOT)

The purpose of Time-out-Timer is to restrict transceiver for continuous long-term transmission. When the continuous transmission time is beyond the preset time, transceiver is forced to stop transmitting and make a beep sound.

1. After pressing (A/FUNC) key, the corner of LCD displays "F" icon, then press (B/SET) key.
2. Press (B/▲) / (C/▼) key to choose menu 19 and display "TOT".
3. Press (A/FUNC) key enter into next menu, LCD displays "➡" icon, press (B/▲) / (C/▼) to select desired setting.

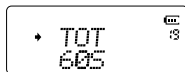

OFF, 10~270s of TOT for optional, each interval is 10 seconds.

4. Press (D/DESC/M) key or (#/ENT/CLK) key to confirm and exit.

### ((( Voice Operated Transmission (VOX)/(An optional earphone-microphone is necessary)

When this function is on, the transmitting can be started by voice, no need to press [PTT] key.

1. After pressing (A/FUNC) key, the top corner of LCD displays "F" icon, then press (B/SET) key.
2. Press (B/▲) / (C/▼) key to choose menu 20 and display "VOX".
3. Press (A/FUNC) key enter into next menu, LCD displays "➡" icon, press (B/▲) / (C/▼) to select desired setting.

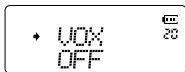

**1~10** : Total 10 VOX levels for optional.

**OFF**: VOX function is disabled.

## ○ FUNCTION MENU SETUP

**ALINCO**

1 is most sensitive, 10 is less sensitive that requires more voice level to activate VOX.

4. Press **[DESCM]** key or **[#ENTRL]** key to confirm and exit.

**NOTE: VOX is not usable in noisy areas as it may start transmitting by the back noise.**

### ((( Voice Operated Transmission (VOX) Delay Time

If transceiver returns to receive mode instantly after VOX calling, it may cause calling voice missing. To avoid this problem, user can set a suitable delay time.

1. After pressing **[AFUNC]** key, the top corner of LCD displays "**F**" icon, then press **[BSET]** key.
2. Press **[B▲]** / **[C▼]** key to choose menu 21 and display "**VDELAY**".
3. Press **[AFUNC]** key enter into next menu, LCD displays "**▶**" icon, press **[B▲]** / **[C▼]** to select desired setting.

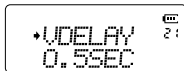

**0.5S-3S:** Total 27 levels for optional, each interval is 0.1S

4. Press **[DESCM]** key or **[#ENTRL]** key to confirm and exit.

### ((( Automatic Power Off Time

When this function is on, transceiver will automatic power off when reach the preset time.

1. After pressing **[AFUNC]** key, the top corner of LCD displays "**F**" icon, then press **[BSET]** key.
2. Press **[B▲]** / **[C▼]** key to choose menu 22 and display "**APO**".
3. Press **[AFUNC]** key enter into next menu, LCD displays "**▶**" icon, press **[B▲]** / **[C▼]** to select desired setting.

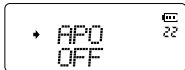

**30MIN:** Automatic Power-Off after 30 minutes.

## ◦ FUNCTION MENU SETUP

**1HOUR:** Automatic Power-Off after one hour.

**2HOUR:** Automatic Power-Off after two hours.

4. Press **[DESCM]** key or **[#ENTKL]** key to confirm and exit.

### ((( DTMF Transmitting Time

1. After pressing **[AFUNC]** key, the top corner of LCD displays "**F**" icon, then press **[BSET]** key.
2. Press **[B▲]** / **[C▼]** key to choose menu 23 and display "**DTMF**".
3. Press **[AFUNC]** key enter into next menu, LCD displays "**▶**" icon, press **[B▲]** / **[C▼]** to select desired setting.

**50MS:** Each DTMF signal transmits 50ms, interval 50ms

**100MS:** Each DTMF signal transmits 100ms, interval 100ms

**200MS:** Each DTMF signal transmits 200ms, interval 200ms

**300MS:** Each DTMF signal transmits 300ms, interval 300ms

**500MS:** Each DTMF signal transmits 500ms, interval 500ms

4. Press **[DESCM]** key or **[#ENTKL]** key to confirm and exit.

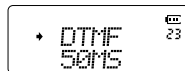

### ((( Squelch Level

This function is used for setup intensity of receiving signals, transceiver will hear calls when receiving signal intensity achieve preset data, otherwise, transceiver will keep mute.

1. After pressing **[AFUNC]** key, the top corner of LCD displays "**F**" icon, then press **[BSET]** key.
2. Press **[B▲]** / **[C▼]** key to choose menu 24 and display "**SQL**".
3. Press **[AFUNC]** key enter into next menu, LCD displays "**▶**" icon, press **[B▲]** / **[C▼]** to select desired setting.

## ○ FUNCTION MENU SETUP

**ALINCO**

**00~09:** 10 levels of squelch in total for optional, "00" is minimum setup value (normally open)

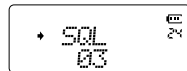

4. Press **DESCM** key or **#ENTNL** key to confirm and exit.

### ((( Scan Dwell Time

There are three kinds of scan dwell time for optional.

1. After pressing **AFUNC** key, the top corner of LCD displays "**F**" icon, then press **BSET** key .
2. Press **B▲** / **C▼** key to choose menu 25 and display "**SCAN**".
3. Press **AFUNC** key enter into next menu, LCD displays "**►**" icon, press **B▲** / **C▼** to select desired setting.

**5ST:** When scanning matched signal, transceiver will stop scanning for 5seconds then resume.

**10ST:** When scanning matched signal, transceiver will stop scanning for 10seconds then resume.

**15ST:** When scanning matched signal, transceiver will stop scanning for 15seconds then resume.

**2SP:** When scanning matched signal, transceiver will stop scanning, 2seconds after signal disappeared, then resume.

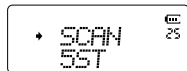

4. Press **DESCM** key or **#ENTNL** key to confirm and exit.

### ((( Function Icon Stay Time

This function allows the user to choose how to display Icon "**F**" in the desired way.

1. After pressing **AFUNC** key, the top corner of LCD displays "**F**" icon, then press **BSET** key.
2. Press **B▲** / **C▼** key to choose menu 26 and display "**FTIME**".

## ○ FUNCTION MENU SETUP

3. Press **A**FUNC key enter into next menu, LCD displays "➡" icon, press **B**▲ / **C**▼ to select desired setting.

**FUNCT:** When finished function setting or enter into function menu, "F" icon will disappear.

**1SEC:** When finished function setting or enter into function menu, "F" icon stay 1second then disappeared.

**2SEC:** When finished function setting or enter into function menu, "F" icon stay 2seconds then disappeared.

**3SEC:** When finished function setting or enter into function menu, "F" icon stay 3seconds then disappeared.

**ALWAYS:** Function icon always displays, only when press "A"FUNC " key again, the "F" icon will disappear.



4. Press **D**DESCM key or **#**ENTRL key to confirm and exit.

**NOTE: When function icon is staying, user can setup desired functions continuously, no need press function key every time.**

## ((( LCD Backlight

1. After pressing **A**FUNC key, the top corner of LCD displays "F" icon, then press **S**SET key.

2. Press **B**▲ / **C**▼ key to choose menu 27 and display "LIGHT".

3. Press **A**FUNC key enter into next menu, LCD displays "➡" icon, press **B**▲ / **C**▼ to select desired setting.

**AUTO:** Backlight will automatic closed after a period.

**OFF:** Always off.

**ON:** Always on.

4. Press **D**DESCM key or **#**ENTRL key to confirm and exit.

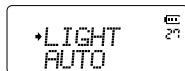



### Ⓜ LCD Backlight Color

There are three kinds of backlight color for optional.

1. After pressing (A FUNC) key, the top corner of LCD displays " F " icon, then press (B SET) key.
2. Press (B ▲) / (C ▼) key to choose menu 28 and display "COLOR".
3. Press (A FUNC) key enter into next menu, LCD displays " ➡ " icon, press (B ▲) / (C ▼) to select desired setting.

**ORG:** Orange backlight

**PUR:** Purple backlight

**BLUE:** Blue backlight

4. Press (DESCM) key or (#ENTNL) key to confirm and exit.

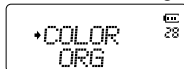

### Ⓜ Self ID Inquiry

This function is self ID code of transceiver. When communicate to others, which using the DTMF function you need to know receivers self ID code and you may store their self ID code as DTMF code in your DTMF code list (refer to P.19).

1. After pressing (A FUNC) key, the top corner of LCD displays " F " icon, then press (B SET) key.

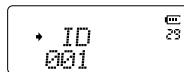

2. Press (B ▲) / (C ▼) key to choose menu 29 and display "ID".

The ID code displaying on LCD is transceiver self ID code. Set self ID code by PC software.

3. Press (DESCM) key or (#ENTNL) key to confirm and exit.

## ○ FUNCTION MENU SETUP

### ((( Tone Burst Frequency

This function is used for waking up sleeping repeater, it needs a certain intensity of Tone Burst to wake up sleeping repeater. In general, as long as the repeater has been waked up, no need to transmit Tone Pulse again in preset time.

1. After pressing (A FUNC) key, the top corner of LCD displays " **F** " icon, then press (B SET) key.

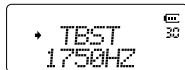

2. Press (B ▲) / (C ▼) key to choose menu 30 and display "TBST".
3. Press (A FUNC) key enter into next menu, LCD displays " ➡ " icon, press (B ▲) / (C ▼) to select desired setting.  
1750Hz, 2100Hz, 1000Hz, 1450Hz, OFF, 4 kinds of Tone Burst for optional
4. Press (DESCM) key or (#ENTNL) key to confirm and exit.

### ((( Battery Save

User can setup battery save ratio according to requirements. The standby time can be extended when enable battery save function, but if save ratio setting too high, it may cause voice missing.

1. After pressing (A FUNC) key, the top corner of LCD displays " **F** " icon, then press (B SET) key.
2. Press (B ▲) / (C ▼) key to choose menu 31 and display "SAVE".
3. Press (A FUNC) key enter into next menu, LCD displays " ➡ " icon, press (B ▲) / (C ▼) to select desired setting.

**OFF:** Battery Save is disabled.

## ○ FUNCTION MENU SETUP

**ALINCO**

**1:2** The standby time between normal working state and battery saving mode is 1:2

**1:3** The standby time between normal working state and battery saving mode is 1:3

**1:5** The standby time between normal working state and battery saving mode is 1:5

**1:8** The standby time between normal working state and battery saving mode is 1:8

**AUTO:** Battery save ratio is adjusting automatically.

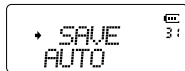

4. Press **DESCM** key or **#ENTRL** key to confirm and exit.

**NOTE: The Battery Save function is temporarily suspended when a key is operated or a signal is received.**

**Remind:** When single band UHF or VHF in standby, proposed setup is 1:8, when dual band VV,UU or UV in standby, proposed setup is 1:2.

## FM Radio

1. After pressing **AFUNC** key, the top corner of LCD displays "**F**" icon, then press **BSET** key.

2. Press **B▲** / **C▼** key to choose menu 32 and display "**RADIO**".

3. Press **AFUNC** key enter into next menu, LCD displays "▶" icon, press **B▲** / **C▼** to select desired setting.

**ON:** FM radio function is enable.

**OFF:** FM radio function is disable.

4. Press **DESCM** key or **#ENTRL** key to confirm and exit.



**NOTE: Only when this function is setting ON, FM radio can be normally used.**

## ○ FUNCTION MENU SETUP

### ((( PF1 and PF2 Key Function

1. After pressing **[A FUNC]** key, the top corner of LCD displays "**F**" icon, then press **[B SET]** key to enter function menu.
2. Press **[B ▲]** / **[C ▼]** key to choose menu 33 "**PF1**" or menu 34 "**PF2**".
3. Press **[A FUNC]** key enter into next menu, LCD displays "➡" icon, press **[B ▲]** / **[C ▼]** to select desired setting.

**VOLT:** Displays current battery capacity.

**CALL:** Call function.

**ALARM:** Emergency alarm function.

**OFF:** No function.

4. Press **[DESCIM]** key or **[#ENTNL]** key to confirm and exit.

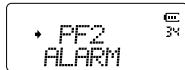
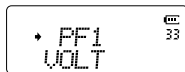

### ((( Display Mode Setup

There are three kinds of display modes for optional.

1. Press **[MONI]** key to turn on radio, hold **[MONI]** key until transceiver emits beep.
2. Press **[B ▲]** / **[C ▼]** key to choose No. 01 function item, it shows "**DSP**" on LCD.
3. Press **[A FUNC]** key enter into next menu, LCD displays "➡" icon, press **[B ▲]** / **[C ▼]** to select desired setting.

**FREQ:** Transceiver displays current channel number + frequency, press **[DESCIM]** key to switch into VFO mode.

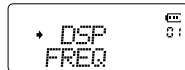

**CH:** Channel mode, 1~23 items of function menu will be hidden automatically, user can only operate

some functions. It is unable to switch into VFO by pressing **[DESCM]** key and the factory default setting is locked. This mode can be used for professional mode. User can select lock channel mode or unlock channel mode by setting in PC software.

**NAME:** Transceiver displays current channel number + channel name, press **[DESCM]** key to switch into VFO mode.

4. Press **[DESCM]** key or **[#ENTNL]** key to confirm and exit.setup.

### ((( Resume Factory Default

You can make all the settings of transceiver return to the factory default settings when transceiver can not work normally because of wrong operation or error setup.

1. Press [MONI] key to turn on radio, hold [MONI] key until transceiver emits beep.
2. Press **[B▲]** / **[C▼]** key to choose No. 02 function item, it shows "**RESTOR**" on LCD. (No. 03 shows "**SOFT**" to check the firmware version of transceiver).
3. Press **[AFUNC]** key enter into next menu, LCD displays "➡" icon, press **[B▲]** / **[C▼]** to select desired setting.

**OFF:** No operations.

**FACT:** Resume all items to factory default, including channel and background settings.

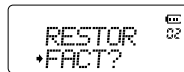

**INIT:** Resume background settings to factory default, channel operations are keeping.

4. Press **[#ENTNL]** key to confirm current selection or **[DESCM]** to cancel the operation and exit.

## ◦ AUXILIARY FUNCTIONS

For dealers only. Please contact the authorized importer of your area for more details.

### (((Cable Cloning

With this function, you can copy the programming data of the transceiver to another one; it can copy parameters and memory programming data to another transceiver.

Connection: use wire cloning cable of your own to connect main transceiver with sub-transceiver through reading / writing programmable interface.

Setup: Shutdown state

1. Hold **4+/-** side key to power on, LCD displays "**CLONE**", main transceiver enters into CLONE mode.
2. Press [PTT] key , LCD displays "**CLONE XX**", XX means the transmitted data quantity.
3. After data copies completely, LCD displays "**CLONE**".
4. Main transceiver stays in this mode preparing to next copy, restart main transceiver to exit CLONE mode.

Setup: sub-transceiver party.

1. When receiving data, LCD displays "**CLONE XX** ", XX means the received data quantity.
2. After data received sub-transceiver returns to normal mode.
3. Power off, take over cable line and link to another sub-transceiver which you want to copy. If data can not transfer successfully, power off main transceiver and sub-transceiver, check the cable line and repeat the process.

🔊 **Cable Cloning Instruction**

Connect the cable to SP jack

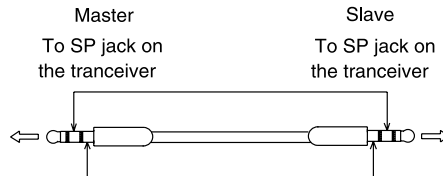
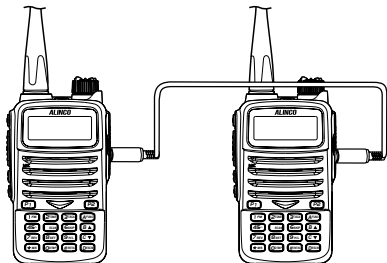

**NOTE:** Commonly available 3.5mm  $\phi$  stereo miniplug audio cable is usable.

## ○ OPTIONAL ACCESSORIES

<b>EA-277</b>	<b>VHF/UHF Antenna</b>
<b>EBC-41</b>	<b>Belt Clip</b>
<b>EA-107</b>	<b>Li-ion Battery Pack (DC 7.4V 1800mAh)</b>
<b>EDC-314</b>	<b>Li-ion Battery Charger</b>
<b>EDC-191E</b>	<b>AC Adaptor (220V)</b>
<b>EME-56A</b>	<b>Earphone Microphone</b>
<b>EMS-76</b>	<b>Speaker microphone</b>



## ◦ RECOMMENDED INSTALLATION OF EARPHONE MICROPHONE

**ALINCO**

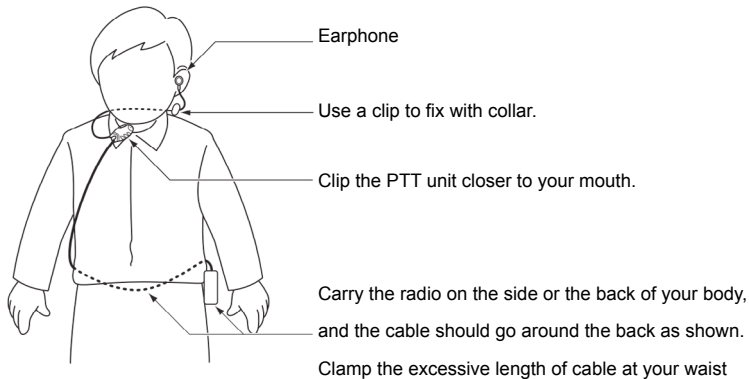

## TECHNICAL SPECIFICATION

General	
Frequency Range	VHF: 136~174MHz UHF: 400~480MHz FM: 76~108MHz (RX only)
Channel Capacity	200 channels
Channel Spacing	25KHz (wide band) 12.5KHz (narrow band)
Phase-locked Step	2.5KHz/6.25KHz
Operation Voltage	7.4V DC $\pm$ 20%
Battery Life	More than 12 Hours(1800mAh), by 5-5-90 working cycle
Frequency Stability	$\pm$ 2.5ppm
Operation Temperature	-20°C ~ +55°C
Size	92x57x35 mm (with battery pack)
Weight	approx. 213g (with battery pack)

Receiving Part		
	Wide band	Narrow band
Sensitivity (12dB SINAD)	$\leq$ 0.25 $\mu$ V	$\leq$ 0.35 $\mu$ V
Adjacent Channel Selectivity	$\geq$ 65dB	$\geq$ 60dB
Intermodulation	$\geq$ 60dB	$\geq$ 60dB
Spurious Rejection	$\geq$ 70dB	$\geq$ 70dB
Hum & Noise	$\geq$ 45dB	$\geq$ 40dB
Audio Distortion	$\leq$ 5%	
Audio Power Output	1000mW/10%	

Transmitting Part		
	Wide band	Narrow band
Power Output	4W/2W/1W (UHF) 5W/2W/1W (VHF)	
Modulation	16K $\Phi$ F3E	11K $\Phi$ F3E
Adjacent Channel Power	$\geq$ 65dB	$\geq$ 60dB
Hum & Noise	$\geq$ 40dB	$\geq$ 40dB
Spurious Emission	$\geq$ 60dB	
Audio Distortion	$\leq$ 5%	

Problem	Corrective Action
No power	A.The battery may be exhausting. Recharge or replace the battery. B.The battery may not be installed correctly. Remove the battery and install it again.
Battery power dies shortly after charging.	The battery life is finished. Replace the battery pack with a new one.
No sound after using earphone. for a while	Earphone jack is broken. Please contact with local dealers to repair.
Cannot talk or hear other members in your group	A.Different frequency or channel, please change it. B.Different CTCSS / DCS / DTMF, please reset it. C.Out of communication range.
Receiving intermittent with in big noise	Out of communication range or obstruct by tall buildings or in big noise.
Displaying strange characters	Turn off transceiver then turn on to restart.

## ◦ ATTACHED CHART

### ((( CTCSS Frequency Chart

1	62.5	12	94.8	23	136.5	34	177.3	45	218.1
2	67.0	13	97.4	24	141.3	35	179.9	46	225.7
3	69.3	14	100.0	25	146.2	36	183.5	47	229.1
4	71.9	15	103.5	26	151.4	37	186.2	48	233.6
5	74.4	16	107.2	27	156.7	38	189.9	49	241.8
6	77.0	17	110.9	28	159.8	39	192.8	50	250.3
7	79.7	18	114.8	29	162.2	40	196.6	51	254.1
8	82.5	19	118.8	30	165.5	41	199.5	52	user-defined
9	85.4	20	123.0	31	167.9	42	203.5		
10	88.5	21	127.3	32	171.3	43	206.5		
11	91.5	22	131.8	33	173.8	44	210.7		

📡 **1024 Groups DCS Frequency Chart**

000	001	002	003	004	005	006	007
010	011	012	013	014	015	016	017
020	021	022	023	024	025	026	027
030	031	032	033	034	035	036	037
040	041	042	043	044	045	046	047
050	051	052	053	054	055	056	057
060	061	062	063	064	065	066	067
070	071	072	073	074	075	076	077
100	101	102	103	104	105	106	107
110	111	112	113	114	115	116	117
120	121	122	123	124	125	126	127
130	131	132	133	134	135	136	137
140	141	142	143	144	145	146	147
150	151	152	153	154	155	156	157
160	161	162	163	164	165	166	167
170	171	172	173	174	175	176	177
200	201	202	203	204	205	206	207
210	211	212	213	214	215	216	217
220	221	222	223	224	225	226	227
230	231	232	233	234	235	236	237
240	241	242	243	244	245	246	247

250	251	252	253	254	255	256	257
260	261	262	263	264	265	266	267
270	271	272	273	274	275	276	277
300	301	302	303	304	305	306	307
310	311	312	313	314	315	316	317
320	321	322	323	324	325	326	327
330	331	332	333	334	335	336	337
340	341	342	343	344	345	346	347
350	351	352	353	354	355	356	357
360	361	362	363	364	365	366	367
370	371	372	373	374	375	376	377
400	401	402	403	404	405	406	407
410	411	412	413	414	415	416	417
420	421	422	423	424	425	426	427
430	431	432	433	434	435	436	437
440	441	442	443	444	445	446	447
450	451	452	453	454	455	456	457
460	461	462	463	464	465	466	467
470	471	472	473	474	475	476	477
500	501	502	503	504	505	506	507
510	511	512	513	514	515	516	517

## ◦ ATTACHED CHART

520	521	522	523	524	525	526	527
530	531	532	533	534	535	536	537
540	541	542	543	544	545	546	547
550	551	552	553	554	555	556	557
560	561	562	563	564	565	566	567
570	571	572	573	574	575	576	577
600	601	602	603	604	605	606	607
610	611	612	613	614	615	616	617
620	621	622	623	624	625	626	627
630	631	632	633	634	635	636	637
640	641	642	643	644	645	646	647
650	651	652	653	654	655	656	657
660	661	662	663	664	665	666	667
670	671	672	673	674	675	676	677
700	701	702	703	704	705	706	707
710	711	712	713	714	715	716	717
720	721	722	723	724	725	726	727
730	731	732	733	734	735	736	737
740	741	742	743	744	745	746	747
750	751	752	753	754	755	756	757
760	761	762	763	764	765	766	767
770	771	772	773	774	775	776	777