VHF/UHF FM TWIN BAND HANDHELD TRANSCEIVER

DJ-580T/E

INSTRUCTION MANUAL

ALINCO ELECTRONICS INC.

438 Amapola Avenue, Unit 130, Torrance, CA 90501, U.S.A.
Phone:(310)618-8616

1-1-1 Mishimae, Takatsuki city, Osaka 569, Japan

TABLE OF CONTENTS

1. INTRODUCTION	4	8-4-3 CALL/MEMORY DUAL WATCH	27
1-1 STANDARD ACCESSORIES	4	9. SCANNING FUNCTIONS	28
1-2 OPTIONAL ACCESSORIES	4	9-1 VFO SCAN	28
2. SPECIFICATIONS	5	9-1-1 PROGRAM BAND SCAN MODE (VFO MODE)	28
2-1 GENERAL SPECIFICATIONS	5	9-2 MEMORY SCAN MODE	28
2-2 U.S. FREQUENCY COVERAGE	5	9-2-1 MEMORY CHANNEL SKIP MODE	29
2-3 EUROPEAN FREQUENCY COVERAGE	5	9-3 SCANNING TYPES	29
2-4 TRANSMITTER SPECIFICATIONS	5	9-4 OTHER SCANNING INFORMATION	29
2-5 RECEIVER SPECIFICATIONS	6	9-4-1 DUAL BAND SCAN	29
3. QUICK REFERENCE	7	9-4-2 DUAL BAND SCANNING WITH MEMORY PRIORITY	29
3-1 RECEIVE	7	10. REPEATER OPERATIONS	30
3-2 TRANSMIT	7	10-1 SPLIT FREQUENCY FUNCTION	30
3-3 PROGRAMMING	7	10-1-1 VFO MODE SPLIT	30
3-4 SCANNING	7	10-1-2 MEMORY MODE SPLIT	30
3-5 PRIORITY	8	10-2 REV KEY	30
3-6 AUTOPATCH	8	10-3 RESETTING RADIO	30
3-7 DSQ SCHEME	8	10-4 CTCSS ENCODE/DECODE	30
3-8 CROSSBAND REPEATER	9	11. AUTOPATCH OPERATION (AUTOMATIC DIALER)	32
4. DESCRIPTIONS	10	11-1 PROGRAM AUTODIAL NUMBER	32
4-1 FRONT PANEL CONTROLS/FUNCTIONS	10	11-2 CLEAR DIALER MEMORY	32
4-2 TOP PANEL CONTROLS/FUNCTIONS	16	11-3 CORRECTING CODES IN DIALER MEMORY	32
4-3 LEFT SIDE CONTROLS/FUNCTIONS	17	11-4 TRANSMIT AUTODIAL NUMBER	32
4-4 RIGHT SIDE CONTROLS/FUNCTIONS	18	11-5 MANUAL DIAL	32
4-5 LCD DISPLAY DESCRIPTIONS	18	11-6 DISABLE AUTODIAL	33
5. GETTING STARTED (RECEIVING)	20	12. DIGITAL SQUELCH (DSQ)	34
5-1 KEY PAD DIRECT ENTRY	20	12-1 DSQ SCHEME	34
5-2 STEP KEY	21	12-2 PROGRAMMING ALL DSQ CODES	34
5-3 KEYPAD ENTRY	21	12-3 DSQ MODES	35
5-4 CLEARING ENTRY	21	12-3-1 TRANSMITTING (CODE SQUELCH)	35
5-5 MONO BAND FUNCTION	21	12-3-2 RECEIVING (CODE SQUELCH)	35
6. TRANSMITTING	22	12-3-3 TRANSMITTING (GROUP CALLING)	36
6-1 POWER OUTPUT SETTING	22	12-3-4 RECEIVING (GROUP CALLING)	36
6-2 LOW LEVEL BATTERY MODE	22	12-3-5 TRANSMITTING (PRIVATE CALLING IN A GROUP)	36
7. TRANSCEIVER MODES	23	12-3-6 RECEIVING (PRIVATE CALLING IN A GROUP)	36
7-1 VFO MODE (Variable Frequency Oscillator)	23	12-3-7 TRANSMITTING (PRIVATE CALL)	36
7-2 MEMORY MODE	23	12-3-8 RECEIVING (PRIVATE CALL)	37
7-2-1 PROGRAMMING A MEMORY CHANNEL (MW KEY)	23	12-4 ERROR CODE	37
7-2-2 SCROLL MEMORY	23	12-5 TIMING CONSIDERATIONS	37
7-2-3 CANCELLING A MEMORY CHANNEL	24	12-6 DSQ WILDCARDS	37
7-2-4 FREE VHF/UHF MEMORY CHANNELS	24	12-7 DIGITAL SIGNAL MESSAGE	37
7-2-5 MEMORY TO VFO COPY FUNCTION	24	12-7-1 TRANSMITTING DIGITAL SIGNAL MESSAGE	37
7-3 CALL MODE	24	12-7-2 RECEIVING DIGITAL SIGNAL MESSAGE	38
7-3-1 PROGRAMMING THE CALL CHANNEL (W KEY)	24	12-7-3 TRANSMITTING WITH DIGITAL SIGNAL DISPLAYED	38
7-3-2 ACTIVATING CALL CHANNEL	24	12-7-4 REVIEW DIGITAL SIGNAL MESSAGE MEMORY	38
7-3-3 CALL CHANNEL TO VFO COPY FUNCTION	24	12-7-5 CLEARING MESSAGE MEMORY	38
8. PRIORITY FUNCTIONS	26	13. CROSSBAND REPEATER	39
8-1 VFO PRIORITY	26	13-1 ACTIVATE CROSSBAND REPEATER	39
8-2 MEMORY PRIORITY	26	13-2 DEACTIVATE CROSSBAND REPEATER	39
8-3 CALL PRIORITY	26	14. FULL DUPLEX OPERATION	40
8-4 DUAL WATCH FUNCTION	26	14-1 ENABLE SPEAKER FULL-DUPLEX	40
8-4-1 VFO/MEMORY DUAL WATCH	26	14-2 DISABLE SPEAKER SEMI-DUPLEX	40
8-4-2 CALL/VFO DUAL WATCH	27	15. AIRCRAFT MODIFICATION	41

1. INTRODUCTION

We at Alinco would like to thank you for purchasing the ALINCO DJ-580T (US Model)/DJ-580E (European Model). Radios and other products made by ALINCO rank as some of the finest in the world. Your DJ-580T/E has been manufactured and tested very carefully at the factory and will give you satisfactory operation for many years. We are confident that you will be very satisfied with your choice of this fine ALINCO radio.

1-1 STANDARD ACCESSORIES

When you unpack your ALINCO transceiver, you will find the standard accessories which include:

1. Ni-Cad Battery Pack (7.2V @ 700mAH) **EBP-20N**
2. AC Wall Charger for EBP-20N **EDC-24 (120V) DJ-580T**
EDC-25 (220V/240V) DJ-580E
3. Belt Clip
4. Hand Strap
5. Dual Band Rubber Flex Antenna
6. Schematic Diagram
7. Instruction Manual
8. Warranty registration card

1-2 OPTIONAL ACCESSORIES

To enhance your DJ-580 radio further, optional accessories are available. At ALINCO, we strongly recommend that you purchase appropriate accessories to get full features and performance from your radio.

1. Ni-Cd Battery Pack (7.2V @ 700mAH) **EBP-20N**
2. Ni-Cd Battery Pack (12V @ 700mAH) **EBP-22N**
3. Quick Ni-Cd battery charger **EDC-34 (120V), EDC-35 (220V/240V)**
4. Mobile DC Power Cable/Charger
 with Noise Filter **EDC-36**
 w/o **EDC-43**
5. Earphone **EME-6**
6. DC cable for power supply **EDC-37**
7. Earphone/Earphone **EME-6**
8. Earphone/Microphone with PTT **EME-11**
9. Speaker/Microphone **EMS-2Z**
10. Remote Control Speaker/Microphone **EMS-8Z**
11. Headset with PTT/VOX **EME-10K**
12. Soft Case' **ESC-17**
13. Tone Squelch Unit **EJ-12U**

2. SPECIFICATIONS

The specifications outlined for this product are for use in the amateur bands only. No guarantee or warranty, either specific or implied, will apply to any function or specification outside the amateur bands. Individual radios may experience different performance and/or specification levels. All specifications and features are subject to change without notice or obligation.

2-1 GENERAL SPECIFICATIONS

- Channel Spacing:** 5, 10, 12.5, 15, 20, 25 kHz steps
Memory Channels: 42 Channels (40 total combination of VHF and UHF)
 1 VHF Call Channel
 1 UHF Call Channel
- Antenna Impedance:** 50 Ohms unbalanced
Microphone Input Impedance: 2K Ohms
Signal Type: F3E (FM)
Power Supply Requirements: 13.8 Volts DC
Dimensions (Radio Only): Height = 140mm
 Width = 58mm
 Depth = 33mm
- Weight:** Approximately 410g
DTMF: 16 Button Key Pad
Subaudible Tones: Encode and Decode installed

2-2 U.S. FREQUENCY COVERAGE

The frequency coverage listed as follows applies to the DJ-580T.

- VHF Band:** 144.000 – 147.995 MHz (TX)
 110.000 – 142.995 MHz (RX) * Only after Modification
 130.000 – 173.995 MHz (RX)
- UHF Band:** 440.000 – 449.995 MHz (TX)
 420.000 – 479.995 MHz (RX)

2-3 EUROPEAN FREQUENCY COVERAGE

The frequency coverage listed as follows applies to the DJ-580E.

- VHF Band:** 144.000 – 145.995 MHz (TX/RX)
UHF Band: 430.000 – 439.995 MHz (TX/RX)

2-4 TRANSMITTER SPECIFICATIONS

- Output Power:** Approx. 2 Watts with Standard EBP-20N Battery
 Approx. 5 Watts with Optional EBP-22N Battery
- Modulation System:** Variable reactance FM
Max. Freq. Deviation: +/- 5kHz
Spurious Emission: Less than 60db below carrier

Tone Frequency:	67.0 to 250.3 Hz (38 selections) DJ-580T (Subaudible Encoding Tone) DJ-580E (1,750 Hz Tone Burst)
Microphone:	Electret Condenser
Operating Mode:	
	Simplex:
	Duplex: 5kHz steps minimum between 0-15.995 MHz from receiver frequency.
CTCSS Encoder:	Built-in and included as standard for DJ-580T
CTCSS Decoder:	Built-in and included as standard for DJ-580T

2-5 RECEIVER SPECIFICATIONS

Receiver System:	Superheterodyne, Dual Conversion
Sensitivity:	12dB SINAD less than -15dB per microvolt
Intermediate Frequency:	VHF — 1st IF 55.05 MHz 2nd IF 455 kHz
	UHF — 1st IF 30.875 MHz 2nd IF 455 kHz
Audio Power Output:	250 mW (10% Total Harmonic Distortion)
Speaker Impedance:	8 Ohms

3. QUICK REFERENCE

3-1 RECEIVE

POWER ON

Connect this radio to a DC source of 13.8 volts DC. Rotate power knob clockwise.

VFO MODE

Press the **VHF** or **UHF** key.

VFO FREQUENCY

Use the keypad and enter the frequency. Enter all 6 digits, even if the last digit is zero.

3-2 TRANSMIT

SIMPLEX

FUNC + **SHIFT 1** KEY repeatedly until the display DOESN'T show a "■" or "■" or star symbol.

OFFSET

FUNC + **SHIFT 1** KEY repeatedly until the display indicates either a "■" or "■" symbol.

SPLIT

FUNC + **SHIFT 1** KEY repeatedly until the star symbol is shown on the indicator. Store input frequency into any memory channel. Enter output frequency into VFO.

TONE ENCODE

FUNC + **4** KEY once. Rotate main tuning knob for desired tone. **FUNC** + **5** KEY repeatedly until the "■" indicator displays.

TONE DECODE

FUNC + **4** KEY once. Rotate main tuning knob for desired tone. **FUNC** + **5** KEY repeatedly until the "■ SQL" indicator displays.

3-3 PROGRAMMING

MEMORY MODE

Press the **MEM** KEY.

MEMORY SCROLL

Enter MEMORY MODE, rotate the main tuning knob or use **←** or **→** keys.

MEMORY WRITE

Press **MEM** KEY, rotate main tuning knob and select memory channel, enter frequency, press **FUNC** + **MEM** KEY.

MEMORY SKIP

Enter MEMORY MODE. Rotate the main tuning knob to the channel you desire to skip. Press the **MEM** KEY.

MEMORY TO VFO COPY

Enter VFO MODE, press **MEM** KEY, rotate main tuning knob and select a memory channel, press **FUNC** + **MEM** KEY.

FREE MEMORY CHANNELS

Press **FUNC** + **←** KEY, **FUNC** + **1** KEY. Rotate main tuning knob until the desired memory channels you desire for each band is shown. Press **FUNC** + **←** KEY 4 times until "FL/PL" isn't shown on the display.

CALL CHANNEL

Press the **CALL** KEY.

CALL WRITE

Press the **CALL** KEY, enter frequency, press **FUNC** + **CALL** KEY.

3-4 SCANNING

SCAN VFO

Enter VFO MODE, press the **SCAN** KEY.

SCAN MEMORY

Enter MEMORY MODE, press the **SCAN** KEY.

SCAN DIRECTION

During SCAN rotate the main tuning knob counter clockwise to decrease frequency and clockwise to increase frequency. You may use up or down arrow keys to obtain the same results.

STOP SCAN

Press the **SCAN** KEY.

BUSY SCAN

Stops at a busy channel until clear. This is the radio default. If a black block with a white "■" appears on the LCD display, press

FUNC + **TMS** KEY until it disappears from the display.

TIMED SCAN

Stops at a busy channel and resumes after 5 seconds. Press **FUNC** + **TMS** KEY until a **black block with a white "I"** appears on the LCD display.

DUAL BAND SCAN

Enter VFO frequency, select a memory channel in memory mode, press the **FUNC** + **DUAL** key.

RANGE SCAN

Enter VFO MODE, enter a lower frequency range, press **⊖** KEY, rotate main tuning knob until "P1" appears, press **FUNC** + **⊖** KEY. Rotate the main tuning knob until "P2" appears. Enter the upper frequency range, press **FUNC** + **⊕** KEY. Press **FUNC** + **○** KEY.

3-5 PRIORITY

VFO PRI

VFO received for 4 seconds and MEMORY channel for 1/2 second. Enter VFO MODE, enter frequency, press **⊖** KEY, select memory channel, return to VFO MODE, press the **⊕** KEY.

MEMORY PRI

MEMORY channel received for 5 seconds and VFO for 2 seconds. Enter VFO MODE, enter frequency, press **⊖** KEY, select memory channel, press the **⊕** KEY.

VFO/CALL PRI

VFO is scanned for 1/2 second and CALL channel for 4 seconds. Enter VFO MODE, enter frequency, press **○** KEY, press **⊕** KEY.

MEM/CALL PRI

MEMORY is scanned for 1/2 second and CALL channel for 4 seconds. Enter MEMORY MODE, rotate main tuning knob to selected memory channel, press **○** KEY, press **⊕** KEY.

3-6 AUTOPATCH

PGM AUTODIALER

Press **FUNC** + **⊕** KEY, rotate main tuning knob to either "C1", "C2" or "C3" autodial memory. Enter up to 16 numbers, letters or symbols. Press **FUNC** + **⊕** KEY. Press **PTT** switch to transmit and press **FUNC** key during transmission to transmit autodial sequence.

DISABLE AUTODIALER

Press and hold **FUNC** KEY + **⊕** KEY + **⊖** KEY + **⊕** KEY.

3-7 DSQ SCHEME

DSQ REFERENCE

A-000 = First Group Code
B-000 = Second Group Code
P-000 = Your own Personal Code
y-000 = Other operators own Code
nn-00 = Digital Signal Message

PROGRAM DSQ

1. Enter VFO MODE, press **FUNC** + **⊕** KEY. Enter 3 digits into the first group code A-000..
2. Rotate main tuning knob until "b-000" appears on LCD, enter 3 digits into the second group code B-000.
3. Rotate main tuning knob until "P-000" appears on LCD, enter your unique 3 digit personal code into the P-000 field.
4. Rotate main tuning knob until "y-000" appears on LCD, enter the other operators unique 3 digit code into the Y-000 field.
5. Rotate main tuning knob until "nn-00" appears on LCD, enter a 2 digit code that would be meaningful to the receiving operator.
6. Enter VFO MODE to end DSQ programming.

DSQ CALLING

DSQ CALLING includes DSQ, GROUP CALLING, PRIVATE CALLING IN A GROUP, PRIVATE CALLING.

DSQ CALLING

Press **⊕** KEY repeatedly until "D.SQ" appears on LCD display.

GROUP CALLING

Press **⊕** KEY repeatedly until "G D.SQ" appears on LCD display.

PRIVATE CALLING IN A GROUP

Press **⊕** KEY repeatedly until "G P D.SQ" appears on LCD display.

PRIVATE CALLING

Press **⊕** KEY repeatedly until "P D.SQ" appears on LCD display.

3-8 CROSSBAND REPEATER

ACTIVATE

Set squelch threshold and then advance slightly. Turn volume controls fully counter clockwise. Press **FUNC** + **TMS** KEY. With "FL" indicator on press the following keys: **B**, **S**, **D** and **B**.

DEACTIVATE

Press **FUNC** + **TMS** KEY repeatedly until the "FL / PL" indicators have disappeared from the LCD display.

4. DESCRIPTIONS

This section will discuss what the function or control is and how to use it. The sub-sections are broken down into smaller sections for easy access.

4-1 FRONT PANEL CONTROLS/FUNCTIONS

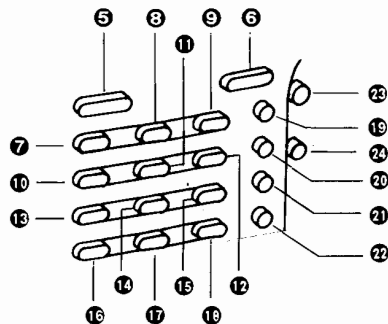
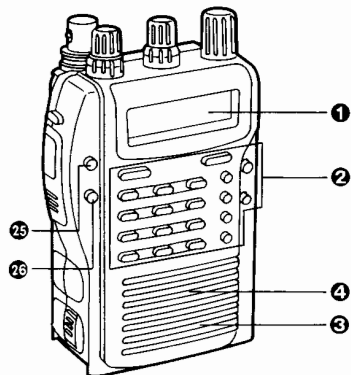

The following descriptions are those functions necessary to utilize full functionality of the DJ-580T/E.

1 LCD DISPLAY PANEL

Refer to Section for further details on the LCD display panel.

2 CONTROL KEYPAD

The control pad includes 16 multi-functional command keys that control and execute various operations for the DJ-580T/E. It also serves as a DTMF keypad.

3 MICROPHONE

An electret condenser microphone is built into the front panel. When transmitting, speak directly into the microphone from a distance of approximately 5 inches. The microphone connectors are labeled as follows:

Smaller Jack (MIC JACK):

Tip: PTT Line/Transmit Audio
Ring: 5V DC (for EME-10K Optional accy)
Sleeve: Signal Ground

Larger Jack (SPEAKER JACK):

Tip: Receive Audio
Ring: Remote Control (for EMS-8 Optional accy)
Sleeve: Signal Ground

4 SPEAKER

The speaker is located below the key pad on the front panel. It's rated at 8 ohms and not in operation when an external speaker is used.

5 VHF BAND KEY

Pressing this key allows for operation on the 2 meter VHF band.

6 UHF BAND KEY

Pressing this key allows for operation on the 70 cm UHF band.

7 SHIFT KEY

The SHIFT KEY is used to change frequency offset and shift.

The symbols "■", "⊕" and "⊗" are used to indicate shifts.

1. Press and hold the **FUNC** key, then press the **SHIFT** key repeatedly until the desired shift appears on the LCD display.

The "■" symbol indicates that the transmitter will subtract the offset with the transmitted frequency.

The "⊕" symbol indicates that the transmitter will add the offset with the transmitted frequency.

The "⊗" symbol indicates a split offset.

Simplex operation is active when neither the "■" or "⊕" or "⊗" symbol is displayed on the LCD display. If "OFF" appears in place of the frequency during transmit, the selected frequency is out-of-band.

2. Select the Main Band by pressing the **VHF** or **UHF** key. The LCD display returns to frequency.

NOTE

For larger incremental frequency changes press the **FUNC** key then rotate the Main Tuning dial. This increments the 1MHz digit.

Amateur radio repeaters utilize separate transmitter and receiver sections. The transmitter frequency may be offset either above or below the receive frequency according to repeater coordination conventions. The standard offset for the 2 meter band is 600 kHz. Offset for the 70cm band is 5 MHz. Offset direction varies according to established band plans.

EXAMPLE: SHIFT

1. Select the Main Band by pressing the **VHF** or **UHF** key.
2. Press and hold the **FUNC** key, then press the **SHIFT** key. An offset will be displayed on the LCD display.
3. Rotate the Main Tuning dial or press either arrow key to select the desired offset. For larger incremental frequency changes, press the **FUNC** key then rotate the Main Tuning dial.
4. Select the Main Band by pressing the **VHF** or **UHF** key or **PTT** key to complete offset procedure.

DJ-580T	DJ-580E
VHF: 600 kHz (0.60)	VHF: 600 kHz (0.60)
UHF: 5 MHz (5.00)	UHF: 7.6 MHz (7.60)

8 STEP KEY

The STEP function is used to select desired incremental changes of receive/transmit frequencies, in steps of 5, 10, 12.5, 15, 20 or 25kHz. **Get more information on "GETTING STARTED" in section.**

1. Select the Main Band by pressing the **VHF** or **UHF** key.
2. Press and hold the **FUNC** key, then press the **STEP** key. The channel step will change each time the **STEP** key is pressed. You

can also change the channel step by using the Main Tuning dial, **▲** or **▼** keys.

3. Select the Main Band by pressing the **VHF** or **UHF** key to set channel step and return to operating frequency.

After channel step is set, the receive/transmit frequency will increase or decrease by the value selected when you turn the Main Tuning dial.

When the transmit frequency extends beyond permissible limits, "OFF" will be displayed on the LCD display. The transmitter will not transmit when "OFF" is displayed.

Refer to the following OFFSET frequency chart (TABLE 1) before you actually transmit. The transmitting frequency may differ from the frequency that appears on the LCD display.

LCD DISPLAY FREQUENCY	ACTUAL FREQUENCY
***.02.5 kHz	***.00.0 kHz
***.07.5 kHz	***.05.0 kHz
***.17.5 kHz	***.15.0 kHz
***.22.5 kHz	***.20.0 kHz
***.27.5 kHz	***.25.0 kHz
***.32.5 kHz	***.30.0 kHz
***.42.5 kHz	***.40.0 kHz
***.47.5 kHz	***.45.0 kHz
***.52.5 kHz	***.50.0 kHz
***.57.5 kHz	***.55.0 kHz
***.67.5 kHz	***.65.0 kHz
***.72.5 kHz	***.70.0 kHz
***.77.5 kHz	***.75.0 kHz
***.82.5 kHz	***.80.0 kHz
***.92.5 kHz	***.90.0 kHz
***.97.5 kHz	***.95.0 kHz

TABLE 1 Offset Frequency Chart

9 REV KEY

In some areas there may be repeaters operating on repeater frequency pairs, the exact reverse of another repeater in the area. That is, the input of one repeater is the output frequency of the other and vice versa. To avoid the inconvenience of reprogramming every time both repeaters are in range, the **REV** key allows instant reversal of the input and output frequencies and the offset direction. The REV function is also useful to check the repeater input to determine if another station is heard directly so you can go simplex. To activate the REV function:

1. Press and hold the **FUNC** key, then press the **REV** key. The repeater input frequency and opposite SHIFT indicator will appear on the LCD display panel.
2. Press and hold the **FUNC** key, then press the **REV** key again to cancel the REV function.
If the frequency, as a result of the **REV** key being activated, is out of band, the beep will sound and no change will take place. The beep won't be heard through the speaker if it has been turned off.

10 TONE KEY

The Tone Encoder and Tone (Decoder) Squelch function is standard on the DJ-580T. Tone Encode and Decode work on the Main Band only. The DJ-580T has 38 settings from 67.0 Hz to 250.3 Hz (TABLE 2). Utilize the **TONE** key to access these settings. Access to an increasing number of repeaters is restricted by requiring that a sub-audible tone be transmitted with the input signal to open the repeater. To select the needed tone, perform the following:

1. Press and hold the **FUNC** key, then press the **TONE** key. A tone frequency will appear in the LCD display.
2. Rotate the Main Tuning dial or either the **B** or ***** key to the desired tone frequency.
3. Select the Main Band by pressing the **VHF** or **UHF** key.
4. The tone has now been selected, now you need to enable it. Press the **B** key.

Refer to section for more information.

67.0	71.9	74.4	77.0	79.7	82.5
85.4	88.5	91.5	94.8	97.4	100.0
103.5	107.2	110.9	114.8	118.8	123.0
127.3	131.8	136.5	141.3	146.2	151.4
156.7	162.2	167.9	173.8	179.9	186.2
192.8	203.5	210.7	218.1	225.7	233.6
241.8	250.3				

TABLE 2 Sub-Audible Tones

11 PO KEY

Change power output levels by performing the following.

1. Press and hold the **FUNC** key, then press the **PO** key repeatedly to obtain the desired output power.
When " H " is displayed it means that the output power is at maximum/high for battery rating. When " M " is displayed it means that the output power is at mid range for battery rating. When " L " is displayed it means that the output power is at the lowest range for battery rating.

WARNING

It is possible to cause UHF receive interference while transmitting on VHF. To avoid this from happening, make sure that the VHF frequency x 3 does not equal the frequency on UHF. For example, if VHF transmit frequency is 146.190MHz the UHF frequency should not be set at 438.570MHz.

12 T.SQL KEY

The Tone Encoder and Tone (Decoder) Squelch function is standard on the DJ-580T. Tone Encode and Decode work on the Main Band only. The DJ-580T has 38 settings from 67.0 Hz to 250.3 Hz (TABLE 3). Utilize the **TONE** key to access these settings. Access to an increasing number of repeaters is restricted by requiring that a sub-audible tone be transmitted with the input signal to open the repeater. To select the needed tone, perform the following:

1. Press and hold the **FUNC** key, then press the **TONE** key. A tone frequency will appear in the LCD display.
2. Rotate the Main Tuning dial or either the **B** or ***** key to the desired tone frequency.
3. Select the Main Band by pressing the **VHF** or **UHF** key.
4. Press and hold the **FUNC** key, then press the **T.SQL** key to display " TSQL " and enable subaudible tone encoding. If " TSQL " and " SQL " display, then tone squelch or tone decoding is enabled.

The tone frequency is now stored and will be transmitted with the repeater input frequency.

67.0	71.9	74.4	77.0	79.7	82.5
85.4	88.5	91.5	94.8	97.4	100.0
103.5	107.2	110.9	114.8	118.8	123.0
127.3	131.8	136.5	141.3	146.2	151.4
156.7	162.2	167.9	173.8	179.9	186.2
192.8	203.5	210.7	218.1	225.7	233.6
241.8	250.3				

TABLE 3 Sub-Audible Tones

13 BEEP KEY

When the BEEP is on, each key pressed will sound a BEEP.

Press and hold the **FUNC** key, then press the **BEEP** key. Each time the BEEP key is pressed the speaker will emit a high or low pitch tone. If the tone is high pitch, the BEEP is disabled, if low it is enabled.

The BEEP function will be set and activated on both bands at the same time. The BEEP will sound only if the BEEP function is on.

The radio comes preset with a low/soft beep audio level. If you would like to increase this level to high, perform the following.

1. Press and hold the **FUNC** key, then press the **BEEP** key. The LCD will display " FL ".
2. Press and hold the **FUNC** key, then press the **STEP** key. The display will indicate " BEEPH ", for beep tone high level audio.
3. Press and hold the **FUNC** key, then press the **STEP** key. The display will indicate " BEEPL ", for beep tone low level audio.
4. Press and hold the **FUNC** key, then press the **FL/PL** key three (3) times to clear " FL / PL " from the display and exit beep tone level mode.

14 TMS/VCS KEY

This key is used to select 1 of 3 scan modes. Refer to section for more information.

15 APO KEY

This **APO** key is used to **Automatically Power Off** the radio. The APO function prevents inadvertent waste of battery power when the radio is left ON unintentionally. Here's how to use it.

1. Press and hold the **FUNC** key, then press the **APO** key. You will see " APO30 " displayed.
2. The time of 30 minutes is preset from the

factory. The time duration can be selected by rotating the Main Tuning Dial. The time is adjustable from 5 to 60 minutes.

3. Press and hold the **FUNC** key, then press the **APO** key. " APO " is displayed on the LCD.

If no activity, a beep is emitted after this time and 30 seconds later the LCD display becomes blank. Battery power has now been removed from the radio. To re-initialize APO, turn the radio off and back on again.

4. Exit the APO function, select the Main Band by pressing the **VHF** or **UHF** key. The " APO " indicator should still be displayed on the LCD.
5. To cancel APO, press and hold the **FUNC** key, then press the **APO** key 2 times. The APO indication should now disappear from the display. Exit the APO function, select the Main Band by pressing the **VHF** or **UHF** key.

Any signal received during the APO time period, APO resets back to the beginning.

16 DOWN ARROW AND FL/PL KEY

The **DOWN** toggles different values depending on what task you are utilizing. It is often used to decrease VFO frequency value. If this key is held down, the value will decrease continuously. " FL " stands for **Frequency Lock**. In this mode the main keypad, **O** and **O** keys are locked and don't function.

" PL " stands for **Push To Talk Lock**. In this mode both bands are locked from the Push to Talk switch. Frequencies can still be entered and stored.

These are useful features to prevent unauthorized functioning while the radio is in unattended monitoring mode. Here's how to use these features.

1. Press and hold the **FUNC** key, then press the **DOWN** key. Each time you press the key, you will toggle the field which will be displayed as follows: " FL ", " PL " then " FL " and " PL " and finally both functions disabled.

17 DUAL KEY

This function is used to monitor two particular channels. The possibilities are:

- VFO and MEMORY channels
- VFO and CALL channels

- VFO and VFO channels
- CALL and MEMORY channels

In other words, dual channel monitoring will listen to two channels. Here's how to make it happen for VFO and MEMORY. You can incorporate the same procedure with the other possibilities of

DUAL WATCH.

1. Select the Main Band by pressing the **VHF** or **UHF** key.
2. Press the **⊖** key. Select the desired memory channel by using the Main Tuning Dial.
The 2 digit memory channel number will blink if it hasn't been programmed. **More on memory channel programming can be found in section .**
3. Return to VFO Mode and enter a VFO frequency.
4. Press and hold the **FUNC** key, then press the **DUAL** key. The "PRI" indicator will now blink on and off on the display. The radio will cycle alternately between VFO frequency and Memory frequency for 1/2 second.
5. When a signal is received, the signal is held for 5 seconds.
6. To release the DUAL/WATCH function, press the **⊕** or chosen VFO key.

18 UP ARROW AND MESS KEY

The **⬆** toggles different values depending on what task you are utilizing. It is often used to increase VFO frequency value. If this key is held down, the value will increase continuously. This **MESS** key is used for Digital Signal messages. **Refer to section .**

19 PRI/DIAL M KEY

"PRI" stands for Priority. When the **⊖** key is pressed the priority function is active. The **⊕** key is used for storing and automatically transmit a sequence of numbers/codes. This would be commonly used for autopatch use. **Refer to section for more information.**

20 GP DSQ/DSQS KEY

This key is used in conjunction with DTMF squelch control. **More information can be found in section .**

21 SKIP/M TO V KEY

The **⊖** key is used to skip selected memory channels during a memory scan.

The **M to V** function of this key is used to copy information from a memory location into the VFO.

22 MR/MW KEY

MR stands for Memory Read. This function is used to examine what information is in a memory channel.

MW stands for Memory Write. This function is used to write/store frequencies and features into a memory channel. Refer to section on for more information.

1. Press the **⊖** key to put the Main Band into Memory Channel mode. A 2 digit memory channel number (0-19) will appear. These 2 digits will flash if nothing has been programmed into the memory channel.
2. Pressing the **⊕** key will increment each programmed memory channel one at a time. Use the Main Tuning Dial to either increment or decrement scanning.

23 SCN/PS KEY

The **⊕** key is used to continually scan frequencies in VFO or memory mode. Press the key down for approximately one second and scan will begin. Scan is active by virtue of the flashing decimal point, just right of the 1 megahertz digit. To cease scan, press the SCN key once again. **PS** stands for **Programmable Scan**. This is used when you want to scan a range of frequencies. You may scan a range of frequencies on VHF and perform the same for UHF at the same time. Here is how it works.

1. Select the Main Band by pressing the **VHF** or **UHF** key.
2. Now enter the lower range frequency via the keypad.
3. Press the **⊖** key. Rotate the Main Tuning Dial and select memory channel "P1".
4. Press and hold the **FUNC** key, then press the **⊕** key. A beep will sound from the speaker and memory channel "P1" will stop blinking. P1 has been successfully programmed with the lower frequency.
5. Now enter the higher range frequency via the keypad.
6. Press the **⊖** key. Rotate the Main Tuning Dial and select memory channel "P2".
7. Press and hold the **FUNC** key, then press

the **⊕** key. A beep will sound from the speaker and memory channel "P2" will stop blinking. P2 has been successfully programmed with the upper frequency.

8. Select the Main VFO band as you did in step 1.
9. Press and hold the **FUNC** key, then press the **⊕** key. The display will show scanning of ranges programmed between P1 and P2. The **P** indicator should begin to blink on the LCD display.
10. Exit programmable scan, select the Main Band by pressing the **VHF** or **UHF** key or **⊕** key.

24 CALL/CALL.W KEY

Each band has 1 Call channel which is immediately accessible by pressing the **⊕** key. An often used frequency of interest such as a preferred local repeater, is usually programmed into the Call channel.

The **⊕** key is used to gain access to the CALL channel.

The **⊕** key is used to write information into the CALL channel.

Refer to section for more information.

25 LAMP KEY

1. Press the **⊕** key to illuminate the LCD display. The lamp goes out automatically after five seconds.
2. If you wish for the lamp to remain on, press and hold the **FUNC** key, then press the **⊕** key.

26 MONI/BS KEY

"MONI" is short for the word **MONITOR** or **SQUELCH OPEN**. Activate this feature as follows:

1. Press and hold the **⊕** key to override the squelch on the band selected. In this mode, weak signals below the squelch threshold may be heard.
"BS" is short for **Battery Saver**. The battery saver feature reduces unnecessary battery drain by alternating between listening and the Battery Saver mode. If there is no operation for a period of 5 seconds the BS mode will listen for a signal for approximately 130 ms then Battery Save for approximately 390 ms. This cycle is repeated continuously. Perform the following to activate or deactivate Battery

Save feature. You can set this function in VHF or UHF or both bands together.

1. To **activate** battery save feature, press and hold the **FUNC** key, then press the **⊕** key until the symbol "S" is displayed.
2. To **deactivate** battery save feature, press and hold the **FUNC** key, then press the **⊕** key until the "S" disappears.

4-2 TOP PANEL CONTROLS/FUNCTIONS

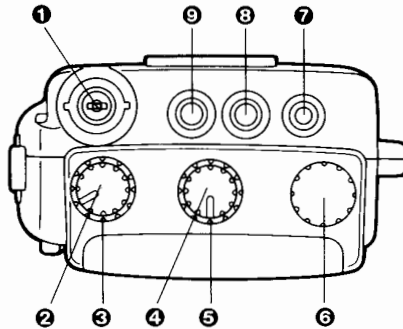

① BNC ANTENNA CONNECTOR

You should attach a suitable Dual-Band antenna that will yield a low SWR. The antenna connected should satisfy both the 2 meter and 70 cm (440MHz) band.

② VHF VOLUME CONTROL

Adjusts the VHF audio level. Rotate control clockwise to increase volume, and counter clockwise to decrease.

③ VHF SQUELCH

Start by turning the knob fully counter clockwise, then rotate the knob back clockwise until background noise is silent.

④ POWER ON/OFF AND UHF VOLUME CONTROL

Power is not applied to the radio when the POWER knob is fully counter clockwise. When the POWER knob is rotated clockwise, power is applied to the radio and volume for the UHF band may be adjusted.

⑤ UHF SQUELCH

Start by turning the knob fully counter clockwise, then rotate the knob back clockwise until background noise is silent.

⑥ MAIN TUNING DIAL

Press the VHF or UHF key to select the Main Band. The Main Tuning dial may be rotated in either direction to select transmit and receive

frequencies, frequency steps, sub-audible tones and transmit frequency offsets. The frequency will increase/decrease by one MHz depending on the direction of the tuning dial rotation.

⑦ MIC JACK

An external microphone may be plugged into this jack.

⑧ SPEAKER JACK

An external speaker rated at 8 ohms may be plugged into this jack. The built-in speaker is disabled when an external speaker is plugged into this jack.

⑨ V/U SPEAKER JACK

The DJ-580T/E features an external stereo speaker jack that makes accessible the audio supplied from each band (UHF/VHF). When a stereo headset is used, each band is heard separately, in each earphone. Separate external speakers may be plugged into this jack by using a mini dual stereo adapter plug. Volume from the VHF band will be heard on the Left channel and UHF will be heard on the Right channel.

CAUTION

Inserting a standard mono plug into this jack will short circuit the UHF channel. USE STEREO PLUGS ONLY!

NOTE

When this jack is in use, the audio jack located on the top of the radio will be disabled.

4-3 LEFT SIDE CONTROLS/FUNCTIONS

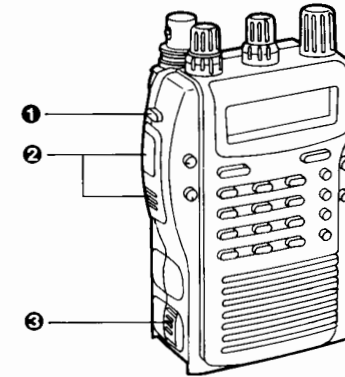

The following controls are located on the left side of the radio as viewed with front panel facing the operator.

① FUNCTION KEY

Controls access to secondary functions. These secondary functions are those functions printed in green on the front panel. It is necessary to activate the Function key to access these secondary functions. While holding the **FUNC** key, press the desired command key.

② PTT SWITCH

Press and hold this button to transmit. While holding the **PTT** SWITCH you may speak into the microphone.

NOTE

On the DJ-580E the lower portion of the **PTT** SWITCH is used to transmit Tone Burst, and the upper portion is the **PTT** SWITCH. On the DJ-580T either button activates **PTT** SWITCH.

③ BATTERY LOCK BUTTON

The battery lock button releases the battery from the radio. The battery is keyed in order to avoid the battery from being inserted incorrectly. To attach the battery, slide battery in guides from left to right until the lock snaps battery into place. To remove battery, push and hold the lock button upwards and slide the battery to the left (from vantage point where radio front panel is facing you).

4-4 RIGHT SIDE CONTROLS/FUNCTIONS

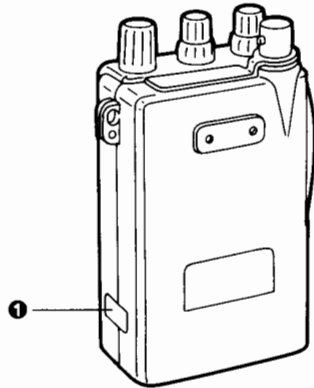

The following controls are located on the right side of the radio as viewed with front panel facing the operator.

1 DC IN JACK

Utilizing this jack will provide maximum output power. Plug an external 13.8V DC power source into this jack.

CAUTION

Observe correct plug polarity. The tip of the connector is (+) and the sleeve is (-). When a voltage source is applied to this jack the battery is cutoff and no charging to the battery will take place.

The EDC-36 or EDC-37 is recommended as optional accessories. Refer to section for additional information on OPTIONAL ACCESSORIES.

4-5 LCD DISPLAY DESCRIPTIONS

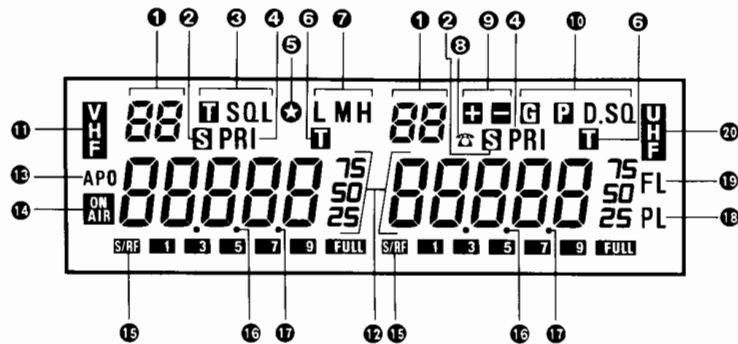

1 MEMORY CHANNEL

This 2 digit indicator shows that the selected band is in memory mode and displays the memory channel number.

2 BATTERY SAVE

The symbol "S" appears while battery save function is activated.

3 TONE ENCODER/TONE SQUELCH

The symbol "T" appears when tone encoder is active and "T SQL" when tone squelch (Decode) function is activated.

4 PRIORITY/DUAL WATCH

The symbol "PRI" appears when PRIORITY/DUAL WATCH function are activated.

5 SPLIT

The "⊕" symbol appears when the split function is activated.

6 TIMER SCAN

Another "T" symbol appears, to indicate that TIMER SCAN is activated. When the "T" symbol disappears, BUSY SCAN is activated.

7 OUTPUT POWER

When the symbol "L" is displayed, LOW power is active. The indicator "M" is for MID power and "H" for HIGH power.

8 DIALER

When the "M" symbol appears, the DIALER MEMORY is activated.

9 SHIFT

The symbols "+", "-" are used by the shift function.

10 DSQ

When "P" or "G" and "D.SQ" are displayed, DSQ functions are enabled. DSQ stands for DTMF squelch control.

11 VHF

The "V" symbol indicates that the VHF band has been selected.

12 FREQUENCY INDICATOR

Receive and transmit frequencies, offset and tone frequencies, channel steps, DSQ codes and dialer memory channel numbers are displayed in this area depending on the selected mode.

13 AUTO POWER OFF

"APO" appears when AUTO POWER OFF is activated.

14 ON AIR

The symbol "ON AIR" appears when transmitting.

15 S/R/F

In receive mode the "S/R/F" symbol and Signal/RF bars will be displayed to show signal strength. When transmitting occurs, the "ON AIR" symbol and Signal/RF bars indicate RF output power.

16 FREQUENCY DECIMAL POINT

When receive, transmit or offset frequencies are displayed on the LCD, the decimal point divides MHz and kHz.

17 TONE FREQUENCY DECIMAL POINT

When the Tone frequency is displayed, the decimal point divides Hz and 0.1 Hz.

18 PL

The "PL" symbol indicates that the PTT switch is locked. The radio will not transmit even if the PTT switch is pressed accidentally.

19 FL

"FL" stands for FREQUENCY LOCK. When FL is displayed, the command and control function keys are locked out. Utilizing this function prevents accidental use of command and control pad keys.

20 UHF

This symbol indicates that the "U" band has been selected.

5. GETTING STARTED (RECEIVING)

- Adjust the following switches and controls on the top of the radio.
POWER/UHF KNOB: OFF
VOLUME CONTROLS:
Fully Counter Clockwise
SQUELCH CONTROLS:
Fully Counter Clockwise
- Connect a battery or external 13.8 Volt DC Power Supply to the radio.
- Connect an antenna with the appropriate antenna connector to the top of the radio. The type of antenna fitting that is expected is a BNC type.
- Rotate the POWER knob clockwise until power is applied to the radio.
- Rotate the VHF volume control (left knob) and the UHF volume control (center knob) clockwise until a signal (or noise) is heard through the speaker. The display should be illuminated and indicate frequencies for both bands. The initial factory delivered settings for VHF are found in Table 4, UHF in Table 5.

VHF	
VFO Frequency:	145.000 MHz
Memory Frequency:	Empty
Channel Step (580T):	5 kHz
Channel Step (580E):	12.5 kHz
Shift:	None
Offset Frequency:	0.6 MHz
Memory Channel:	1
DSQ Setting:	None
Call Frequency:	145.000 MHz
Tone Setting:	None
Tone Frequency:	88.5
Transmitter Output:	Mid
Call Freq.(580T):	145.000 MHz
Call Freq.(580E):	145.000 MHz

TABLE 4 VHF Default Settings

UHF	
VFO Freq. 580T:	445.000 MHz
VFO Freq. 580E:	433.000 MHz
Memory Channel:	1
Channel Step (580T):	5 kHz
Channel Step (580E):	12.5 kHz
Shift:	None
Tone Setting:	None
DSQ Setting:	None
Call Freq.(580T):	445.000 MHz
Call Freq.(580E):	433.000 MHz
Offset Freq.(580T):	5 MHz
Offset Freq.(580E):	7.6 MHz
Tone Frequency:	88.5 Hz
Transmitter Output:	Mid

TABLE 5 UHF Default Settings

- Rotate the Main Tuning dial, and select an open frequency on each band. Rotate the squelch control counter-clockwise for each band until the "SRR" indicator disappears from each band on the LCD display.
- Select the desired band by pressing the VHF or UHF buttons. The VHF symbol will be displayed when VHF is enabled and UHF will be displayed when UHF is enabled.

NOTE

If external power source is connected, be sure to power off the radio before turning off the power supply.

5-1 KEY PAD DIRECT ENTRY

When frequency is selected by key pad direct entry, numbers will appear on the LCD display as they are entered on the key pad.

To enter frequency directly from the key pad perform the following. The following example will use the 2 meter frequency 146.52.

- Select the Main Band by pressing the **VHF** or **UHF** key.
- Enter the 100MHz digit first. Example: 1—.—
- Enter the 10MHz digit next. Example: 14—.—
- Enter the 1MHz digit next. Example: 146.—
- Enter the 100kHz digit next. Example: 146.5—
- Enter the 10kHz digit next. Example: 146.52—
- Enter the 1kHz digit last. Example: 146.520

If radio STEP is greater than 10kHz, the 10kHz digit will be the last digit to enter followed by a

higher pitch beep.

If radio STEP is set to 5kHz, enter the last digit.

5-2 STEP KEY

The STEP function is used to select desired incremental changes of receive/transmit frequencies, in steps of 5, 10, 12.5, 15, 20 or 25kHz. Use this feature as follows:

- Select the Main Band by pressing the **VHF** or **UHF** key.
- Press and hold the **FUNC** key, then press the **STEP** key. Change the channel step by using the Main Tuning dial, **E** or ***** keys.
- Select the Main Band by pressing the **VHF** or **UHF** key to set channel step and return to operating frequency.
- After channel step is set, the receive/transmit frequency will increase or decrease by the value selected when you turn the Main Tuning dial.

NOTE

The following rules apply to channel steps as indicated.

When 5 kHz channel step is selected, keys **0** and **5** are available for entry into the 1kHz digit.

When 10 kHz channel step is selected, keys **0**, **1**, **2**, **3**, **4**, **5**, **6**, **7**, **8** and **9** are available for entry into the 10kHz digit.

When 12.5 kHz channel step is selected, keys **0**, **1**, **2**, **3**, **5**, **6**, **7** and **8** are available for entry into the 10kHz digit.

When 15 kHz channel step is selected, keys **0**, **1**, **3**, **4**, **6**, **7** and **8** are available for entry into the 10kHz digit.

When 20 kHz channel step is selected, keys **0**, **2**, **4**, **6**, and **8** are available for entry into the 10kHz digit.

When 25 kHz channel step is selected, keys **0**, **2**, **5** and **7** are available for entry into the 10kHz digit.

5-3 KEYPAD ENTRY

When frequency is selected by key pad direct entry, numbers will appear on the LCD display

as they are entered on the key pad.

- Select the Main Band by pressing the **VHF** or **UHF** key.
- Begin by entering the 100 MHz digit.
- Enter the 10 MHz digit.
- Enter the 1 MHz digit.
- Enter the 100 kHz digit.
- Enter the 10 kHz digit. If the radio is in 10 kHz or higher step, a beep will sound and the band indicator will stop flashing.
- Enter the 5 kHz digit if the radio is set for 5 kHz step.

5-4 CLEARING ENTRY

To clear an error during key pad entry, you may:

- Press the **VHF** or **UHF** band key, or
- Press the **PTT** key.

5-5 MONO BAND FUNCTION

If you only want to use one band without distraction from the other band, follow these steps for mono band.

- Switch off the radio.
- Press either the **VHF** or **UHF** key while powering on the radio.
Restore dual band capability by pressing the inactive band key. If VHF is selected for mono band operation, press the **UHF** key to restore dual band operation.

6. TRANSMITTING

1. Make sure that you follow all steps set forth in the "GETTING READY" section (Section) first.
2. Select a frequency, shift direction, shift value, and PL tone frequency.
3. Check to see if the frequency is in use before transmitting.
4. Select appropriate transmitter output level by the switch located on the rear panel of the radio.
5. Press the **PTT** switch and speak approximately 5" from the microphone, located on the front of the radio.

6-1 POWER OUTPUT SETTING

There are three power settings on the DJ-580T/E. You may select either High (H), Medium (M) or Low (L) from the PO function on the front panel. Change power output levels by performing the following.

1. Press and hold the **FUNC** key, then press the **PO** key repeatedly to obtain the desired output power.

WARNING

It is possible to cause UHF receive interference while transmitting on VHF. To avoid this from happening, make sure that the VHF frequency x 3 does not equal the frequency on UHF. For example, if VHF transmit frequency is 146.190MHz the UHF frequency should not be set at 438.570MHz.

6-2 LOW LEVEL BATTERY MODE

This function allows for extended use due to power drop in battery. The " **FULL** " indicator will begin to flash when battery drops to approximately 6.2 volts. When you operate your squelch just on the threshold, it will begin to open at approximately 4.75 volts. The sensitivity and transmit power will begin to drop at this time compared to normal operation. The radio will continue to operate until approximately 4.50 volts. *This feature is available with DRY CELL BATTERIES ONLY.

7. TRANSCEIVER MODES

The DJ-580T/E has 3 modes; VFO mode, Memory mode and Call mode.

7-1 VFO MODE (Variable Frequency Oscillator)

The transceiver will be in VFO mode. This mode is used to change frequency and select the desired channel step, offset frequency (up to 15.995 MHz by 5 kHz), tone frequency (38 frequencies in Hz), Dual Watch, etc.

1. Select the Main Band by pressing the **VHF** or **UHF** key.

7-2 MEMORY MODE

The following guidelines will help you to program and manipulate memory channels. In memory mode, memory channels can be reviewed. Other features include Memory Scan, Memory Priority and Dual Watch. To select the memory mode, press the **MEM** key. The most recently used memory channel will display:

- Frequency
- Memory channel number
- Other programmed functions

7-2-1 PROGRAMMING A MEMORY CHANNEL (MW KEY)

To write functions to any memory channel, it is necessary to first set those functions in the VFO mode.

- Select VFO mode (VHF or UHF band key).
- Select the receive frequency.
- Select the repeater shift " **R** " or " **S** " or split
- Select the required offset. Consult your Repeater Directory.
- Select the proper CTCSS subaudible tone " **T** ". Consult your Repeater Directory.
- Select Tone Squelch (Decoder) " **SQL** ".
- Select Tone Frequency

After selecting and setting the required functions you can write (store) those functions to a memory channel as follows:

1. Select the Main Band by pressing the **VHF** or **UHF** key.
2. Select a frequency, shift direction, shift value, CTCSS subaudible tone, Tone squelch and Tone frequency.

3. Press the **MEM** key. A two digit memory channel number will be displayed on the LCD. If these digits are flashing, it means that this channel number has no information stored.
4. Rotate the Main Tuning Dial clockwise to choose the desired memory channel number (clockwise to increase, counter clockwise to decrease). Select the desired memory channel number (0 to 19).
5. Press and hold the **FUNC** key along with the **MEM** key to write (store) frequency to memory.
6. Press the MR key to exit.

An alternate method for programming the memory channel is provided as follows:

1. Select the Main Band by pressing the **VHF** or **UHF** key.
2. Press the **MEM** key. A two digit memory channel number will be displayed on the LCD. If these digits are flashing, it means that this channel number has no information stored.
3. Turn the Main Tuning Dial clockwise to choose the desired memory channel number (clockwise to increase, counter clockwise to decrease). Select the desired memory channel number (0 to 19).
4. Select a frequency, shift direction, shift value, CTCSS subaudible tone, Tone squelch and Tone frequency.
5. Press and hold the **FUNC** key along with the **MEM** key to write (store) to memory.
6. Press the **MEM** key to exit.

7-2-2 SCROLL MEMORY

Scrolling the VHF or UHF bank of memory channels up or down can be accomplished 1 of 2 ways.

MR KEY:

1. Press the **MEM** key to put the Main Band into Memory Channel mode. The memory channel number (0-19) will appear. A flashing channel number indicates to you that no information has been programmed into this memory channel. Turn the Main Tuning dial to increment and decrement the memory channel or use the **▲** / **▼** keys.
2. Press the **MEM** key to exit MEMORY MODE and return to VFO MODE. The two digit memory channel will disappear from the LCD display indicating that you have returned to

VFO MODE.

You can scan the memory channels with the **○** key, select to skip any memory channel with the ***⊖** key, or select the scan type with the **⊖** key. Refer to the section SCANNING FUNCTIONS (Section) for more information.

The DJ-580T/E has two (02) banks of memory channels:

1ST the VHF bank has 20 memory channels that are accessed with the ***⊖** key.

2ND the UHF bank has 20 memory channels that are accessed with the **⊖** key.

7-2-3 CANCELLING A MEMORY CHANNEL

1. Select the Main Band by pressing the **VHF** or **UHF** key.
2. Press the ***⊖** key.
3. **Rotate the Main Tuning Dial** to choose the desired memory channel number (clockwise to increase, counter clockwise to decrease). Select a non-flashing memory channel number (0 to 19).
4. Press and hold the **FUNC** key, then press the **⊖** key to cancel this memory channel. The two digit memory channel number will now begin to flash indicating that the contents of this memory channel has been cleared.

7-2-4 FREE VHF/UHF MEMORY CHANNELS

Using this feature will allow you to free up memory channels from either band and allocate to the other band for frequency storage.

EXAMPLE: FREE MEMORY CHANNELS

Lets say you wish that you had 25 programmable VHF memory channels but the radio comes defaulted to 20. No problem, that is why this feature has been included. Since the radio has 40 channels in total, 20 for each VFO, it is possible to allocate all 40 channels to one band for memory programming. This scenario would of course leave the other band with no programmable memory channels. Here's how to make it all happen.

1. Press and hold the **FUNC** key, then press the ***⊖** key. The symbol " FL " will appear on the LCD display.
2. Press and hold the **FUNC** key, then press

the **4** key. The number of allocated memory channels for each VFO will appear on each band display.

When the **Main Tuning Dial is rotated clockwise**, the number of possible **VHF memory channels will increase**. This number will increase while the allocated memory channels from the UHF side will decrease.

When the **Main Tuning Dial is rotated counter clockwise**, the number of possible **UHF memory channels will increase**. This number will increase while the allocated memory channels from the VHF side will decrease.

3. Press and hold the **FUNC** key, then press the ***⊖** key four (4) times to clear FL/PL from the display and exit beep tone level mode.

7-2-5 MEMORY TO VFO COPY FUNCTION

This function is used to copy details of a memory or call channel into a VFO.

1. Select the Main Band by pressing the **VHF** or **UHF** key.
2. Press the ***⊖** key.
3. Select a memory channel number by **rotating the Main Tuning dial**.
4. Press and hold the **FUNC** key, then press the **⊖** key. The information from the memory channel has been copied to the VFO, currently displayed.

7-3 CALL MODE

The CALL mode allows a single key to access an immediately desired programmed frequency. Each band has one Call Channel which can be accessed by **pressing the ○ key**. A preferred local repeater is usually programmed into the Call Channel. The **indicator C** appears on the LCD when Call Priority and/or Dual Watch function is active.

7-3-1 PROGRAMMING THE CALL CHANNEL (W KEY)

To write functions to a CALL Channel, it is necessary to first set those functions in the VFO mode.

- Select VFO mode (VHF or UHF band).

- Select the receive frequency.
- Select the repeater shift " **■** " or " **⊕** "
- Select the required offset. Consult your Repeater Directory.
- Select the proper CTCSS subaudible tone " **■** ". Consult your Repeater Directory.
- Select Tone Squelch (Decoder) " **■** SQL "
- Select Tone Frequency

After selecting and setting the required functions you can write (store) those functions into a CALL Channel as follows:

1. Select the Main Band by pressing the **VHF** or **UHF** key.
2. Select a frequency, shift direction, shift value, CTCSS subaudible tone, Tone squelch and Tone frequency.
3. Press and hold the **FUNC** key, then press the **○** key. The frequency selected in step 2 will be stored into the CALL channel. The " **⌈** " indicator appears on the LCD showing you that your current mode is CALL channel mode.
4. Press the **○** key again to return to previous mode and frequency.

7-3-2 ACTIVATING CALL CHANNEL

1. Select the Main Band by pressing the **VHF** or **UHF** key.
2. Press the **○** key. The CALL indicator " **⌈** " will appear on the LCD display.
3. Press the **○** key again to return to previous mode and frequency.

7-3-3 CALL CHANNEL TO VFO COPY FUNCTION

This function is used to copy details of a memory or call channel into a VFO.

1. Select the Main Band by pressing the **VHF** or **UHF** key.
2. Press the **○** key.
3. Press and hold the **FUNC** key, then press the **⊖** key. The information from the call channel has been copied to the VFO, currently displayed.

8. PRIORITY FUNCTIONS

The following priority functions are available:

- VFO Priority
- Memory Priority
- Call Priority (Dual Watch)

8-1 VFO PRIORITY

In this mode a VFO frequency is received for 4 seconds and a Memory frequency is received for a 1/2 of a second in a continuous cycle. Here is how it works:

1. Select the Main Band by pressing the **VHF** or **UHF** key.
2. Select and **enter a frequency**.
3. Press the **MEM** key to activate Memory mode.
4. **Rotate the Main Tuning Dial** to a desired Memory Channel that has been programmed. You may also use the **←** or **→** key to change memory channels.
5. Return to the Main Band VFO as you selected in step 1.
6. Press the **PRI** key to begin priority function. The LCD will display "PRI".
7. Press the **MEM** key to stop the priority function. The LCD will remove the flashing "PRI" from the display.

NOTE

When a signal is received on the memory channel a BEEP will be emitted once from the speaker. In **VFO priority**, the transmitter may be activated on either frequency. Press the PTT switch when the desired frequency is displayed on the LCD.

8-2 MEMORY PRIORITY

In this mode a Memory frequency is received for 5 seconds and a VFO frequency is received for 2 second in a continuous cycle. Here is how it works:

1. Select the Main Band by pressing the **VHF** or **UHF** key.
2. Select and **enter a frequency**.
3. Press the **MEM** key to activate Memory mode.
4. **Rotate the Main Tuning Dial** to a desired Memory Channel that has been programmed. You may also use the **←** or **→** to change memory channels.
5. Press the **PRI** key to begin priority function. The LCD will display "PRI".
6. Press the **MEM** key to stop the priority function. The LCD will remove "PRI" from

the display.

NOTE

When a signal is received on the VFO frequency a BEEP will be emitted once from the speaker. In **memory priority**, the transmitter may be activated on either frequency. Press the **PTT** switch when the desired frequency is displayed on the LCD.

8-3 CALL PRIORITY

The VFO frequency or Memory channel is scanned for approximately 1/2 second and the programmed CALL frequency is scanned for approximately 4 seconds.

1. Select the Main Band by pressing the **VHF** or **UHF** key.
2. If the CALL channel hasn't been programmed yet, refer to section for more information.
3. Enter a frequency into the VFO or select a Memory channel in memory channel mode.
4. Press the **CALL** key for approximately 1/2 second. Call priority will begin to cycle between the CALL channel and the selected VFO or memory channel.
5. Press the **PRI** key to begin priority function. The LCD will display "PRI".
6. Press the **CALL** key to stop the priority function. The LCD will remove "PRI" from the display.

NOTE

When a signal is received on the VFO frequency a BEEP will be emitted once from the speaker. In **CALL priority**, the transmitter may be activated on either frequency. Press the **PTT** switch when the desired frequency is displayed on the LCD.

8-4 DUAL WATCH FUNCTION

Unlike priority, there is no time period for listening between two modes. Dual Watch is a constant monitoring of two modes.

8-4-1 VFO/MEMORY DUAL WATCH

Perform the following for VFO/MEMORY DUAL WATCH.

1. Select the Main Band by pressing the **VHF** or **UHF** key. Enter a desired frequency.
2. Press the **MEM** key and select the desired memory channel.
3. Return to the VFO mode as selected in step #1.
4. Press and hold the **FUNC** key, then press the **DUAL** key. The radio will begin with the VFO frequency followed by the memory channel frequency. The cycling between these frequencies is approximately .5 second.
5. Press the VFO button as selected in step #1 to stop DUAL WATCH.

OPERATING HINT

Without stopping DUAL WATCH operation, you can enter a new frequency into the selected VFO and DUAL WATCH will continue automatically. Enter the new VFO frequency via the key pad. DUAL WATCH operation will be suspended while you are entering the new VFO frequency, but will resume operation after you have completed entry.

8-4-2 CALL/VFO DUAL WATCH

Unlike priority, there is no time period for listening between two modes. Dual Watch is a constant monitoring of two modes. Perform the following for CALL/VFO DUAL WATCH.

1. Select the Main Band by pressing the **VHF** or **UHF** key. Enter a desired frequency.
2. Press the **CALL** key. The CALL channel must be programmed.
3. Press and hold the **FUNC** key, then press the **DUAL** key. The radio will begin with the CALL frequency followed by the VFO frequency. The cycling between these frequencies is approximately .5 second.
4. Press the Main Band key as performed in step 1 to stop DUAL WATCH.

8-4-3 CALL/MEMORY DUAL WATCH

Unlike priority, there is no time period for listening between two modes. Dual Watch is a constant monitoring of two modes. Perform the following for CALL/MEMORY DUAL WATCH.

1. Press the **MEM** key and select the desired memory channel.
2. Press the **CALL** key. The CALL channel must

be programmed.

3. Press and hold the **FUNC** key, then press the **DUAL** key. The radio will begin with the CALL frequency followed by the memory channel frequency. The cycling between these frequencies is approximately .5 second.
4. Press the VFO button as selected in step #1 to stop DUAL WATCH.

9. SCANNING FUNCTIONS

The DJ-580T/E offers various scanning options and 3 scanning modes described a little later on in this section. First lets look at the scanning options, they are:

VFO Scan

Scans either band independently.

Program Band Scan (VFO Mode)

Scans programmed lower to upper frequencies. You may scan a range of frequencies.

Memory Scan

Each band may scan memory channels independently.

9-1 VFO SCAN

Each band may scan VFO channels independently. When in Band Scan mode the DJ-580T/E scans by Channel step, by 100 kHz or by 1 MHz steps. As the scan passes through any 500 kHz or 1 MHz point a tone will sound if the BEEP function is active.

1. Select the Main Band by pressing the **VHF** or **UHF** key twice. The purpose for pressing the band key twice is in the event you are in memory mode by mistake.
2. Press the **SCAN** key for approximately 1 second and release the SCN key. Use the Main Tuning dial or **B** or **▲** keys to scan in a particular direction.
3. Whether you are cycling upward or downward, during scan the decimal point will flash indicating that scanning has begun.
4. When a signal is received, scanning will stop and remain on that frequency. When channel goes quiet or Main Tuning Dial is rotated clockwise or counter clockwise, scanning will continue.
5. To cancel scanning press the **SCAN** key.
All 3 scan types can be applied to Band Scan.

9-1-1 PROGRAM BAND SCAN MODE (VFO MODE)

This scan option allows the scanning of a range of VFO frequencies. Each band may have independent scan ranges. The lower band limit is programmed into Memory Channel 18. The upper band limit is programmed into Memory Channel 19. You may initiate Program Band Scan from either VFO or Memory mode.

EXAMPLE: STORING LOWER/UPPER RANGES

1. Select the Main Band by pressing the **VHF** or **UHF** key, for example VHF.
2. Enter a desired Lower Frequency via the key pad, for example "146.000MHz".
3. Press the **MEM** key.
4. Rotate the Main Tuning Dial until "P1" is displayed.
5. Press and hold the **FUNC** key, then press the **MEM** key to store the selected Lower Frequency into memory.
6. Enter a desired Upper Frequency via the key pad like 146.100MHz.
7. Press the **MEM** key.
8. Rotate the Main Tuning Dial until "P2" is displayed.
9. Press and hold the **FUNC** key, then press the **MEM** key to store the selected Upper Frequency into memory.
10. Press and hold the **FUNC** key, then press the **MEM** key. The letter "P" will begin to blink on the display. Scanning from 146.000 to 146.100 has begun.
11. Press the Main Band key as performed in step 1 to stop this function. Pressing the **SCAN** key will also cease this function.

NOTE

The upper limit frequency and Lower limit frequency may be stored into either "P1" or "P2".

9-2 MEMORY SCAN MODE

This scan option allows the user to scan frequencies that have been programmed in any (or all) of the memory channels. Bands may be scanned individually or both bands may be scanned simultaneously.

1. Select the Main Band by pressing the **VHF** or **UHF** key twice. The purpose for pressing the band key twice is in the event you are in memory mode by mistake.
2. Press the **MEM** key.
3. Press the **SCAN** key. Use the Main Tuning dial to scan in a particular direction. You can also use the **B** or **▲** keys to scan in a particular direction.
4. Whether you are cycling upward or downward, during scan the decimal point will flash indicating that scanning has begun.

5. When a signal is received, scanning will stop and remain on that frequency. When channel goes quiet or Main Tuning dial is rotated clockwise or counter clockwise, scanning will continue.
6. Press the Main Band key as performed in step 1 to stop this function. Pressing the **SCAN** key will also cease this function.

9-2-1 MEMORY CHANNEL SKIP MODE

Memory Channel Skip permits unwanted memory channels to be skipped during memory scan. This step presumes that you have already programmed some/all memory channels.

1. Press the **MEM** key.
2. Rotate the Main Tuning Dial until the memory channel that you want to skip is displayed.
3. Press the **MEM** key. The decimal point will disappear from the frequency displayed, indicating this frequency will be skipped. Perform step 2 and 3 for each memory channel that you wish to skip.
4. To cancel Memory Channel Skip, press the **MEM** key again. The decimal point will re-appear, and that memory channel will now be restored to scan status.

9-3 SCANNING TYPES

The DJ-580T/E offers 3 different scanning modes as shown below. The initial factory setting is the Busy Channel Scan.

Busy Scan

Stops at a busy channel or frequency until clear. Two seconds after the signal ceases, scanning resumes.

Timed Scan

Stops at busy channel or frequency, then resumes scan 5 seconds later even if the channel remains busy. Scanning will also resume when a signal received ceases.

Selecting a Scan Type:

1. Select the Main Band by pressing the **VHF** or **UHF** key.
2. Press and hold the **FUNC** key, then press the **T** key. A black block with a white lettered T will appear, indicating to you that "Timed Scan" has been selected.

3. Press and hold the **FUNC** key, then press the **T** key again to leave "Timed Scan". The black block with a white lettered "T" will disappear from the LCD display. The DJ-580 will be in "Busy Scan" when not in "Timed Scan".

9-4 OTHER SCANNING INFORMATION

This subsection talks about all other information pertinent to radio scan.

9-4-1 DUAL BAND SCAN

You may want to scan both bands at the same time. You can perform that function by following this example.

EXAMPLE: DUAL BAND SCAN

1. Press the **VHF** key.
2. Press the **B** key for approx. 1 second.
3. Press the **UHF** key.
4. Press the **B** key for approx. 1 second.

9-4-2 DUAL BAND SCANNING WITH MEMORY PRIORITY

If you want to activate PRIORITY on both bands while SCANNING, no problem, follow this example.

EXAMPLE: DUAL BAND SCAN WITH DUAL BAND PRIORITY

1. Press the **VHF** key.
2. Press the **MEM** key and rotate Main Tuning dial for a desired memory channel.
3. Press the **VHF** key.
4. Press the **SCAN** key for approx. 1 second.
5. Press the **▲** key.
6. Press the **UHF** key.
7. Press the **MEM** key and rotate Main Tuning dial for a desired memory channel.
8. Press the **UHF** key.
9. Press the **SCAN** key for approx. 1 second.
10. Press the **▲** key.

10. REPEATER OPERATIONS

Amateur radio repeaters utilize separate transmitter and receiver sections. The transmitter frequency may be offset either above or below the receive frequency according to repeater coordination conventions.

10-1 SPLIT FREQUENCY FUNCTION

When standard offsets will not satisfy an input or output frequency, a split is utilized for this purpose. Split can be configured on the DJ-580 for VFO and MEMORY modes. The split frequency function will not operate in CALL mode.

10-1-1 VFO MODE SPLIT

Perform the following for VFO MODE SPLIT.

1. Select the Main Band (VFO) by pressing the **VHF** or **UHF** key. Enter a frequency into the VFO for your output (receive) frequency.
2. Press the **⊕** key. Program or select a frequency in any MEMORY channel for your input (transmit) frequency.
3. Enter VFO mode again. You are now in receive, while transmitting will divert to the MEMORY channel for the transmit frequency.
4. Press and hold the **FUNC** key, then press the **⊕** key repeatedly until the "⊕" appears on the display. The split setup is now complete.

10-1-2 MEMORY MODE SPLIT

Perform the following for MEMORY MODE SPLIT.

1. Press the **⊕** key. Program or select a frequency in any MEMORY channel for your input (transmit) frequency.
2. Select the Main Band (VFO) by pressing the **VHF** or **UHF** key. Enter a frequency into a VFO for your output (receive) frequency.
3. Press the **⊕** key again. You are now in receive, while transmitting will divert to the VFO frequency for the transmit frequency.
4. Press and hold the **FUNC** key, then press the **⊕** key repeatedly until the "⊕" appears on the display. The split setup is now complete.

10-2 REV KEY

In some areas there may be repeaters operating on repeater frequency pairs, the exact reverse

of another repeater in the area. That is, the input of one repeater is the output frequency of the other and vice versa. To avoid the inconvenience of reprogramming every time both repeaters are in range, the **REV** key allows instant reversal of the input and output frequencies and the offset direction. The REV function is also useful to check the repeater input to determine if another station is heard directly so you can go simplex. To activate the REV function:

1. Press and hold the **FUNC** key, then press the **REV** key. The repeater input frequency and opposite SHIFT indicator will appear on the LCD display panel.
2. Press and hold the **FUNC** key, then press the **REV** key again to cancel the REV function.

10-3 RESETTING RADIO

NOTE

Resetting the radio will erase all user programmed information (frequencies, shifts, offsets etc.) Make sure that this information has been written down before proceeding.

1. Make sure **radio is powered off**.
2. Press and hold the **FUNC** key in while turning on the radio via the power knob. The LCD will display 145.00 (VHF) and 445.00 (UHF).

NOTE

If you were to hold the **FUNC** key in and not let it go while powering up the radio, all display segments will be shown.

10-4 CTCSS ENCODE/DECODE

CTCSS encoding allows you to select the proper tone frequency to open another operators radio receiver or repeater. CTCSS decoding enables another operator to select the tone your receiver requires enabling you to hear them. Unlike Code Squelch operation (Refer to section for details), a specific tone frequency is used. Here's how to use CTCSS Encoding/Decoding.

1. Select the Main Band by pressing the **VHF** or **UHF** key.
2. Press and hold the **FUNC** key, then press the **⊕** key.
3. **Rotate the Main Tuning dial** to the desired

tone.

4. When the tone has been selected enter the Main Band by pressing either the **VHF** or **UHF** key.
5. Press and hold the **FUNC** key, press the **⊕** key repeatedly. Tone settings will cycle each time the **⊕** key is pressed. It cycles as follows on the LCD display:
 - The Tone Encoder is Enabled when the letter "E" is displayed on LCD.
 - The Tone Decoder Squelch function is enabled when the letter "D" and "SQL" is displayed on the LCD. When this function is active, you would expect a particular tone to open your radio receiver.
 - When the "E" and "SQL" is not displayed, the encoder/decoder is disabled.

EXAMPLE: TONE ENCODER/DECODER

Radio for Joe	Radio for Linda
Tone set: 100.0 "E" displayed (ENCODE)	Tone set: 100.0 "D" and "SQL" displayed (DECODE)

- A) Radio operator "Joe" is calling "Linda". The interesting point here is that when the radio that Linda is using displays "E" and "SQL", nothing will be heard through her radio speaker when squelch is opened up (fully counter clockwise). You will notice however that the "S/RF" indicator will be shown on the LCD when squelch is opened.
- B) The only way that Linda will hear Joe is for Joe to send the proper tone to open Linda's radio receiver. If Joe doesn't send the right tone, Linda's radio will remain silent.

11. AUTOPATCH OPERATION (AUTOMATIC DIALER)

The DJ-580T/E offers three automatic dialer memories. A telephone number may be entered in either the VHF or the UHF frequency mode. The stored telephone number is transmitted on whichever band is selected as the Main Band.

11-1 PROGRAM AUTODIAL NUMBER

To enter a telephone number, perform the following:

1. Press and hold the **FUNC** key, then press the **▲** key. The selected VFO frequency display will clear and display “1” or “2” or “3”. Rotate the Main Tuning dial clockwise or counter-clockwise to obtain a desired dialer memory. The telephone symbol will display on the LCD and flash, indicating that the dialer memory is ready to accept the number to be stored. You may enter up to 16 numbers, letters and symbols, four at a time in four groups.
2. The telephone number or codes should be entered in order from the beginning. The following characters can be used:
0-9, A-D, *, #
3. Press and hold the **FUNC** key, then press the **▲** key to store the entered telephone number or codes. The telephone symbol stops flashing and is on steady to show that this function is active.
Proceed to Section to transmit the dial sequence. Clear out dialer memory to enter a new sequence.

11-2 CLEAR DIALER MEMORY

1. Press and hold the **FUNC** key, then press the **▲** key.
2. Rotate the Main Tuning dial to the dialer memory you wish to clear.
3. Press and hold the **FUNC** key, then press the **☺** key followed by the **A** once again.

11-3 CORRECTING CODES IN DIALER MEMORY

1. Press and hold the **FUNC** key, then press

the **▲** key.

2. Rotate the Main Tuning dial to the dialer memory you wish to make a correction in.
3. Press and hold the **FUNC** key, then rotate the Main Tuning dial until the sequence of digits you wish to correct have just exited the display.

EXAMPLE: CORRECTING DIALER CODES

Programmed number is 123567890, but you forgot 4!

1. Press and hold the **FUNC** key, then press the **▲** key.
2. Rotate the Main Tuning dial to the dialer memory you wish to make a correction in.
3. Press and hold the **FUNC** key, then rotate the Main Tuning until the numeral 3 is displayed.
This represents the last digit displayed on the LCD.
These digits are hidden just right of last digit shown.
123 567890
4. Now enter **4567890**. After you play with this for awhile you will see how it works.

11-4 TRANSMIT AUTODIAL NUMBER

After performing the steps in section, perform the following steps to transmit the programmed number.

1. Verify that the telephone symbol appears on the LCD display.
2. Press the **PTT** switch to transmit the autodial sequence.

HINT

If the repeater autopatch requires an entry of an access code as part of the telephone number, enter the code first, then the telephone number. All digits will be transmitted. In some cases you would have to enter the autopatch code manually, then use the dialer.

11-5 MANUAL DIAL

In some instances you may want to dial a number manually. perform the following steps.

1. The telephone symbol should not appear on your display. If it does, press and hold the **FUNC** key, then press the **▲** key, the **☺** key and finally the **▲** key again.
2. Press and hold the **PTT** key.
3. Now dial the number on your keypad as you would a telephone.

11-6 DISABLE AUTODIAL

1. Press and hold the **FUNC** key, then press the **▲** key, the **☺** key and finally the **▲** key again.

12. DIGITAL SQUELCH (DSQ)

DSQ stands for DTMF Squelch Control. DSQ is very versatile and will allow you to:

- Make a transmission and be heard by a group.
- Place a private call to a selected person in a group.
- Call a single operator.
- Straight DSQ transmission

This feature is achieved by use of DTMF Tones that will either open (or keep closed) the DJ-580T/E. In this section you will learn how to transmit and receive the DSQ SCHEME! A radio must be DSQ compatible to take advantage of these features.

12-1 DSQ SCHEME

Before we get started let's look at the DSQ tone structure. Depending on the transmission type (Group, Private etc.), a particular tone sequence will be sent. The tone structure is broken down into the following areas:

- **GROUP** Code
3 digit sequence
- **OTHER'S** Code
3 digit sequence
- **OWN** Code
3 digit sequence
- **MISC** Codes

The following explanation of each area will help you to fully understand how each is utilized.

3 DIGIT "GROUP" CODE

By programming a 3 digit group code your members of a group would receive a common transmission. Perhaps this group wouldn't want to hear a transmission meant for another group that has another 3 digit code sequence.

EXAMPLE: GROUP CODE

Lets say that you are helping the local police department find a missing child. They have split 10 radio operators into 2-five person teams. Let's call them team 1 and team 2.

Each member of team 1 has a radio with a group code of 111.

Each member of team 2 has a radio with a group code of 222.

The police have just found evidence that the child is definitely located in team 2 territory. The central

transmission point now needs to contact the members of team 1 and notify them that their search area must be changed. They will send out a 111 group code (tone sequence) to team 1. By virtue of the group code 111, all members of team 1 will hear the message and team 2 will hear nothing on their radios. A separate transmission to group 2 could be placed with specific updated information!

3 DIGIT "OTHER'S" CODE

This code is used as an identifier of another station. In other words, it is the other persons "own" code.

EXAMPLE: OTHERS CODE

Lets say that an individual in team 1 needs to be given some specific information. The receiving stations identifier is referred to as the other's code. We will send that person the information by virtue of their 3 digit "own" code. You must enter their "own" code into your "others" code field.

3 DIGIT "OWN" CODE





A transmitting station uses 3 digits as a personal identification number. A receiving station uses this code to identify who called them.

EXAMPLE: OWN CODE

Lets say that you will receive some specific information. The other person will need to know your "own" code before your radio will receive a private call. Your "own" code is also necessary, because the other person receiving your message will see your "own" code displayed on their radio LCD.

MISC CODES



16 numbers, letters and symbols can be used for coding. Here's what you can use;

An "H" will appear on the LCD when the  is entered and upside down  will appear when the  is entered. The  sign is used as a wild card. Refer to WILDCARD for more information.

12-2 PROGRAMMING ALL DSQ CODES

Place your radio in front of you. The following

steps get your radio set for DSQ operation.

1. Select the Main Band by pressing the VHF or UHF key.
2. Press and hold the  key, then press the  key. The LCD display will indicate "A-000".
3. Enter 3 digits for the group that YOU want to call. In other words, a unique calling code for a specific group.

EXAMPLE: PROGRAM 1ST GROUP CODE

"A-123"

4. Rotate the Main Tuning dial clockwise until "b-000" is displayed on the LCD.
5. Enter 3 digits for another group that YOU might call. This is an additional group calling code.

EXAMPLE: PROGRAM 2ND GROUP CODE

"b-456"

6. Rotate the Main Tuning dial clockwise until "P-000" is displayed on the LCD.
7. Enter 3 digits for your "own" Personal code. This is your unique identification code.

EXAMPLE: PROGRAM YOUR OWN CODE

"P-100"

8. Rotate the Main Tuning dial clockwise until "Y-000" is displayed on the LCD.
9. And now you must select the "others" 3 digit code. This is the operator you're calling. Lets say you're calling operator 200, enter "200" on the keypad.



EXAMPLE: PROGRAM THE OTHERS CODE

"Y-200"

10. Rotate the Main Tuning dial clockwise until "nn-00" is displayed on the LCD.
11. Enter a two digit code that will become the Digital Signal Message.

EXAMPLE: DIGITAL SIGNAL MESSAGE

"nn-07"

12. Press the  or  key to end setup. Only radios with DSQ functionality are capable of receiving and/or transmitting DSQ tasks. These tasks are described in the following sub-sections, have fun!

12-3 DSQ MODES







This section will address all functions of DSQ

and describe how they should be used. Only through experimentation of DSQ will you get the hang of it. DSQ functionality comes in various flavors, and they are shown in the following table.

DSQ FUNCTION	LCD DISPLAY
Straight DSQ	D.SQ
Group Calling	G D.SQ
Private Calling In A Group	G P D.SQ
Private Call	P D.SQ

12-3-1 TRANSMITTING (CODE SQUELCH)

Coded Squelch is a unique 3 digit sequence, when sent to another unit **configured only for D.SQ**, will open the receiver for reception. It's always a good idea to have a cheat card that lists each units identifier (own code) and group codes.

1. Select the Main Band by pressing the  or  key.
2. Press and hold the  key, then press the  key.
3. Rotate the Main Tuning dial and select either "A-" for GROUP A or "b-" for GROUP B. Each group should have a unique identifier code. If either GROUP A or B doesn't contain the desired 3 digit code, enter it in at this time via the keypad.
4. Return to the Main Band as selected in step 1.
5. Press the  key several times until "D.SQ" displays on the upper right-hand corner of the LCD.
6. When you press the  key, the Code Squelch is transmitted automatically. At the conclusion of the 3 digits being transmitted, the operators radio (who you are calling) receiver will accept your transmission.

12-3-2 RECEIVING (CODE SQUELCH)

If the received Code Squelch signal matches the set Code Squelch code, "D.SQ" will begin to flash on the LCD display. In addition, an audible alert will be heard through the speaker.

If the receiver is on receive mode by code squelch, it is possible to communicate within 1.5 seconds after a received signal is clipped.

12-3-3 TRANSMITTING (GROUP CALLING)

When you select this option, you will be able to contact many operators that collectively make up a **group**. If operators with compatible DSQ functionality are configured correctly, and all have the same group code programmed, their radios should open and receive your call. It's always a good idea to have a cheat card that lists each units identifier (own code) and group codes. Here's what you have to do.

1. Press the **[E]** key.
2. **Rotate the Main Tuning dial** and select either "A-" for GROUP A or "B-" for GROUP B. Each group should have a unique identifier code.
3. Press the **[E]** key several times until "G D.SQ" displays on the upper right-hand corner of the LCD.
4. When you press the **[PTT]** switch, the GROUP code selected will be transmitted to all units in the GROUP.

If you are using GROUP A in step 2 and wish to change to GROUP B, follow steps 1-4 again.

The following DSQ code is transmitted as shown:
(3 DIGIT GROUP CODE) * (3 DIGIT OWN CODE)

12-3-4 RECEIVING (GROUP CALLING)

To receive DSQ coded calls in GROUP CALLING, setup your radio for **G DSQ** as follows:

1. Press and hold the **[FUNC]** key, then press the **[E]** key until "G D.SQ" appears on the LCD display.

When the received DSQ code matches the first 3 digits of your display (group code), the "G D.SQ" indicator will begin to flash. If the BEEP is off, the squelch will open for as long as the calling operator is transmitting. If the BEEP is on, an audible beep will be emitted from the radio and the indicator will display which group is calling. Reset the display by pressing the Main Band key or PTT.

12-3-5 TRANSMITTING (PRIVATE CALLING IN A GROUP)

It's always a good idea to have a cheat card that lists each units identifier (own code) and group codes.

1. Press the **[E]** key.
2. Rotate the Main Tuning dial and select either "A-" for GROUP A or "B-" for GROUP B. Each group should have a unique identifier code.
3. Press the **[E]** key several times until "G D.SQ" displays on the upper right-hand corner of the LCD.
4. Press the **[PTT]** switch to transmit the DSQ code or press the VFO key for the band you are working.
The following DSQ code is transmitted as shown:
(3 DIGIT GROUP CODE) (1 DIGIT OTHERS CODE) * (1 DIGIT OWN CODE)

12-3-6 RECEIVING (PRIVATE CALLING IN A GROUP)

To receive DSQ coded calls in PRIVATE CALL IN A GROUP, setup your radio for GPDSQ as follows:

1. Press and hold the **[FUNC]** key, then press the **[E]** key until "G D.SQ" appears on the LCD display.

When the received DSQ code matches the first 3 digits of your group and your own code, the DSQ "G D" indicator will begin to flash. If the BEEP is off, the squelch will open for as long as the calling operator is transmitting. If the BEEP is on, an audible beep will be emitted from the radio and the indicator will display which group is calling. Reset the display by pressing the Main Band key or **[PTT]**.

12-3-7 TRANSMITTING (PRIVATE CALL)

This option would be used when someone is calling only you. This is different from encode/decode because you determine your own identification code and not a subaudible tone. It's always a good idea to have a cheat card that lists each units identifier (own code) and group codes.

1. Press the **[E]** key.
2. Press the **[E]** key several times until "D.SQ" displays on the upper right-hand corner of the LCD.
3. Press the **[PTT]** key to transmit the DSQ code or press the VFO key for the band you are working.
The following DSQ code is transmitted as shown:
(3 DIGIT OTHERS CODE) * (3 DIGIT OWN CODE)

12-3-8 RECEIVING (PRIVATE CALL)

To receive DSQ coded calls in PRIVATE CALL, setup your radio for **P D.SQ** as follows:

1. Press and hold the **[FUNC]** key, then press the **[E]** key until "D.SQ" appears on the LCD display.

12-4 ERROR CODE

When the "Other's" private code is not confirmed the LCD display will indicate "Er"

12-5 TIMING CONSIDERATIONS

It is possible to delay the time to transmit codes to about 750ms after the PTT key is pressed.

1. Press and hold the **[FUNC]** key, then press the **[E]** key. The LCD display will display "FL".
2. Press and hold the **[FUNC]** key, then press the **[A]** key. The LCD display will display "d-750" or "d-450". Repeat this step until the desired selection is made.
3. Press and hold the **[FUNC]** key, then press the **[E]** key. Repeat this step until "FL" and "PL" is absent from the display.

12-6 DSQ WILDCARDS

The "#" symbol is a wildcard that may be substituted for any one digit, letter or symbols used in DSQ codes. When the "#" symbol is entered it appears on the LCD display as an upside down A. The wildcard allows for the combination of many groups. If the first or first and second digits of several group codes are

the same, you can replace the second and third digits (or just third digit) with a "#" mark, and thus transmit to all those groups.

EXAMPLE: WILDCARDS

1. Enter the 2 meter frequency of 146.520.
2. Press and hold the **[FUNC]** key, then press the **[E]** key. Select any code squelch memory channel.
3. Release the **[FUNC]** key now and select a 3 digit code squelch code using the keypad.
Example: Enter the 3 digit code 1#5.
4. Press the **[FUNC]** key to return the LCD display to operating frequency.

Example: Now you will see on the LCD display P45.52.

5. Press the **[E]** key repeatedly (2 times) until "L" appears in the 100 MHz digit location.

Example: C45.620

If the incoming coded calls are anyone with a group code as follows, the call will be received by your radio.

- 105 through 195
- 1A5 through 1D5
- 1*5
- 1#5

6. When you receive a call from another station, the "L" will flash on and off for as long as the other operator is transmitting. Your radio has already memorized who was calling you, so press the **[PTT]** switch and you will transmit to that station directly. When you have completed your QSO, enter the wildcard sequence again to open your radio to all other stations again.

12-7 DIGITAL SIGNAL MESSAGE

This function allows you to send or receive messages consisting of 2 digit codes.

12-7-1 TRANSMITTING DIGITAL SIGNAL MESSAGE

You can retain 1 signal message in the transmitter memory.

1. Press and hold the **[FUNC]** key, then press the **[E]** key.
2. **Rotate the Main Tuning dial** and select a message memory channel "nn".

3. Enter a 2 digit message code. This is a code that has been predetermined and understood by the operating parties.
4. Press the **VHF** or **UHF** key to end setup.
5. Set the appropriate paging function (D.SQ, G D.SQ etc).
6. Press the **PTT** key to transmit the DSQ code. Continue to hold the **PTT** key and press the **0** key.

What the receiving operator will see on the display will be the unit number of the calling station followed by the 2 digit code. The following is the sequence sent:
(2 DIGIT SIGNAL MESSAGE)

12-7-2 RECEIVING DIGITAL SIGNAL MESSAGE

1. Set the appropriate paging function (D.SQ, G D.SQ etc).
2. When the appropriate codes are received, your receiver will open to hear the calling operator. When the digital signal message is sent shortly after the initial transmission, you will see on the LCD display the 3 digit calling station followed by a - and then the 2 digit digital signal message.

12-7-3 TRANSMITTING WITH DIGITAL SIGNAL DISPLAYED

While a digital signal message is displayed, press the **PTT** switch. Your signal will be transmitted back to the station calling by using the displayed DSQ settings. The frequency will return to your LCD display.

12-7-4 REVIEW DIGITAL SIGNAL MESSAGE MEMORY

You can store up to 3 previously received digital signal messages. The first two memories store the messages in received order. The third memory stores the latest message. These messages display the 3 digit calling station followed by the 2 digit message. Here's how to view digital signal message memory.

1. Press and hold the **FUNC** key, then press the **AMESS** key. Select any code squelch memory channel. The latest message will be displayed on the LCD display.
2. Rotate the Main Tuning dial to review the previously sent messages in "n i" through

"n i". You can also use the arrow keys to review these messages.

12-7-5 CLEARING MESSAGE MEMORY

If you find it necessary to clear out messages, proceed with the following steps.

1. Select the memory number and press the **MEM** key once to clear out that location.

13. CROSSBAND REPEATER

The DJ-580 is capable of crossband repeat. To simplify matters, it means that when you transmit on one band it is simultaneously heard on the other band. Ok you want to set up a crossband repeater I hear you say, right! Remember that this is not a repeater but a crossband repeater or crossband link. Here are a few things to remember about crossband repeat:

1. When crossband repeat is active, you cannot change frequencies or utilize other functions with the exception of crossband deactivation.
2. Set squelch threshold before you activate crossband repeat.
3. No radio modification is necessary to activate this function.
4. This isn't a 100% duty cycle repeater. If the radio becomes extremely hot to the touch, the radio should be allowed a cool down time.

13-1 ACTIVATE CROSSBAND REPEATER

Here are the steps for crossband repeat.

1. Rotate the volume controls for the VHF and UHF bands fully counter-clockwise.
2. Press and hold the **FUNC** key, then press the **MEM** key. The LCD should display " FL ".
3. Press each key once as follows: #, 5, 0 and 8. You should notice that the word " OPEN " displays on the LCD and the opposite band indicator will begin to blink.
4. Press the **PTT** switch and release it. The radio is now in crossband repeat. When a signal is received on one band, it will be retransmitted onto the other band.

13-2 DEACTIVATE CROSSBAND REPEATER

To return to original mode perform the following:

1. Press and hold the **FUNC** key, then you will press the **MEM** key 4 times. After you press it the first time the LCD will display " CLOSE ". This indicates to you that crossband repeat has been disabled. The other 3 times that you press the **MEM** key will turn off the " FL " and " PL " indicators.

14. FULL DUPLEX OPERATION

The principles of Full Duplex operation is very much like a telephone. The idea behind this is that when you are talking (let's say) on 2 meters you will hear the transmission from the other station on the 440 band. He will hear you on 2 meters.

YOUR STATION		OTHER STATION
TRANSMIT ON	→	RECEIVE ON
2 METERS		2 METERS
RECEIVE ON	←	TRANSMIT ON
440 BAND		440 BAND

14-1 ENABLE SPEAKER FULL-DUPLEX

Enabling the speaker will cause feedback unless an external earphone or headset is used.

1. Press and hold the **FUNC** key, then press the **PL** key. The LCD should display " FL ".
2. Press and hold the **FUNC** key, then press the **S** key. The LCD should display "Fd-an". Repeat this step until the field indicates "Fd-an".
3. Press and hold the **FUNC** key, then press the **PL** key repeatedly until the " FL " and " PL " indicators are absent from the LCD display.

14-2 DISABLE SPEAKER SEMI-DUPLEX

Perform the following steps:

1. Press and hold the **FUNC** key, then press the **PL** key. The LCD should display " FL ".
2. Press and hold the **FUNC** key, then press the **S** key. The LCD should display "Fd-aF". Repeat this step until the field indicates "Fd-aF".
3. Press and hold the **FUNC** key, then press the **PL** key repeatedly until the " FL " and " PL " indicators are absent from the LCD display.

15. AIRCRAFT MODIFICATION

The radio will not have to be opened and modified to receive aircraft. This procedure isn't difficult if you take your time. If you are unsure of your ability to perform this modification, please find someone with this know how!

NOTE

Don't even think of performing this modification unless you have the right tools and temperment.

1. Turn the radio off and remove the battery pack.
2. Look at the bottom of the radio, with the top upwards as shown.

Front of Radio

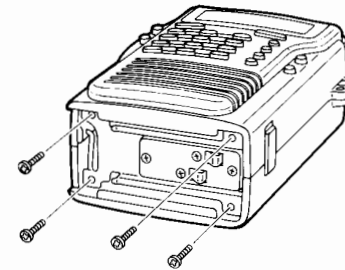

Remove these screws

BOTTOM VIEW SHOWN

Remove these 4-screws very carefully. They are very short screws (believe me, they are still in my rug), so work over an area that will catch the screws when removed.

3. Carefully remove battery terminal plate. Located a RED looped jumper wire. Remove or cut (tape exposed ends) this jumper wire.
4. Make sure that during reassembly you don't forget battery lock clip is in place.
5. Reset the radio (Refer to Section 10-3).
6. To go to Airband, press and hold the **FUNC** key, then press the **VHF** key.
7. Repeating this step will return to FM mode.
8. Enjoy a hot airband receiver. You will be able to enter a frequency range from 108-142.995MHz. The receiver will actually begin around 110MHz.

	Page	SPEAKER JACK	16
<ACCESSORIES>	4	STEP KEY	11
OPTIONAL	4	T.SQL KEY	12
STANDARD	4	TMS/VCS KEY	14
<AIRCRAFT MODIFICATION>	41	tone key	12
ANTENNA CONNECTOR	16	UHF BAND KEY	10
APO KEY	13	VHF BAND KEY	10
CLEAR DIALER MEMORY	32	DIAL M KEY	32
CORRECTING CODES IN DIALER MEMORY	32	<DSQ> CLEARING MESSAGE MEMORY	38
<AUTOPATCH> AUTOMATIC DIALER	32	DIGITAL SIGNAL MESSAGE	37
DISABLE AUTODIAL	33	DIGITAL SQUELCH	34
MANUAL DIAL	32	DSQ MODES	35
PROGRAM AUTODIAL NUMBER	32	ERROR CODE	37
TRANSMIT AUTODIAL NUMBER	32	PROGRAMMING ALL DSQ CODES	34
BATTERY LOCK BUTTON	17	RECEIVING (CODE SQUELCH)	35
BEEP KEY	13	RECEIVING (GROUP CALLING)	36
BS KEY	15	RECEIVING (PRIVATE CALL)	36
<CALL MODE>	24	RECEIVING (PRIVATE CALLING IN A GROUP)	36
ACTIVATING CALL CHANNEL	25	RECEIVING DIGITAL SIGNAL MESSAGE	38
COPY TO VFO FUNCTION	24	REVIEW DIGITAL SIGNAL MESSAGE MEMORY	38
PROGRAMMING THE CALL CHANNEL	24	TIMING CONSIDERATIONS	37
CALL PRIORITY	26	TRANSMITTING (CODE SQUELCH)	35
CALL/CALL.W KEY	15	TRANSMITTING (GROUP CALLING)	36
CLEARING ENTRY	21	TRANSMITTING (PRIVATE CALL)	36
<CROSSBAND REPEATER> ACTIVATE CROSSBAND REPEATER	39	TRANSMITTING (PRIVATE CALLING IN A GROUP)	36
DEACTIVATE CROSSBAND REPEATER	39	TRANSMITTING DIGITAL SIGNAL MESSAGE	37
CTCSS ENCODE/DECODE	30	TRANSMITTING WITH DIGITAL SIGNAL DISPLAYED	38
DECODE	30	WILDCARDS	37
T.SQL/TONE F KEY	12	DSQS KEY	14
<DESCRIPTIONS> DUAL KEY	13	<DUAL WATCH>	26
FL/PL KEY	10	CALL/MEMORY	27
FRONT PANEL CONTROLS	10	CALL/VFO	27
GP DSQ/DSQS KEY	14	VFO/MEMORY	26
LAMP KEY	15	<FREQUENCY> FREQUENCY INDICATOR	10
LCD DISPLAY PANEL	18	STEP KEY	11
MESS KEY	11	<FREQUENCY COVERAGE> AMERICAN	5
MICROPHONE	10	EUROPEAN	5
MONI/BS KEY	15	<FRONT PANEL> LCD DISPLAY	10
MR/MW KEY	14	FRONT PANEL CONTROLS	10
PO KEY	12	FUNCTION KEY	10
PRI/DIAL M KEY	11	GP DSQ/DSQS KEY	14
REV KEY	11		
SCN/PS KEY	14		
SKIP/M TO V KEY	14		
SPEAKER	10		

<KEYPAD> CONTROL KEYPAD	10	<SPECIFICATIONS>	2
KEYPAD ENTRY	20	EUROPEAN FREQUENCY COVERAGE	5
LOW LEVEL BATTERY MODE	22	GENERAL	5
M TO V KEY	14	RECEIVER	5
MAIN TUNING DIAL	16	<TRANSMITTER>	3
<MEMORY CHANNEL> SKIP MODE	34	U.S. FREQUENCY COVERAGE	5
MEMORY MODE	23	<SQUELCH> UHF	16
CANCELLING A MEMORY CHANNEL	29	VHF	16
FREE VHF/UHF MEMORY CHANNELS	24	<TOP PANEL> Controls and Functions	16
MEMORY TO VFO COPY FUNCTION	24	TRANSCEIVER MODES	23
PROGRAMMING A MEMORY CHANNEL (MW KEY)	23	CALL MODE	27
SCROLL MEMORY	23	MEMORY MODE	24
MEMORY PRIORITY	26	<VFO>	24
MEMORY SCAN	28	TRANSMITTING	23
MEMORY CHANNEL SKIP MODE	29	VFO MODE	23
MESS KEY	11	VFO PRIORITY	26
<MODIFICATION> AIRCRAFT	41	VFO SCAN	28
MONO BAND FUNCTION	21	<VOLUME CONTROL> UHF	16
MR KEY	14	VHF	16
MR/MW KEY	14		
MW KEY	14		
<POWER> OUTPUT SETTING	22		
PO KEY	12		
PRI KEY	11		
<PRIORITY FUNCTIONS> CALL PRIORITY	28		
MEMORY PRIORITY	26		
VFO PRIORITY	26		
<REPEATER OPERATIONS> MEMORY MODE SPLIT	30		
REV KEY	30		
SPLIT FREQUENCY FUNCTION	30		
VFO MODE SPLIT	30		
RESETTING RADIO	30		
REV KEY	30		
<SCANNING> DUAL BAND SCAN	32		
DUAL BAND WITH MEMORY PRIORITY	29		
MEMORY SCAN	28		
PROGRAM BAND SCAN MODE	28		
SCANNING TYPES	28		
VFO SCAN	28		