Ambient Weather OBSERVERIP Receiver User Manual



Table of Contents

1.	Introduction.....	2
2.	Parts List	2
3.	ObserverIP Receiver	2
3.1	Hardware Requirements.....	2
3.2	Software Requirements	3
3.3	ObserverIP Connections.....	3
3.4	Finding the ObserverIP from your computer	4
3.4.1	PC Users.....	4
3.4.2	Mac Users	5
3.4.2	Linux Users.....	6
3.5	Local Device Network Settings (optional).....	7
3.6	Weather Network Settings.....	8
3.6.1	WeatherUnderground.com	9
3.6.1.1	Creating a WeatherUnderground.com Account.....	9
3.6.1.2	Viewing your Data on Wunderground.com	9
3.6.1.2.1	Web Browser.....	9
3.6.2	AmbientWeather.net.....	10
3.6.2.1	Creating an AmbientWeather.net Account	10
3.6.3	Additional AmbientWeather.net Features.....	12
3.6.3.1	IFTTT	12
3.6.3.2	Compatible with Alexa	13
3.6.3.3	Works with Google Assistant.....	13
3.7	Station Settings	14
3.7.1	Weather Station Settings	14
3.7.2	Time Zone Setting.....	14
3.7.3	Daylight Savings Time.....	14
3.7.4	Units of Measure.....	15
3.8	Live Data.....	15
3.8.1	Reset and Change Rain Totals.....	15
3.9	Calibration.....	16
3.9.1	Relative Barometric Pressure Calibration Example.....	17
3.10	Adding Additional Sensors	20
3.10.1	Indoor/Outdoor Thermo-Hygrometer, 8 Channel (optional, Model WH31B).....	20
3.10.2	Sensor Placement.....	22
4.	Updating Firmware	23
4.1	PC Users.....	23
4.2	Mac Users	25
5.	Glossary of Terms	27
6.	Specifications.....	28
6.1	Wireless Specifications	28
6.2	Measurement Specifications	28
6.3	Power Consumption.....	28
7.	Troubleshooting Guide.....	28
8.	Liability Disclaimer	31
9.	FCC Statement.....	31

1. Introduction





Thank you for your purchase of the OBSERVERIP Receiver. The following user guide provides step by step instructions for installation, operation and troubleshooting. To download the latest manual, firmware upgrades and IP Finder Tools, visit:

<http://www.ambientweather.com/observerip.html>

For help, please visit:

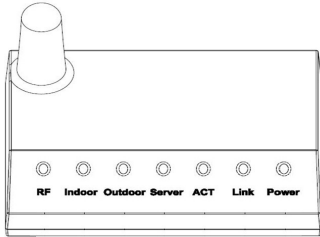
[ObserverIp Download Center](#)

2. Parts List

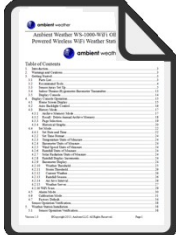
QTY	Item	Image
1	ObserverIP Receiver Dimensions (LxWxH): 3x2x1”	
1	5V DC Adaptor	
1	Ethernet Cable	
1	IP Module Reset Tool	
1	User manual	

3. ObserverIP Receiver

3.1 Hardware Requirements

1. Broadband router
2. An “always-on” connection to the Internet. A high speed DSL or cable internet connection that maintains constant connection to the internet.

3. AC Power

3.2 Software Requirements

An IP scan tool is required to locate the ObserverIP on the network.

Important Note: Download ObserverIP tools at the following location:

[ObserverIp Download Center](#)

3.3 ObserverIP Connections

Connect the ObserverIP receiver power jack to AC power with the power adapter (included), as shown in Figure 2, reference 10.

Connect the ObserverIP receiver to your router using the Ethernet cable (included), as shown in Figure 2, reference 8.

Place the sensor array and indoor thermo-hygrometer transmitter about 5 to 10 feet from the ObserverIP receiver and wait several minutes for the remote sensors to synchronize with the receiver. Once synchronized, the Indoor blue LED (Figure 1, reference 2) and Outdoor blue LED (Figure 1, reference 3) will be illuminated.

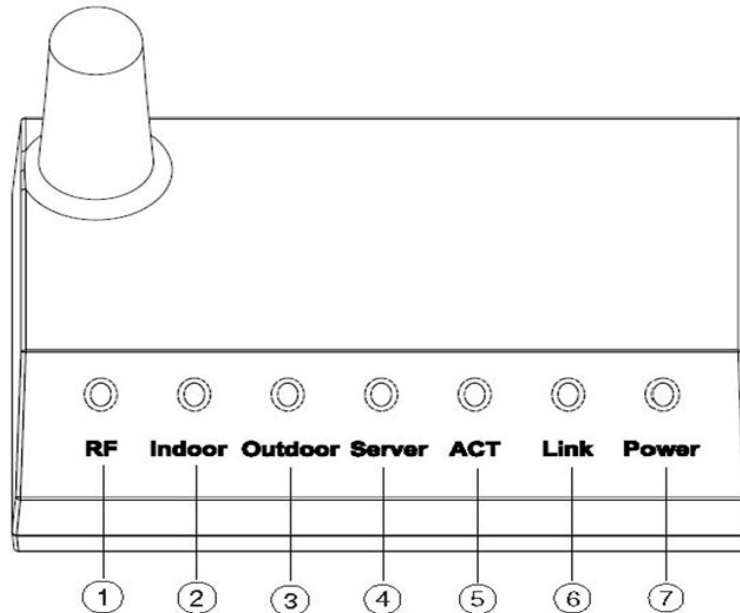

Ref.	LED	Description
1	RF	On when radio frequency receiver is operating properly
2	Indoor	On when indoor sensor received
3	Outdoor	On when outdoor sensor array received
4	Server	On when connected to Wunderground.com internet hosting service
5	ACT	Flashes when there is internet activity
6	Link	Connected to the Internet (or router)
7	Power	AC Power connected

Figure 1

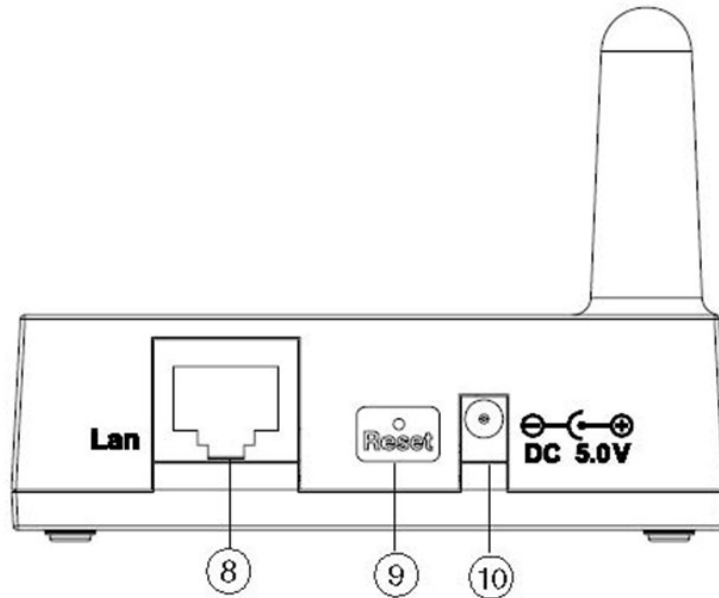

Ref.	Description
8	LAN connection (connect to router)
9	Reset button (use IP Module reset tool or open ended paper clip)
10	AC Power connection

Figure 2

3.4 Finding the ObserverIP from your computer

3.4.1 PC Users

To find the ObserverIP receiver, launch the IP Tools application downloaded here:

[ObserverIp Download Center](#)



The HostIP (your computers IP address) will be displayed. Press the **OK** button to continue.

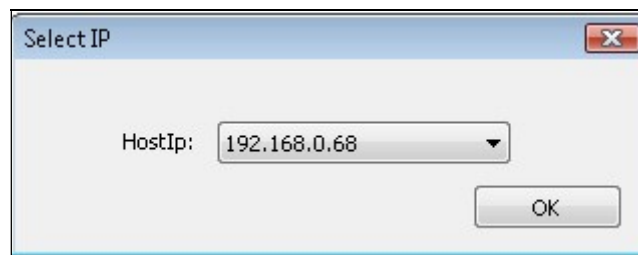

Figure 3

Select the **Search** button to find the ObserverIP on your local area network.

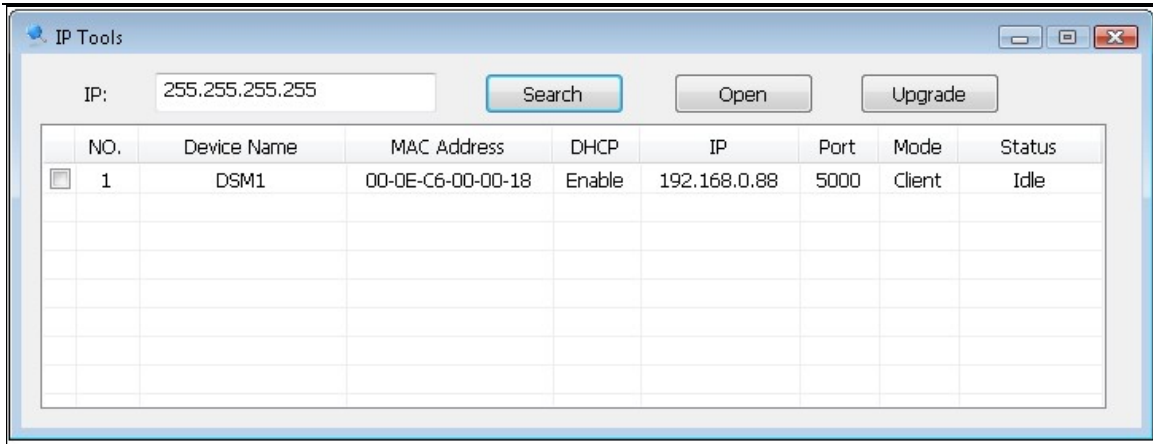

Figure 4

Select the ObserverIP module on your network as shown in Figure 5 (the field will be highlighted) and select the **Open** button (or double click this field) to view the ObserverIP module’s webpage within your browser. Alternately, you can type the IP address in your web browser address bar (example, Figure 6):

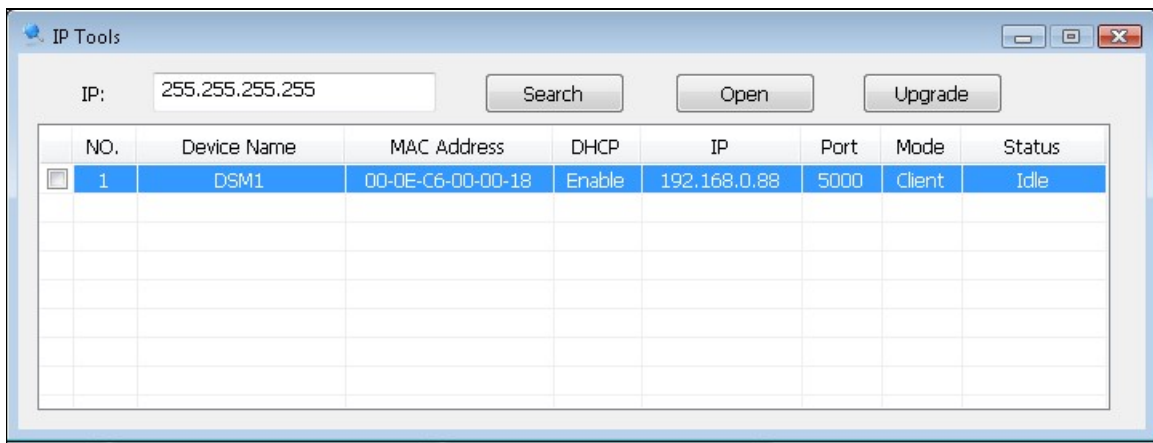

Figure 5

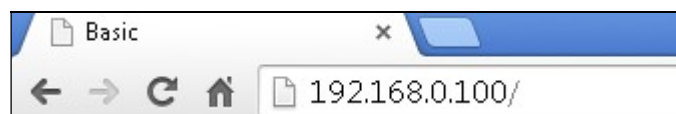

Figure 6

You are now communicating directly to the ObserverIP and can proceed to Section 3.5.

3.4.2 Mac Users

To find the ObserverIP receiver, launch the IP Tools application downloaded here:

[ObserverIp Download Center](#)

The file is compressed as a zip file and must be extracted to run.



Select the **Search** button to find the ObserverIP on your local area network.

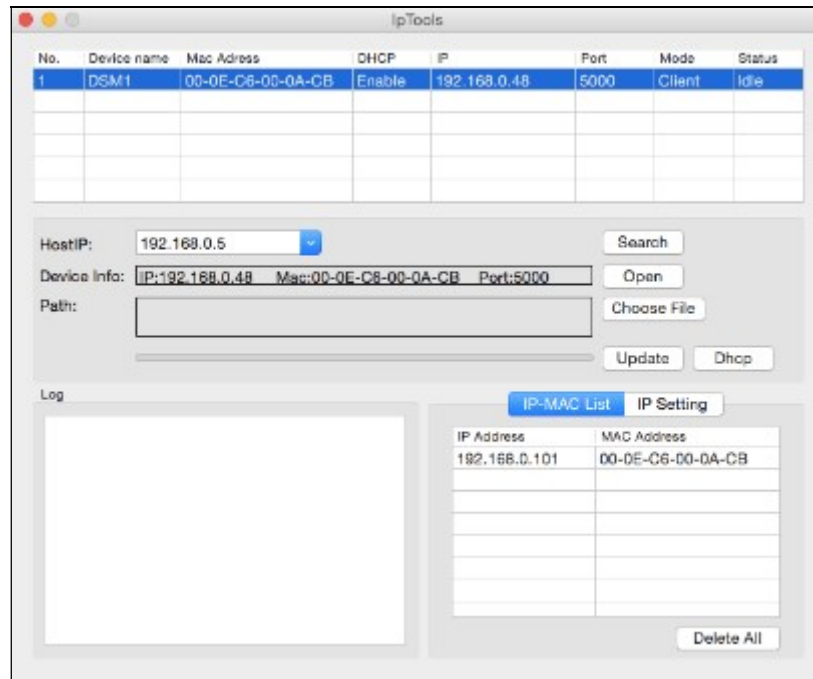

Figure 7

Select the ObserverIP module on your network as shown in Figure 7 (the field will be highlighted) and select the **Open** button (or double click this field) to view the ObserverIP module's webpage within your browser. Alternately, you can type the IP address in your web browser address bar (example, Figure 6):

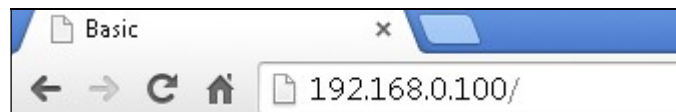

Figure 8

You are now communicating directly to the ObserverIP and can proceed to Section 3.5.

3.4.2 Linux Users

If you use an Apple or Linux operating system, download any commercially available IP scan tool, such as AngryIP Scanner and find the MAC address of the ObserverIP. The MAC address is a unique identifier for internet enabled devices.

The MAC address will be printed on the bottom of the ObserverIP receiver. An example MAC address is 00:0E:C6:00:00:19.

We have included links to free IP Scan Tool applications here:

[ObserverIp Download Center](#)

Figure 9 shows typical scan results. Locate the IP address of the ObserverIP by cross referencing the Mac address. In the example below, the IP address is 192.168.0.105.

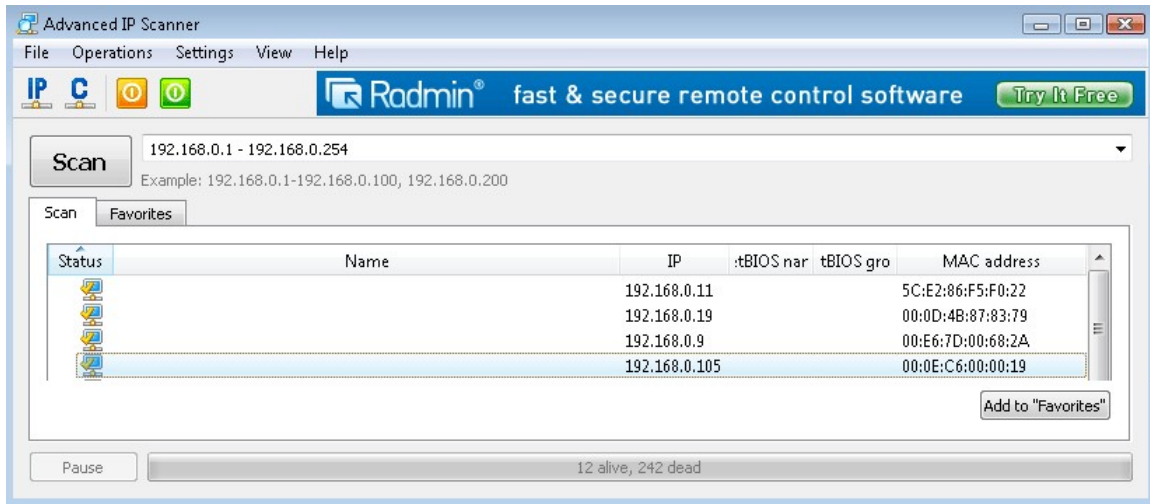

Figure 9

Type the IP address you located from the IP Scan Tool into your web browser (example, Figure 10):

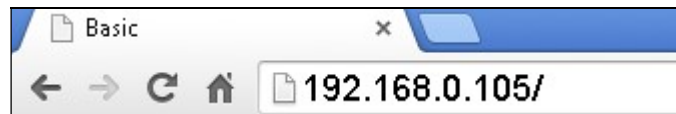

Figure 10

You are now communicating directly to the ObserverIP and can proceed to Section 3.5.

3.5 Local Device Network Settings (optional)

From your web browser, access the ObserverIP from the IP address obtained in the previous section.

Select the **Local Network** tab to program the local network settings. Reference Figure 11:

1. **IP Address.** The default setting is receive automatically (DCHP), **which is recommended.** The network will assign an IP address. To statically assign an IP address, select **Static** from the pull down menu. This will prevent the IP address from changing each time you power up the ObserverIP receiver.
2. **Static IP Address.** If Static is selected as the IP address, enter the IP address you wish to access the ObserverIP module.
3. **Static Subnet Mask.** Default is 255.255.255.0. This should not be changed unless you are familiar with networking and subnet masking.
4. **Static Default Gateway.** This is typically the IP address of your router.
5. **Static DNS Server.** This is your DNS Server setting based on your router connection.
6. **Server Listening Port.** Default is 5000. Enter an integer between 1024 – 65535.

If you made any Static IP Address changes (not recommended), to confirm these changes, select **Apply** and **Reboot**.

Note: If you incorrectly set the static IP settings and can no longer access the ObserverIP, press the reset button on the back of the module.

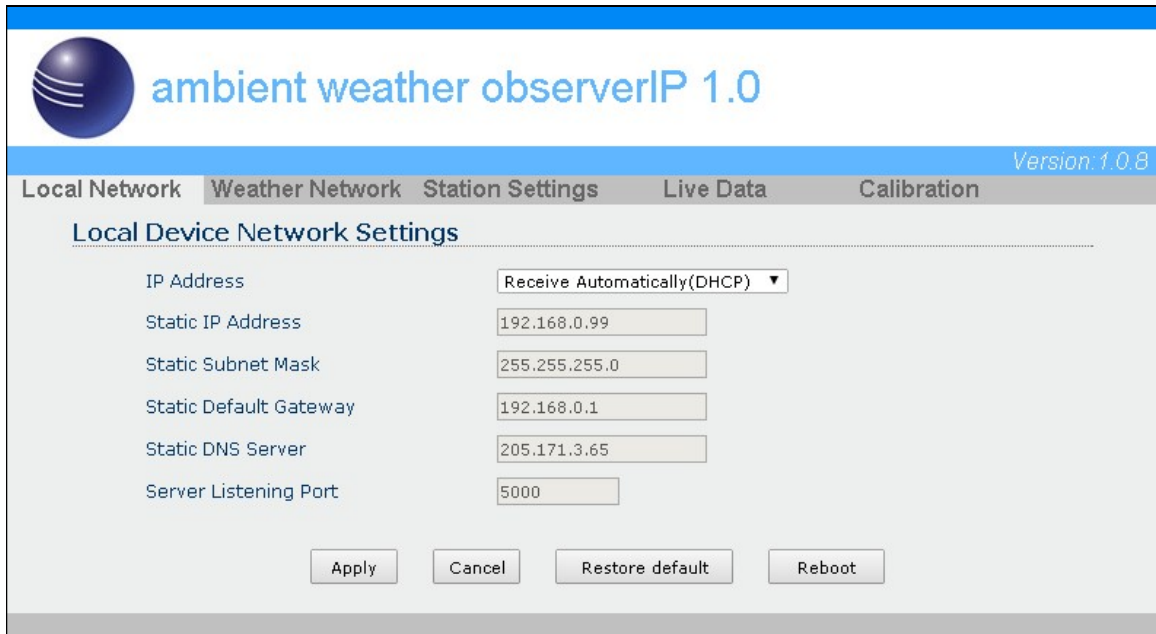

ambient weather observerIP 1.0 Version: 1.0.8

Local Network **Weather Network** Station Settings Live Data Calibration

Local Device Network Settings

IP Address

Static IP Address

Static Subnet Mask

Static Default Gateway

Static DNS Server

Server Listening Port

Apply Cancel Restore default Reboot

Figure 11

3.6 Weather Network Settings

Select the **Weather Network** tab to program the Weather Underground station settings and Ambient Weather Network settings (AmbientWeather.net requires firmware Version 4.0 or greater). Reference Figure 12:

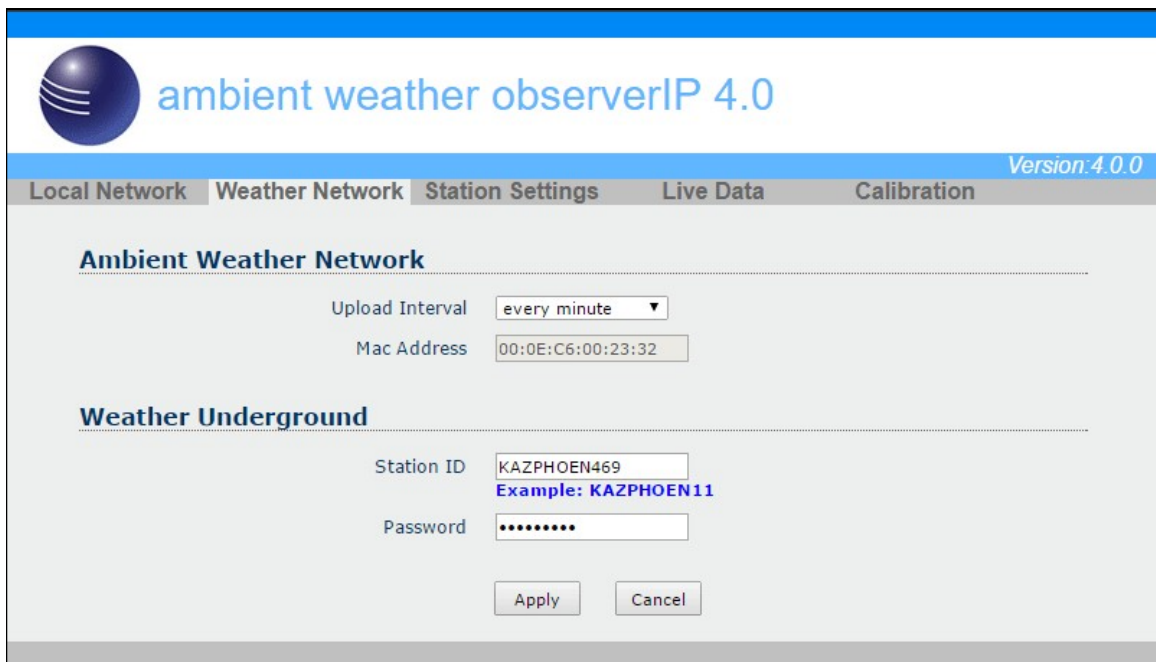

ambient weather observerIP 4.0 Version: 4.0.0

Local Network **Weather Network** Station Settings Live Data Calibration

Ambient Weather Network

Upload Interval

Mac Address

Weather Underground

Station ID
Example: **KAZPHOEN11**

Password

Apply Cancel

Figure 12

3.6.1 WeatherUnderground.com

Enter the Station ID and Station Key obtained from Wunderground.com®. Select the **Apply** button to confirm changes.

3.6.1.1 Creating a WeatherUnderground.com Account

Note: The Weather Underground website is subject to change.

1. Visit Wunderground.com, and select the [Join](#) link in the upper right and corner and create a Free Account.
2. From the menu, Select **More | Add a Weather Station**, or visit: <https://www.wunderground.com/personal-weather-station/signup>
3. Click **Send Validation Email**. Respond to the validation email from Wunderground (it may take a several minutes).
4. Revisit **More | Add a Weather Station**, or visit: <https://www.wunderground.com/personal-weather-station/signup> again and enter all of the information requested.
5. Once registered, you receive a station ID and password. Make a note of this. You will need to enter it into your weather station web interface shown in Figure 12 (Figure 13 is an example and your station ID and password will be different).

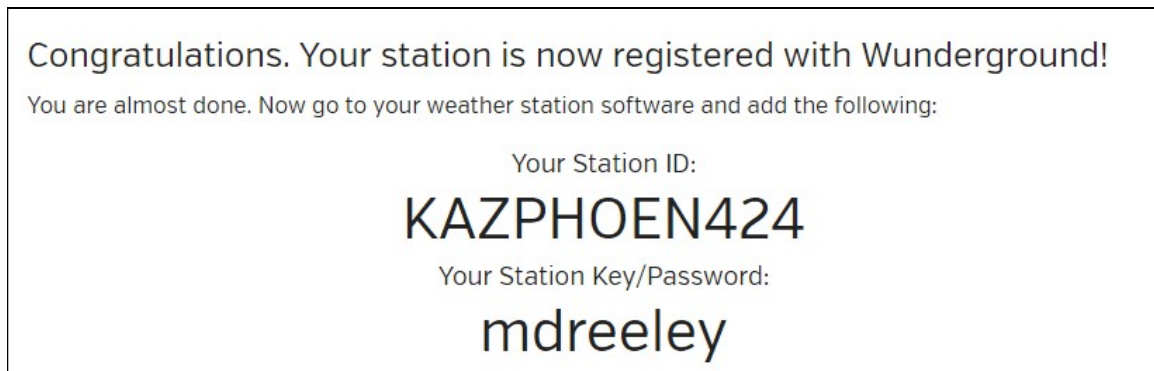

Figure 13

Note: Your station ID will have the form: KSSCCCC###, where K is for USA station (I for international), SS is your state, CCCC is your city and ### is the station number in that city.

In the example above, KAZPHOEN424 is in the USA (K), State of Arizona (AZ), City of Phoenix (PHOEN) and #424.

3.6.1.2 Viewing your Data on Wunderground.com

There are several ways to view your data on Wunderground:

3.6.1.2.1 Web Browser

Visit:

<http://www.wunderground.com/personal-weather-station/dashboard?ID=STATIONID>

where **STATIONID** is your personal station ID (example, KAZSEDON12).

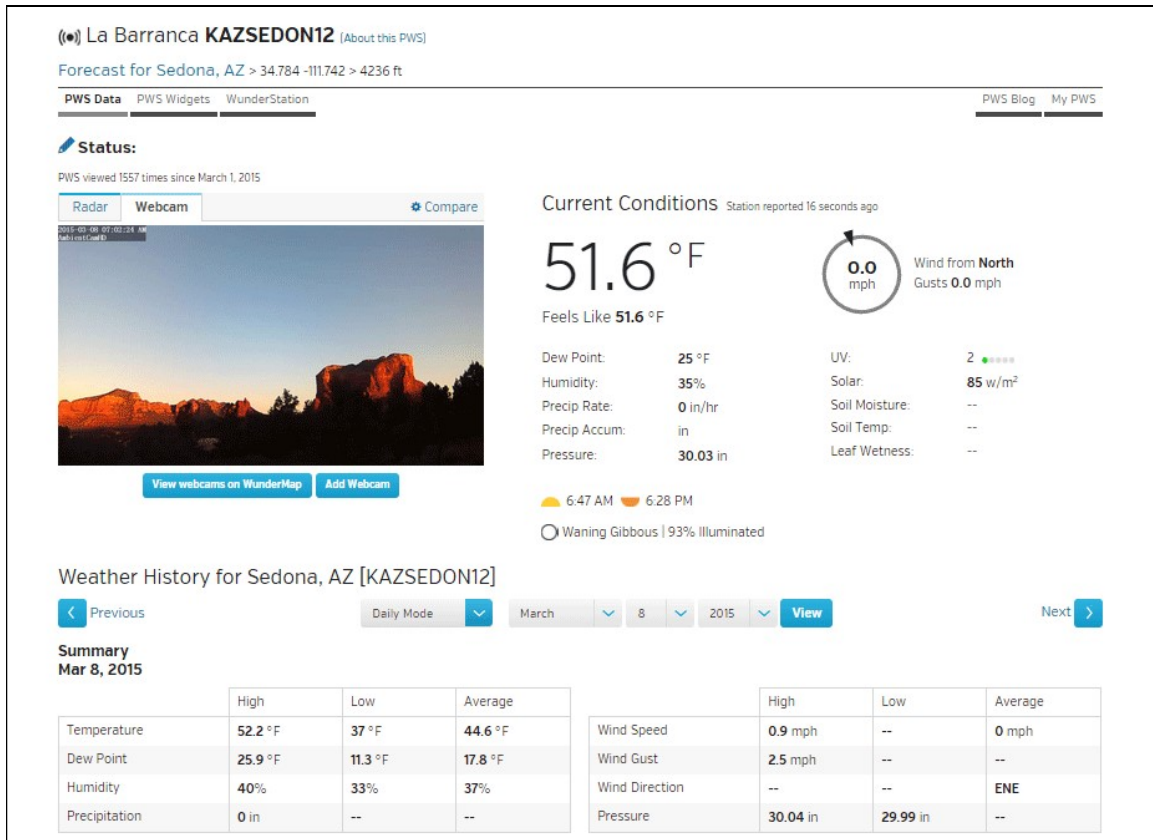

Figure 14

3.6.2 AmbientWeather.net

Reference Figure 12. Enter and update schedule and select **Apply**. Make a note of the MAC address. It will be required when you sign up at AmbientWeather.net.

3.6.2.1 Creating an AmbientWeather.net Account

Visit: www.AmbientWeather.net to create an account and select Add Device, as shown in Figure 15.

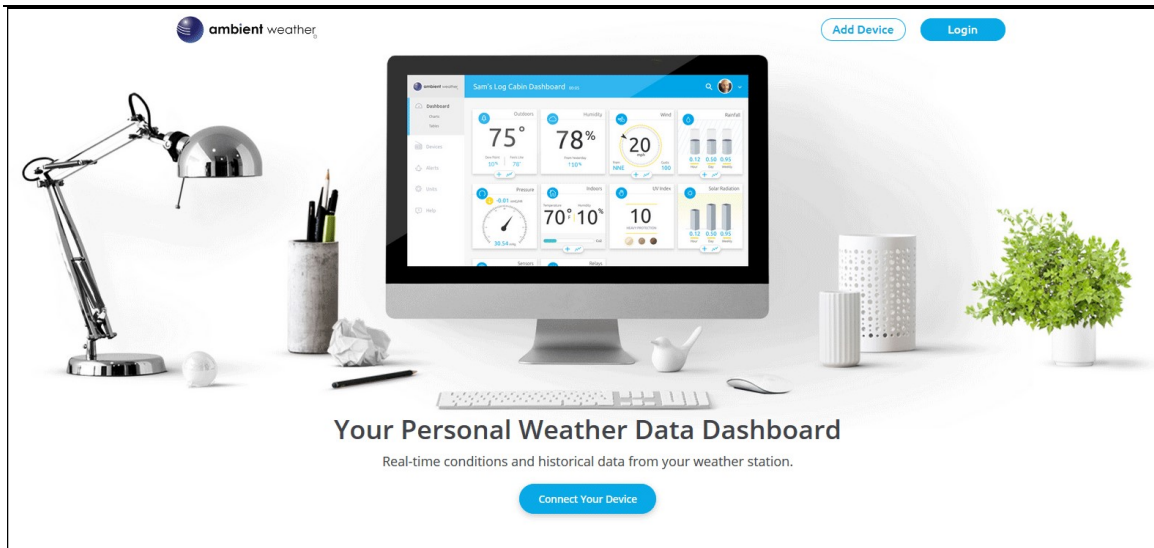
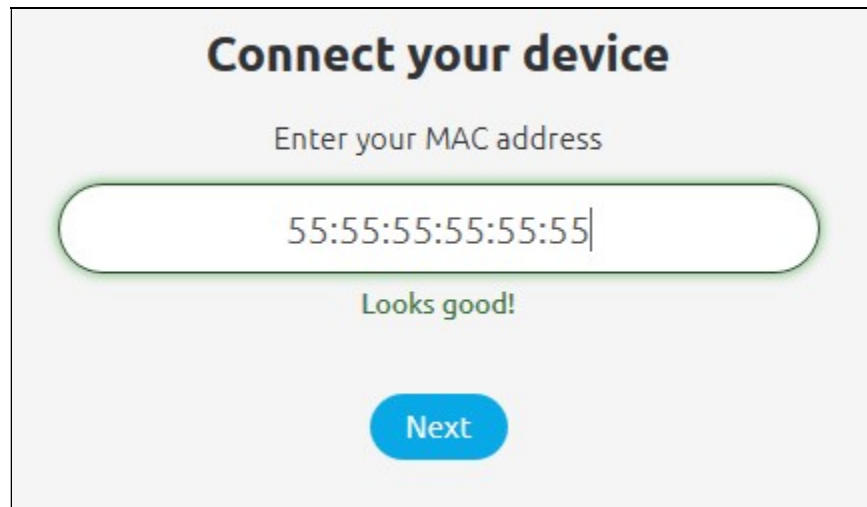

Figure 15

Next, enter the MAC address found on your IP Module Weather Network Panel (Figure 12), as shown in Figure 16. Note that this is an example only and your MAC address will be different.



Connect your device

Enter your MAC address

55:55:55:55:55:55|

Looks good!

Next

Figure 16

Register an account on AmbientWeather.net (email address and password).

Once registered, select the dashboard to view your data, as shown in Figure 17.

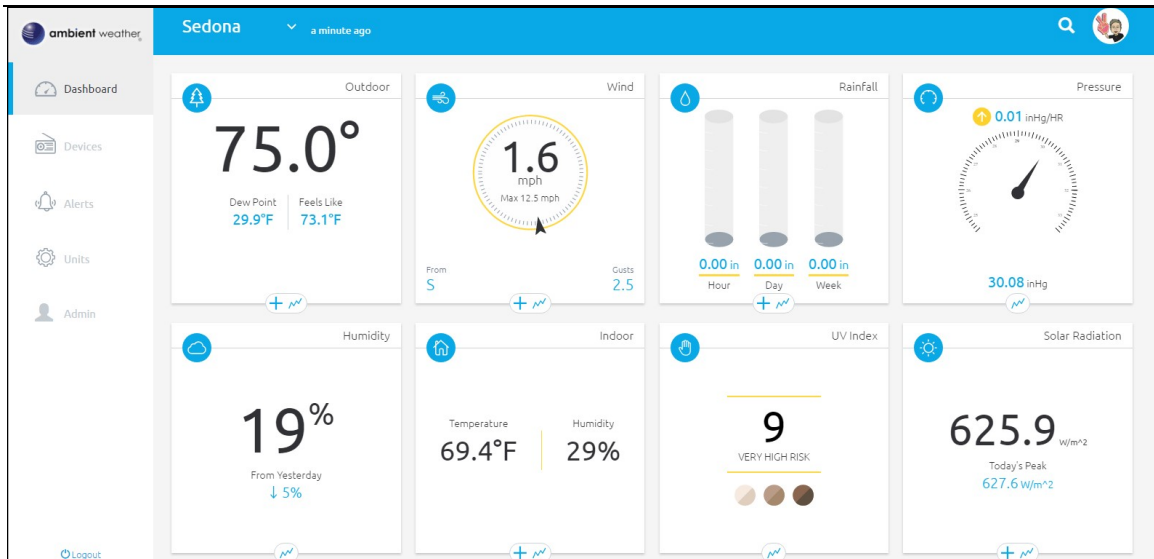

Figure 17

AmbientWeather.net is a responsive design and mobile friendly, so there is no need for a mobile app. Simply open your mobile devices web browser, browse to AmbientWeather.net, and bookmark your dashboard. If you save the bookmark to your desktop, it will automatically save the Ambient Weather icon, as shown in Figure 18.

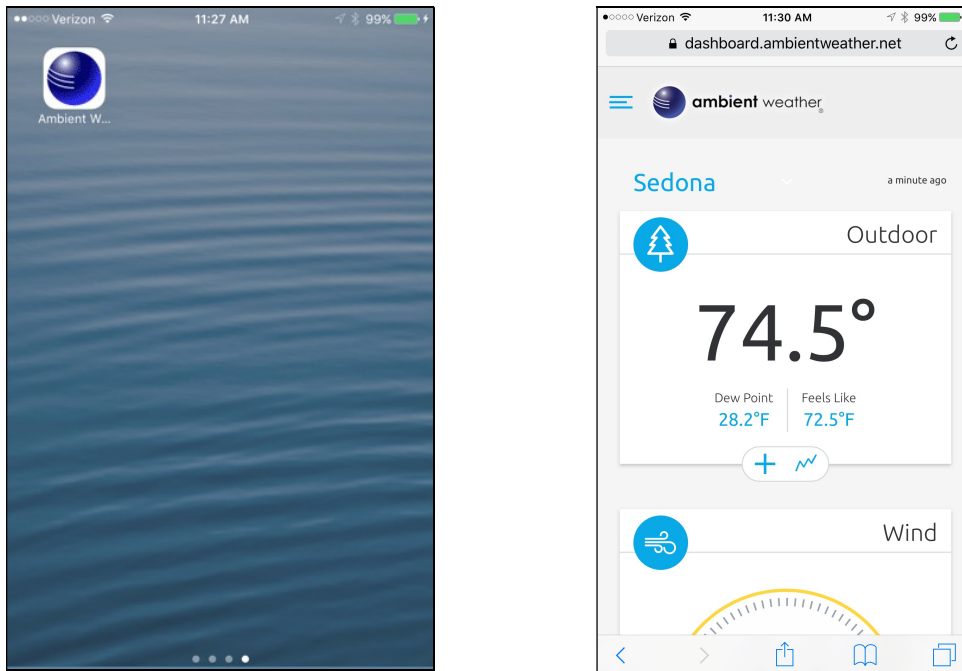

Figure 18

3.6.3 Additional AmbientWeather.net Features

3.6.3.1 IFTTT

The AmbientWeather.net service connects to IFTTT, the platform that allows devices and services to work together seamlessly.

Here are a few things you can do with IFTTT:

- Turn off your Rachio sprinklers when it rains, there is too much wind, or below freezing.
- Close your Hunter blinds when the sun is too intense.
- Close your garage door when it is too windy.
- Blink your hue lights when it starts raining.
- Connect to other web services, such as Gmail, Facebook, Instagram, or Pinterest.

For more information on IFTTT and how it can work for you, visit:

https://ifttt.com/ambient_weather

3.6.3.2 Compatible with Alexa

The Ambient Weather skill provides Ambient Weather personal weather station owners with the ability to get real-time, and past weather information generated by the devices they have set up at AmbientWeather.net.

Enable the skill and get started: say "Alexa, ask Ambient Weather for a weather report.". This will provide you with your outdoor weather report, but you can ask for your indoor weather report as well by saying, "Alexa, ask Ambient Weather about the indoor conditions." You can also ask for a report about a specific day, month or year! Just say "Alexa, ask Ambient Weather about the weather yesterday." or "Alexa, ask Ambient Weather about the weather in May".

For more information and to enable this skill, visit:

<https://www.amazon.com/dp/B074PGCM1D/>

3.6.3.3 Works with Google Assistant

The Ambient Weather Google Assistant app provides Ambient Weather personal weather station owners with the ability to get real-time, and past weather information generated by the devices they have set up at AmbientWeather.net

Link your account to get started: say 'hey google, Ambient Weather... weather report.' This will provide you with your outdoor weather report. You can ask for your indoor weather report as well by saying, 'indoor conditions'.

You can also link the Ambient Weather app by downloading the Google Assistant.

Here are some sample commands:

- Weather Report
- Outdoor conditions
- Indoor conditions
- Yesterdays weather
- Conditions for October 15, 2017
- Conditions for September 2017
- Conditions for 2016

For more information and to enable this app, visit:

<https://assistant.google.com/services/a/id/668e6f3369f27209/>

3.7 Station Settings

Select **Apply** to confirm any of the changes in this section.

3.7.1 Weather Station Settings

Weather Station Model Number: Enter your weather station model number.

3.7.2 Time Zone Setting

Enter your local time zone and daylight Savings Time.

The following table provides times zones throughout the world. Locations in the eastern hemisphere are positive, and locations in the western hemisphere are negative.

Hours from GMT	Time Zone	Cities
-12	IDLW: International Date Line West	---
-11	NT: Nome	Nome, AK
-10	AHST: Alaska-Hawaii Standard CAT: Central Alaska HST: Hawaii Standard	Honolulu, HI
-9	YST: Yukon Standard	Yukon Territory
-8	PST: Pacific Standard	Los Angeles, CA, USA
-7	MST: Mountain Standard	Denver, CO, USA
-6	CST: Central Standard	Chicago, IL, USA
-5	EST: Eastern Standard	New York, NY, USA
-4	AST: Atlantic Standard	Caracas
-3	---	São Paulo, Brazil
-2	AT: Azores	Azores, Cape Verde Islands
-1	WAT: West Africa	---
0	GMT: Greenwich Mean WET: Western European	London, England
1	CET: Central European	Paris, France
2	EET: Eastern European	Athens, Greece
3	BT: Baghdad	Moscow, Russia
4	---	Abu Dhabi, UAE
5	---	Tashkent
6	---	Astana
7	---	Bangkok
8	CCT: China Coast	Beijing
9	JST: Japan Standard	Tokyo
10	GST: Guam Standard	Sydney
11	---	Magadan
12	IDLE: International Date Line East NZST: New Zealand Standard	Wellington, New Zealand

3.7.3 Daylight Savings Time

Enter **off** if you live in Hawaii or Arizona, where DST is not observed. Enter **on** if you live anywhere else, even if you are currently observing standard time.

3.7.4 Units of Measure

Enter your preferred units of measure for each parameter.

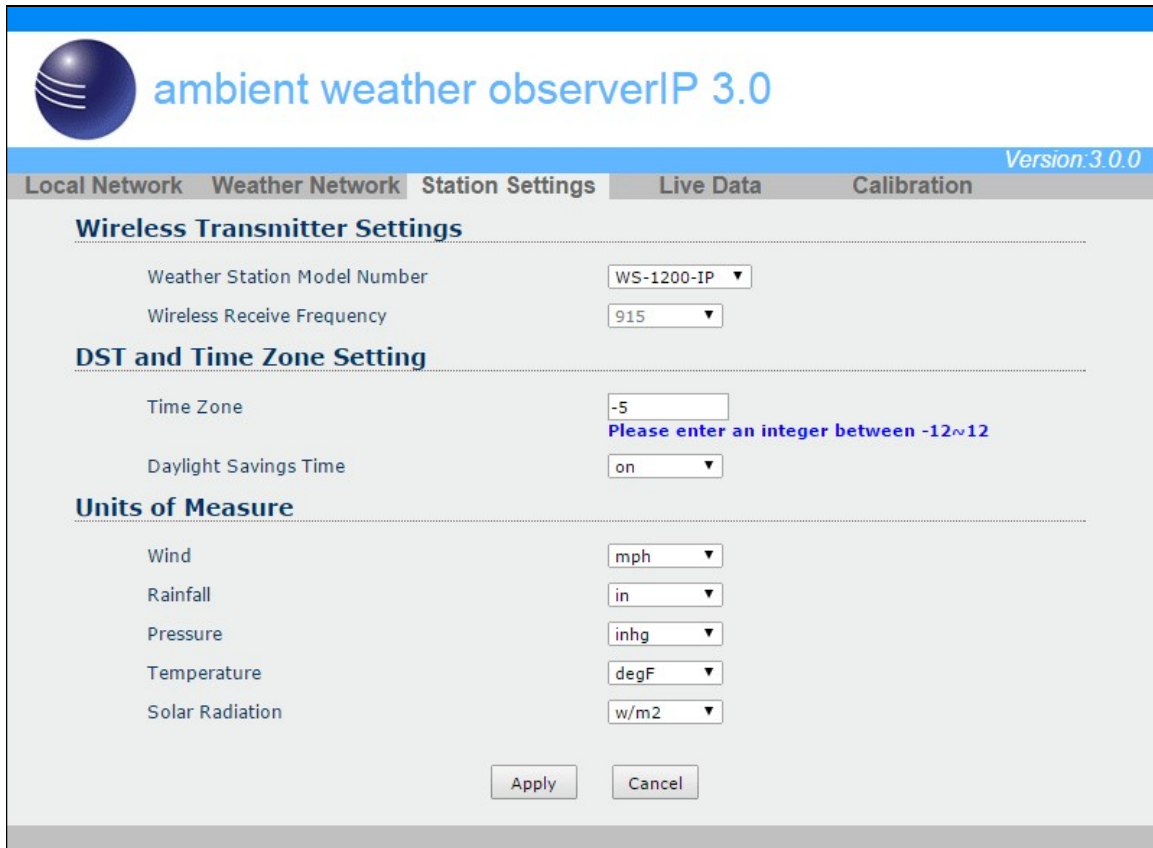

The screenshot shows the 'ambient weather observerIP 3.0' web interface. The 'Station Settings' tab is selected. Under the 'Units of Measure' section, the following settings are visible:

- Weather Station Model Number: WS-1200-IP
- Wireless Receive Frequency: 915
- Time Zone: -5 (with a note: Please enter an integer between -12~12)
- Daylight Savings Time: on
- Wind: mph
- Rainfall: in
- Pressure: inhg
- Temperature: degF
- Solar Radiation: w/m2

Buttons for 'Apply' and 'Cancel' are located at the bottom of the settings area.

Figure 19

3.8 Live Data

Select the **Live Data** tab to view your live data from the weather station. To freeze the live data updates, select the **Stop Refresh** button.

3.8.1 Reset and Change Rain Totals

During the installation of your weather station, you may report false rain do to vibration of the tipping mechanism. To reset the rain to 0.00, select the **Rain Reset** button as shown in Figure 20, or enter the Daily, Weekly, Yearly, Monthly and Yearly rain totals in the appropriate fields, and select **Apply**.

During rain gauge cleaning, the tipping mechanism may record false rain. Before rain gauge cleaning, record the rain totals before and after the cleaning procedure, then correct the daily, weekly, monthly and yearly totals.

ambient weather observerIP 4.0
Version: 4.0.0

Local Network
Weather Network
Station Settings
Live Data
Calibration

Live Data

Receiver Time:	14:36 04/20/2017	
Indoor Sensor ID and Battery	0x4b	Normal
Outdoor Sensor ID and Battery	0xfb	Normal
Outdoor2 Sensor ID and Battery	0x--	--
Indoor Temperature	76.6	
Indoor Humidity	23	
Absolute Pressure	28.59	
Relative Pressure	29.89	
Outdoor Temperature	90.3	
Outdoor Humidity	19	
Wind Direction	198	
Wind Speed	0.0	
Wind Gust	0.0	
Max Daily Gust	4.9	
Solar Radiation	798.76	
UV	2384	
UVI	6	
Hourly Rain Rate	0.00	
Daily Rain	0.00	
Weekly Rain	0.00	
Monthly Rain	0.00	
Yearly Rain	0.00	

Apply
Cancel

Rain Reset

Refresh

Stop Refresh

Figure 20

3.9 Calibration

Select the Calibration tab to view your calibration data from the weather station. Select the **Apply** button to confirm changes.

Calibration of most parameters is not required, with the exception of Relative Pressure, which must be calibrated to sea-level to account for altitude effects. For more information on sea-level pressure calibration, please reference note (3) below.

3.9.1 Relative Barometric Pressure Calibration Example

The following is an example of calibrating the relative pressure. Your results will vary.

1. The local relative pressure from TV, the newspaper or the internet for the official station in your area is 30.12 inHg.
2. From the Live Data panel, your absolute pressure (measured, and not corrected to sea-level) reads 28.90 inHg.
3. Reference Figure 21. Enter the following offset in the Calibration panel for Relative Pressure Offset:

$$\text{Relative Pressure Offset} = 30.12 - 28.90 = 1.22$$

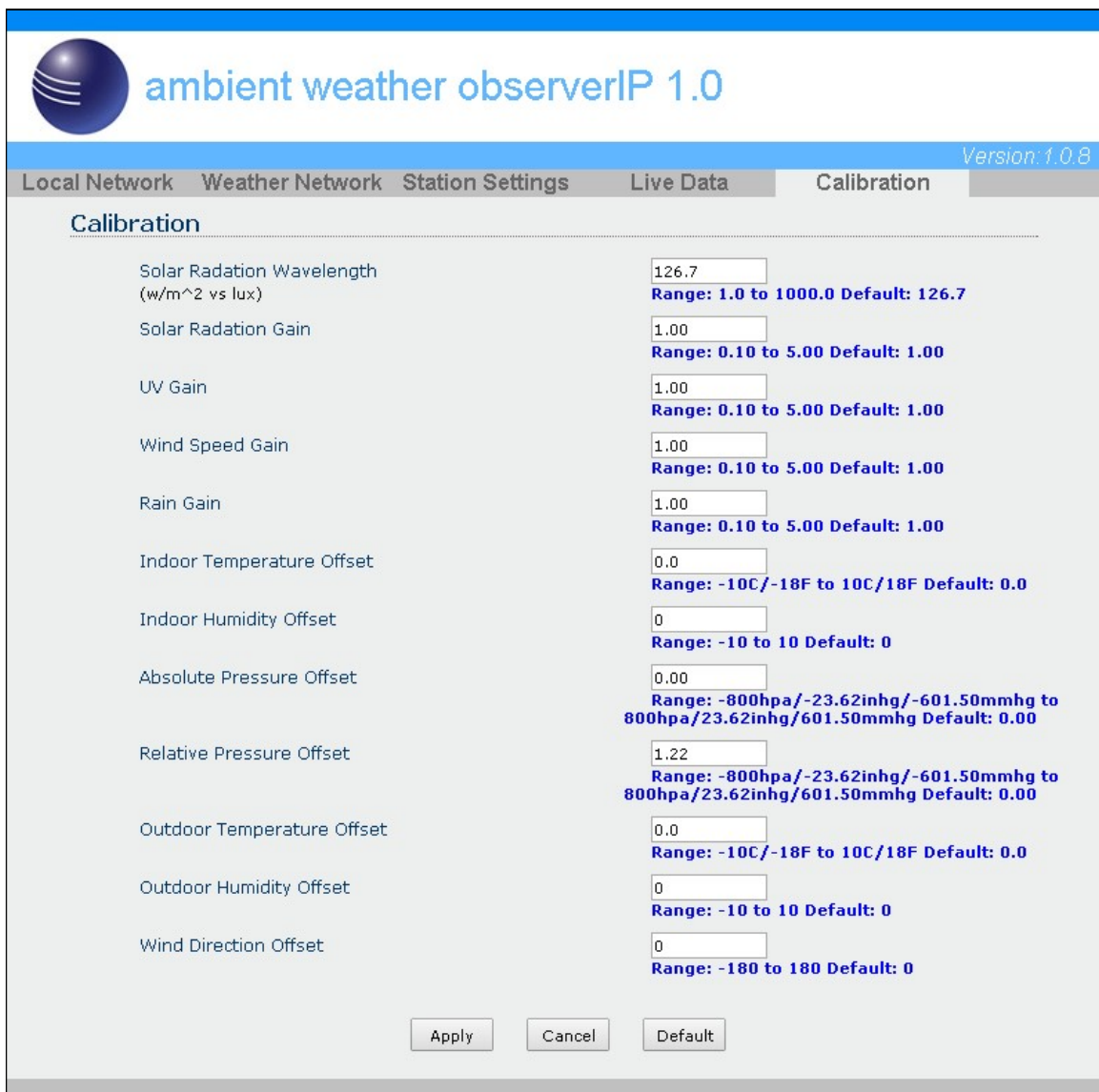

The screenshot shows the 'Calibration' panel of the 'ambient weather observerIP 1.0' software. The 'Relative Pressure Offset' is set to 1.22. The panel includes various other calibration settings such as Solar Radiation Wavelength, UV Gain, Wind Speed Gain, and Indoor/Outdoor Temperature and Humidity Offsets. The 'Apply', 'Cancel', and 'Default' buttons are visible at the bottom.

Parameter	Value	Range / Default
Solar Radiation Wavelength (w/m ² vs lux)	126.7	Range: 1.0 to 1000.0 Default: 126.7
Solar Radiation Gain	1.00	Range: 0.10 to 5.00 Default: 1.00
UV Gain	1.00	Range: 0.10 to 5.00 Default: 1.00
Wind Speed Gain	1.00	Range: 0.10 to 5.00 Default: 1.00
Rain Gain	1.00	Range: 0.10 to 5.00 Default: 1.00
Indoor Temperature Offset	0.0	Range: -10C/-18F to 10C/18F Default: 0.0
Indoor Humidity Offset	0	Range: -10 to 10 Default: 0
Absolute Pressure Offset	0.00	Range: -800hpa/-23.62inhg/-601.50mmhg to 800hpa/23.62inhg/601.50mmhg Default: 0.00
Relative Pressure Offset	1.22	Range: -800hpa/-23.62inhg/-601.50mmhg to 800hpa/23.62inhg/601.50mmhg Default: 0.00
Outdoor Temperature Offset	0.0	Range: -10C/-18F to 10C/18F Default: 0.0
Outdoor Humidity Offset	0	Range: -10 to 10 Default: 0
Wind Direction Offset	0	Range: -180 to 180 Default: 0

Figure 21

Parameter	Type of Calibration	Default	Typical Calibration Source
Temperature	Offset	Current Value	Red Spirit or Mercury Thermometer (1)
Humidity	Offset	Current Value	Sling Psychrometer (2)
ABS Barometer	Offset	Current Value	Calibrated laboratory grade barometer
REL Barometer	Offset	Current Value	Local airport (3)
Wind Direction	Offset	Current Value	GPS, Compass (4)
Solar Radiation	Gain	1.00	Calibrated laboratory grade solar radiation sensor
l w/m ²	Gain	126.7 lux	Solar radiation conversion from lux to w/m ² for wavelength correction (5)
Wind	Gain	1.00	Calibrated laboratory grade wind meter (6)
Rain	Gain	1.00	Sight glass rain gauge with an aperture of at least 4" (7)
Daily Rain	Offset	Current Value	Apply an offset if the weather station was not operating for the entire day.
Weekly Rain	Offset	Current Value	Apply an offset if the weather station was not operating for the entire week.
Monthly Rain	Offset	Current Value	Apply an offset if the weather station was not operating for the entire month.
Yearly Rain	Offset	Current Value	Apply an offset if the weather station was not operating for the entire year.

- (1) Temperature errors can occur when a sensor is placed too close to a heat source (such as a building structure, the ground or trees).

To calibrate temperature, we recommend a mercury or red spirit (fluid) thermometer. Bi-metal (dial) and digital thermometers (from other weather stations) are not a good source and have their own margin of error. Using a local weather station in your area is also a poor source due to changes in location, timing (airport weather stations are only updated once per hour) and possible calibration errors (many official weather stations are not properly installed and calibrated).

Place the sensor in a shaded, controlled environment next to the fluid thermometer, and allow the sensor to stabilize for 48 hours. Compare this temperature to the fluid thermometer and adjust the ObserverIP receiver to match the fluid thermometer.

- (2) Humidity is a difficult parameter to measure electronically and drifts over time due to contamination. In addition, location has an adverse affect on humidity readings (installation over dirt vs. lawn for example).

Official stations recalibrate or replace humidity sensors on a yearly basis. Due to manufacturing tolerances, the humidity is accurate to $\pm 5\%$. To improve this accuracy, the

indoor and outdoor humidity can be calibrated using an accurate source, such as a sling psychrometer.

- (3) The ObserverIP receiver displays two different pressures: absolute (measured) and relative (corrected to sea-level).

To compare pressure conditions from one location to another, meteorologists correct pressure to sea-level conditions. Because the air pressure decreases as you rise in altitude, the sea-level corrected pressure (the pressure your location would be at if located at sea-level) is generally higher than your measured pressure.

Thus, your absolute pressure may read 28.62 inHg (969 mb) at an altitude of 1000 feet (305 m), but the relative pressure is 30.00 inHg (1016 mb).

The standard sea-level pressure is 29.92 in Hg (1013 mb). This is the average sea-level pressure around the world. Relative pressure measurements greater than 29.92 inHg (1013 mb) are considered high pressure and relative pressure measurements less than 29.92 inHg are considered low pressure.

To determine the relative pressure for your location, locate an official reporting station near you (the internet is the best source for real time barometer conditions, such as Weather.com or Wunderground.com), and set your weather station to match the official reporting station.

- (4) Only use this if you improperly installed the weather station sensor array, and did not point the direction reference to true north.
- (5) The default conversion factor based on the wavelength for bright sunlight is 126.7 lux / w/m². This variable can be adjusted by photovoltaic experts based on the light wavelength of interest, but for most weather station owners, is accurate for typical applications, such as calculating evapotranspiration and solar panel efficiency.
- (6) Wind speed is the most sensitive to installation constraints. The rule of thumb for properly installing a wind speed sensor is 4 x the distance of the tallest obstruction. For example, if your house is 20' tall and you mount the sensor on a 5' pole:

$$\text{Distance} = 4 \times (20 - 5)' = 60'$$

Many installations are not perfect and installing the weather station on a roof can be difficult. Thus, you can calibrate for this error with a wind speed multiplier.

In addition to the installation challenges, wind cup bearings (moving parts) wear over time.

Without a calibrated source, wind speed can be difficult to measure. We recommend using a calibrated wind meter (available from Ambient Weather) and a constant speed, high speed fan.

- (7) The rain collector is calibrated at the factory based on the funnel diameter. The bucket tips every 0.01" of rain (referred to as resolution). The accumulated rainfall can be compared to a sight glass rain gauge with an aperture of at least 4". The following is a link to an accurate sight glass rain gauge:

<http://www.ambientweather.com/stpraga.html>

Make sure you periodically clean the rain gauge funnel.

 **Note:** The purpose of calibration is to fine tune or correct for any sensor error associated with the devices margin of error. Errors can occur due to electronic variation (example, the temperature sensor is a resistive thermal device or RTD, the humidity sensor is a capacitance device), mechanical variation, or degradation (wearing of moving parts, contamination of sensors).

Calibration is only useful if you have a known calibrated source you can compare it against, and is optional. This section discusses practices, procedures and sources for sensor calibration to reduce manufacturing and degradation errors. Do not compare your readings obtained from sources such as the internet, radio, television or newspapers. The purpose of your weather station is to measure conditions of your surroundings, which vary significantly from location to location.

3.10 Adding Additional Sensors

The ObserverIP module supports up to 8 additional thermo-hygrometer sensors (Model WH31B). Place the sensors in and around your home, and monitor on AmbientWeather.net.

The data is automatically passed from the ObserverIP module to AmbientWeather.net based on the channel number.

The channels cannot be calibrated or viewed on the ObserverIP module. The data is transmitted directly to AmbientWeather.net for viewing online.

 **Note:** You must be running Firmware Version 4.4.5 or greater. To determine which firmware version you are running, visit this Help Guide:

<https://ambientweather.net/help/how-do-i-update-the-firmware-for-the-observerip-module/>

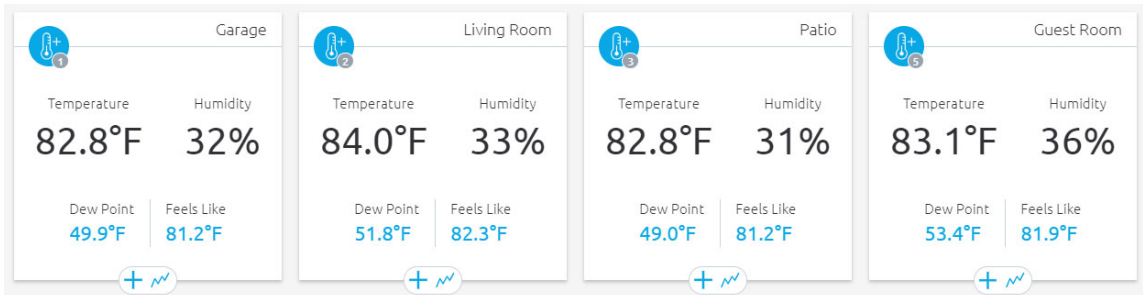



Figure 22

3.10.1 Indoor/Outdoor Thermo-Hygrometer, 8 Channel (optional, Model WH31B)

 **Note:** Do not use rechargeable batteries. We recommend fresh alkaline batteries for outdoor temperature ranges between -4 °F and 140 °F and fresh lithium batteries for outdoor temperature ranges between -40 °F and 140 °F.

1. Remove the battery door on the back of the transmitter(s) by sliding down the battery door, as shown in Figure 23 .

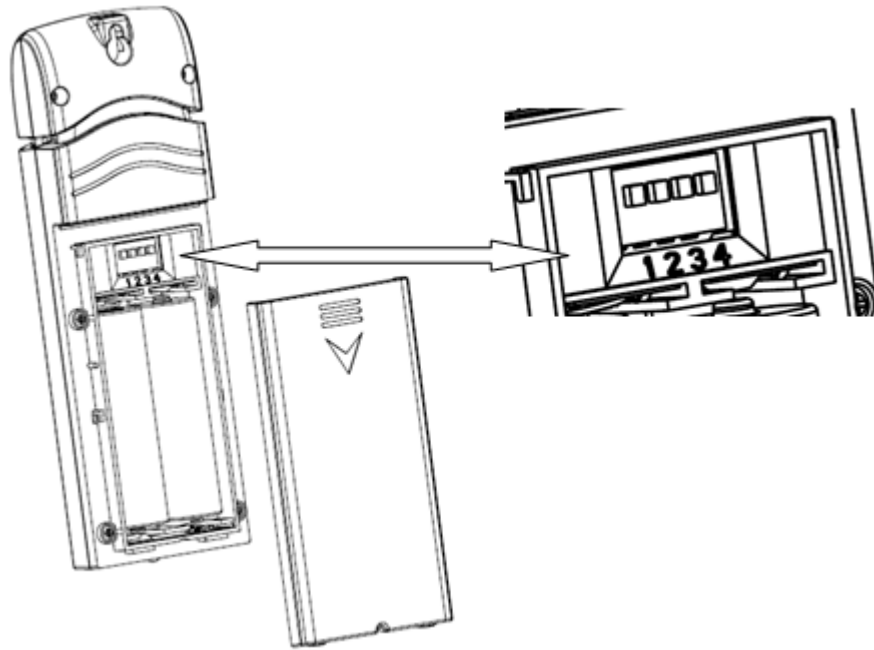

Figure 23

2. **BEFORE** inserting the batteries, locate the dip switches on the inside cover of the lid of the transmitter.
3. **Channel Number:** The ObserverIP supports up to eight transmitters. To set each channel number (the default is Channel 1), change Dip Switches 1, 2 and 3, as referenced in Figure 24.
4. **Temperature Units of Measure:** To change the transmitter display units of measure ($^{\circ}\text{F}$ vs. $^{\circ}\text{C}$), change Dip Switch 4, as referenced in Figure 24.

Switch in down position. Switch in up position.

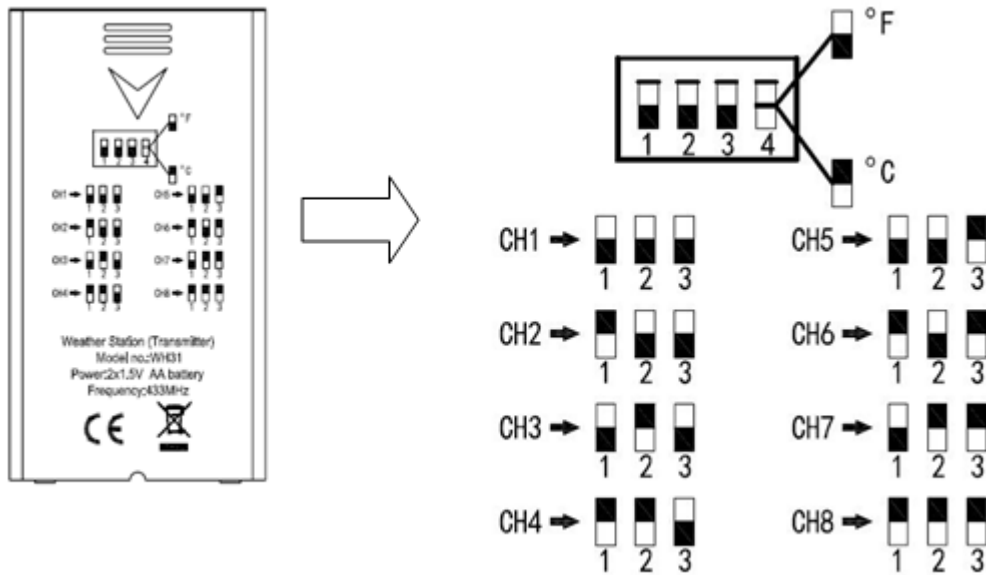

Figure 24

5. Insert two AA batteries.
6. Verify the correct channel number (CH) and temperature units of measure (°F vs. °C) are on the display, as shown in Figure 25.

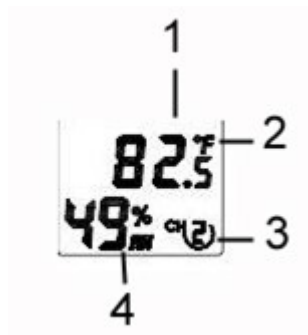

Figure 25

- (1) temperature
 - (2) temperature units (°F vs. °C)
 - (3) channel number
 - (4) relative humidity
7. Close the battery door.
 8. Repeat for the additional remote transmitters, verifying each remote is on a different channel.

3.10.2 Sensor Placement

It is recommended you mount the remote sensor outside on a north facing wall, in a shaded area, at a height at or above the receiver. If a north facing wall is not possible, choose a shaded area, under an eave.

Direct sunlight and radiant heat sources will result in inaccurate temperature readings. Although the sensor is weatherproof, it is best to mount in a well-protected area, such as an eave.

1. Use a screw or nail to affix the remote sensor to the wall, as shown in Figure 6.
2. Hang the remote sensor up on string, as shown in Figure 7.

 **Note:** Make sure the sensor is mounted vertically and not lying down on a flat surface. This will insure optimum reception. Wireless signals are impacted by distance, interference (other weather stations, wireless phones, wireless routers, TVs and computer monitors), and transmission barriers, such as walls. In general, wireless signals will not penetrate solid metal and earth (down a hill, for example).

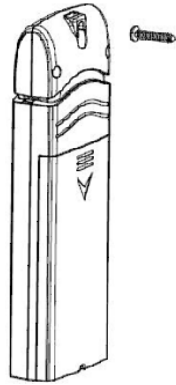

Figure 26

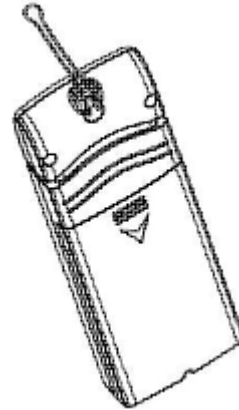

Figure 27

4. Updating Firmware

You must own a PC or Mac to update the firmware. Sorry, Linux products are currently not supported. Ambient Weather will update your ObserverIP at no cost (appropriate shipping charges will apply).

4.1 PC Users

1. Download the latest version of IPTools and firmware at:

[ObserverIp Download Center](#)

2. **Important Note: Close all of other applications while running the firmware update. This will insure the upgrade process will not be interrupted. Make sure your PC and ObserverIP are connected to the same router prior to upgrading the firmware.**
3. Launch the IP Tools application as referenced in Section 3.4.1, and locate the ObserverIP on your network. Reference Figure 28. Select the Upgrade button to begin the firmware upgrade. As shown in this figure, the IP address of the ObserverIP is 192.168.0.7. Make a note of your IP address (your results will vary).

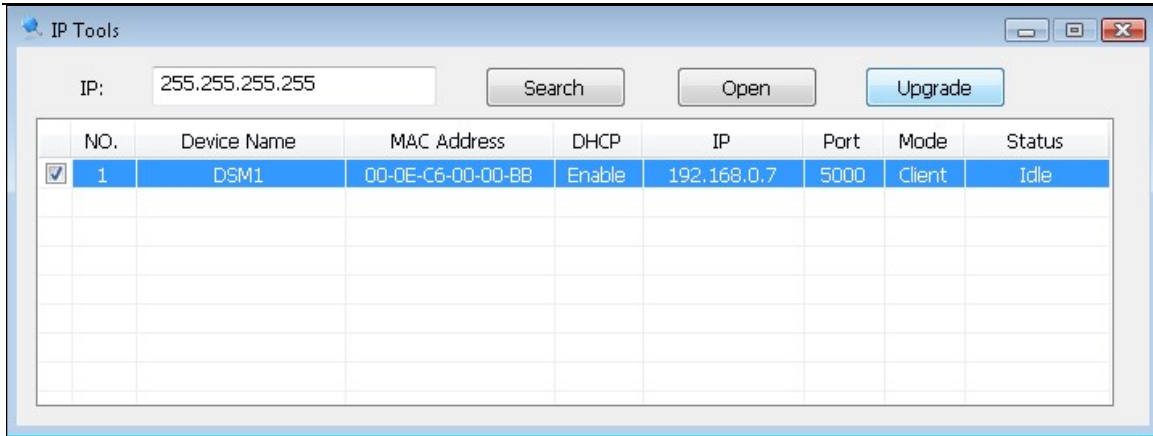

Figure 28

4. Reference Figure 29. Select the **Select File** button, and browse to the location of the file you downloaded in Step 1.

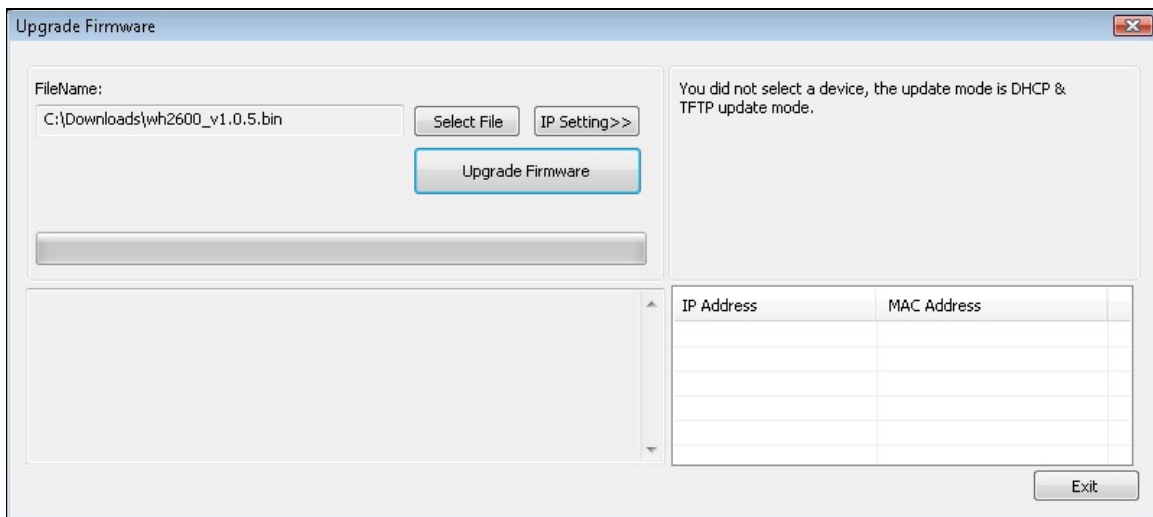

Figure 29

5. Select the **Upgrade Firmware** button. Reference Figure 30. The dialog box will display **Received a Read Request** from the ObserverIP module. A green progress bar will provide you with the upgrade status.

DO NOT OPERATE THE MOUSE OR KEYBOARD WHEN UPGRADING to prevent interruption of the upgrade.

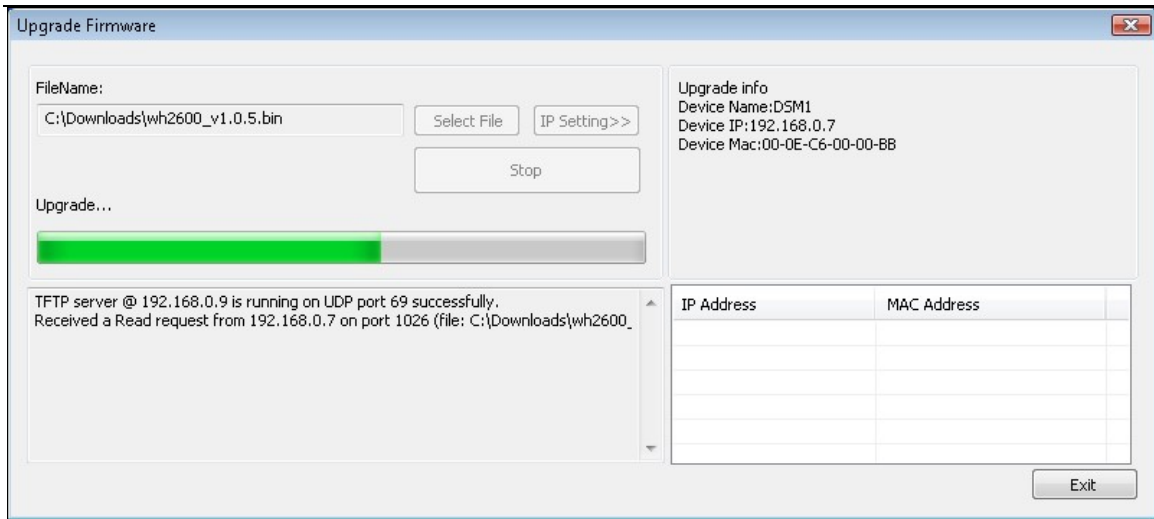

Figure 30

- Once the firmware upgrade is complete, the dialog box will display **Read session is completed successfully**, as shown in Figure 31.

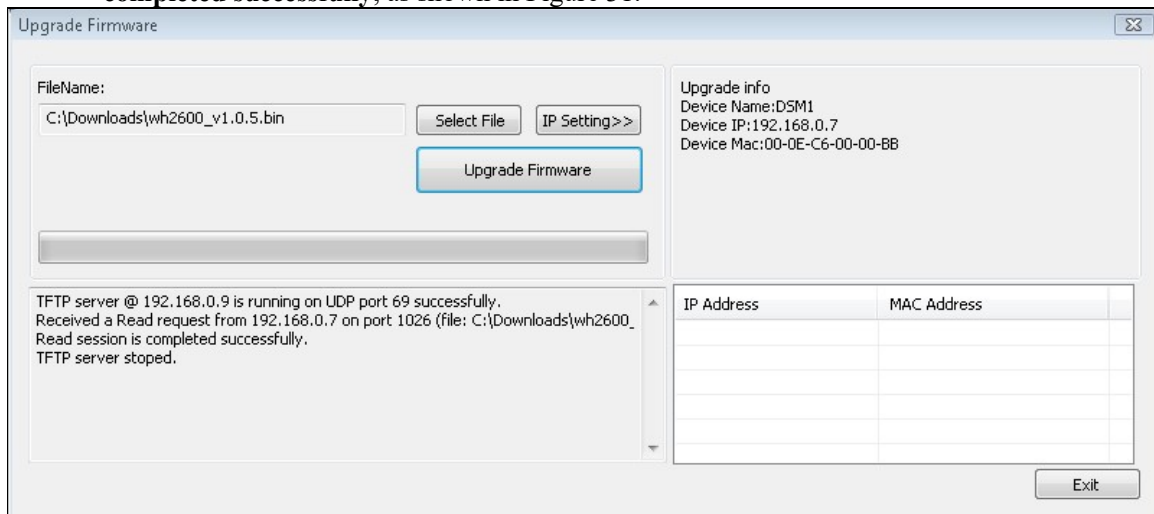

Figure 31

- Wait about one minute for the ObserverIP module to reboot. You can now **Exit** the upgrade window, and access the module again, as referenced in Section 3.4.

You may be required to enter some settings, so check all of the panels for completeness.

4.2 Mac Users

- Download the latest version of firmware at: [ObserverIp Download Center](#)

Important Note: Close all of other applications while running the firmware update. This will insure the upgrade process will not be interrupted. Make sure your PC and OberverIP are connected to the same router prior to upgrading the firmware.

2. Launch the IP Tools application as referenced in Section 3.4.2, and locate the ObserverIP on your network. Reference Figure 28.

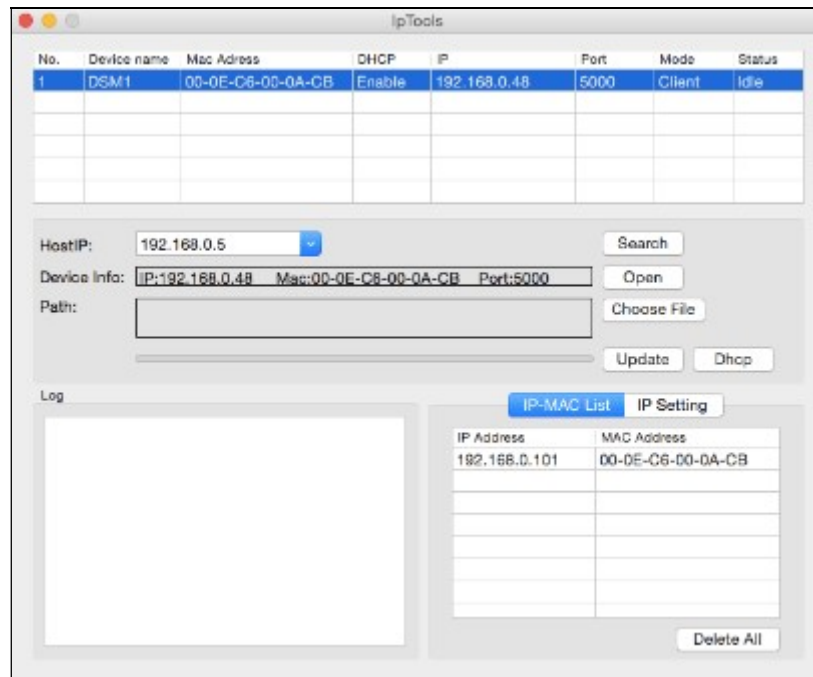

Figure 32

1. Reference Figure 29. Select the **Choose File** button, and browse to the location of the file you downloaded in Step 1.

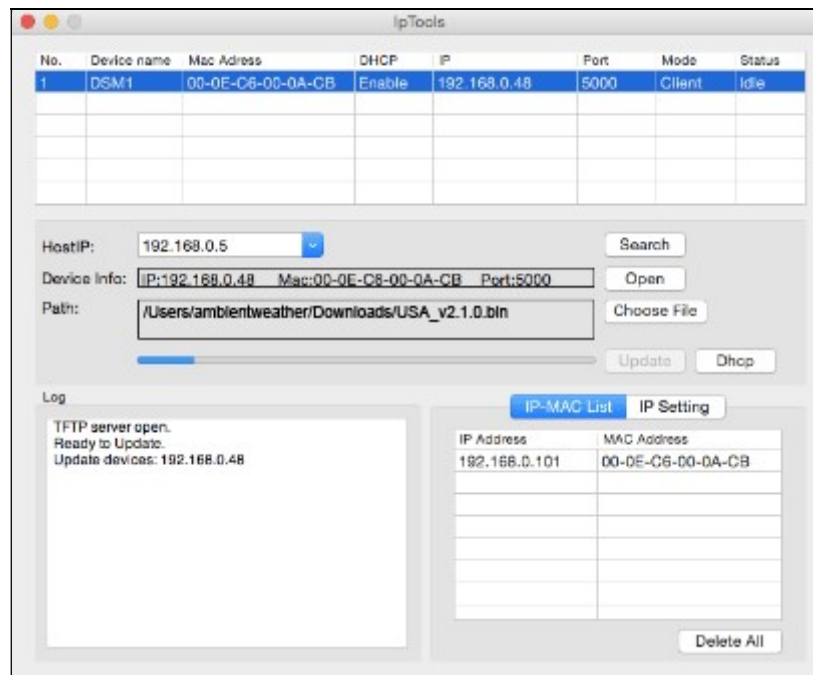

Figure 33

2. Select the **Update** button. Reference Figure 30. The dialog box will display **Ready to Update** from the ObserverIP module. A progress bar will provide you with the upgrade status.

DO NOT OPERATE THE MOUSE OR KEYBOARD WHEN UPGRADING to prevent interruption of the upgrade.

3. Once the firmware upgrade is complete, the dialog box will display **Update Success**.
4. Wait about one minute for the ObserverIP module to reboot. You can now **Exit** the upgrade window, and access the module again, as referenced in Section 3.4.

You may be required to enter some settings, so check all of the panels for completeness.

If the update is not successful, restart IP Tools and try again. You do not have to locate the ObserverIP module on the network as it will broadcast the request to all devices on your network.

5. Glossary of Terms

Term	Definition
Absolute Barometric Pressure	Absolute pressure is the measured atmospheric pressure and is a function of altitude, and to a lesser extent, changes in weather conditions. Absolute pressure is not corrected to sea-level conditions. <i>Refer to Relative Barometric Pressure.</i>
Accuracy	Accuracy is defined as the ability of a measurement to match the actual value of the quantity being measured.
Barometer	A barometer is an instrument used to measure atmospheric pressure.
Calibration	Calibration is a comparison between measurements – one of known magnitude or correctness of one device (standard) and another measurement made in as similar a way as possible with a second device (instrument).
Dew Point	The dew point is the temperature at which a given parcel of humid air must be cooled, at constant barometric pressure, for water vapor to condense into water. The condensed water is called dew. The dew point is a saturation temperature. The dew point is associated with relative humidity. A high relative humidity indicates that the dew point is closer to the current air temperature. Relative humidity of 100% indicates the dew point is equal to the current temperature and the air is maximally saturated with water. When the dew point remains constant and temperature increases, relative humidity will decrease.
HectoPascals (hPa)	Pressure units in SI (international system) units of measurement. Same as millibars (1 hPa = 1 mbar)
Hygrometer	A hygrometer is a device that measures relative humidity. Relative humidity is a term used to describe the amount or percentage of water vapor that exists in air.
Inches of Mercury (inHg)	Pressure in Imperial units of measure. 1 inch of mercury = 33.86 millibars
Rain Gauge	A rain gauge is a device that measures liquid precipitation (rain), as

Term	Definition
	opposed to solid precipitation (snow gauge) over a set period of time. All digital rain gauges are self emptying or self dumping (also referred to as tipping rain gauge). The precision of the rain gauge is based on the volume of rain per emptying cycle.
Range	Range is defined as the amount or extent a value can be measured.
Relative Barometric Pressure	Measured barometric pressure relative to your location or ambient conditions.
Resolution	Resolution is defined as the number of significant digits (decimal places) to which a value is being reliably measured.
Solar Radiation	A solar radiation sensor measures solar energy from the sun. Solar radiation is radiant energy emitted by the sun from a nuclear fusion reaction that creates electromagnetic energy. The spectrum of solar radiation is close to that of a black body with a temperature of about 5800 K. About half of the radiation is in the visible short-wave part of the electromagnetic spectrum. The other half is mostly in the near-infrared part, with some in the ultraviolet part of the spectrum.
Thermometer	A thermometer is a device that measures temperature. Most digital thermometers are resistive thermal devices (RTD). RTDs predict change in temperature as a function of electrical resistance.
Wind Vane	A wind vane is a device that measures the direction of the wind. The wind vane is usually combined with the anemometer. Wind direction is the direction from which the wind is blowing.

6. Specifications

6.1 Wireless Specifications

- Line of sight wireless transmission (in open air): 330 feet, 100 feet under most conditions
- Update Rate: Outdoor Sensor: 16 seconds, Indoor Sensor: 64 seconds
- Frequency: 915 MHz

6.2 Measurement Specifications

The following table provides the specifications for the measured parameters.

Measurement	Range	Accuracy	Resolution
Barometric Pressure	8.85 to 32.50 inHg	± 0.08 inHg (within range of 27.13 to 32.50 inHg)	0.01 inHg

6.3 Power Consumption

- ObserverIp Receiver : 5V DC Adaptor (included)

7. Troubleshooting Guide

If your question is not answered here, you can contact us as follows:

1. Email Support: support@ambientweather.com

2. Help: www.AmbientWeather.net/help
3. Technical Support: 480-346-3380 (M-F 8am to 3pm Arizona Time)

Problem	Solution
<p>Wireless remote (thermo-hygrometer) not reporting in to ObserverIP Receiver.</p>	<p>The maximum line of sight communication range is about 300'. Move the sensor assembly closer to the ObserverIP receiver.</p> <p>Install a fresh set of batteries in the remote sensor(s).</p> <p>Make sure the remote sensors are not transmitting through solid metal (acts as an RF shield), or earth barrier (down a hill). Radio Frequency (RF) Sensors cannot transmit through metal barriers (example, aluminum siding) or multiple, thick walls.</p> <p>Move the ObserverIP receiver around electrical noise generating devices, such as computers, TVs and other wireless transmitters or receivers.</p>
<p>Outdoor sensor array does not communicate to the ObserverIP Receiver.</p>	<p>The sensor array may have initiated properly and the data is registered by the ObserverIP receiver as invalid, and the sensory array must be reset. The reset button is next to the LED, near the mounting point on the sensor array.</p> <p>With an open ended paperclip, press the reset button for 3 seconds to completely discharge the voltage.</p> <p>Take out the batteries and wait one minute, while covering the solar panel to drain the voltage.</p> <p>Put batteries back in and resync with ObserverIP receiver by powering down and up the ObserverIP receiver with the sensor array about 10 feet away.</p> <p>Bring the sensor array inside the house (you can disconnect it from the rest of the sensors). The LED next to the battery compartment will flash every 16 seconds. If the LED is not flashing every 16 seconds...</p> <p>Replace the batteries in the outside sensor array. Non-rechargeable batteries are OK for testing purposes. If the batteries were recently replaced, check the polarity. If the sensor is flashing every 48 seconds, proceed to the next step.</p> <p>There may be a temporary loss of communication due to reception loss related to interference or other location factors,</p> <p>or the batteries may have been changed in the sensor array and the ObserverIP receiver has not been reset. The solution may be as simple as powering down and up the ObserverIP.</p> <p>Replace the batteries in the outside sensor array. Non-rechargeable batteries are OK for testing purposes.</p> <p>With the sensor array and ObserverIP 10 feet away from each other, remove AC power from the ObserverIP receiver and wait 10 seconds. Re-connect power.</p>

Problem	Solution
Absolute pressure does not agree with official reporting station	<p>You may be viewing the relative pressure, not the absolute pressure.</p> <p>Select the absolute pressure. Make sure you properly calibrate the sensor to an official local weather station. Reference Section 3.9 for details.</p>
Data not reporting to Wunderground.com	<ol style="list-style-type: none"> 1. Confirm your password is correct. It is the password you registered on Wunderground.com. Your Wunderground.com password cannot begin with a non-alphanumeric character (a limitation of Wundeground.com, not the station). Example, \$oewkrf is not a valid password, but oewkrf\$ is valid. 2. Confirm your station ID is correct. The station ID is all caps, and the most common issue is substituting an O for a 0 (or visa versa). Example, KAZPHOEN11, not KAZPH0EN11. 3. Make sure your time zone is set properly. If incorrect, you may be reporting old data, not real time data. 4. Check your router firewall settings. The ObserverIP sends data via Port 80.
Only the Power, Link and ACT lights are lit and the ObserverIP module does not communicate to the server.	<p>The firmware will need to be reloaded.</p> <ol style="list-style-type: none"> 1. Download the latest firmware here: ObserverIp Download Center 2. Power down the ObserverIP module but leave connected to your router. 3. Launch the IP Tools application as referenced in Section 3.4.1. Since the module is powered down, you will not be able to locate it on your network, but proceed anyway. 4. Select the Upgrade button. 5. Reference Figure 29. Select the Select File button, and browse to the location of the file you downloaded in Step 1. 6. Select the Upgrade Firmware button. 7. Plug in the ObserverIP module. The software will locate the device on your network and begin the update. <p>Reference Figure 30. The dialog box will display Received a Read Request from the ObserverIP module. A green progress bar will provide you with the upgrade status.</p> <p>DO NOT OPERATE THE MOUSE OR KEYBOARD WHEN UPGRADING to prevent interruption of the upgrade.</p> <ol style="list-style-type: none"> 5. Once the firmware upgrade is complete, the dialog box will display Read session is completed successfully, as shown in Figure 31.

Problem	Solution
	<p data-bbox="570 279 1385 369">6. Wait about one minute for the ObserverIP module to reboot. You can now Exit the upgrade window, and access the module again, as referenced in Section 3.4.</p> <p data-bbox="618 407 1385 464">All of the lights should be on except the Server light (you will need to reprogram the Wunderground.com settings).</p>

8. Liability Disclaimer

Please help in the preservation of the environment and return used batteries to an authorized depot. The electrical and electronic wastes contain hazardous substances. Disposal of electronic waste in wild country and/or in unauthorized grounds strongly damages the environment.

Reading the “User manual” is highly recommended. The manufacturer and supplier cannot accept any responsibility for any incorrect readings and any consequences that occur should an inaccurate reading take place.

This product is designed for use in the home only as indication of weather conditions. This product is not to be used for medical purposes or for public safety information.

The specifications of this product may change without prior notice.

This product is not a toy. Keep out of the reach of children.

No part of this manual may be reproduced without written authorization of the manufacturer.

Ambient, LLC WILL NOT ASSUME LIABILITY FOR INCIDENTAL, CONSEQUENTIAL, PUNITIVE, OR OTHER SIMILAR DAMAGES ASSOCIATED WITH THE OPERATION OR MALFUNCTION OF THIS PRODUCT.

9. FCC Statement

Statement according to FCC part 15.19:

This device complies with part 15 of the FCC rules. Operation is subject to the following two conditions:

1. This device may not cause harmful interference.
2. This device must accept any interference received, including interference that may cause undesired operation.

Statement according to FCC part 15.21:

Modifications not expressly approved by this company could void the user's authority to operate the equipment.

Statement according to FCC part 15.105:

NOTE: This equipment has been tested and found to comply with the limits for a Class B digital device, pursuant to Part 15 of the FCC Rules. These limits are designed to provide reasonable protection against harmful interference in a residential installation. This equipment generates, uses and can radiate radio frequency energy and, if not installed and used in accordance with the instructions, may cause harmful interference to radio communications.

However, there is no guarantee that interference will not occur in a particular installation. If this equipment does cause harmful interference to radio or television reception, which can be determined

by turning the equipment off and on, the user is encouraged to try to correct the interference by one or more of the following measures:

- Reorient or relocate the receiving antenna.
- Increase the separation between the equipment and receiver.
- Connect the equipment into an outlet on a circuit different from that to which the receiver is connected.
- Consult the dealer or an experienced radio/TV technician for help.

10. Warranty Information

Ambient, LLC provides a 1-year limited warranty on this product against manufacturing defects in materials and workmanship.

This limited warranty begins on the original date of purchase, is valid only on products purchased and only to the original purchaser of this product. To receive warranty service, the purchaser must contact Ambient, LLC for problem determination and service procedures.

Warranty service can only be performed by a Ambient, LLC. The original dated bill of sale must be presented upon request as proof of purchase to Ambient, LLC.

Your Ambient, LLC warranty covers all defects in material and workmanship with the following specified exceptions: (1) damage caused by accident, unreasonable use or neglect (lack of reasonable and necessary maintenance); (3) damage resulting from failure to follow instructions contained in your owner's manual; (4) damage resulting from the performance of repairs or alterations by someone other than an authorized Ambient, LLC authorized service center; (5) units used for other than personal use (6) applications and uses that this product was not intended (7) the products inability to receive a signal due to any source of interference or metal obstructions and (8) extreme acts of nature, such as lightning strikes or floods.

This warranty covers only actual defects within the product itself, and does not cover the cost of installation or removal from a fixed installation, normal set-up or adjustments, claims based on misrepresentation by the seller or performance variations resulting from installation-related circumstances.

