Ambient Weather RC-8401 ClearView Projection Radio Controlled Alarm Clock with Barometer, Forecast, Indoor Temperature and Color Changing Outdoor Temperature User Manual



Table of Contents

1.	Introduction	2
2.	Warnings	2
3.	Getting Started	3
3.1	Product Features	3
3.1.1	Display Clock	3
3.1.2	Wireless Transmitter.....	5
3.2	Parts List.....	5
3.3	Powering Up.....	5
3.3.1	Radio Controlled Clock (RCC).....	6
3.4	Siting the Wireless Transmitter Outside	6
4.	Clock Display.....	7
4.1	Normal Time Display Mode.....	7
4.2	Alarm Time Display Mode.....	8
5.	Settings.....	8
5.1	Time, Date, and Language Settings.....	8
5.1.1	Hour Offset.....	9
5.2	Alarm Settings.....	10
5.2.1	Using the Alarm and Snooze Functions	10
5.3	Projector and Backlight.....	11
5.3.1	Using the Projector and Backlight	11
5.3.2	Projector Rotation	11
5.3.3	Adjusting Projector Focus.....	11
5.4	Barometric Pressure Display and Settings	12
5.4.1	Barometric Pressure Units of Measure.....	12
5.4.2	Absolute Pressure vs. Relative Pressure.....	12
5.4.3	Relative Pressure Calibration	12
5.5	The Forecast Icon	13
5.5.1	Principle of Forecasting based on Barometric Pressure	13
5.5.2	Weather Forecast Initialization.....	13
5.6	Viewing Minimum and Maximum Records (Memory Mode)	13
5.7	Viewing Historical Data (History Mode)	13
5.8	Color Changing Feature	14
5.8.1	Manual Color Preference	14
5.8.2	Outdoor Temperature Color	14
5.9	Low Temperature Notification	14
5.10	Back Light On/Off.....	15
5.11	Back Light Brightness	15
5.12	Wireless Sensor Display.....	15
5.13	Wireless Sensor Low Battery Indicator.....	15

5.14	Viewing the Wireless Sensor Channels	16
5.15	Syncing and Resyncing the Wireless Sensor.....	16
5.16	Adding Multiple Wireless Sensors	16
6.	Specifications.....	16
6.1	Wireless Specifications	16
6.2	Measurement Specifications.....	16
6.2	Power Consumption.....	17
7.	Troubleshooting Guide.....	17
8.	Accessories	18
9.	Liability Disclaimer	18
10.	FCC Statement.....	19
11.	Warranty Information	19

1. Introduction

Thank you for your purchase of the Ambient Weather RC-8401 ClearView Projection Radio Controlled Alarm Clock with Barometer, Forecast, Indoor Temperature and Color Changing Outdoor Temperature. The following user guide provides step by step instructions for installation, operation and troubleshooting. To download the latest full sized manual and additional troubleshooting tips, please visit:

<http://ambientweather.wikispaces.com/rc8401>

2. Warnings

- ⚠ **Warning.** Never look directly into the time and temperature projector. This can cause temporary blindness.
- ⚠ **Warning.** Only use approved AC adapter.

3. Getting Started

3.1 Product Features

3.1.1 Display Clock

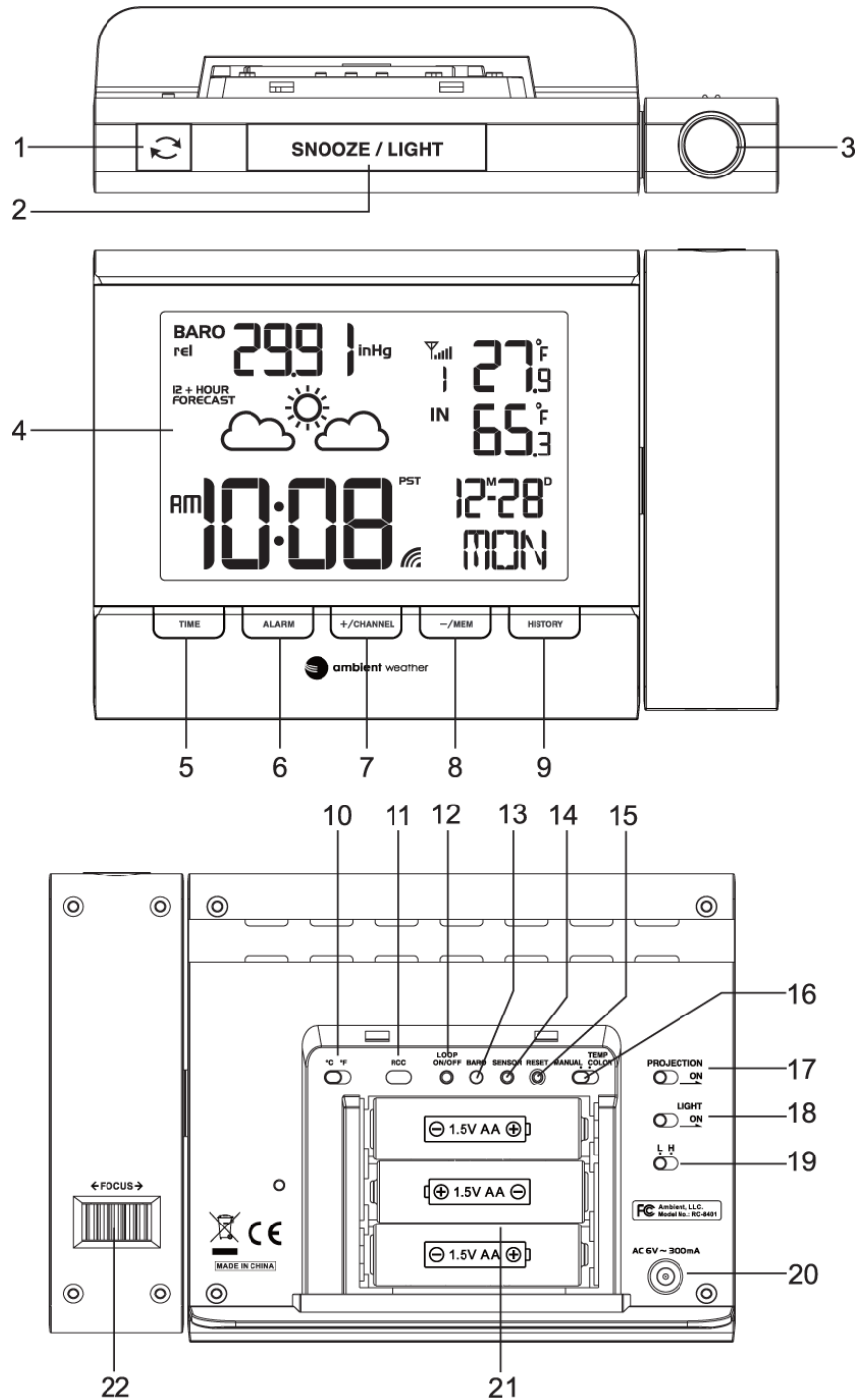

Figure 1

No	Description	No	Description
1	REVERSE Button - Press to reverse the projected time and temperature.	12	Loop ON / OFF
2	SNOOZE/LIGHT Button - Turn on the projector and backlight for 5 seconds. - Stop the current alarm when sounding and enter into snooze mode.	13	BARO button - Press to change barometric pressure units of measure.
3	PROJECTOR - Projects the time and indoor/outdoor temperature (automatically scrolls between indoor and outdoor temperature every 5 seconds).	14	SENSOR Button
4	LCD Display	15	RESET Button - Press to reset all values to default values. - In case of malfunction, the unit can be reset.
5	TIME Button - Press to switch between Month/Date and alarm time mode (Alarm 1 and 2). - Press and hold for 2 seconds to enter time set mode. - In time set mode, press to step through the different time and date settings.	16	PROJECTION On/Off Switch - Turns the time and temperature projection on or off.
6	ALARM Button - In normal time display mode, Press TIME button to display ALM1 & ALM2. Press ALARM to turn on/off ALM1 & ALM2. - Press to stop the current alarm when the alarm is ringing and turn off the alarm and snooze function. - In alarm time mode, press and hold for 2 seconds to enter alarm time setting mode. - In alarm time setting mode, press to step through the different time and date settings.	17	LIGHT On/Off Switch - Turns the back light on and off.
7	+/CHANNEL Button - In set mode, press to increase the values. - In normal time display mode, press to switch between Channels 1, 2 and 3. - In normal time display mode, press and hold for 2 seconds to automatically scroll between sensor channels 1, 2 and 3.	18	L/H Dim Switch - Sets the back light to high or low.
8	-/MEM Button - In set mode, press to decrease the values. In normal mode, press to display minimum and maximum numbers stored in memory.	19	DC POWER JACK

No	Description	No	Description
9	HISTORY Button - In normal mode, press to view hourly historical data stored in memory.	20	BATTERY COMPARTMENT - Accommodates 3 x AA batteries (alkaline recommended).
10	°F/°C Button - Select switch between °F and °C units of measure.	21	FOCUS Knob - Adjust the focus of the projected time and temperature.

3.1.2 Wireless Transmitter

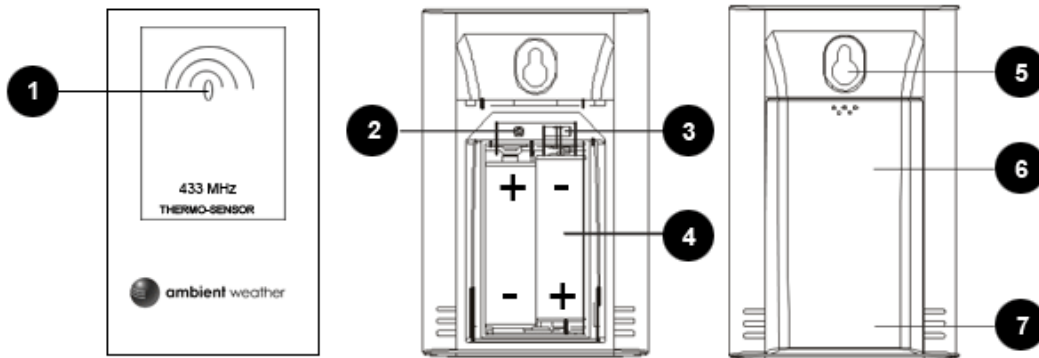

Figure 2

No	Description	No	Description
1	Transmitter LED (flashes when the remote is transmitting)	5	Wall hanger
2	Reset button (press reset to restart the transmitter)	6	Battery cover
3	Transmitter channel (assign the transmitter to 1,2 or 3, default = 1)	7	Table stand
4	2 x AA batteries		

Note: The WS-8400 supports three wireless channels. If you have one sensor, leave the transmitter channel at Channel 1. If you have more than one sensor, refer to Section 5.16.

3.2 Parts List

QTY	Item
1	Clock Frame Dimensions (LxWxH): 5.25" L x 1.5"D x 3.5"H
1	Wireless Transmitter (LxWxH): 4.0" L x 2.5" W x 1.5" D
1	UL Rated AC Adapter
1	User Manual

3.3 Powering Up

 **Note:** The power up sequence must be performed in the order shown in this section (remote transmitter **FIRST**, Display Clock **SECOND**) to avoid the Clock synchronization time out.

The Transmitter:

1. Remove the battery door on the back of the transmitter and insert 2 new AA batteries, according to the polarity information marked on the battery compartment, and replace the battery door, as shown in Figure 2. Place the transmitter about 5 feet from the clock.

The Clock:

1. Plug the AC adaptor into the DC jack of the clock.
2. Remove the battery door on the bottom of the clock and insert 3 new AA batteries, according to the polarity information marked on the battery compartment, and replace the battery door.
3. Once the batteries are inserted, all of the LCD segments will light up briefly before entering the sensor search mode.
4. Once the wireless transmitter has synced up to the clock (can take up to 5 minutes), you can place the sensor outside.
5. The clock will display 12:00am and will attempt to synchronize with the RCC at 12:05am.

The clock will automatically search for the time signal at 2:00, 8:00, 14:00 (2pm) and 20:00 (8pm).

 **Note: The clock will always display the color green when the clock is searching for the radio controlled signal. The mono color green is best for avoiding wireless interference from the display.**

 **Note:** If no display is present after powering up the clock, press the reset button on the back of the clock with an open ended paper clip or sharp tool.

3.3.1 Radio Controlled Clock (RCC)

Five minutes after power up, the clock begin radio controlled clock (RCC) reception and the RCC

search icon  will turn on. The RCC will continue to search for six minutes. It will try again every two hours.





RCC Icon	Description	RCC Icon	Description
	No signal		Acceptable signal
	Weak signal		Excellent signal

Figure 3

If the time is incorrect by increments of an hour, or does not change on your radio controlled clock (RCC), please reference Section 7, Troubleshooting Guide.

3.4 Siting the Wireless Transmitter Outside

It is recommended you place the remote sensor in a shaded area.

Direct sunlight and radiant heat sources will result in inaccurate temperature readings. Although the sensor is weatherproof, it is best to mount in a well-protected area, such as an eave. Do not place in standing water or snow.

Wireless signals are impacted by distance, interference (other wireless devices, wireless phones, wireless routers, TVs and computer monitors), and transmission barriers, such as walls. In general,

wireless signals will not penetrate solid metal and earth (down a hill, for example).

The following is a table of reception loss vs. the transmission medium. Each “wall” or obstruction decreases the transmission range by the factor shown below.

Medium	RF Signal Strength Reduction
Glass (untreated)	5-15%
Plastics	10-15%
Wood	10-40%
Brick	10-40%
Concrete	40-80%
Metal	90-100%

4. Clock Display

4.1 Normal Time Display Mode

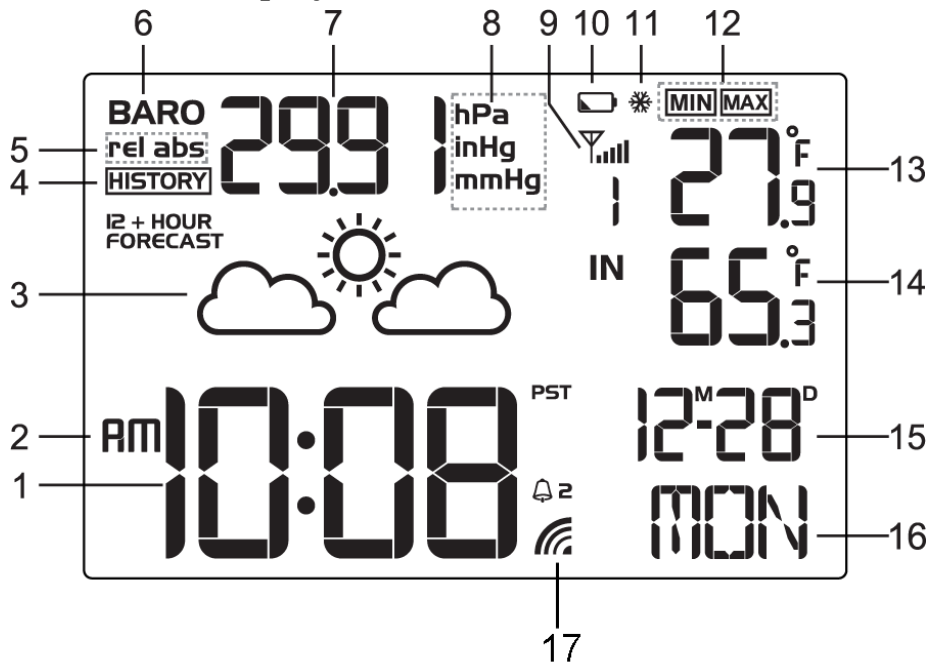

No	Description	No	Description
1	Time	10	Low battery indicator
2	AM / PM	11	Low Temperature Alert
3	Weather Forecast	12	Min/Max indicator
4	History Mode indicator	13	Wireless temperature (channels 1, 2 or 3)
5	Rel / Abs Pressure	14	Indoor temperature
6	Barometer indicator	15	Month and Day
7	Barometer reading	16	Day of Week
8	Barometer units of measure (inHg, hPa, mmHg)	17	Radio Controlled Time Reception Icon
9	Wireless signal strength indicator		

Figure 4

4.2 Alarm Time Display Mode

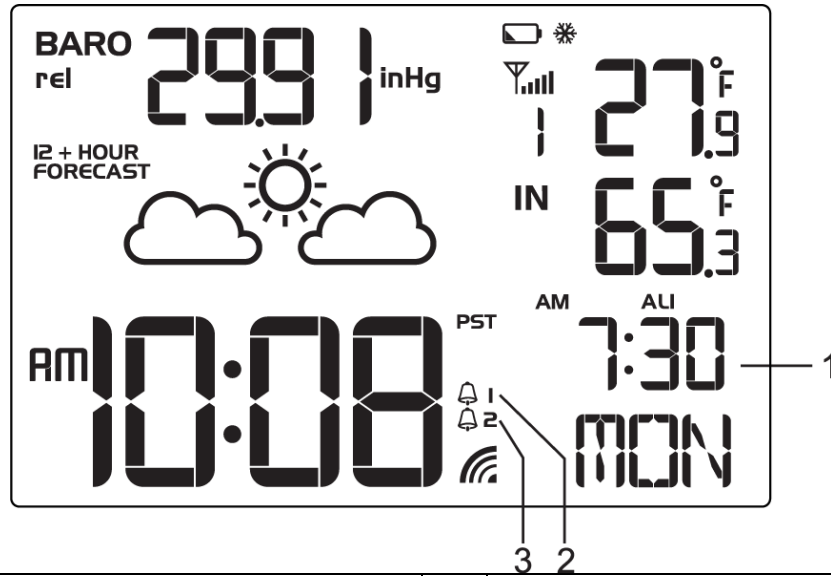

No	Description	No	Description
1	Alarm Time	3	Alarm 2 On
2	Alarm 1 On		

Figure 5

5. Settings

5.1 Time, Date, and Language Settings

While in normal time mode, perform the following operations to set date, time and language:

Command	Mode	Settings
[TIME] + 2 seconds	Enter Time and Date Settings 12 hour / 24 hour format	Press [+/ CHANNEL] to change between 12H and 24H format.
[TIME]	Time Zone	Press [+/ CHANNEL] to change between Pacific (PST), Mountain (MST), Central (CST) and Eastern (EST) Standard Time
[TIME]	Hour	Press [+/ CHANNEL] to increase, [-/ MEM] to decrease.
[TIME]	Minute	Press [+/ CHANNEL] to increase, [-/ MEM] to decrease.
[TIME]	Year	Press [+/ CHANNEL] to increase, [-/ MEM] to decrease.
[TIME]	Month / Day Format	Press [+/ CHANNEL] to change between Month/Day (M-D) and Day/Month (D-M).
[TIME]	Month	Press [+/ CHANNEL] to increase, [-/ MEM] to decrease.
[TIME]	Day	Press [+/ CHANNEL] to increase, [-/ MEM] to decrease.
[TIME]	Hour Offset (see Section 5.1.1)	Press [+/ CHANNEL] to increase, [-/ MEM] to decrease.
[TIME]	Language	Press [+/ CHANNEL] to change between EN (English), FR (French), DE (German), ES (Spanish) and IT (Italian).
[TIME]	Daylight Savings Time	Press [+/ CHANNEL] to change between auto (most of USA and Canada) and OFF (Arizona and Hawaii)
[TIME]	Exit Time and Date Settings	

[TIME] + 2 seconds means press and hold the TIME button for two seconds.

[TIME] means press but do not hold the TIME button.

Figure 6

5.1.1 Hour Offset

The clock allows you to set four time zones: Pacific (PST), Mountain (MST), Central (MST) and Eastern (EST) Standard Time. If you live outside of these time zones, you will need to set an hour adjustment, as defined in Section 5.1.

Note that you must make sure the time zone is set to PST before you enter the hour offset.

Hours from PST	Time Zone	Cities
-4	IDLW: International Date Line West	---
-3	NT: Nome	Nome, AK
-2	AHST: Alaska-Hawaii Standard CAT: Central Alaska HST: Hawaii Standard	Honolulu, HI
-1	YST: Yukon Standard	Yukon Territory
0	PST: Pacific Standard	Los Angeles, CA, USA
1	MST: Mountain Standard	Denver, CO, USA
2	CST: Central Standard	Chicago, IL, USA
3	EST: Eastern Standard	New York, NY, USA
4	AST: Atlantic Standard	Caracas

Hours from PST	Time Zone	Cities
5	---	São Paulo, Brazil
6	AT: Azores	Azores, Cape Verde Islands
7	WAT: West Africa	---
8	GMT: Greenwich Mean WET: Western European	London, England
9	CET: Central European	Paris, France
10	EET: Eastern European	Athens, Greece
11	BT: Baghdad	Moscow, Russia
12	---	Abu Dhabi, UAE
13	---	Tashkent
14	---	Astana
15	---	Bangkok
16	CCT: China Coast	Beijing
17	JST: Japan Standard	Tokyo
18	GST: Guam Standard	Sydney
19	---	Magadan
20	IDLE: International Date Line East NZST: New Zealand Standard	Wellington, New Zealand

5.2 Alarm Settings

While in normal time mode, press the **TIME** button once to set **ALARM1**. Press the **TIME** button again to set **ALARM2**. Once **ALARM1** or **ALARM2** are displayed in the date field (see Figure 4, No. 10), perform the following:







Command	Mode	Settings
[ALARM] + 2 seconds	Enter Alarm Settings Alarm Hour	Press [+ / CHANNEL] to increase, [- / MEM] to decrease.
[ALARM]	Alarm Minute	Press [+ / CHANNEL] to increase, [- / MEM] to decrease.
[ALARM]	Exit Alarm Settings	

[ALARM] + 2 seconds means press and hold the ALARM button for two seconds.

[ALARM] means press but do not hold the ALARM button.

Figure 7

5.2.1 Using the Alarm and Snooze Functions

1. Set the alarm time as described in Section 5.2. While in normal time mode:
2. Press the **ALARM** button once to turn on **ALARM1**  1.
3. Press the **ALARM** button again to turn on **ALARM2**  2.
4. Press the **ALARM** button again to turn on  1 and  2.
5. Press the **ALARM** button again to turn off  1 and  2.

 **Note:** Press the **ALARM** button to turn off the alarm sound. If no button is pressed during the alarm period, the alarm will turn off automatically in two minutes. To temporarily silence the alarm, press the **SNOOZE/LIGHT** button on the top of the clock. The alarm bell icon will keep flashing.

If the snooze function is turned on, the 4-step crescendo alarm will sound every five minutes. Press the

ALARM button to silence the alarm.

5.3 Projector and Backlight

5.3.1 Using the Projector and Backlight

 **Note:** The projector and backlight are temporary when operating on batteries only, to save battery life.

1. **When the clock is powered by the battery:**

Press the **SNOOZE/LIGHT** button to turn on the projector and backlight for 5 seconds

or press and hold the **SNOOZE/LIGHT** button for 4 seconds to turn on the projection for 30 minutes. Press the **SNOOZE/LIGHT** button again to turn off the projection.

2. **When the clock is powered by the AC adapter:**

Slide the **PROJECTION ON/OFF** switch to **ON** position, and the projection will be on all of the time.

Slide the **PROJECTION ON/OFF** switch to **OFF** position, and the projection will be off all of the time, unless you press the **SNOOZE/LIGHT** button as described in the previous section.

Slide the **LIGHT ON/OFF** switch to **ON** position, and the backlight will be on all the time.

Slide the **LIGHT ON/OFF** switch to **OFF** position, and the backlight will be off all of the time, unless you press the **SNOOZE/LIGHT** button as described in the previous section.

5.3.2 Projector Rotation

Press the **REVERSE** button  to reverse the projected data 180 degrees.



Figure 8

5.3.3 Adjusting Projector Focus

Adjust the focus of the projected data by rotating the focus knob on the projector.

5.3.4 Projector Temperature Display

The projector will scroll between the indoor and outdoor temperature. Each time you add an additional channel sensor, the projector will add this sensor to the scroll feature. The scroll feature cannot be disabled.

5.4 Barometric Pressure Display and Settings

5.4.1 Barometric Pressure Units of Measure

In normal time mode, press the **BARO** button to change barometric units of measure (hPa / inHg / mmHg).

5.4.2 Absolute Pressure vs. Relative Pressure

Press and hold the **BARO** button for 2 seconds to enter barometric mode, and press the **+/CHANNEL** button to switch between the relative and absolute pressure reading.

5.4.3 Relative Pressure Calibration

Please Reference Section 5.4.3.1 for details on the purpose of calibrating relative pressure, and how to calibrate relative pressure in your area.

1. Press and hold the **BARO** button for 2 seconds to enter barometric mode. The icon **BARO** will flash.

Make sure the REL Pressure is showing on the display. If ABS Pressure is showing, switch to REL pressure per Section 5.4.2.

2. Press (do not hold) the **BARO** button again. The relative pressure will flash.
3. Press the **+/CHANNEL** to increase the relative pressure and **-/MEM** to decrease the relative pressure.
4. Press (do not hold) the **BARO** button again to exit the relative pressure calibration mode, or wait 60 seconds to time out.

Note: After calibration, the barograph will reset to 0 change (flat line across the graph).

5.4.3.1 Relative vs. Absolute Pressure and Calibration

The clock displays two different pressures: absolute (measured) and relative (corrected to sea-level).

To compare pressure conditions from one location to another, meteorologists correct pressure to sea-level conditions. Because the air pressure decreases as you rise in altitude, the sea-level corrected relative pressure (the pressure your location would be at if located at sea-level) is generally higher than your measured absolute pressure.

Thus, your absolute pressure may read 28.62 inHg (969 mb) at an altitude of 1000 feet (305 m), but the relative pressure is 30.00 inHg (1016 mb).

The standard sea-level pressure is 29.92 in Hg (1013 mb). This is the average sea-level pressure around the world. Relative pressure measurements greater than 29.92 inHg (1013 mb) are considered high pressure and relative pressure measurements less than 29.92 inHg are considered low pressure.

To determine the relative pressure for your location, locate an official reporting station near you (the internet is the best source for real time barometer conditions, such as Weather.com or Wunderground.com), and set your weather station to match the official reporting station.

5.5 The Forecast Icon

5.5.1 Principle of Forecasting based on Barometric Pressure

The weather forecast or pressure tendency is based on the rate of change of barometric pressure. In general, when the pressure increases, the weather improves (sunny to partly cloudy) and when the pressure decreases, the weather degrades (cloudy to rain).

The weather forecast is an estimation or generalization of weather changes in the next 12 to 36 hours, and varies from location to location. The tendency is simply a tool for projecting weather conditions and is never to be relied upon as an accurate method to predict the weather.

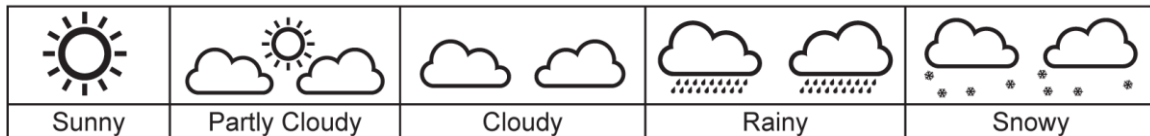

Figure 9

5.5.2 Weather Forecast Initialization

When the console is powered up, the forecast prediction is in the “learning mode” and may take several days to begin forecasting the weather. In the meantime, the forecast icon will show partly cloudy.

5.6 Viewing Minimum and Maximum Records (Memory Mode)

While in normal time mode, perform the following operations to view the minimum and maximum values since the last time they were reset.

Command	Mode	Settings
[-/MEM]	Displays Outdoor Maximum Temperature and the associated date and time.	Press and hold [-/MEM] for two seconds to reset the maximum outdoor temperature to the current value.
[-/MEM]	Displays Outdoor Minimum Temperature and the associated date and time.	Press and hold [-/MEM] for two seconds to reset the minimum outdoor temperature to the current value.
[-/MEM]	Displays Indoor Maximum Temperature and the associated date and time.	Press and hold [-/MEM] for two seconds to reset the maximum indoor temperature to the current value.
[-/MEM]	Displays Indoor Minimum Temperature and the associated date and time.	Press and hold [-/MEM] for two seconds to reset the minimum indoor temperature to the current value.
[-/MEM]	Displays Maximum Barometer and the associated date and time.	Press and hold [-/MEM] for two seconds to reset the maximum barometer to the current value.
[-/MEM]	Displays Minimum Barometer and the associated date and time.	Press and hold [-/MEM] for two seconds to reset the minimum barometer to the current value.
[-/MEM]	Exit memory mode.	

Figure 10

5.7 Viewing Historical Data (History Mode)

In the normal time mode, press the **HISTORY** button to display one hour increments of the last 72 hours of historical data, including indoor temperature, outdoor temperature, and barometric pressure.

If no button is pressed for 5 seconds, the display will return to the normal time mode.

5.8 Color Changing Feature

This display has two color models for the LCD backlight based on the **MANUAL/TEMP COLOR** slide switch in the battery compartment:

- **Manual** based on your personal preference
- **Temp Color**, based on outdoor temperature.

5.8.1 Manual Color Preference

1. Place the **MANUAL/TEMP COLOR** slide switch in the manual position.
2. Press the **LOOP ON / OFF** button, and the display will cycle through all of the possible colors. Once the preferred color is displayed, press the **LOOP ON / OFF** button again to stop the color cycling.

5.8.2 Outdoor Temperature Color

Place the **MANUAL/TEMP COLOR** slide switch in the temp position. The display color will automatically change based on the color chart below:

#	Temperature Range (°F)	Color
1	< 0	White
2	0 - 10	Violet
3	10-20	Dark Blue
4	20-30	Light Blue
5	30-40	Dark Aqua
6	40-50	Light Aqua
7	50-60	Green
8	60-70	Light Green
9	70-80	Yellow
10	80-90	Orange
11	90-100	Red
12	100-110	Light Red
13	> 110	Gray

Figure 11

5.9 Low Temperature Notification

When the outdoor temperature is between 28°F to 37°F (-2°C to 3°C), the low temperature alert icon will be displayed and flash continuously, and disappear once the temperature is out of this range.

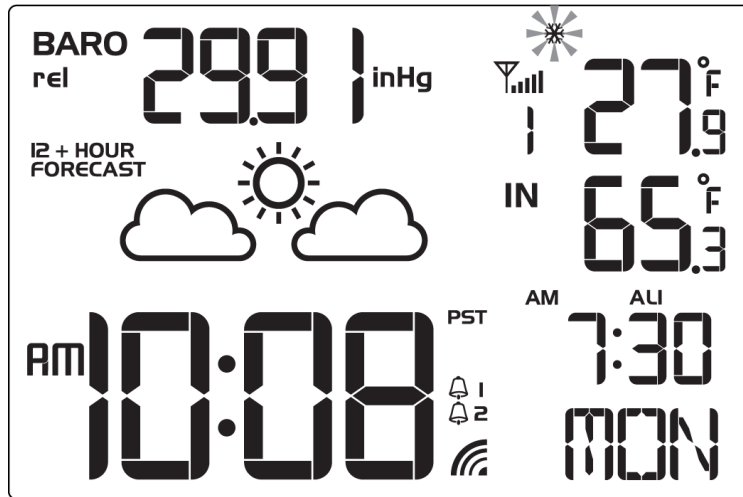

Figure 12

5.10 Back Light On/Off

To turn the back light on or off, slide the **LIGHT On/Off Switch**.

If the back light is off, press the **SNOOZE/LIGHT** button to temporarily turn it on.

5.11 Back Light Brightness

To select the back light brightness, slide the L/H switch (low/high).

5.12 Wireless Sensor Display

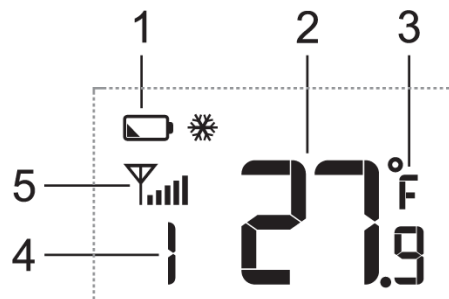

No	Description	No	Description
1	Low Battery Indicator	4	Temperature Channel Number
2	Temperature	5	Channel Number (default = 1) and Reception Icon (on when searching, flashes when updates)
3	Temperature Units of Measure (°F or °C)		

Figure 13

5.13 Wireless Sensor Low Battery Indicator

When the battery is full, no battery icon will be displayed. When the battery is low, the low battery indicator  will be displayed. Replace with 2 new AA size batteries. Pay attention to the

polarity.

5.14 Viewing the Wireless Sensor Channels

In normal time mode, press the **UP** button to view wireless channels 1, 2 and 3.

To automatically scroll through channels 1, 2 and 3, press and hold the **UP** button for 2 seconds (the beep will sound). The wireless channels will scroll on the screen every 5 seconds.

5.15 Syncing and Resyncing the Wireless Sensor

If the sensor is synced to the console, the console will display the reception icon with the signal strength . If the sensor signal is lost, dashes --.- will be displayed in place of temperature.

If you lose synchronization from the remote wireless sensor for an extended period of time or you replace the batteries in the wireless sensor, you may need to resync or reset the sensor to the console.

To resync the sensor(s), press the **SENSOR** button in the battery compartment and the sensor display will show dashes (--.-). Wait several minutes for resynchronization.

To reset the console, disconnect from AC power and remove the batteries for 10 seconds, then reinsert the batteries and reconnect AC power. Alternately, you can press the **RESET** button on the back of the console. The sensor display will show dashes (--.-). Wait several minutes for resynchronization.

5.16 Adding Multiple Wireless Sensors

If you introduce additional sensors into the system, you will need to reset the console.

1. Set the Channel number on the wireless sensor per Figure 2. Power down and up the sensor after you have changed the channel number for the change to take effect.
2. Resync the console. Reference Section 5.15.

6. Specifications

6.1 Wireless Specifications

- Line of sight wireless transmission (in open air): 150 feet
- Frequency: 433 MHz
- Update Rate: 60 seconds

6.2 Measurement Specifications

The following table provides specifications for the measured parameters.

Measurement	Range	Accuracy	Resolution
Indoor Temperature	32 to 113 °F	± 2 °F	0.1
Outdoor Temperature	-4 to 140 °F alkaline batteries -22 to 140 °F Lithium e2 Energizer batteries	± 2 °F	0.1

Barometer	540 to 1100mb (15.95 inHg to 32.48 inHg) Altitude Range: -2,300 to 16,400' (-700 to 5000 meters)	± 8mb (540 to 969mb) @ 25 °C ± 5mb (970 to 1030mb) @ 25 °C ± 8mb (1031 to 1100mb) @ 25 °C	1hPa / 0.01inHg / 0.1mmHg
-----------	--	---	---------------------------

6.2 Power Consumption

- Display: 3 x AA Alkaline batteries recommended.
- Display: DC 4.5V, 300mA adaptor
- Wireless Transmitter: 2 x AA Alkaline batteries recommended, Lithium e2 Energizer for cold weather.

7. Troubleshooting Guide

If your question is not answered here, you can contact us as follows:

1. Email Support: support@ambientweather.com
2. Technical Support: 480-346-3380 (M-F 8am to 4pm Arizona Time)

Problem	Solution
The wireless sensor communication has been lost or is intermittent or will not sync up.	<ul style="list-style-type: none"> • Make sure the transmitter is powered up and the LED is flashing about once per minute. For cold weather environments, install lithium batteries. If the transmitter is not flashing, replace the batteries. • Resync the console. Reference Section 5.15. • The maximum line of sight communication range is 150'. Move the sensor closer to the clock. • If the sensor assembly is too close (less than 5-10'), move the sensor away from the clock. • Make sure the remote sensors are not transmitting through solid metal (acts as an RF shield), or earth barrier (down a hill). • Move the clock away from electrical noise generating devices, such as computers, TVs and other wireless transmitters or receivers. • Move the remote sensor to a higher location. Move the remote sensor to a closer location. • Radio Frequency (RF) Sensors cannot transmit through metal barriers (example, aluminum siding) or multiple, thick walls.
The clock does not respond to commands.	<ul style="list-style-type: none"> • Press the reset button on the back of the clock with an open ended paper clip or sharp tool.
The projection is fuzzy	<ul style="list-style-type: none"> • Adjust the focus setting.
The clock is dim when running on batteries only.	<ul style="list-style-type: none"> • Press the snooze/light button or connect to AC Power.
The display is green when it should be a different color	<ul style="list-style-type: none"> • The clock display color will always display green while the clock is searching for the radio controlled signal. The mono color green is best for avoiding interference from the display.

8. Accessories

Accessory	Description
TX-8300	Additional wireless sensor.

9. Liability Disclaimer

Please help in the preservation of the environment and return used batteries to an authorized depot. The electrical and electronic wastes contain hazardous substances. Disposal of electronic waste in wild country and/or in unauthorized grounds strongly damages the environment.

Reading the "User manual" is highly recommended. The manufacturer and supplier cannot accept any

responsibility for any incorrect readings and any consequences that occur should an inaccurate reading take place.

This product is designed for use in the home only as indication of weather conditions. This product is not to be used for medical purposes or for public information.

The specifications of this product may change without prior notice.

This product is not a toy. Keep out of the reach of children.

No part of this manual may be reproduced without written authorization of the manufacturer.

Ambient, LLC WILL NOT ASSUME LIABILITY FOR INCIDENTAL, CONSEQUENTIAL, PUNITIVE, OR OTHER SIMILAR DAMAGES ASSOCIATED WITH THE OPERATION OR MALFUNCTION OF THIS PRODUCT.

10. FCC Statement

Statement according to FCC part 15.19:

This device complies with part 15 of the FCC rules. Operation is subject to the following two conditions:

1. This device may not cause harmful interference.
2. This device must accept any interference received, including interference that may cause undesired operation.

Statement according to FCC part 15.21:

Modifications not expressly approved by this company could void the user's authority to operate the equipment.

Statement according to FCC part 15.105:

NOTE: This equipment has been tested and found to comply with the limits for a Class B digital device, pursuant to Part 15 of the FCC Rules. These limits are designed to provide reasonable protection against harmful interference in a residential installation. This equipment generates, uses and can radiate radio frequency energy and, if not installed and used in accordance with the instructions, may cause harmful interference to radio communications.

However, there is no guarantee that interference will not occur in a particular installation. If this equipment does cause harmful interference to radio or television reception, which can be determined by turning the equipment off and on, the user is encouraged to try to correct the interference by one or more of the following measures:

- Reorient or relocate the receiving antenna.
- Increase the separation between the equipment and receiver.
- Connect the equipment into an outlet on a circuit different from that to which the receiver is connected.
- Consult the dealer or an experienced radio/TV technician for help.

11. Warranty Information

Ambient, LLC provides a 1-year limited warranty on this product against manufacturing defects in materials and workmanship.

This limited warranty begins on the original date of purchase, is valid only on products purchased and only to the original purchaser of this product. To receive warranty service, the purchaser must contact Ambient, LLC for problem determination and service procedures.

Warranty service can only be performed by a Ambient, LLC. The original dated bill of sale must be presented upon request as proof of purchase to Ambient, LLC.

Your Ambient, LLC warranty covers all defects in material and workmanship with the following specified exceptions: (1) damage caused by accident, unreasonable use or neglect (lack of reasonable and necessary maintenance); (2) damage resulting from failure to follow instructions contained in your owner's manual; (3) damage resulting from the performance of repairs or alterations by someone other than an authorized Ambient, LLC authorized service center; (4) units used for other than home use (5) applications and uses that this product was not intended (6) the products inability to receive a signal due to any source of interference or metal obstructions and (7) extreme acts of nature, such as lightning strikes or floods.

This warranty covers only actual defects within the product itself, and does not cover the cost of installation or removal from a fixed installation, normal set-up or adjustments, claims based on misrepresentation by the seller or performance variations resulting from installation-related circumstances.

