Ambient Weather WeatherBridge Universal Weather Station Server Quick Start Guide



Table of Contents

1	Introduction.....	2
2	Packing List	2
3	Connections.....	2
3.1	USB Connection.....	2
3.2	IP Connection	4
3.2.1	Davis Vantage Pro and VantageVue IP Data Logger.....	4
3.2.2	Acurite Internet-Bridge	5
4	3BIP Addressing (finding the WeatherBridge).....	5
4.1	Magic IP Finder.....	5
4.2	Software Scan Tool (alternate IP finder)	5
4.3	Reading the Blinks from the Status/Reset Light (alternate IP finder)	6
4.4	Using USB Stick (alternate IP finder)	7
5	4BBrowser Access	7
6	5BLicense	7
7	System.....	8
7.1	Network.....	8
7.2	Security (password).....	9
7.3	Localization.....	9
8	6BSSetup Network.....	11
8.1	Type of Connection and Configuring WiFi	11
8.2	IP Address.....	11
8.3	Restoring the default IP Address	11
8.4	Restoring to Factory Default	11
8.5	Advanced Network Settings	11
9	Select Station	12
9.1	Weather Station Type.....	12
9.2	WeatherLinkIP (WLIP)	13
9.3	Altitude.....	13
10	8Live Data	14
11	Weather Network.....	15
11.1	Wunderground.com (Weather Underground)	15
11.2	Other Web Hosting Services.....	16
12	Push Services: Twitter, Email and MySQL	18
13	AirCam Weather Camera (optional).....	19
13.1	Registering your AirCam on Wunderground.com.....	20
14	More Information	20
15	12BLiability Disclaimer	20
16	13BWarranty Information.....	21

1 Introduction



Note: For technical issues, please email info@meteohub.de.

Please include your license key (Figure 7) in the email. With this information, the developer can login to your device. If this acceptable, grant the developer authority in your email.

The following quick start programming guide provides basic instructions for connecting your WeatherBridge to your weather station and router and the Internet. This is a supplement to the detailed information provided at www.MeteoBridge.com.

Note: Ambient Weather uses the terms WeatherBridge and MeteoBridge interchangeably. WeatherBridge is the complete product, including the Linux computer (TP-LINK), and operating system. The operating system is referred to as MeteoBridge, developed by smartbedded UG, on the web at www.MeteoBridge.com.

Note: The WeatherBridge has been programmed and licensed by Ambient Weather before you receive it. For warranty replacement, please contact Ambient Weather directly. Ambient Weather warranties this product for 1 year.

The unit has been tested thoroughly before shipping.

2 Packing List

The packing list is as follows:

1. WeatherBridge Linux Computer (TP-LINK)
2. WeatherBridge AC adaptor
3. Ethernet Cable
4. Quick Start Guide

3 Connections

There are two weather station connections supported by the WeatherBridge:

1. USB
2. TCPIP

3.1 USB Connection

Connect the WeatherBridge Computer as follows (reference Figure 1):

1. Connect the weather station USB connection into the USB port on the WeatherBridge.

Note: If you have a weather station with a serial port, you will need a USB converter and serial cable available here:

<http://www.ambientweather.com/cousbto9sead.html> and
<http://www.ambientweather.com/secoca6.html>

Note: If you have a WeatherLinkIP 6555 data logger, connect this logger into your router directly. WeatherBridge will communicate to this device over your local area network.

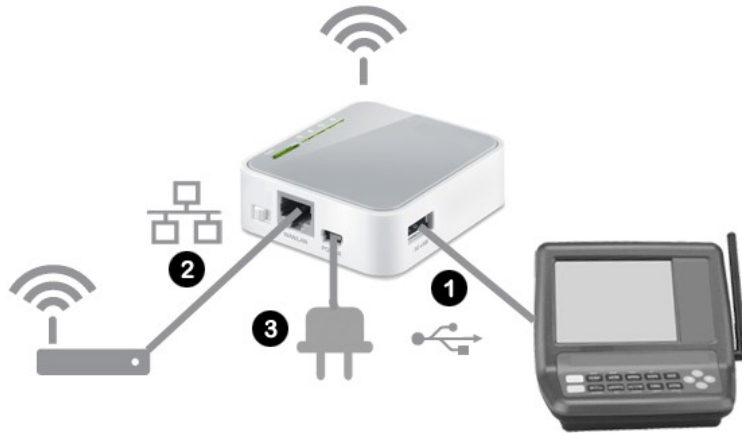

Figure 1
USB Connection

If your weather station does not support USB 2.0, you will need to connect the USB hub (optional) between the weather station console and the WeatherBridge, as shown in Figure 2.

The following table summarizes the USB version for most weather stations:

Weather Station	USB
Ambient Weather (WS-1080, WS-1090, WS-2080)	1.X
Davis Instruments VantagePro, VantagePro2 and VantageVue 6510USB and 6520 WeatherLink Data Logger	1.X
Fine Offset WH-1080, WH-2080, WH-3080	1.X
Honeywell / Meade TE923, TE827, TE821, DV928, Hideki, Mebus, IROX	1.X
La Crosse/ELV: WS-2300 Series, WS-300-PC, WS-300-PC-2, WS-300-PC-US, WS-444, WS-500, WS-550-Technoline, WS-550-US, WS-550-2-US, WS-777, WS-888, WDE1	1.X
Oregon Scientific WMR-88, WMR-100, WMR-200, WMRS-200	1.X
Peet Bros: Ultimeter 100/800/2000/2100/II (requires USB to Serial Converter)	Check your device
Rainwise MKIII Series, serial data logger (requires USB to Serial Converter)	Check your device
USB to Serial converters	Check your device

Use USB Hub for 1.X. No USB hub required for 2.0.

2. Connect the WeatherBridge to your router or switch.
Note: a cabled connection is required to configure the device. It can later be disconnected after the optional WiFi LAN is configured.
3. Connect the AC power adaptor to the WeatherBridge. The power light will turn ON (reference **Figure 2**).
4. The Status/Reset light will flash slowly, then rapidly, then solid green. This process can take several minutes.

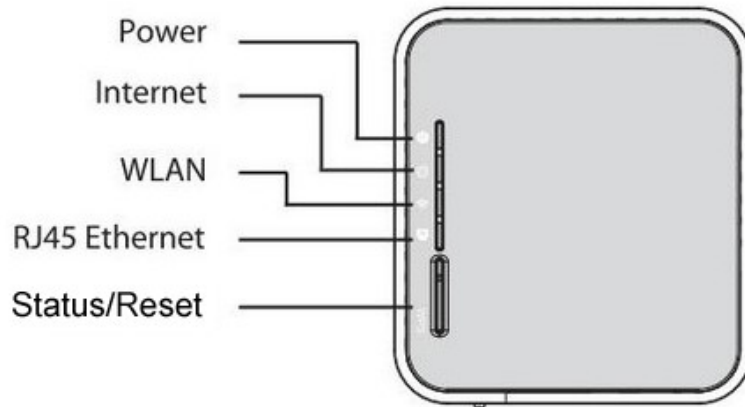

Figure 2
Status Lights

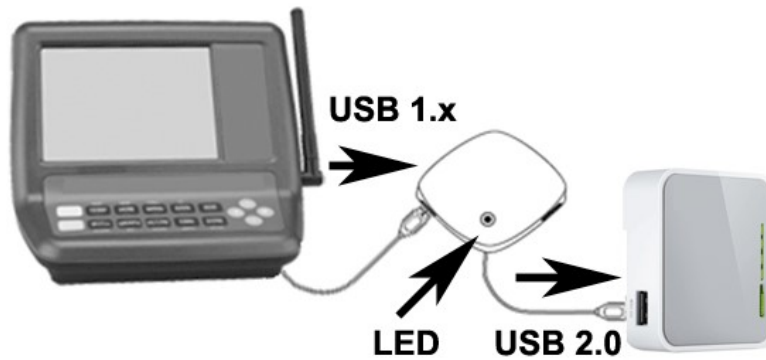

Figure 3
Optional USB Hub/Converter for 1.x Devices. Carefully note the USB Hub output (next to the LED) connects to the WeatherBridge.

3.2 IP Connection

3.2.1 Davis Vantage Pro and VantageVue IP Data Logger

Connect both your VantageVue 6555 IP Data Logger and the WeatherBridge into the same router, as shown in Figure 4.

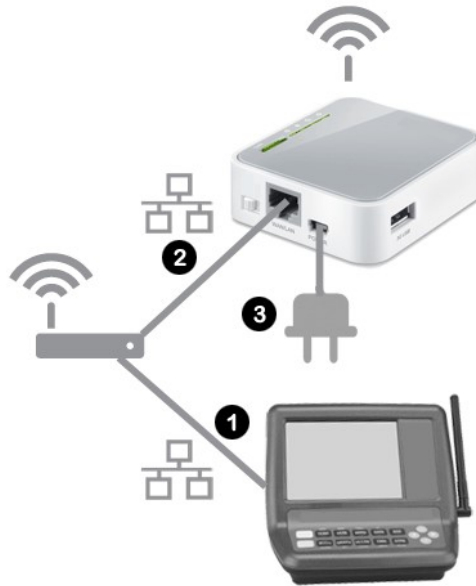

Figure 4

3.2.2 Acurite Internet-Bridge

The Acurite Internet-Bridge can only be used when WeatherBridge is connected to your LAN via WiFi, as it needs the LAN port to be directly connected to the Acurite Internet-Bridge by means of an Ethernet cable. Furthermore, "LAN Bridge" option on the network tab must be enabled to allow the Acurite Internet-Bridge to connect to the Internet as before. WeatherBridge will "sniff" weather data from the TCP traffic, and the Acurite Internet-Bridge data will pass through Meteobridge.

4 IP Addressing (finding the WeatherBridge)

There are several different ways to read the IP address of the WeatherBridge (easiest first):

- Use the Magic IP Finder
- Use a network software scan tool
- Read the blinking Status/Reset Lights
- Write IP address to a USB stick (optional)

4.1 Magic IP Finder

If the WeatherBridge Status light is solid green, it has made a connection to the internet. Simply type the following web address into your computer's web browser, and the MagicIP Finder will find your IP:

<http://magicip.meteobridge.com>

The date and time of the last successful connection will be recorded. Here is an example:

Meteobridge TL-MR3020 (MAC A0:F3:C1:C9:34:EE) with LAN IP 192.168.0.42 at 2013-02-19 20:25:29.

4.2 Software Scan Tool (alternate IP finder)

The WeatherBridge is programmed from the factory for dynamic addressing (or DHCP). This allows you to address the unit from any computer on your network without modifying the IP address.

However, since it is dynamic, you will have to determine the address that was assigned to the unit.

To determine this address, download a free IP scan tool here:

<http://www.advanced-ip-scanner.com>

For Mac and Linux users, visit:

<https://angryip.org/download/>

Select the **Scan** button in the software. After the scan is complete, locate the IP address associated with the Mac Address of the MeteoBridge. The prefix will begin with one of the following:

90:F6:52:xx:xx
A0:F3:C1:xx:xx

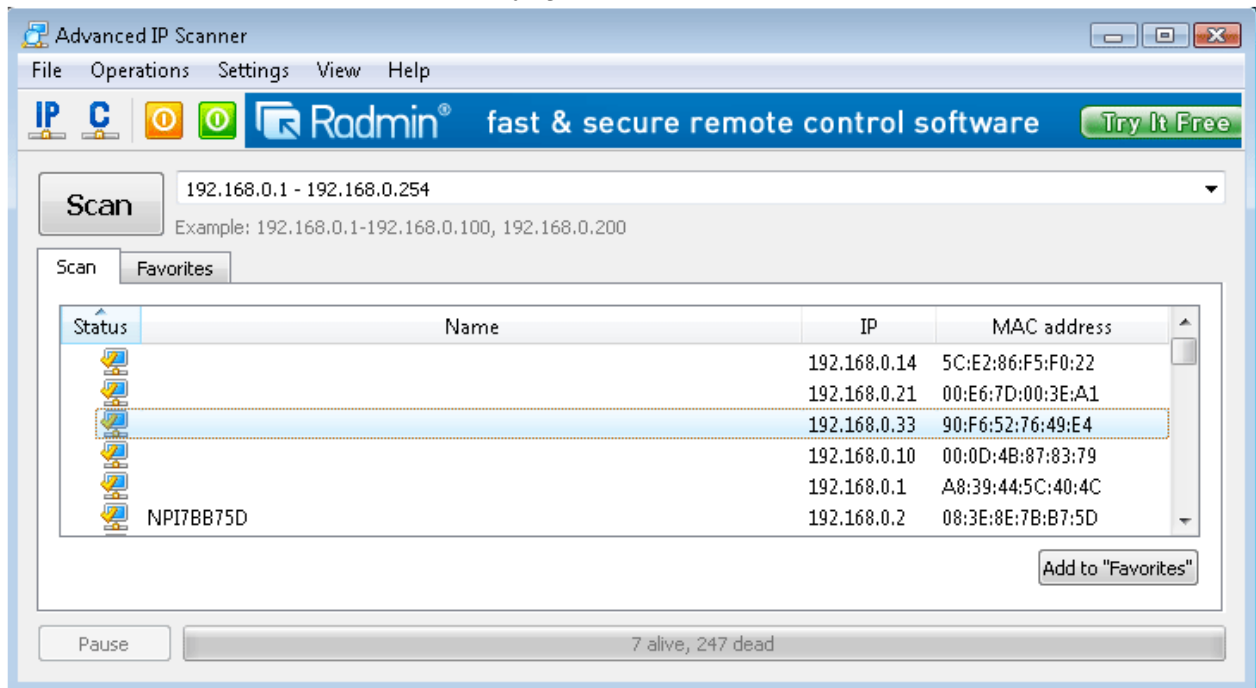

Figure 5

In the example above, type `http://192.168.0.33` into your browser to begin communicating to the MeteoBridge.



4.3 Reading the Blinks from the Status/Reset Light (alternate IP finder)

To read the IP address from the Status/Reset light, wait for the Status/Reset LED to stop blinking (when booting up, it will blink slowly, then quickly, then solid on). This process may take several minutes.

Press the Status/Reset button, then immediately let go to begin. It is helpful to have a paper and pen handy to write down the coded LED response.

The LED will turn off, then start blinking the IP pattern with a combination of medium flashes, separated by long flashes. The medium flashes represent the IP address and the long flash represents the dot separator.

This is best understood with an example:

Example: IP 192.168.10.77

Legend: M = Medium flash, L = Long Flash, _ = LED is OFF

Signal	Comment
_ M _ M _ M _ M _ M _ M _ M _ M _ M _ M _ L	192
_ M _ M _ M _ M _ M _ M _ M _ M _ M _ M _ M _ M _ L	168
_ M _ M _ M _ M _ M _ M _ M _ M _ M _ L	10
M M M M M M M M M M M M M M M M	77

In the example above, type `http://192.168.10.77` into your browser to begin communicating to the MeteoBridge.

4.4 Using USB Stick (alternate IP finder)

A blank USB stick is optional with this package. If the weather station is connected to the USB port, disconnect the weather station and insert the blank USB stick into the WeatherBridge.

Press the Status/Reset button, then immediately let go to begin. Wait for the LED to turn back on, then disconnect the USB stick from the WeatherBridge and insert into the USB port on your computer. Your computer should recognize this file and display the directory.

The following file will be written to the USB stick:

network.log

Open this file with any text editor (such as notepad).

```
Sat Jan 5 00:23:16 UTC 2013
MAC:      xx:xx:xx:xx:xx:xx
LAN IP:   192.168.123.245
```

In the example above, type `http://192.168.123.245` into your browser to begin communicating to the WeatherBridge.

5 Browser Access

Enter the IP address found in the previous step into your web browser.

When prompted for the Username and Password, enter:

Username: meteobridge

Password: meteobridge

6 License

Each WEATHERBRIDGE license comes with 2 years of initial update support. When 2 years have

passed and you still want to have access to the most recent updates, this update license gives you additional 2 years access to updates.

From the Menu tab, select **License**, as shown in Figure 6. Record the **License Key** for warranty purposes.

License Key (case sensitive):



Figure 6
License Key

For additional firmware update support –

[https://order.shareit.com/cart/new?vendorid=200281929&PRODUCT\[300915163\]=1](https://order.shareit.com/cart/new?vendorid=200281929&PRODUCT[300915163]=1)

Firmware Release Log - <https://www.meteobridge.com/wiki/index.php/Forum>

7 System

From the Menu tab, select **System**.

7.1 Network

Record the **Mac Address** for warranty purposes, as shown in Figure 7.

Note the IP address for future reference. This IP address should not change unless changes to the router are made.

MAC Address:

IP Address:

--

7.2 Security (password)

The default username and password is meteobridge and meteobridge. There is likely no need to change this, but you can enter a new username and password. Record the changed username and password here for future reference:

Username: (default is meteobridge)

--

Password: (default is meteobridge)

--

To make the changes permanent, select **Save and Apply**.

7.3 Localization

Enter the appropriate time zone, longitude and latitude, and select **Save and Apply**.

Setup Network
Select Station
Weather Network
Push Services
System
License
Live Data

System

Platform:	TP-LINK TL-MR3020	
RAM:	29364 kB total, 3760 kB free (87% used)	
Software Version:	Linux/OpenWrt 3.3.8 mips, MeteoBridge 1.0	
Uptime:	18 hours, 37 minutes	

Security

New Password:

New Password:

Localization

UTC: 2013-02-20 16:29
 Local Time: 2013-02-20 09:29

Language: English Download Language File

Timezone: America/Phoenix

Latitude: 33.301096 !

Longitude: -112.047423 !

Network

MAC:	90:F6:52:76:49:E4		
LAN IP:	-	WLAN IP:	192.168.0.34
LAN Mask:	-	WLAN Mask:	255.255.255.0
Gateway:	192.168.0.1		
DNS:	127.0.0.1		
WVAN IP:	71.209.169.189		

Messages

```

logger (06.02.2013 21:22:03) : Historical data loaded (18 records) .
logger (06.02.2013 21:22:03) : data logger (version 4.9b, build 1261) started .
logger (06.02.2013 21:22:03) : connect station 0 (00H-1000/3000 via USB HID) .
logger (19.02.2013 21:59:19) : no data synchronisation with station 0 (00H-1000/3000) for
900 seconds, data logger will be restarted.
logger (19.02.2013 21:59:19) : disconnect station 0 (00H-1000/3000) .
logger (19.02.2013 21:59:19) : data logger stopped.
logger (19.02.2013 21:59:21) : Historical data loaded (18 records) .
logger (19.02.2013 21:59:21) : data logger (version 4.9b, build 1261) started.
logger (19.02.2013 21:59:22) : connect station 0 (00H-1000/3000 via USB HID) .
logger (19.02.2013 22:04:02) : child process received timeout signal (14) .
logger (19.02.2013 22:04:02) : data logger stopped.
logger (19.02.2013 22:04:02) : Historical data loaded (18 records) .
logger (19.02.2013 22:04:02) : data logger (version 4.9b, build 1261) started.
logger (19.02.2013 22:04:02) : connect station 0 (00H-1000/3000 via USB HID) .
logger (19.02.2013 22:10:50) : parent process received termination signal (15) .
    
```

Save and Apply
Reboot

Figure 7

8 Setup Network

From the Menu tab, select **Setup Network**

8.1 Type of Connection and Configuring WiFi

The default network connection setting is LAN, DHCP (dynamically assigned IP address).

To connect to your wireless network, select the Wireless LAN option and enter the wireless network settings, as shown in Figure 8.

To convert from LAN to Wireless LAN, select **Save and Apply and Reboot**, and disconnect from your router. The IP address will likely remain the same and can be accessed in a few minutes through your browser.

8.2 IP Address

You can change from DHCP to manually assigning the IP address, as shown in Figure 8 (this is only an example, your network settings will be different). In most cases, you will not need to change the IP address to a static IP on your network.

To convert from DHCP to statically assigned IP address, select **Save and Apply and Reboot**.

The IP address can be accessed in a few minutes through your browser. Wait until the status light on the WeatherBridge transitions from blinking rapidly to a solid.

8.3 Restoring the default IP Address

In the event the IP address cannot be accessed and the status light is blinking rapidly, plug the WeatherBridge into your router, press and hold the status light until it blinks once, then let go. The WeatherBridge will reboot and wait until the status on the WeatherBridge transitions from blinking rapidly to a solid.

8.4 Restoring to Factory Default

To restore the WeatherBridge to factory default, plug the WeatherBridge into your router, press and hold the status light until it blinks five times, then let go. The WeatherBridge will reboot and wait until the status on the WeatherBridge transitions from blinking rapidly to a solid.

8.5 Advanced Network Settings

If you are having issues communicating over your Local Area Network (LAN) or Wireless Area Network (WLAN), we recommend reviewing the following guide:

http://meteobridge.com/wiki/index.php/Setup_Network#Type_Of_Connection

Setup Network | **Select Station** | Weather Network | Push Services | System | License | Live Data

System Message

Wizard: Please visit tab 'Select Station', finalize setup and press 'Save'

Wizard: Please visit tab 'Weather Networks', finalize setup and press 'Save'

Wizard: Please visit tab 'System', finalize setup and press 'save and apply'

Type of Connection

LAN

Wireless LAN

SSID:

WLAN Region:

Encryption:

Mode:

Passphrase:

LAN Bridge: integrate client on Meteobridge's LAN adapter into WLAN

IP Addresses

Receive automatically (DHCP)

Set manually

IP:

Netmask:

Gateway:

DNS:

Advanced Settings

Use Proxy

Server:

Port:

Figure 8

9 Select Station

9.1 Weather Station Type

Reference Figure 9. From the Menu tab, choose **Select Station**.
 Select your weather station type and then **Save**.

9.2 WeatherLinkIP (WLIP)

If you own a Davis Instruments WeatherLinkIP data logger (6555), enter the WLIP address. Otherwise, leave this blank.

Enter the IP and port (separated by a colon) in the "WLIP" input field (example: "192.168.1.222:22222").

This will tell WeatherBridge to connect this station over your LAN/WLAN (in the example on IP 192.168.1.222 at port 22222) and not the USB port.

To obtain the WeatherLink IP settings, you will need to run the WeatherLink software that came with the WeatherLinkIP and select Setup | Communications port to identify the IP address and port number.

9.3 Altitude

Enter your station altitude in meters. The WeatherBridge will automatically calculate the sea-level corrected pressure (or relative pressure) from the measured pressure (or absolute pressure).

To convert feet to meters:

1 foot = 0.3048 meters

Example: I live at 1,000 feet. What is the altitude in meters?

Altitude (meters) = 1,000 feet x 0.3048 meters/foot = 304.8 meters.

Note: Your console relative pressure may be different than the WeatherBridge calculated pressure because of the difference in the methodology of calculating relative or sea-level corrected pressure.

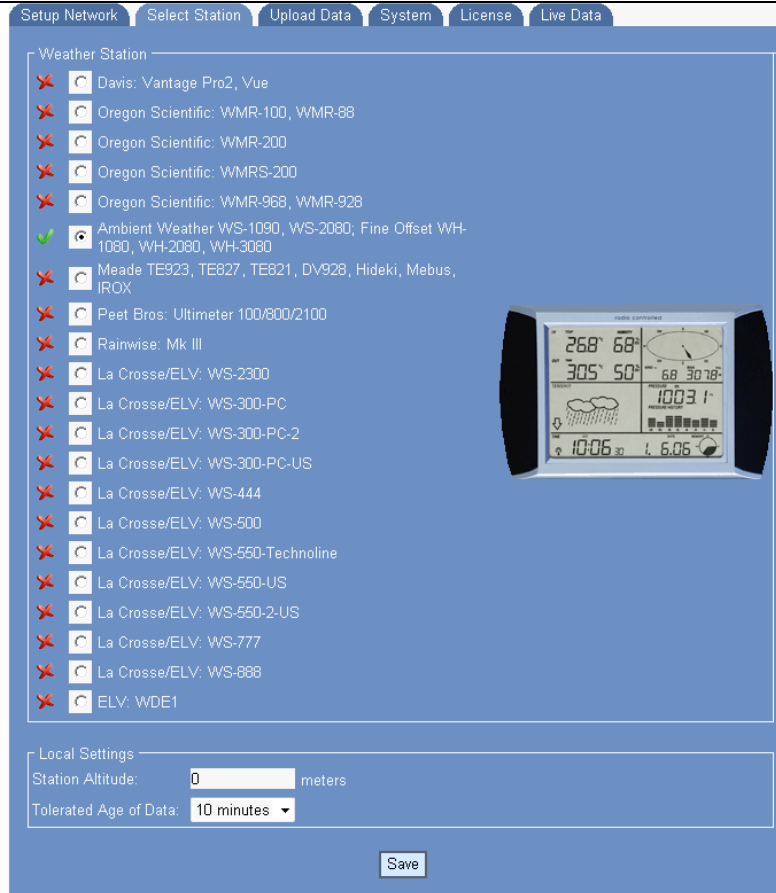

Figure 9

10 Live Data

To view the live data from your weather station, select the Live Data tab. To refresh the data, select the refresh button from your web browser.

The most common issues to no live data are:

- The incorrect weather station is selected
- The weather station USB port has locked up and needs to be reset. To reset your weather station console, reference your weather station user manual. Most consoles require you power down and power up again.

Reference Figure 10 for the typical live data presentation.

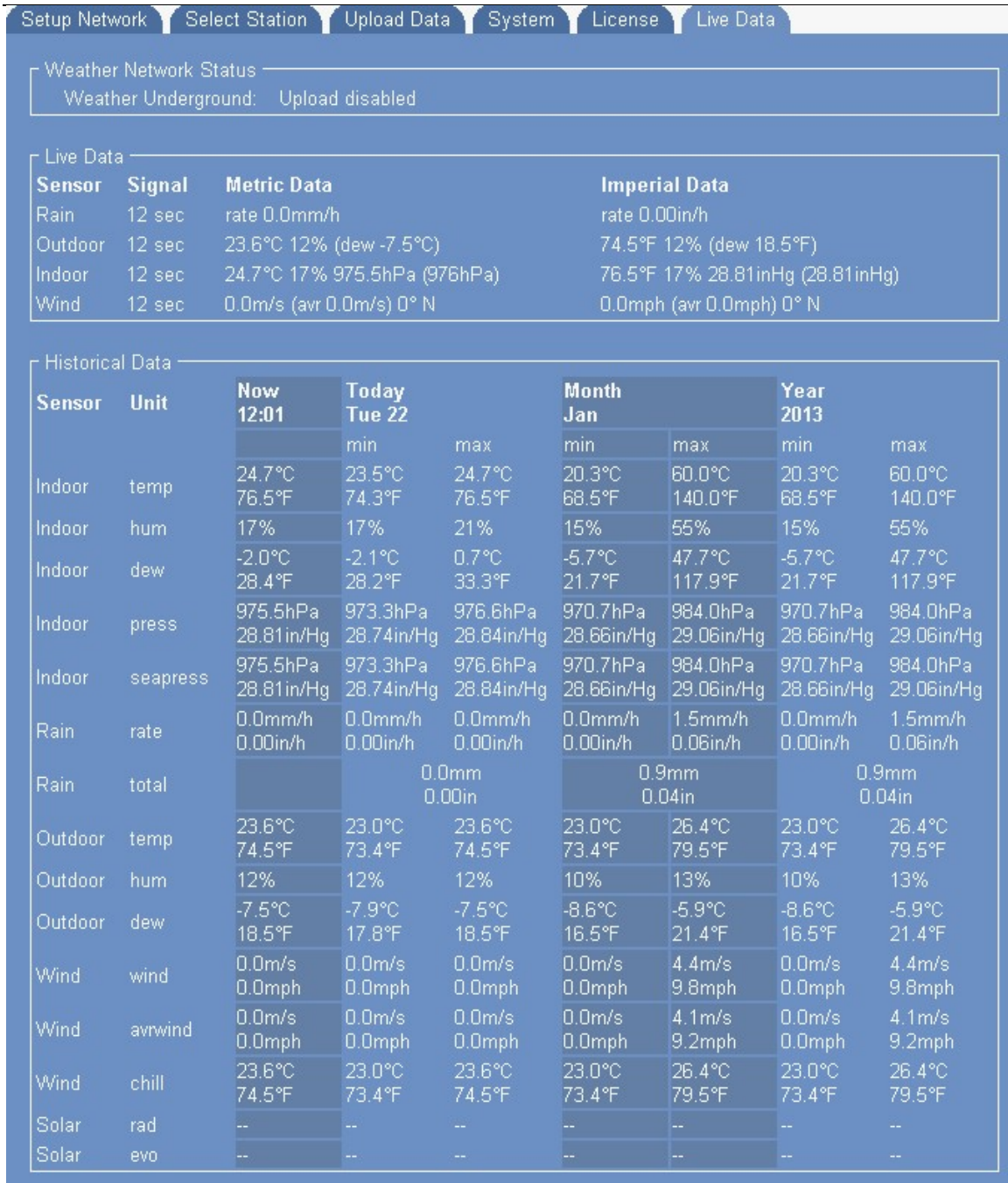

Figure 10
Live Data

11 Weather Network

To upload the live data from your weather station, select the Weather Network tab.

11.1 Wunderground.com (Weather Underground)

To upload data to Wunderground.com, you must first register on the Wunderground.com website. Registration is free.





1. Visit <http://www.wunderground.com/> and select **Join** if you do not have an account.
2. Once registered with Wunderground.com you will need to sign up your station. To get started visit: <http://www.wunderground.com/weatherstation/setup.asp>
3. Once registered, enter your Station ID, Password and Upload Interval in the WeatherBridge fields.
4. Click on the wunderground.com logo to view your current data.





Figure 11

11.2 Other Web Hosting Services

To add more Weather Networks, select the pull down menu bar to select from the list.

Logo	Description	Website	Location
	AWEKAS Weather Map Reporting System	www.awekas.at	Austria
	WeatherBug Backyard	www.weatherbug.com	USA
	WeatherForYou	www.pwsweather.com	USA
	UK Met Office	www.metoffice.gov.uk	UK

Logo	Description	Website	Location
	Windfinder	www.windfinder.com	USA
	Citizen Weather Observation Program	www.wxqa.com	USA
	Open Weather Map	www.openweathermap.org	USA

12 Push Services: Twitter, Email and MySQL

To upload live data to Twitter, send email alerts, write data to your own website, or upload to MySQL, select the Push Services tab, as shown in Figure 12.

For more information on these services, please visit:

http://www.meteobridge.com/wiki/index.php/Push_Services

Setup Network | Select Station | **Weather Networks** | Push Services | System | License | Live Data

System Message
 Wizard: Please visit tab "Setup Network", finalize setup and press "save".
 Wizard: Please visit tab "Select Station", finalize setup and press "save".
 Wizard: Please visit tab "Weather Networks", finalize setup and press "save".
 Wizard: Please visit tab "System", finalize setup and press "save and apply".

Twitter Upload

Upload Interval:

Authentication:

Message Text:



Individual HTTP Upload

Upload Interval:

Success Cond.:

URL:



Individual MYSQL Upload

Upload Interval:

Host:

Database: Port:

SMTP User: Password:

Query:



Individual E-mail Service

Send Interval:

SMTP Host: Port:

User: Password:

To-Addr.: From-Addr.:

Body:



Alarm Service

Alarm Mode:

Raise Condition:

Clear Condition:

Message:

Figure 12

13 AirCam Weather Camera (optional)

The WeatherBridge supports the AirCam and uploads the images directly to Wunderground.com.

The AirCam is available at AmbientWeather.com:

The AirCam connects directly to your network (router or switch) and the WeatherBridge automatically sends the image to Wunderground.com on a schedule.

13.1 Registering your AirCam on Wunderground.com

1. Visit <http://www.wunderground.com/> and select **Join** if you do not have an account.
2. Once registered with Wunderground.com you will need to sign up your AirCam. To get started visit:
<http://www.wunderground.com/webcams/signup.html>
3. Once registered, you will receive a Camera ID.
4. From the WeatherBridge toolbar, select the **Select Station** tab (Figure 13).
5. Enter the IP address and password defined in the AirCam user manual, and select **Initialize Cam** and **Save**.
6. From the WeatherBridge toolbar, select the **Weather Network** tab (Figure 14).
7. Enter the Camera ID and password from your Wunderground.com account.

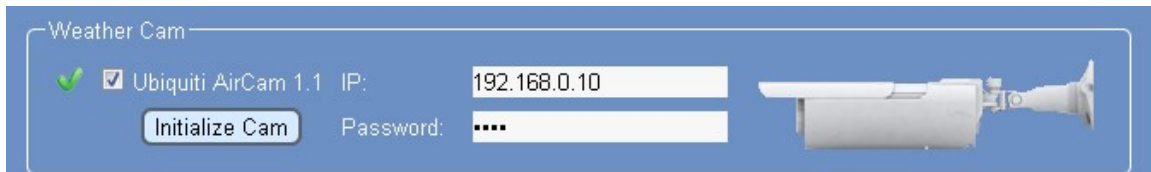

Figure 13

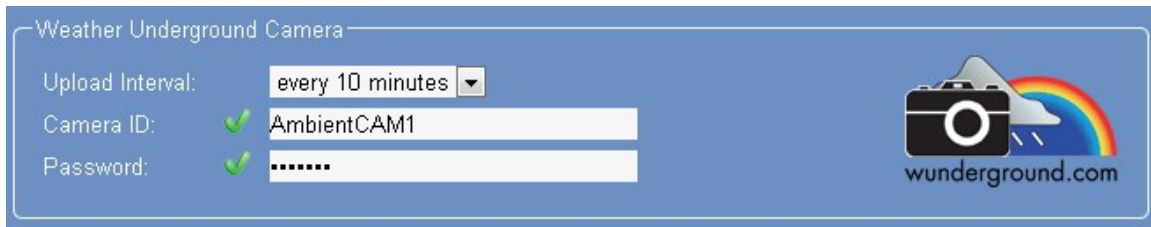

Figure 14

14 More Information

MeteoBridge is a Copyright of smartbedded UG (haftungsbeschränkt), all rights reserved. Please visit www.MeteoBridge.com for online documentation which will give more detail on features and lately added functions.

Note: WeatherBridge can only handle one weather station at a time. Parallel use of multiple weather stations is not supported.

Questions or comments about this manual? We are always striving to improve our documentation. Please send your comments to support@ambientweather.com.

15 Liability Disclaimer

The electrical and electronic wastes contain hazardous substances. Disposal of electronic waste in

wild country and/or in unauthorized grounds strongly damages the environment.

Reading the “User manual” is highly recommended. The manufacturer and supplier cannot accept any responsibility for any incorrect readings and any consequences that occur should an inaccurate reading take place.

This product is designed for personal use as indication of weather conditions. This product is not to be used for medical purposes or for public information.

The specifications of this product may change without prior notice.

This product is not a toy. Keep out of the reach of children.

No part of this manual may be reproduced without written authorization of the manufacturer.

Ambient, LLC WILL NOT ASSUME LIABILITY FOR INCIDENTAL, CONSEQUENTIAL, PUNITIVE, OR OTHER SIMILAR DAMAGES ASSOCIATED WITH THE OPERATION OR MALFUNCTION OF THIS PRODUCT.

16 Warranty Information

Ambient, LLC provides a 1-year limited warranty on this product against manufacturing defects in materials and workmanship.

This limited warranty begins on the original date of purchase, is valid only on products purchased and only to the original purchaser of this product. To receive warranty service, the purchaser must contact Ambient, LLC for problem determination and service procedures.

Warranty service can only be performed by Ambient, LLC. The original dated bill of sale must be presented upon request as proof of purchase to Ambient, LLC.

Your Ambient, LLC warranty covers all defects in material and workmanship with the following specified exceptions: (1) damage caused by accident, unreasonable use or neglect (lack of reasonable and necessary maintenance); (2) damage resulting from failure to follow instructions contained in your owner’s manual; (3) damage resulting from the performance of repairs or alterations by someone other than an authorized Ambient, LLC authorized service center; (4) units used for other than home use (5) applications and uses that this product was not intended.

This warranty covers only actual defects within the product itself, and does not cover the cost of installation or removal from a fixed installation, normal set-up or adjustments, claims based on misrepresentation by the seller or performance variations resulting from installation-related circumstances.