

---

# Ambient Weather WS-0800-IP ObserverBase Wireless Internet Remote Monitoring Weather Station User Manual



## Table of Contents

1.	Introduction.....	1
2.	Quick Start Guide.....	2
3.	Getting Started .....	2
3.1	Parts List.....	2
3.2	Recommend Tools.....	3
3.3	Outdoor Thermo-Hygrometer Sensor Set Up.....	3
3.4	Mounting the Outdoor Thermo-Hygrometer Sensor.....	4
3.5	Indoor Thermo-Hygrometer-Barometer Transmitter.....	5
3.5	Best Practices for Wireless Communication .....	6
3.6	ObserverIP Receiver.....	6
3.6.1	Hardware Requirements.....	6
3.6.2	Software Requirements .....	7
3.6.3	ObserverIP Connections.....	7
3.7	Finding the ObserverIP from your computer.....	8
3.7.1	PC Users.....	8
3.7.2	Mac Users .....	9
3.7.3	Linux Users.....	10
3.7.3	Local Device Network Settings.....	11
3.8	Weather Network Settings.....	12
3.8.1	WeatherUnderground.com .....	13
3.8.2	AmbientWeather.net.....	15
3.8.3	Station Settings.....	18
3.8.4	Live Data.....	20
3.8.5	Calibration.....	21
4.	Updating Firmware .....	23
5.	Glossary of Terms .....	25
6.	Specifications.....	26
6.1	Wireless Specifications .....	26
6.2	Measurement Specifications.....	27
6.3	Power Consumption .....	27
7.	Troubleshooting Guide.....	27
8.	Liability Disclaimer .....	29
9.	FCC Statement.....	29
10.	Warranty Information .....	30

## 1. Introduction

Thank you for your purchase of the Ambient Weather WS-0800-IP ObserverBase Wireless Internet Remote Monitoring Weather Station. The following user guide provides step by step instructions for installation, operation and troubleshooting. To download the latest manual, firmware upgrades and IP Finder Tools, visit:

<http://www.ambientweather.com/observerip.html>

## 2. Quick Start Guide

Although the manual is comprehensive, much of the information contained may be intuitive. In addition, the manual does not flow properly because the sections are organized by components.

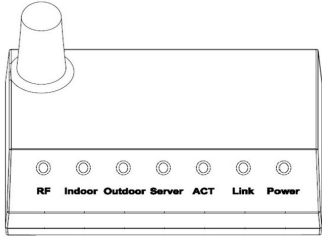
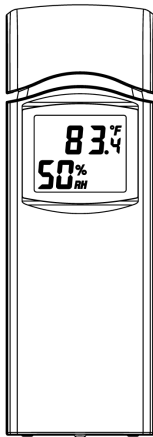
The following Quick Start Guide provides only the necessary steps to install, operate the weather station, and upload to the internet, along with references to the pertinent sections.

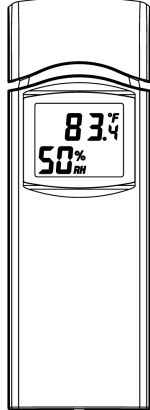




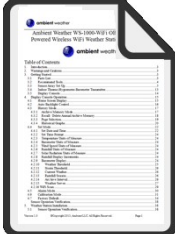
Required		
Step	Description	Section
1	Power up the outdoor thermo-hygrometer sensor	3.3
2	Power up the indoor thermometer-hygrometer-barometer sensor	3.4
3	Power up the ObserverIP, connect to your router and synchronize with the indoor and outdoor sensors	3.6
4	Calibrate the relative pressure to sea-level conditions (local airport) on the ObserverIP module	3.8.5
5	Register and upload to Weather Server	3.8

## 3. Getting Started

The WS-1000-WiFi weather station consists of a ObserverIP receiver, an outdoor thermos-hygrometer sensor, and wireless thermo-hygrometer-barometer.

### 3.1 Parts List


QTY	Item	Image
1	ObserverIP Receiver Dimensions (LxWxH): 3x2x1"	
1	Indoor thermo-hygrometer-barometer transmitter (WH32B) Dimensions (LxWxH): 4.8" x 1.6" x 0.7" (122 x 42 x 18 mm)	

QTY	Item	Image
1	Outdoor thermo-hygrometer transmitter (WH32E) Dimensions (LxWxH): 4.8" x 1.6" x 0.7" (122 x 42 x 18 mm)	
1	Sensor screw (for hanging sensor)	
1	Zip Tie (for hanging sensor)	
1	5V DC Adaptor	
1	Ethernet Cable	
1	User manual	

### 3.2 Recommend Tools

- Precision screwdriver (for small Phillips screw on battery cover door and mounting bracket)
- Drill for mounting bracket

### 3.3 Outdoor Thermo-Hygrometer Sensor Set Up

 **Note:** To avoid permanent damage, please take note of the battery polarity before inserting the batteries.

The outdoor thermometer-hygrometer measures and displays the outdoor temperature and humidity to the ObserverIP receiver.

Remove the battery door on the back of the sensor by sliding off the battery door. Insert two AA batteries as shown in Figure 1, and close the battery door. Note that the temperature and humidity will be displayed on the LCD display.

We recommend lithium batteries for cold weather climates, but alkaline batteries are sufficient for most climates. We do not recommend rechargeable batteries. They have lower voltages, do not operate well at wide temperature ranges, and do not last as long, resulting in poorer reception.

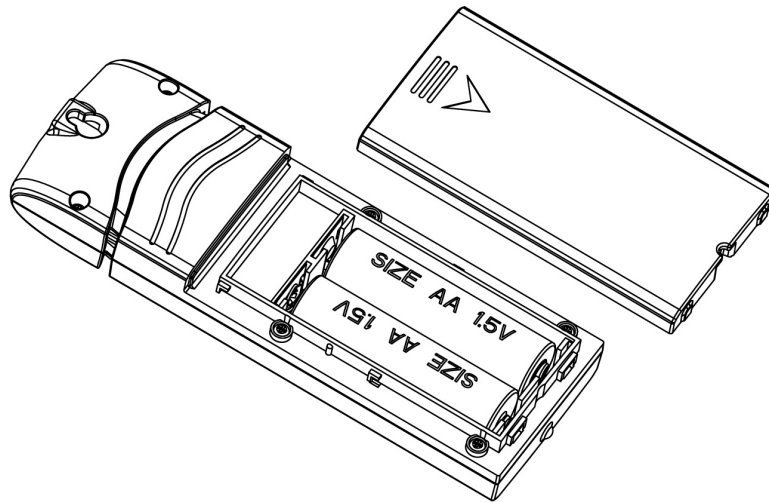
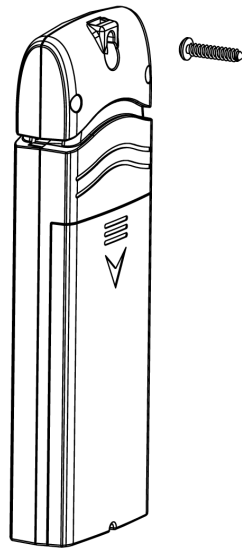


Figure 1

### 3.4 Mounting the Outdoor Thermo-Hygrometer Sensor

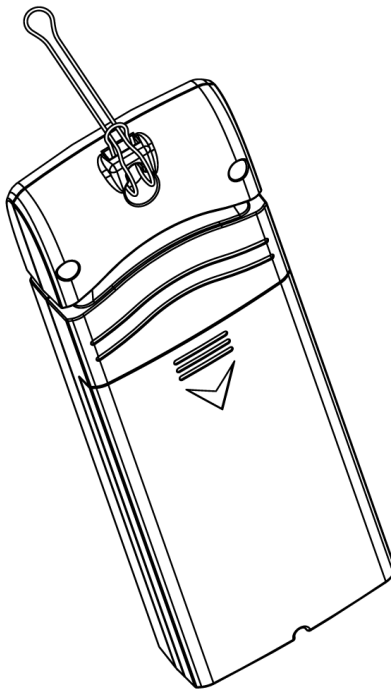
It is recommended you mount the remote sensor on a north facing wall, in a shaded area, at a height at or above the receiver. Direct sunlight and radiant heat sources will result in inaccurate temperature readings. Although the sensor is weatherproof, it is best to mount in a well protected area, such as an eave.

Use a small nail or screw (included) to mount to a vertical surface, as shown in Figure 2.



**Figure 2**


The sensor can also be hung from a nylon zip tie (included) or string (not included).




**Figure 3**

### **3.5 Indoor Thermo-Hygrometer-Barometer Transmitter**

The indoor thermometer, hygrometer and barometer measures and displays the indoor temperature, humidity and pressure and transmits this data to the ObserverIP receiver.


 **Note:** Do not install the thermo-hygrometer-barometer transmitter outside. This will cause errors in the barometric pressure due to large variations in temperature (barometric pressure is temperature compensated for accuracy). Note that pressure readings made inside your home, business, or facility will correspond closely to the actual barometric pressure outside.

 **Note:** The thermo-hygrometer-transmitter transmits directly to the ObserverIP receiver. For best results, place between 5 to 20 feet from the ObserverIP receiver.

 **Note:** To avoid permanent damage, please take note of the battery polarity before inserting the batteries.

Remove the battery door on the back of the sensor by sliding off the battery door. Insert two AA batteries as shown in Figure 1, and close the battery door. Note that the temperature, humidity and barometer will be displayed on the LCD display.

### 3.5 Best Practices for Wireless Communication

 **Note:** To insure proper communication, mount the remote sensor(s) upright on a vertical surface, such as a wall. **Do not lay the sensor flat.**

Wireless communication is susceptible to interference, distance, walls and metal barriers. We recommend the following best practices for trouble free wireless communication.

1. **Electro-Magnetic Interference (EMI).** Keep the ObserverIP receiver several feet away from computer monitors and TVs.
2. **Radio Frequency Interference (RFI).** If you have other 915 MHz devices and communication is intermittent, try turning off these other devices for troubleshooting purposes. You may need to relocate the transmitters or receivers to avoid intermittent communication.
3. **Line of Sight Rating.** This device is rated at 300 feet line of sight (no interference, barriers or walls) but typically you will get 100 feet maximum under most real-world installations, which include passing through barriers or walls.
4. **Metal Barriers.** Radio frequency will not pass through metal barriers such as aluminum siding. If you have metal siding, align the remote and ObserverIP receiver through a window to get a clear line of sight.

The following is a table of reception loss vs. the transmission medium. Each “wall” or obstruction decreases the transmission range by the factor shown below.

Medium	RF Signal Strength Reduction
Glass (untreated)	5-15%
Plastics	10-15%
Wood	10-40%
Brick	10-40%
Concrete	40-80%
Metal	90-100%

### 3.6 ObserverIP Receiver

#### 3.6.1 Hardware Requirements

1. Broadband router

2. An “always-on” connection to the Internet. A high speed DSL or cable internet connection that maintains constant connection to the internet.

### 3.6.2 Software Requirements

An IP scan tool is required to locate the ObserverIP on the network.

**Important Note:** Download ObserverIP tools at the following location:

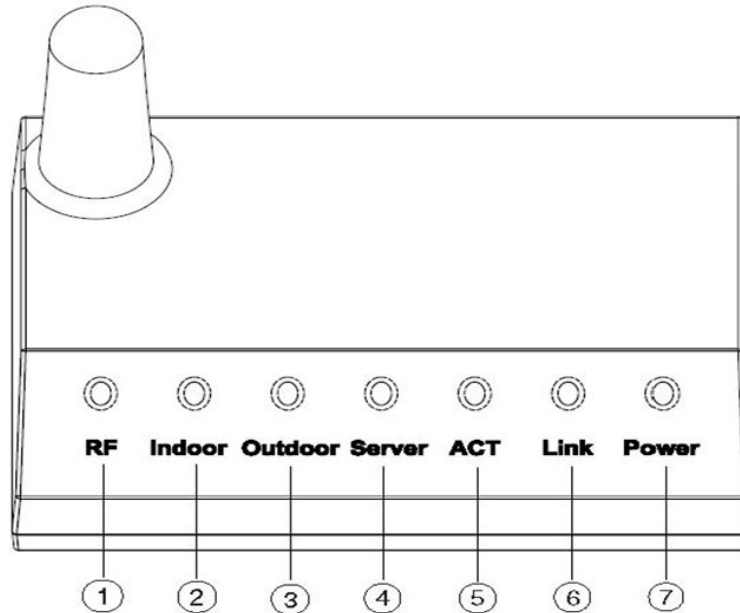
[www.AmbientWeather.com/observerip.html](http://www.AmbientWeather.com/observerip.html)

### 3.6.3 ObserverIP Connections

Connect the ObserverIP receiver power jack to AC power with the power adapter (included), as shown in Figure 5, reference 10.

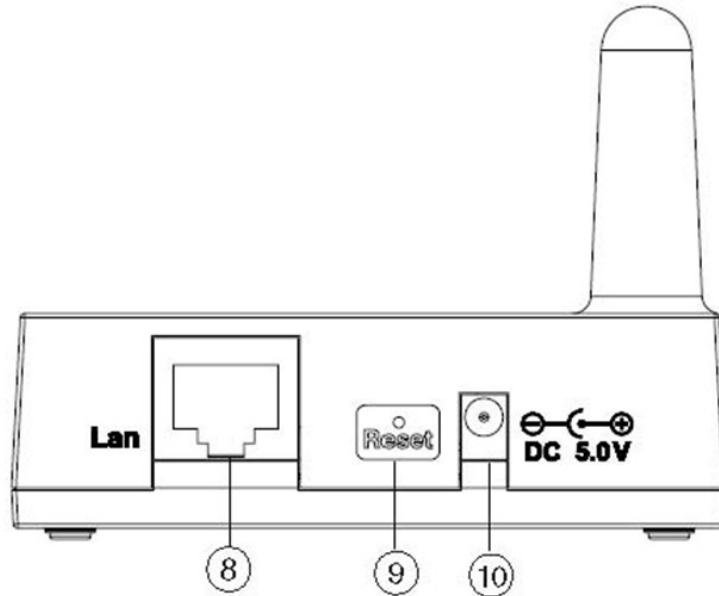
Connect the ObserverIP receiver to your router using the Ethernet cable (included), as shown in Figure 5, reference 8.

Place the indoor and outdoor transmitters about 5 to 10 feet from the ObserverIP receiver and wait several minutes for the remote sensors to synchronize with the receiver. Once synchronized, the Indoor blue LED (Figure 4, reference 2) and Outdoor blue LED (Figure 4, reference 3) will be illuminated.



Ref.	LED	Description
1	RF	On when radio frequency receiver is operating properly
2	Indoor	On when indoor sensor received
3	Outdoor	On when outdoor sensor received
4	Server	On when connected to Wunderground.com® internet hosting service
5	ACT	Flashes when there is internet activity
6	Link	Connected to the Internet (or router)
7	Power	AC Power connected

Figure 4



Ref.	Description
8	LAN connection (connect to router)
9	Reset button
10	AC Power connection

Figure 5

## 3.7 Finding the ObserverIP from your computer

### 3.7.1 PC Users

To find the ObserverIP receiver, launch the IP Tools application downloaded here:

[www.AmbientWeather.com/observerip.html](http://www.AmbientWeather.com/observerip.html)



The HostIP (your computers IP address) will be displayed. Press the **OK** button to continue.

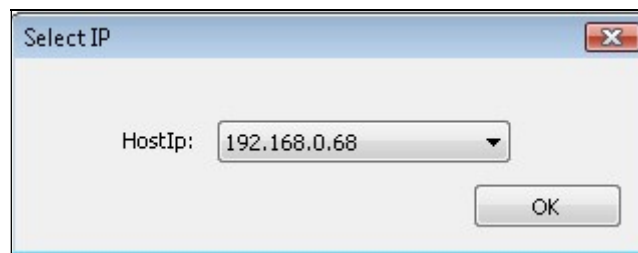
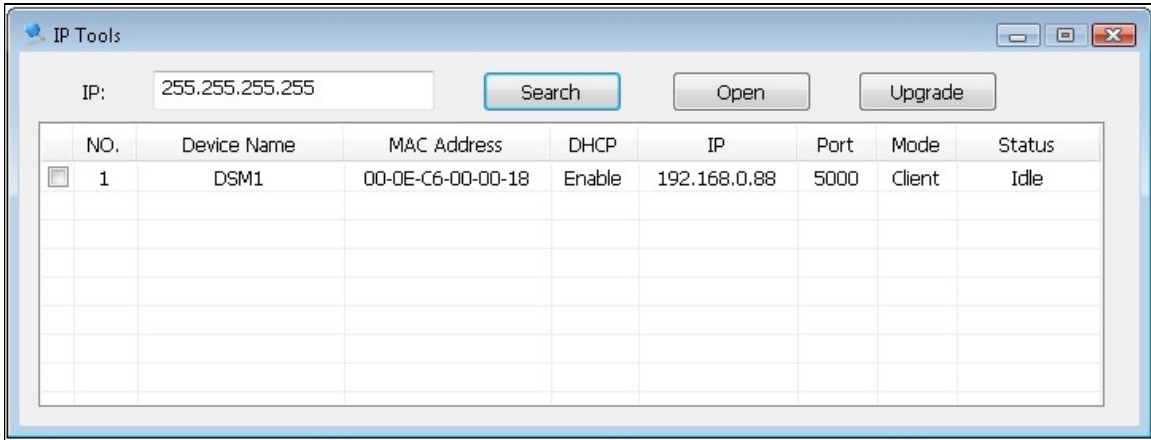


Figure 6

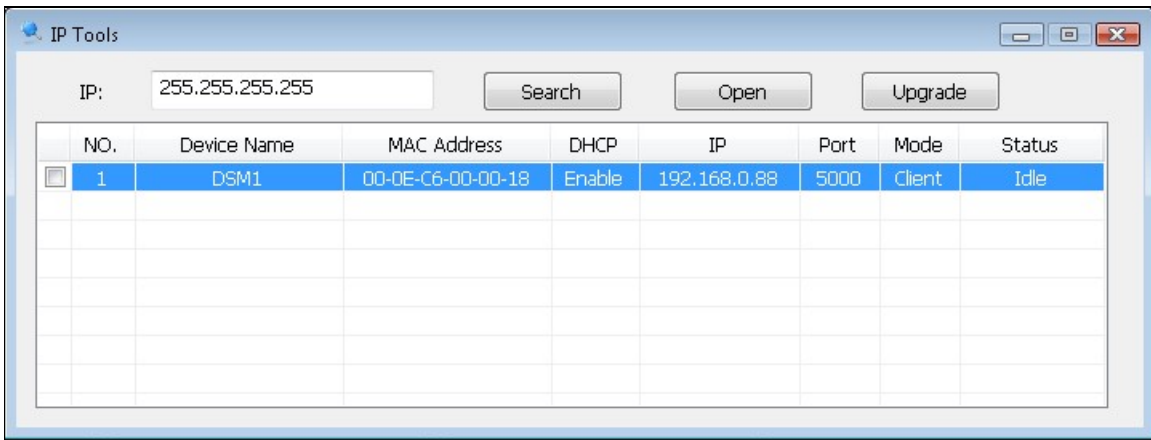
Select the **Search** button to find the ObserverIP on your local area network.



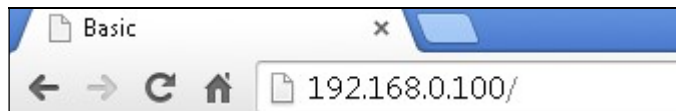


**Figure 7**

Select the ObserverIP module on your network as shown in Figure 8 (the field will be highlighted) and select the **Open** button (or double click this field) to view the ObserverIP module’s webpage within your browser. Alternately, you can type the IP address in your web browser address bar (example, Figure 9):



**Figure 8**



**Figure 9**

You are now communicating directly to the ObserverIP and can proceed to Section 3.7.

### 3.7.2 Mac Users

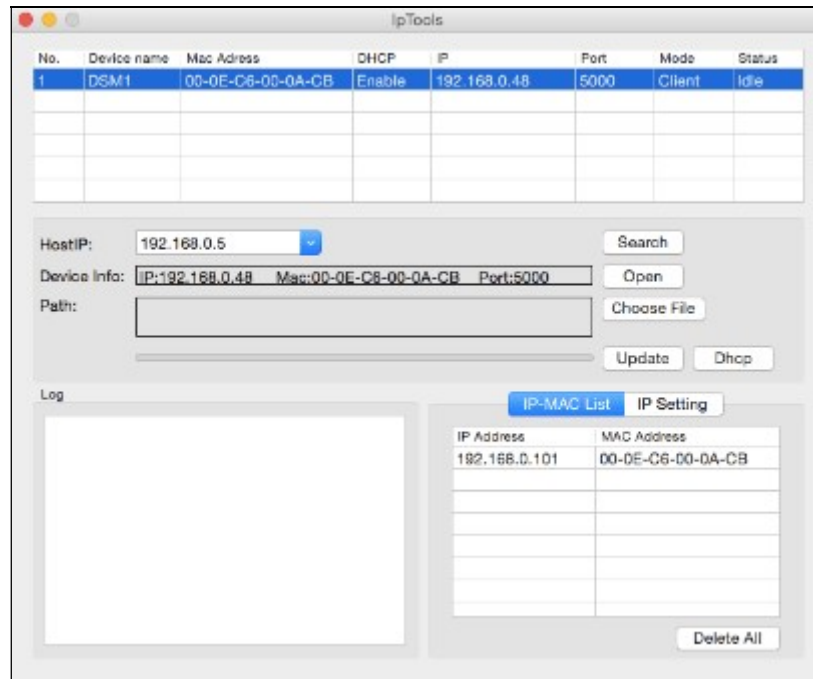
To find the ObserverIP receiver, launch the IP Tools application downloaded here:

[www.AmbientWeather.com/observerip.html](http://www.AmbientWeather.com/observerip.html)

The file is compressed as a zip file and must be extracted to run.

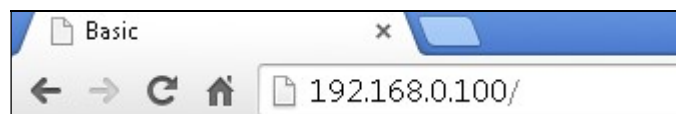


Select the **Search** button to find the ObserverIP on your local area network.



**Figure 10**

Select the ObseverIP module on your network as shown in Figure 10 (the field will be highlighted) and select the **Open** button (or double click this field) to view the ObserverIP module’s webpage within your browser. Alternately, you can type the IP address in your web browser address bar (example, Figure 9):



**Figure 11**

You are now communicating directly to the ObserverIP and can proceed to Section 3.7.

### 5.7.3 Linux Users

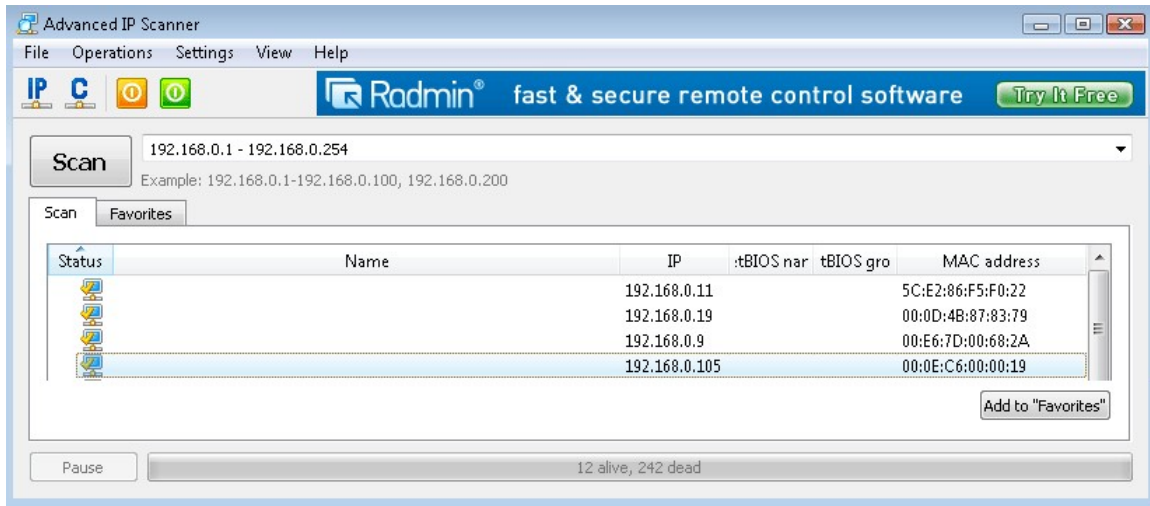
If you use an Apple or Linux operating system, download any commercially available IP scan tool, such as AngryIP Scanner and find the MAC address of the ObserverIP. The MAC address is a unique identifier for internet enabled devices.

The MAC address will be printed on the bottom of the ObseverIP receiver. An example MAC address is 00:0E:C6:00:00:19.

We have included links to free IP Scan Tool applications here:

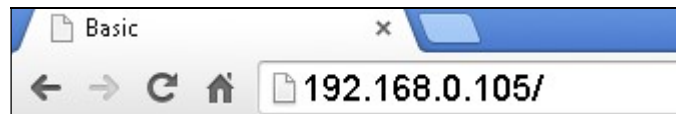
[www.AmbientWeather.com/observerip.html](http://www.AmbientWeather.com/observerip.html)

Figure 12 shows typical scan results. Locate the IP address of the ObserverIP by cross referencing the Mac address. In the example below, the IP address is 192.168.0.105.



**Figure 12**

Type the IP address you located from the IP Scan Tool into your web browser (example, Figure 13):



**Figure 13**

You are now communicating directly to the ObserverIP and can proceed to Section 3.7.

### 3.7.3 Local Device Network Settings

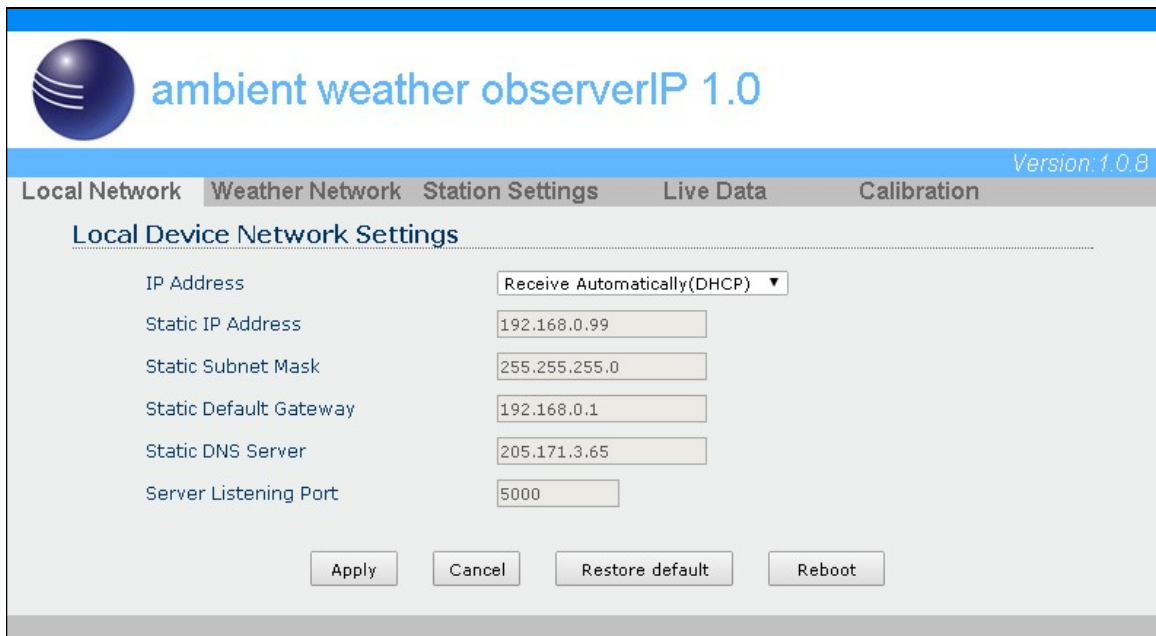
From your web browser, access the ObserverIP from the IP address obtained in the previous section.

Select the **Local Network** tab to program the local network settings. Reference Figure 14:

1. **IP Address.** The default setting is receive automatically (DCHP), which is recommended. The network will assign an IP address. To statically assign an IP address, select **Static** from the pull down menu. This will prevent the IP address from changing each time you power up the ObserverIP receiver.
2. **Static IP Address.** If Static is selected as the IP address, enter the IP address you wish to access the ObserverIP device.
3. **Static Subnet Mask.** Default is 255.255.255.0. This should not be changed unless you are familiar with networking and subnet masking.
4. **Static Default Gateway.** This is typically the IP address of your router.
5. **Static DNS Server.** This is your DNS Server setting based on your router connection.
6. **Server Listening Port.** Default is 5000. Enter an integer between 1024 – 65535.

If you made any Static IP Address changes (not recommended), to confirm these changes, select **Apply** and **Reboot**.

**Note:** If you incorrectly set the static IP settings and can no longer access the ObserverIP, press the reset button on the back of the module.



**ambient weather observerIP 1.0** Version: 1.0.8

Local Network **Weather Network** Station Settings Live Data Calibration

**Local Device Network Settings**

IP Address

Static IP Address

Static Subnet Mask

Static Default Gateway

Static DNS Server

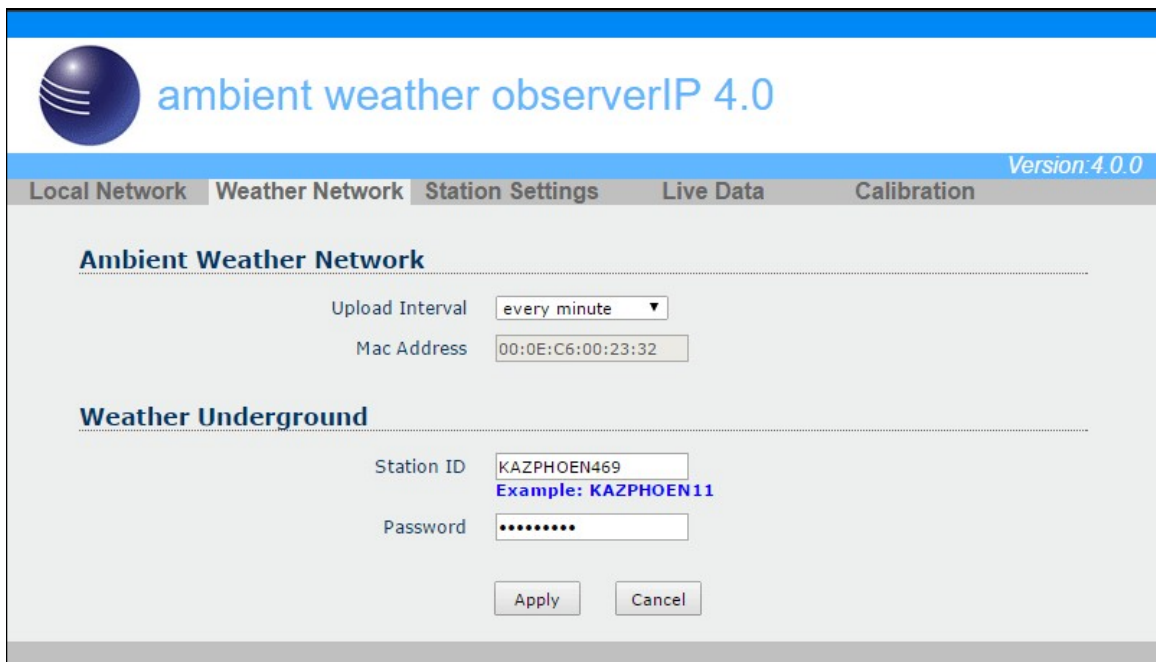
Server Listening Port

Apply Cancel Restore default Reboot

**Figure 14**

### 3.8 Weather Network Settings

Select the **Weather Network** tab to program the Weather Underground station settings and Ambient Weather Network settings (AmbientWeather.net requires firmware Version 4.0 or greater). . Reference Figure 15:



**ambient weather observerIP 4.0** Version: 4.0.0

Local Network **Weather Network** Station Settings Live Data Calibration

**Ambient Weather Network**

Upload Interval

Mac Address

**Weather Underground**

Station ID   
Example: **KAZPHOEN11**

Password

Apply Cancel

**Figure 15**

### 3.8.1 WeatherUnderground.com

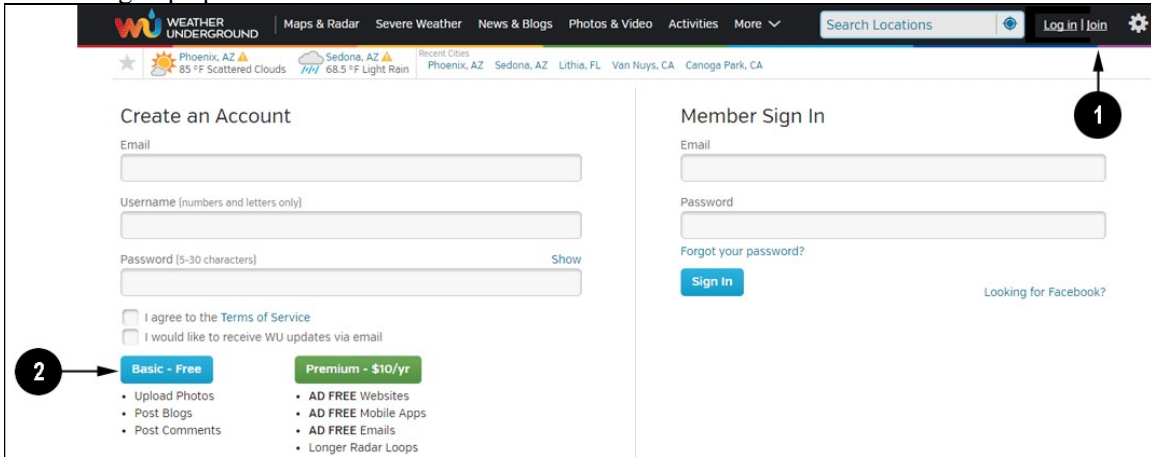
Enter the Station ID and Station Key obtained from Wunderground.com®. Select the **Apply** button to confirm changes.

#### 3.8.1.1 Creating a WeatherUnderground.com Account



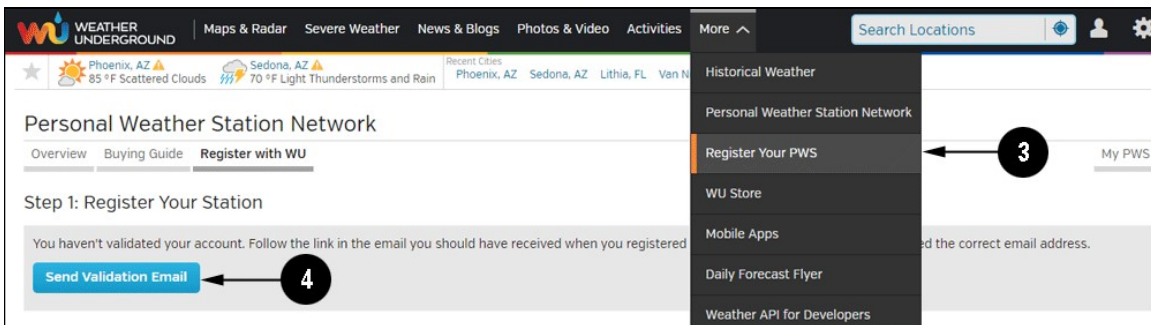
**Note: How to create a Wunderground.com® account and station ID.**

1. Visit [www.Wunderground.com](http://www.Wunderground.com) and select the **Join** link at the top of the page. Select the **Free** sign up option.



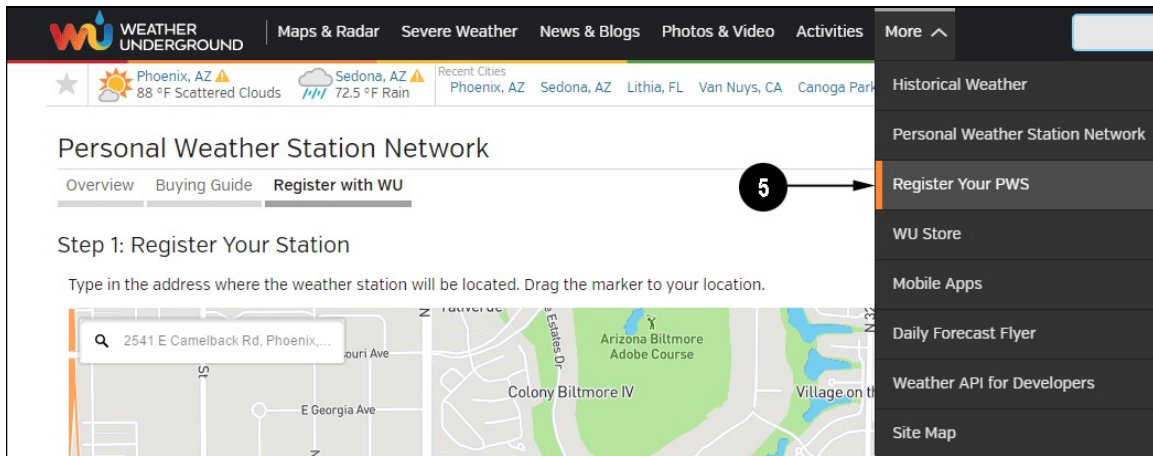
**Figure 16**

2. Select **More | Register Your PWS**.
3. Click **Send Validation Email**. Respond to the validation email from Wunderground (it may take a few minutes).



**Figure 17**

4. Select More | Register Your PWS again and enter all of the information requested.

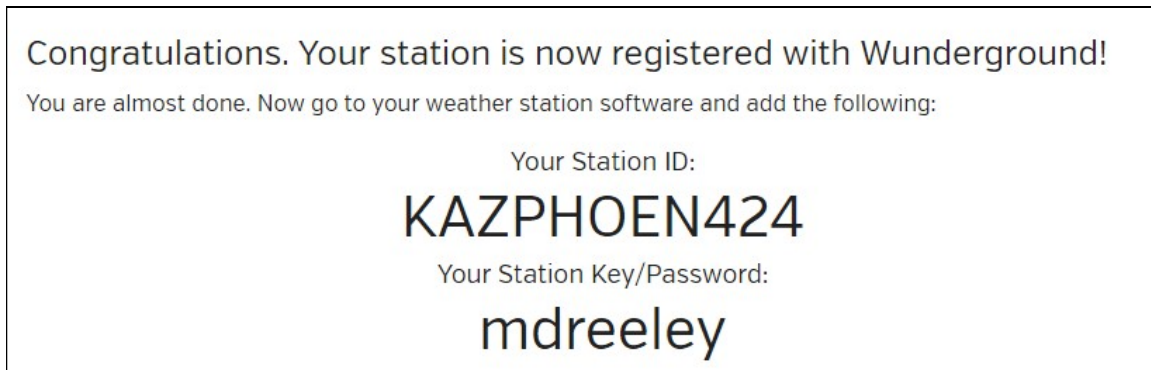


**Figure 18**

5. After registering your station, make a note of the following:
- Station ID
  - Station Key / Password

Enter the Station ID (ID), Station Key (Password) into the ObserverIP Weather Network Panel (Figure 15).

Figure 19 is an example, and your station ID and password will be different.



**Figure 19**

**Note:** Your station ID will have the form: KSSCCCC###, where K is for USA station (I for international), SS is your state, CCCC is your city and ### is the station number in that city.

In the example above, KAZPHOEN424 is in the USA (K), State of Arizona (AZ), City of Phoenix (PHOEN) and #424.

### 3.8.1.2 Viewing your Data on Wunderground.com

There are several ways to view your data on Wunderground:

#### 3.8.1.2.1 Web Browser

Visit:

<http://www.wunderground.com/personal-weather-station/dashboard?ID=STATIONID>

where **STATIONID** is your personal station ID (example, KAZSEDON12).

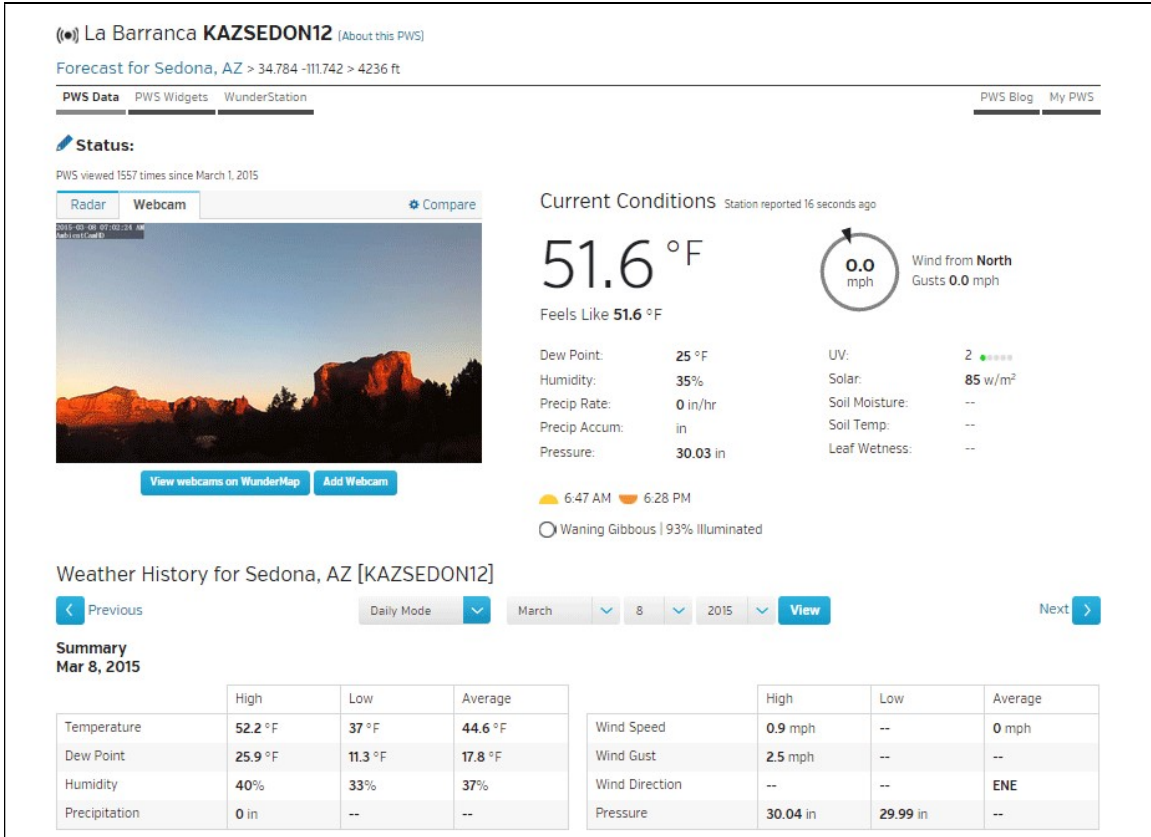


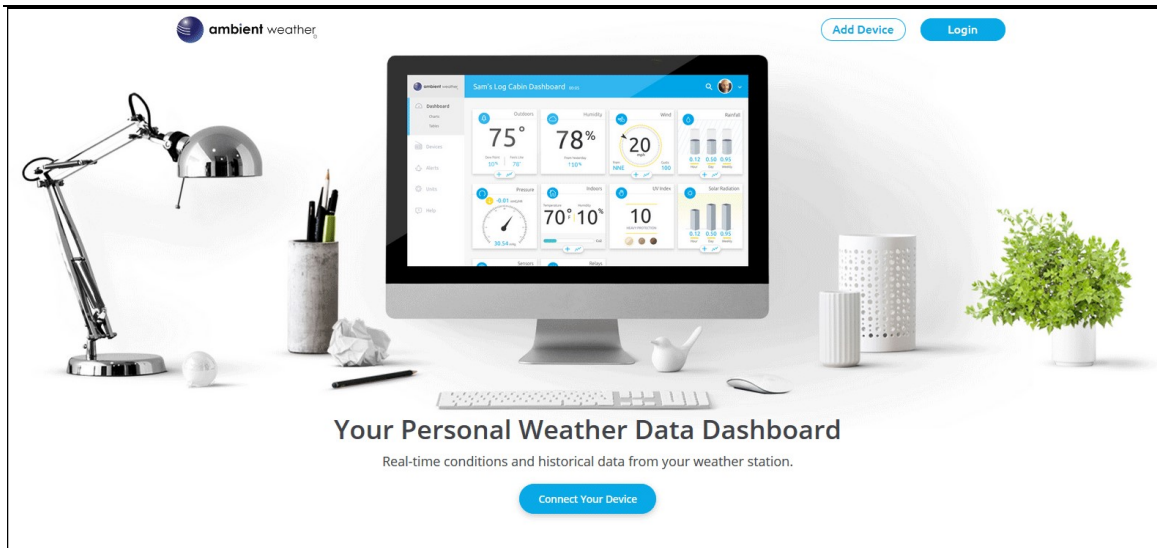
Figure 20

### 3.8.2 AmbientWeather.net

Reference Figure 15. Enter and update schedule and select **Apply**. Make a note of the MAC address. It will be required when you sign up at AmbientWeather.net.

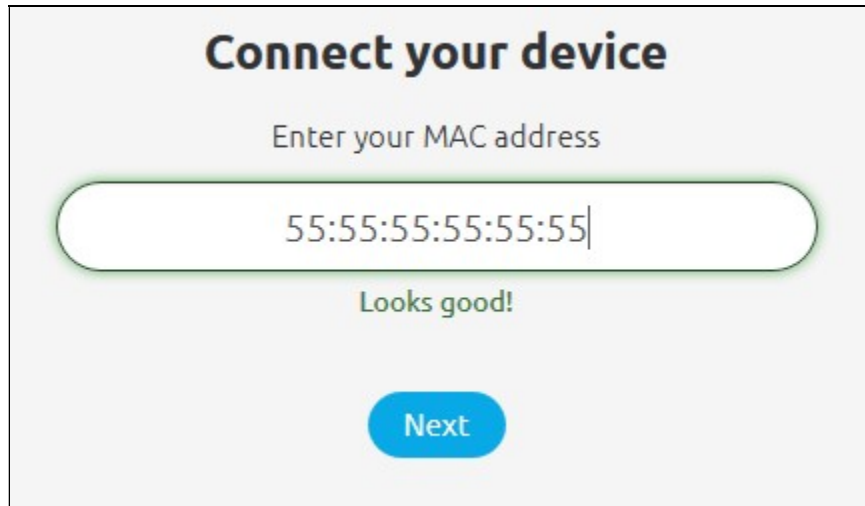
#### 3.8.2.1 Creating an AmbientWeather.net Account

Visit: [www.AmbientWeather.net](http://www.AmbientWeather.net) to create an account and select Add Device, as shown in Figure 21.



**Figure 21**

Next, enter the MAC address found on your IP Module Weather Network Panel (Figure 15), as shown in Figure 22. Note that this is an example only and your MAC address will be different.



**Connect your device**

Enter your MAC address

55:55:55:55:55:55

Looks good!

Next

**Figure 22**

Register an account on AmbientWeather.net (email address and password).

Once registered, select the dashboard to view your data, as shown in Figure 23.



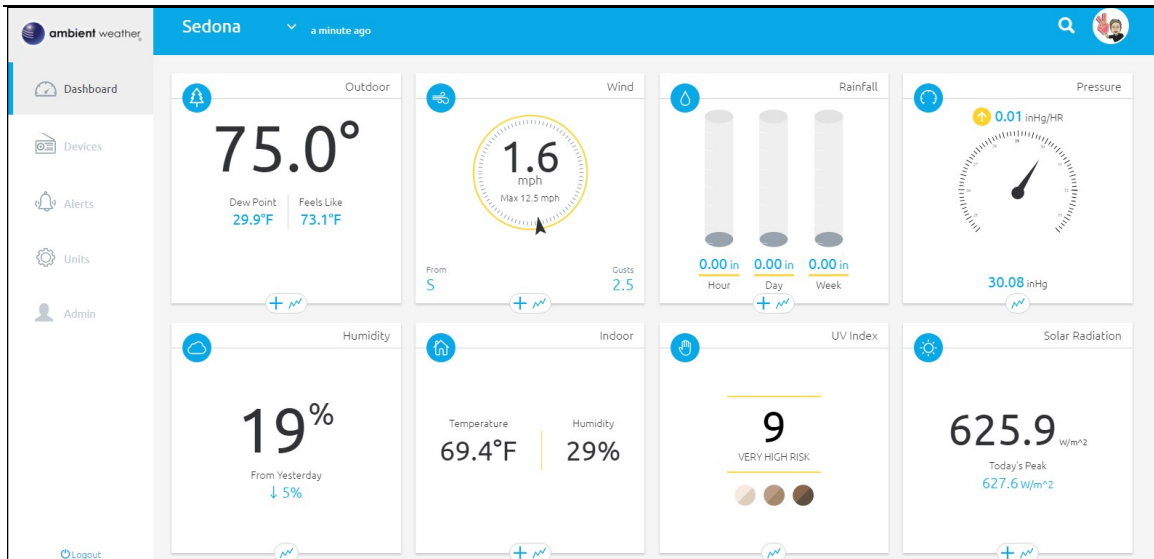


Figure 23

AmbientWeather.net is a responsive design and mobile friendly, so there is no need for a mobile app. Simply open your mobile devices web browser, browse to AmbientWeather.net, and bookmark your dashboard. If you save the bookmark to your desktop, it will automatically save the Ambient Weather icon, as shown in Figure 24.

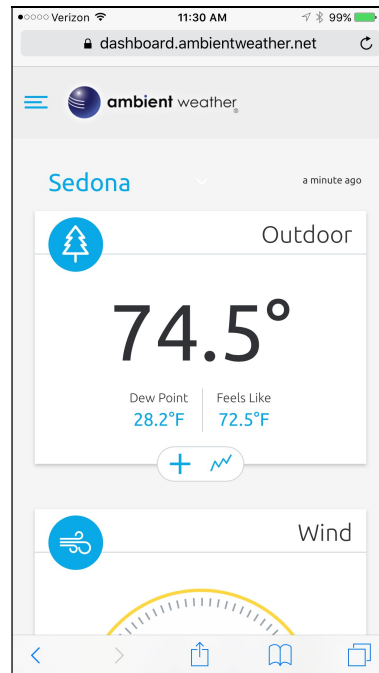
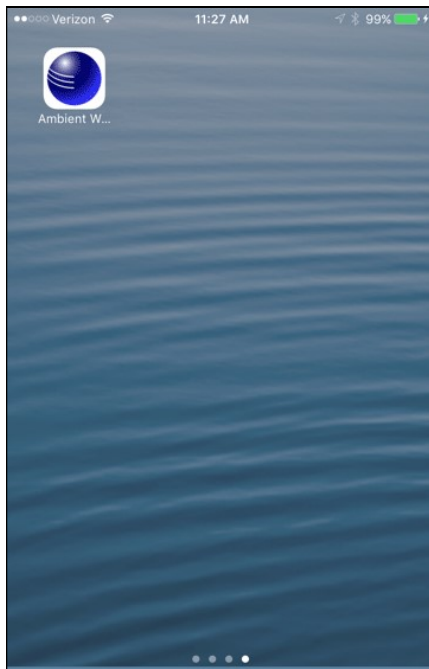


Figure 24

### 3.8.2.2 IFTTT

The AmbientWeather.net service connects to IFTTT, the platform that allows devices and services to work together seamlessly.

Here are a few things you can do with IFTTT:

- Turn off your Rachio sprinklers when it rains, there is too much wind, or below freezing.
- Close your Hunter blinds when the sun is too intense.
- Close your garage door when it is too windy.
- Blink your hue lights when it starts raining.
- Connect to other web services, such as Gmail, Facebook, Instagram, or Pinterest.

For more information on IFTTT and how it can work for you, visit:

[https://ifttt.com/ambient\\_weather](https://ifttt.com/ambient_weather)

### **3.8.3 Station Settings**

Select **Apply** to confirm any of the changes in this section.

#### **3.8.3.1 Wireless Transmitter Settings**

**Weather Station Model Number:** Enter your weather station model number WS-0800-IP.

#### **3.8.3.2 Time Zone Setting**

Enter your local time zone and daylight Savings Time.

The following table provides times zones throughout the world. Locations in the eastern hemisphere are positive, and locations in the western hemisphere are negative.

Hours from GMT	Time Zone	Cities
-12	IDLW: International Date Line West	---
-11	NT: Nome	Nome, AK
-10	AHST: Alaska-Hawaii Standard CAT: Central Alaska HST: Hawaii Standard	Honolulu, HI
-9	YST: Yukon Standard	Yukon Territory
-8	PST: Pacific Standard	Los Angeles, CA, USA
-7	MST: Mountain Standard	Denver, CO, USA
-6	CST: Central Standard	Chicago, IL, USA
-5	EST: Eastern Standard	New York, NY, USA
-4	AST: Atlantic Standard	Caracas
-3	---	São Paulo, Brazil
-2	AT: Azores	Azores, Cape Verde Islands
-1	WAT: West Africa	---
0	GMT: Greenwich Mean WET: Western European	London, England
1	CET: Central European	Paris, France
2	EET: Eastern European	Athens, Greece
3	BT: Baghdad	Moscow, Russia
4	---	Abu Dhabi, UAE
5	---	Tashkent
6	---	Astana
7	---	Bangkok
8	CCT: China Coast	Beijing
9	JST: Japan Standard	Tokyo
10	GST: Guam Standard	Sydney
11	---	Magadan
12	IDLE: International Date Line East NZST: New Zealand Standard	Wellington, New Zealand

### 3.8.3.3 Daylight Savings Time

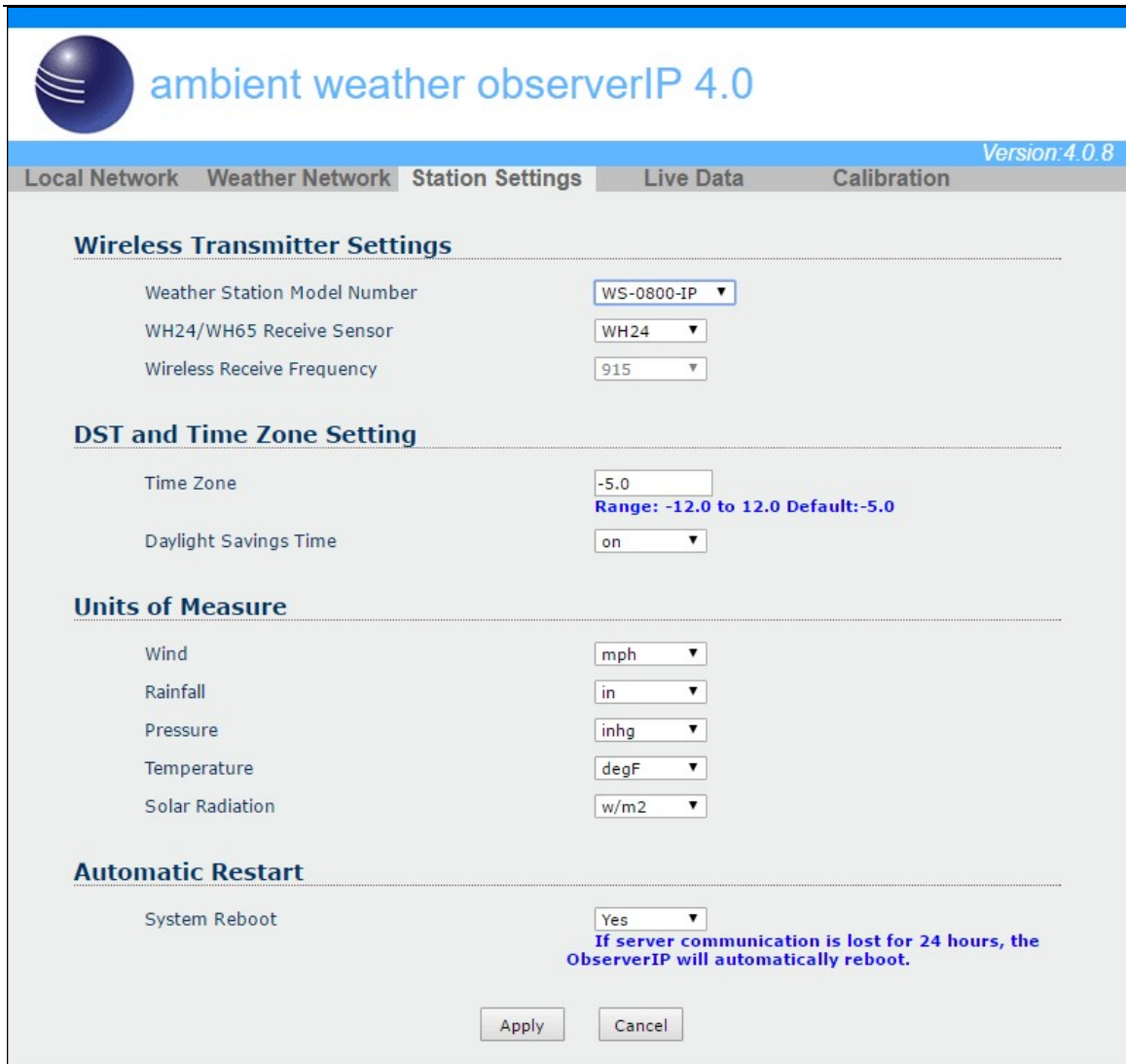
Enter **off** if you live in Hawaii or Arizona, where DST is not observed. Enter **on** if you live anywhere else, even if you are currently observing standard time.

### 3.8.3.4 Units of Measure

Enter your preferred units of measure for each parameter.

### 3.8.3.5 Automatic Restart

Set System Reboot to Yes, and the ObserverIP module will restart if communication is lost for 24 hours, ideal for remote applications where the module cannot be accessed.



**ambient weather observerIP 4.0** Version: 4.0.8

Local Network Weather Network **Station Settings** Live Data Calibration

---

**Wireless Transmitter Settings**

Weather Station Model Number

WH24/WH65 Receive Sensor

Wireless Receive Frequency

---

**DST and Time Zone Setting**

Time Zone   
**Range: -12.0 to 12.0 Default: -5.0**

Daylight Savings Time

---

**Units of Measure**

Wind

Rainfall

Pressure

Temperature

Solar Radiation

---

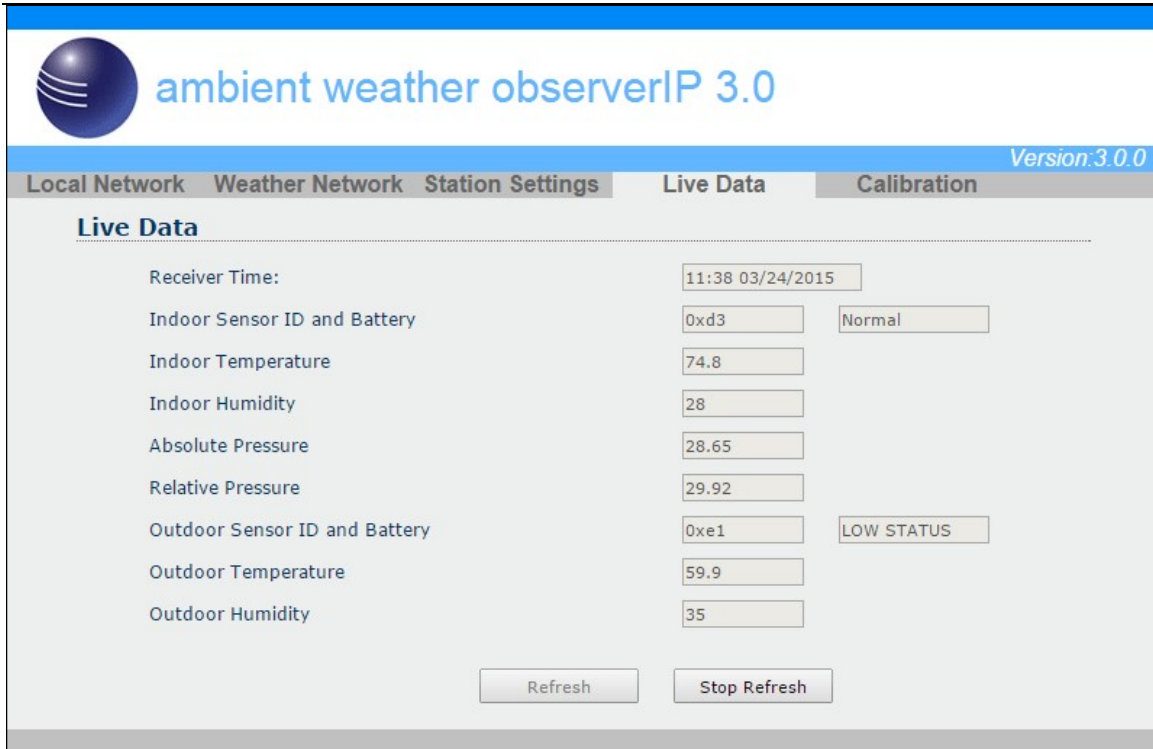
**Automatic Restart**

System Reboot   
**If server communication is lost for 24 hours, the ObserverIP will automatically reboot.**

Figure 25

### 3.8.4 Live Data

Select the **Live Data** tab to view your live data from the weather station. To freeze the live data updates, select the **Stop Refresh** button.



**ambient weather observerIP 3.0** Version: 3.0.0

Local Network Weather Network Station Settings **Live Data** Calibration

**Live Data**

Receiver Time:	<input type="text" value="11:38 03/24/2015"/>
Indoor Sensor ID and Battery	<input type="text" value="0xd3"/> <input type="text" value="Normal"/>
Indoor Temperature	<input type="text" value="74.8"/>
Indoor Humidity	<input type="text" value="28"/>
Absolute Pressure	<input type="text" value="28.65"/>
Relative Pressure	<input type="text" value="29.92"/>
Outdoor Sensor ID and Battery	<input type="text" value="0xe1"/> <input type="text" value="LOW STATUS"/>
Outdoor Temperature	<input type="text" value="59.9"/>
Outdoor Humidity	<input type="text" value="35"/>

**Figure 26**

### 3.8.5 Calibration

Select the Calibration tab to view your calibration data from the weather station. Select the **Apply** button to confirm changes.

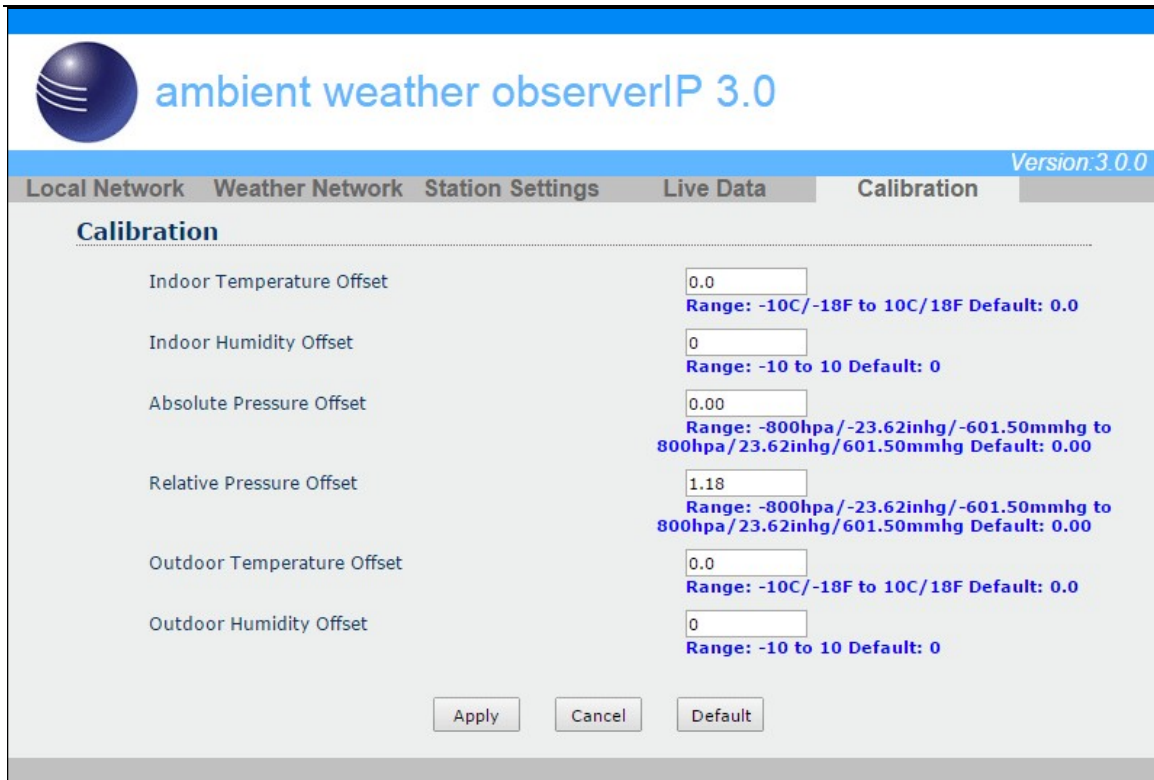
Calibration of most parameters is not required, with the exception of Relative Pressure, which must be calibrated to sea-level to account for altitude effects. For more information on sea-level pressure calibration, please reference note (3) below.

#### 3.8.5.1 Relative Barometric Pressure Calibration Example

The following is an example of calibrating the relative pressure. Your results will vary.

1. The local relative pressure from TV, the newspaper or the internet for the official station in your area is 30.12 inHg.
2. From the Live Data panel, your absolute pressure (measured, and not corrected to sea-level) reads 28.90 inHg.
3. Reference Figure 27. Enter the following offset in the Calibration panel for Relative Pressure Offset:

$$\text{Relative Pressure Offset} = 30.12 - 28.90 = \mathbf{1.22}$$



**Figure 27**

Parameter	Type of Calibration	Default	Typical Calibration Source
Temperature	Offset	Current Value	Red Spirit or Mercury Thermometer (1)
Humidity	Offset	Current Value	Sling Psychrometer (2)
ABS Barometer	Offset	Current Value	Calibrated laboratory grade barometer
REL Barometer	Offset	Current Value	Local airport (3)

- (1) Temperature errors can occur when a sensor is placed too close to a heat source (such as a building structure, the ground or trees).

To calibrate temperature, we recommend a mercury or red spirit (fluid) thermometer. Bi-metal (dial) and digital thermometers (from other weather stations) are not a good source and have their own margin of error. Using a local weather station in your area is also a poor source due to changes in location, timing (airport weather stations are only updated once per hour) and possible calibration errors (many official weather stations are not properly installed and calibrated).

Place the sensor in a shaded, controlled environment next to the fluid thermometer, and allow the sensor to stabilize for 48 hours. Compare this temperature to the fluid thermometer and adjust the ObserverIP receiver to match the fluid thermometer.

- (2) Humidity is a difficult parameter to measure electronically and drifts over time due to

contamination. In addition, location has an adverse affect on humidity readings (installation over dirt vs. lawn for example).

Official stations recalibrate or replace humidity sensors on a yearly basis. Due to manufacturing tolerances, the humidity is accurate to  $\pm 5\%$ . To improve this accuracy, the indoor and outdoor humidity can be calibrated using an accurate source, such as a sling psychrometer.


- (3) The ObserverIP receiver displays two different pressures: absolute (measured) and relative (corrected to sea-level).

To compare pressure conditions from one location to another, meteorologists correct pressure to sea-level conditions. Because the air pressure decreases as you rise in altitude, the sea-level corrected pressure (the pressure your location would be at if located at sea-level) is generally higher than your measured pressure.

Thus, your absolute pressure may read 28.62 inHg (969 mb) at an altitude of 1000 feet (305 m), but the relative pressure is 30.00 inHg (1016 mb).

The standard sea-level pressure is 29.92 in Hg (1013 mb). This is the average sea-level pressure around the world. Relative pressure measurements greater than 29.92 inHg (1013 mb) are considered high pressure and relative pressure measurements less than 29.92 inHg are considered low pressure.

To determine the relative pressure for your location, locate an official reporting station near you (the internet is the best source for real time barometer conditions, such as Weather.com or Wunderground.com®), and set your weather station to match the official reporting station.

 **Note:** The purpose of calibration is to fine tune or correct for any sensor error associated with the devices margin of error. Errors can occur due to electronic variation (example, the temperature sensor is a resistive thermal device or RTD, the humidity sensor is a capacitance device), mechanical variation, or degradation (contamination of sensors).

Calibration is only useful if you have a known calibrated source you can compare it against, and is optional. This section discusses practices, procedures and sources for sensor calibration to reduce manufacturing and degradation errors. Do not compare your readings obtained from sources such as the internet, radio, television or newspapers. The purpose of your weather station is to measure conditions of your surroundings, which vary significantly from location to location.

## 4. Updating Firmware

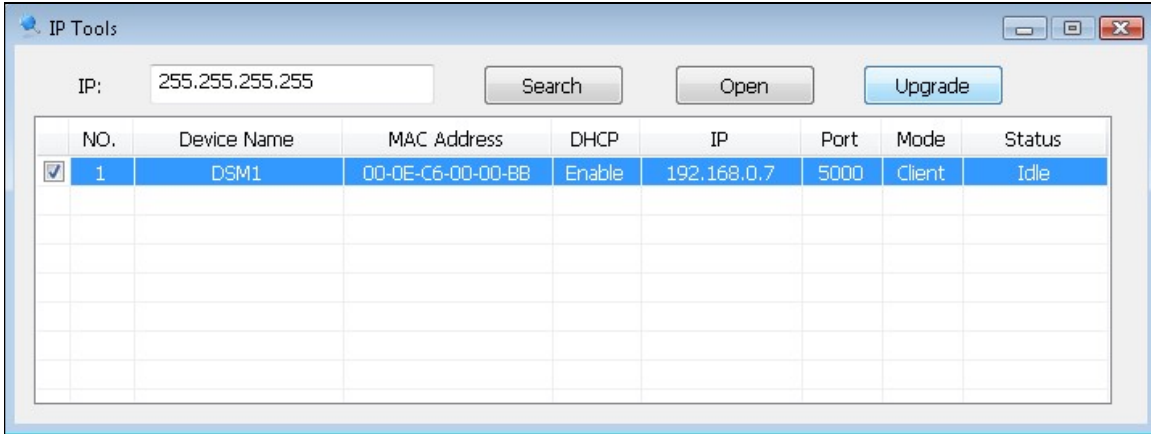
You must own a PC to update the firmware. Sorry, Linux and Apple products are currently not supported. Ambient Weather will update your ObserverIP at no cost (appropriate shipping charges will apply).

1. Download the latest version of firmware at:

<http://www.ambientweather.com/observerip.html>

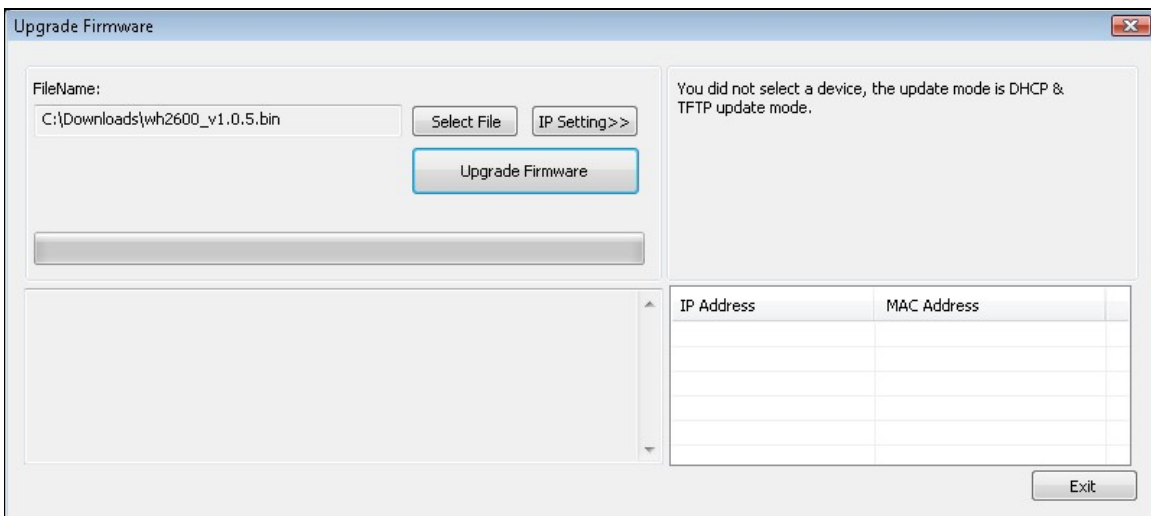
2. **Important Note: Close all of other applications while running the firmware update. This will insure the upgrade process will not be interrupted.**

3. Launch the IP Tools application as referenced in Section 3.7, and locate the ObserverIP on your network. Reference Figure 28. Select the Upgrade button to begin the firmware upgrade. As shown in this figure, the IP address of the ObserverIP is 192.168.0.7. Make a note of your IP address (your results will vary).



**Figure 28**

4. Reference Figure 29. Select the **Select File** button, and browse to the location of the file you downloaded in Step 1.

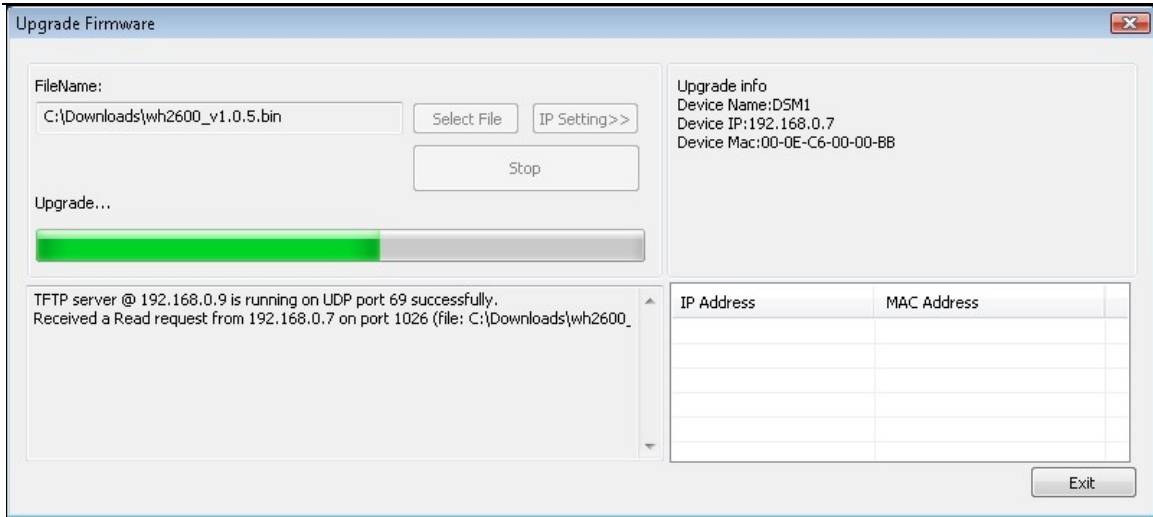


**Figure 29**

5. Select the Upgrade **Firmware** button. Reference Figure 30. The dialog box will display **Received a Read Request** from the ObserverIP module. A green progress bar will provide you with the upgrade status.

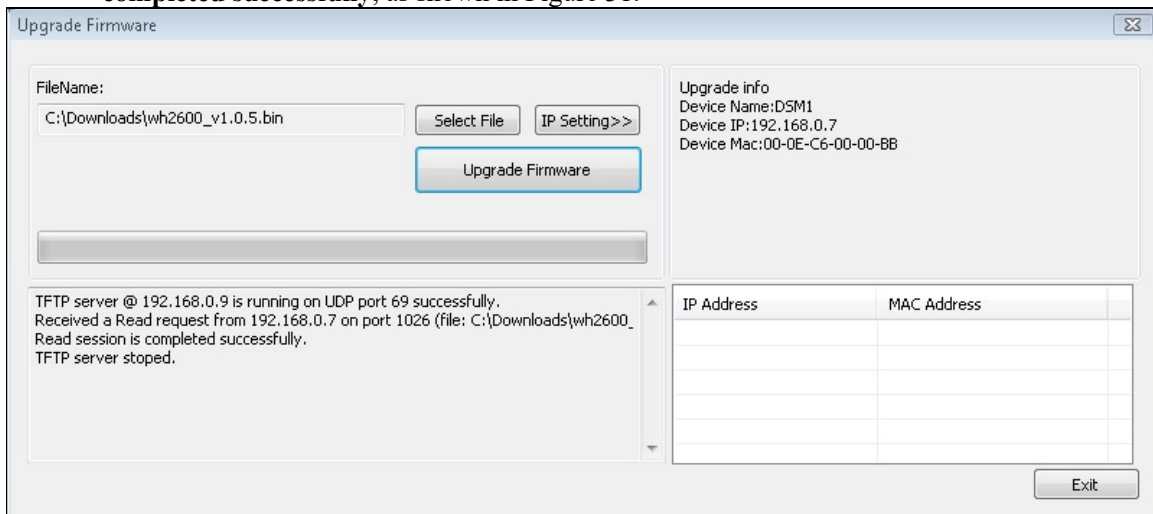
**DO NOT OPERATE THE MOUSE OR KEYBOARD WHEN UPGRADING** to prevent interruption of the upgrade.





**Figure 30**

- Once the firmware upgrade is complete, the dialog box will display **Read session is completed successfully**, as shown in Figure 31.



**Figure 31**

- Wait about one minute for the ObserverIP module to reboot. You can now **Exit** the upgrade window, and access the module again, as referenced in Section 3.7.

You may be required to enter some settings, so check all of the panels for completeness.

## 5. Glossary of Terms

Term	Definition
Absolute Barometric Pressure	Absolute pressure is the measured atmospheric pressure and is a function of altitude, and to a lesser extent, changes in weather conditions.  Absolute pressure is not corrected to sea-level conditions. <i>Refer to</i>

<b>Term</b>	<b>Definition</b>
	<i>Relative Barometric Pressure.</i>
Accuracy	Accuracy is defined as the ability of a measurement to match the actual value of the quantity being measured.
Barometer	A barometer is an instrument used to measure atmospheric pressure.
Calibration	Calibration is a comparison between measurements – one of known magnitude or correctness of one device (standard) and another measurement made in as similar a way as possible with a second device (instrument).
Dew Point	<p>The dew point is the temperature at which a given parcel of humid air must be cooled, at constant barometric pressure, for water vapor to condense into water. The condensed water is called dew. The dew point is a saturation temperature.</p> <p>The dew point is associated with relative humidity. A high relative humidity indicates that the dew point is closer to the current air temperature. Relative humidity of 100% indicates the dew point is equal to the current temperature and the air is maximally saturated with water. When the dew point remains constant and temperature increases, relative humidity will decrease.</p>
HectoPascals (hPa)	Pressure units in SI (international system) units of measurement. Same as millibars (1 hPa = 1 mbar)
Hygrometer	A hygrometer is a device that measures relative humidity. Relative humidity is a term used to describe the amount or percentage of water vapor that exists in air.
Inches of Mercury (inHg)	Pressure in Imperial units of measure. 1 inch of mercury = 33.86 millibars
Range	Range is defined as the amount or extent a value can be measured.
Relative Barometric Pressure	Measured barometric pressure relative to your location or ambient conditions.
Resolution	Resolution is defined as the number of significant digits (decimal places) to which a value is being reliably measured.
Thermometer	A thermometer is a device that measures temperature. Most digital thermometers are resistive thermal devices (RTD). RTDs predict change in temperature as a function of electrical resistance.

## 6. Specifications

### 6.1 Wireless Specifications

- Line of sight wireless transmission (in open air): 300 feet, 100 feet under most conditions
- Update Rate: about one minute
- Frequency: 915 MHz

## 6.2 Measurement Specifications

The following table provides the specifications for the measured parameters.

Measurement	Range	Accuracy	Resolution
Indoor Temperature	32 to 140 °F	± 2 °F	0.1 °F
Outdoor Temperature	-40 to 149 °F Lithium batteries -23 to 140 °F Alkaline batteries	± 2 °F	0.1 °F
Indoor Humidity	1 to 99%	± 5%	1 %
Outdoor Humidity	1 to 99%	± 5%	1 %
Barometric Pressure	8.85 to 32.50 inHg	± 0.08 inHg (within range of 27.13 to 32.50 inHg)	0.01 inHg

## 6.3 Power Consumption

- ObserverIP Receiver : 5V DC Adaptor (included)
- Indoor Thermo-hygrometer-barometer sensor : 2xAA batteries (not included)
- Outdoor Thermo-hygrometer sensor: 2xAA batteries (not included)

## 7. Troubleshooting Guide

If your question is not answered here, you can contact us as follows:

1. Email Support: [support@ambientweather.com](mailto:support@ambientweather.com)
2. Technical Support: 480-346-3398 (M-F 8am to 3pm Arizona Time)

Problem	Solution
Wireless remote(s) not reporting in to ObserverIP Receiver.	<p>The maximum line of sight communication range is about 300'. Move the sensor assembly closer to the ObserverIP receiver.</p> <p>Install a fresh set of batteries in the remote sensor(s).</p> <p>Do not lay the sensor(s) flat.</p> <p>Make sure the remote sensors are not transmitting through solid metal (acts as an RF shield), or earth barrier (down a hill). Radio Frequency (RF) Sensors cannot transmit through metal barriers (example, aluminum siding) or multiple, thick walls.</p> <p>Move the ObserverIP receiver around electrical noise generating devices, such as computers, TVs and other wireless transmitters or receivers.</p>
Temperature sensor reads too high in the day time.	<p>Make certain that the sensor is not too close to heat generating sources or structures, such as buildings, pavement, walls or air conditioning units.</p> <p>Make sure the thermo-hygrometer is mounted in a shaded area on the north facing wall.</p> <p>Use the calibration feature to offset installation issues related to radiant heat sources. Reference Section 3.8.5.</p>

Relative pressure does not agree with official reporting station	Make sure you properly calibrate the relative pressure to an official local weather station. Reference Section 3.8.5 for details.
Data not reporting to Wunderground.com®	<ol style="list-style-type: none"> <li>1. Confirm your password is correct. It is the password you registered on Wunderground.com®. Your Wunderground.com® password cannot begin with a non-alphanumeric character (a limitation of Wunderground.com, not the station). Example, \$oewkrf is not a valid password, but oewkrf\$ is valid.</li> <li>2. Confirm your station ID is correct. The station ID is all caps, and the most common issue is substituting an O for a 0 (or visa versa). Example, KAZPHOEN11, not KAZPH0EN11.</li> <li>3. Make sure your time zone is set properly. If incorrect, you may be reporting old data, not real time data.</li> <li>4. Check your router firewall settings. The ObserverIP sends data via Port 80.</li> </ol>
Only the Power, Link and ACT lights are lit and the ObserverIP module does not communicate to the server.	<p>The firmware will need to be reloaded.</p> <ol style="list-style-type: none"> <li>1. Download the latest firmware here: <a href="http://www.AmbientWeather.com/observerip.html">http://www.AmbientWeather.com/observerip.html</a></li> <li>2. Power down the ObserverIP module but leave connected to your router.</li> <li>3. Launch the IP Tools application as referenced in Section 3.7. Since the module is powered down, you will not be able to locate it on your network, but proceed anyway.</li> <li>4. Select the Upgrade button.</li> <li>5. Reference Figure 29. Select the <b>Select File</b> button, and browse to the location of the file you downloaded in Step 1.</li> <li>6. Select the Upgrade <b>Firmware button</b>.</li> <li>7. Plug in the ObserverIP module. The software will locate the device on your network and begin the update.  Reference Figure 30. The dialog box will display <b>Received a Read Request</b> from the ObserverIP module. A green progress bar will provide you with the upgrade status.  <b>DO NOT OPERATE THE MOUSE OR KEYBOARD WHEN UPGRADING</b> to prevent interruption of the upgrade.</li> <li>8. Once the firmware upgrade is complete, the dialog box will display <b>Read session is completed successfully</b>, as shown in Figure 31.</li> <li>9. Wait about one minute for the ObserverIP module to reboot. You</li> </ol>

	<p>can now <b>Exit</b> the upgrade window, and access the module again, as referenced in Section 3.7.</p> <p>All of the lights should be on except the Server light (you will need to reprogram the Wunderground.com settings).</p>
--	---

## 8. Liability Disclaimer

Please help in the preservation of the environment and return used batteries to an authorized depot. The electrical and electronic wastes contain hazardous substances. Disposal of electronic waste in wild country and/or in unauthorized grounds strongly damages the environment.

Reading the “User manual” is highly recommended. The manufacturer and supplier cannot accept any responsibility for any incorrect readings and any consequences that occur should an inaccurate reading take place.

This product is designed for use in the home only as indication of weather conditions. This product is not to be used for medical purposes or for public safety information.

The specifications of this product may change without prior notice.

This product is not a toy. Keep out of the reach of children.

No part of this manual may be reproduced without written authorization of the manufacturer.

Ambient, LLC WILL NOT ASSUME LIABILITY FOR INCIDENTAL, CONSEQUENTIAL, PUNITIVE, OR OTHER SIMILAR DAMAGES ASSOCIATED WITH THE OPERATION OR MALFUNCTION OF THIS PRODUCT.

## 9. FCC Statement

### **Statement according to FCC part 15.19:**

This device complies with part 15 of the FCC rules. Operation is subject to the following two conditions:

1. This device may not cause harmful interference.
2. This device must accept any interference received, including interference that may cause undesired operation.

### **Statement according to FCC part 15.21:**

Modifications not expressly approved by this company could void the user's authority to operate the equipment.

### **Statement according to FCC part 15.105:**

NOTE: This equipment has been tested and found to comply with the limits for a Class B digital device, pursuant to Part 15 of the FCC Rules. These limits are designed to provide reasonable protection against harmful interference in a residential installation. This equipment generates, uses and can radiate radio frequency energy and, if not installed and used in accordance with the instructions, may cause harmful interference to radio communications.

However, there is no guarantee that interference will not occur in a particular installation. If this equipment does cause harmful interference to radio or television reception, which can be determined by turning the equipment off and on, the user is encouraged to try to correct the interference by one or more of the following measures:

- Reorient or relocate the receiving antenna.

- Increase the separation between the equipment and receiver.
- Connect the equipment into an outlet on a circuit different from that to which the receiver is connected.
- Consult the dealer or an experienced radio/TV technician for help.

## 10. Warranty Information

Ambient, LLC provides a 1-year limited warranty on this product against manufacturing defects in materials and workmanship.

This limited warranty begins on the original date of purchase, is valid only on products purchased and only to the original purchaser of this product. To receive warranty service, the purchaser must contact Ambient, LLC for problem determination and service procedures.

Warranty service can only be performed by a Ambient, LLC. The original dated bill of sale must be presented upon request as proof of purchase to Ambient, LLC.

Your Ambient, LLC warranty covers all defects in material and workmanship with the following specified exceptions: (1) damage caused by accident, unreasonable use or neglect (lack of reasonable and necessary maintenance); (3) damage resulting from failure to follow instructions contained in your owner's manual; (4) damage resulting from the performance of repairs or alterations by someone other than an authorized Ambient, LLC authorized service center; (5) units used for other than personal use (6) applications and uses that this product was not intended (7) the products inability to receive a signal due to any source of interference or metal obstructions and (8) extreme acts of nature, such as lightning strikes or floods.

This warranty covers only actual defects within the product itself, and does not cover the cost of installation or removal from a fixed installation, normal set-up or adjustments, claims based on misrepresentation by the seller or performance variations resulting from installation-related circumstances.

