

For more detailed assembly and installation instructions, scan the QR code below to view our step-by-step installation video.



The package contains:

- All-In-One Outdoor Weather Sensor Array
- Display Console with Desk Stand
- Wind Vane
- Wind Cups
- Rain Gauge Funnel
- Rain Gauge Coil
- Mounting Hardware

What you will need:

- Precision Screwdriver
- Adjustable Wrench or 10mm Wrench

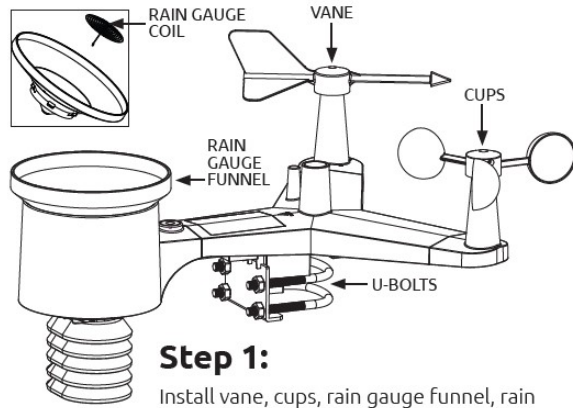

Step 1:

Install vane, cups, rain gauge funnel, rain gauge coil and U-bolts (not mounting).

Note: We recommend assembling the station indoors and moving it outside once the setup process is complete.

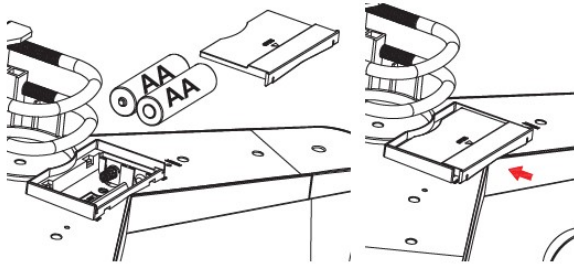

Step 2:

Insert the 2 - AA batteries into the bottom of the array and close the battery door completely.

Step 3:

Power up the console using the AC adapter. The console will also hold 3-AAA (not included) for backup battery power.

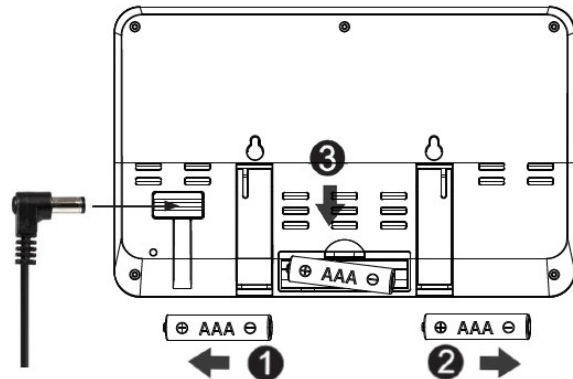

Step 4:

Install your array on a pole and tighten the U-bolts with a 10mm wrench. Please scan the QR code for mounting best practices.

Note: Supports poles 1.25-2" OD.

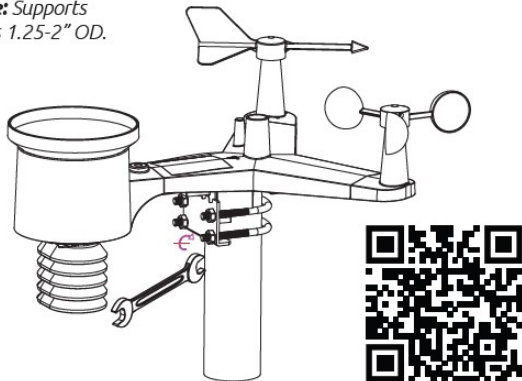

Ambient Weather WS-1900A OSPREY Solar Powered Wireless Weather Station User Manual



Table of Contents

1.	Introduction.....	3
2.	Warnings and Cautions	3
3.	Quick Start Guide	3
4.	Pre-Installation Checkout and Site Survey	4
4.1	Pre Installation Checkout	4
4.2	Site Survey	5
5.	Getting Started	6
5.1	Parts List	6
5.2	Recommend Tools.....	6
5.3	Sensor Array Set Up.....	7
5.3.1	Install Wind Vane	7
5.3.2	Install Wind Cups.....	8
5.3.3	Install U-Bolts.....	8
5.3.4	Install the Rain Gauge Funnel.....	9
5.3.5	Install the Funnel Coil Filter	9
5.3.6	Install Batteries	10
5.3.7	Install Mounting Pole.....	10
5.4	Best Practices for Wireless Communication	11
5.5	Display Console	11
5.5.1	Vertical Desk Stand.....	13
6.	Display Console Operation.....	14
6.1	Screen Display	14
6.2	Console Initialization	14
6.2.1	Button Operation.....	15
6.3	Set Mode	16
6.4	Barometric Pressure Display.....	18
6.4.1	Viewing Absolute vs. Relative Pressure.....	18
6.4.2	Rate of Change of Pressure Graph.....	18
6.4.3	Viewing Pressure History.....	19
6.4.4	Relative Pressure Calibration Discussion	19
6.5	Rain Display.....	19
6.5.1	Rain Increments of Measure	19
6.5.2	Resetting Rain.....	19
6.5.3	Increments of Rain Definitions	20
6.6	Wind Display	20
6.7	Temperature Display	20
6.7.1	Wind Chill, Dew Point and Heat Index Display	20
6.8	Alarms.....	20
6.8.1	Viewing High and Low Alarms	20
6.8.2	Setting High and Low Alarms.....	21
6.9	Max/Min Mode	24
6.9.1	Viewing Max/Min Values	24
6.10	Calibration.....	25
6.10.1	Calibration Settings	25
6.10.2	Calibration Ranges.....	26
6.10.3	Calibration Discussion.....	26
6.11	Restoring the Console to Factory Default.....	28
6.12	Resynchronize Wireless Sensor	28
6.13	Backlight Operation	28

6.13.1	With AC Adapter.....	28
6.13.2	Without AC Adapter	28
6.14	Tendency Arrows	28
6.15	Wireless Signal Strength Indicator.....	29
6.16	Weather Forecasting.....	29
6.16.1	Storm Alert.....	29
6.16.2	Weather Forecasting Description and Limitations.....	29
7.	Glossary of Terms.....	30
8.	Specifications.....	31
8.1	Wireless Specifications	31
8.2	Measurement Specifications	32
8.3	Power Consumption.....	32
9.	Maintenance.....	32
10.	Troubleshooting Guide.....	33
11.	Accessories.....	34
12.	Liability Disclaimer.....	34
13.	FCC Statement	34
14.	Warranty Information.....	35
15.	California Prop 65	35

1. Introduction

Thank you for your purchase of the Ambient Weather WS-1900A OSPREY Solar Powered Wireless Weather Station. The following user guide provides step by step instructions for installation, operation and troubleshooting. To download the latest manual and additional troubleshooting tips, please visit:

<https://help.ambientweather.net/product/ws-1900a>

2. Warnings and Cautions

 **Warning:** Any metal object may attract a lightning strike, including your weather station mounting pole. Never install the weather station in a storm.

 **Warning:** If you are mounting the weather station to a house or structure, consult a licensed electrician for proper grounding. A direct lightning strike to a metal pole can damage or destroy your home.

 **Warning:** Installing your weather station in a high location may result in injury or death. Perform as much of the initial check out and operation on the ground and inside a building or home. Only install the weather station on a clear, dry, day.

3. Quick Start Guide

Although the manual is comprehensive, much of the information contained may be intuitive. In addition, the manual does not flow properly because the sections are organized by components.

The following Quick Start Guide provides the necessary steps to install and operate the weather station, along with references to the pertinent sections.

Required		
Step	Description	Section
1	Assemble and power up the sensor array	5.3
2	Power up the display console and synchronize with sensor array	5.5
3	Mount the sensor array	5.3.7
4	Set date and time on console	6.3
5	Calibrate the relative pressure to sea-level conditions (local airport) on console	6.3
6	Reset the rain to zero on console	6.5.2

4. Pre-Installation Checkout and Site Survey

4.1 Pre Installation Checkout

Before installing your weather station in the permanent location, we recommend operating the weather station for one week in a temporary location with easy access. This will allow you to check out all of the functions, insure proper operation and familiarize you with the weather station and calibration procedures.

4.2 Site Survey - Mounting Guidelines

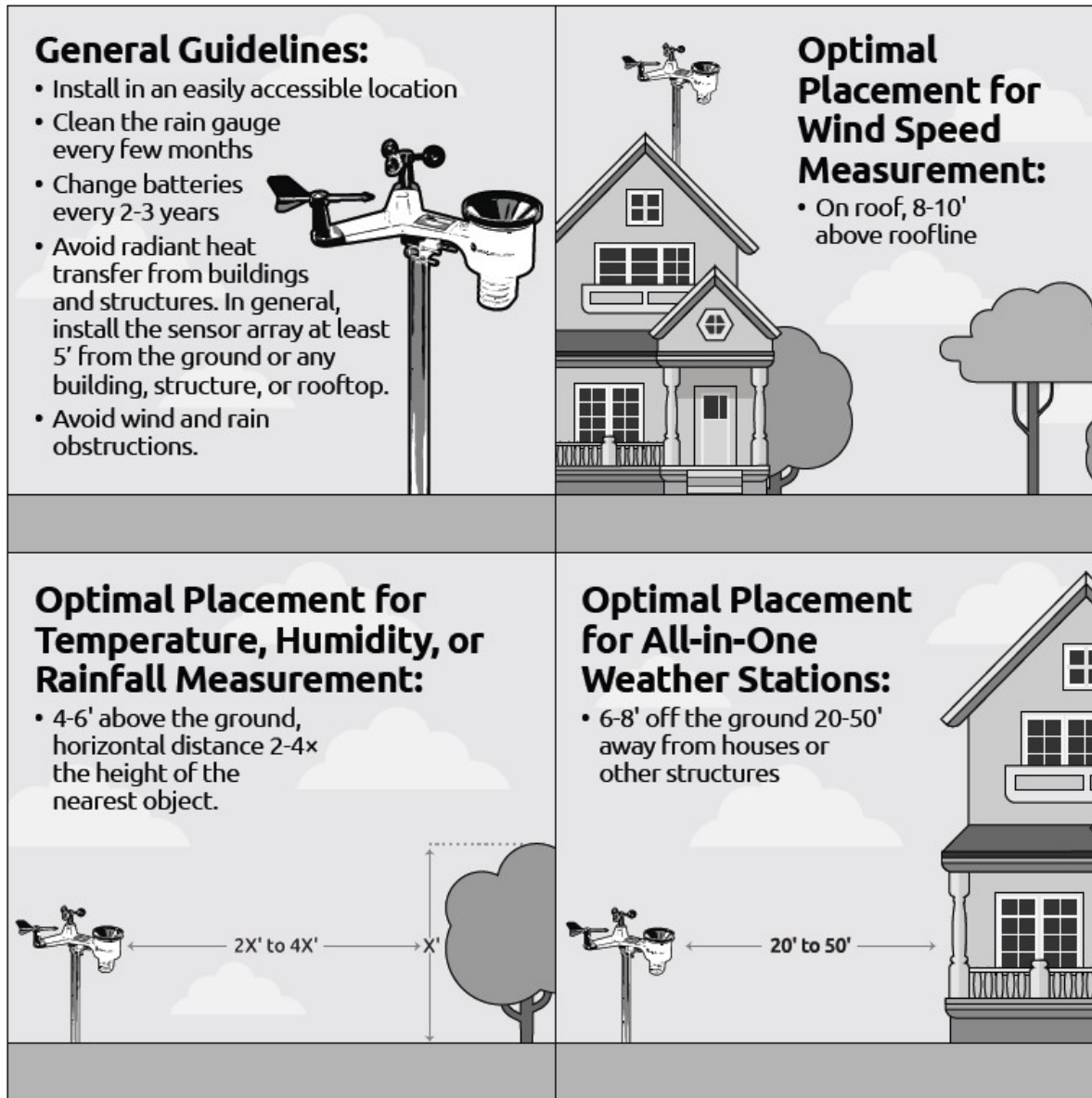

Perform a site survey before installing the weather station. Consider the following:

1. You must clean the rain gauge every few months and change the batteries every 2-3 years. Provide easy access to the weather station.
2. Avoid radiant heat transfer from buildings and structures. In general, install the sensor array at least 5' from any building, structure, ground, or rooftop.
3. Avoid wind and rain obstructions. The rule-of-thumb is to install the sensor array at least four times the difference in the height of the sensor array and that of the tallest obstruction. For example, if the building is 20' tall and the mounting pole is 6' tall, install the sensor array $4 \times (20 - 6) = 56'$ away.
4. Mount the sensor array in direct sunlight for accurate temperature readings.
5. Installing the weather station over sprinkler systems or other unnatural vegetation may affect temperature and humidity readings. We suggest mounting the sensor array over natural vegetation.
6. Wireless Range. Radio communication between receiver and transmitter in an open field can reach a distance of up to 330 feet, providing there are no interfering obstacles such as buildings, trees, vehicles and high voltage lines. Wireless signals will not penetrate metal buildings. Under most conditions, the maximum wireless range is 100'.
7. Radio Interference. Computers, radios, televisions, and other sources can interfere with radio

communications between the sensor array and console. Please take this into consideration when choosing console or mounting locations. Make sure your display console is at least five feet away from any electronic device to avoid interference.

8. Visit Ambient Weather Mounting Solutions for assistance and ideas for mounting your weather station:

<http://www.ambientweather.com/amwemoso.html>

5. Getting Started

The Ambient Weather WS-1900A OSPREY Personal Weather Station consists of an indoor display console and an all-in-one outdoor weather sensor array.

5.1 Parts List

QTY	Item
1	Display Console Frame Dimensions (LxWxH): 7.50 x 4.50 x 0.75" LCD Dimensions (LxW): 3.00 x 6.75"
1	Vertical Desk Stand
1	Sensor Array
1	Wind Vane
1	5V DC Adaptor
2	Pole mounting U-bolts
2	Pole mounting U-bolt nuts
1	User manual

5.2 Recommend Tools

- Precision screwdriver (for small Phillips screw on wind vane and wind cups)
- Adjustable wrench (for mounting pole)
- Compass or GPS (for wind direction calibration)

5.3 Sensor Array Set Up

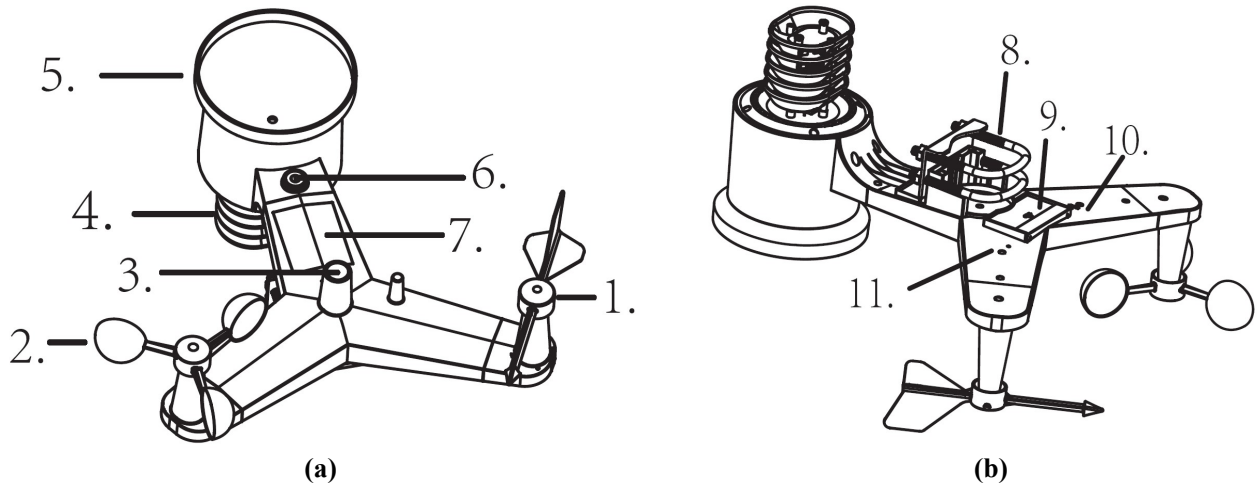



Figure 1

No	Description	No	Description
1	Wind Vane (measures wind direction)	7	Solar panel
2	Wind Speed Sensor (measures wind speed)	8	U-Bolt
3	UV sensor/ Light sensor	9	Battery compartment
4	Thermometer-hygrometer sensor (measures temperature and humidity)	10	Reset button
5	Rain collector	11	LED transmitter Indicator
6	Bubble level		

5.3.1 Install Wind Vane

Reference Figure 2. (a) Locate and align the flat key on the wind vane shaft to the flat key on the wind vane and push the vane on to the shaft. (b) tighten the set screw with a precision screw driver and make sure the wind vane spins freely.

 **Note:** You may need to back out the set screw first before sliding the vane onto the shaft.

 **Note:** The wind vane shaft does not spin as freely as the wind cups. This is by design. The dampening prevents the wind vane from spinning with the slightest breeze, which will result in variable wind all of the time. The added resistance allows the wind vane to change direction with 2 – 3 mph, providing a much better wind direction tracking.

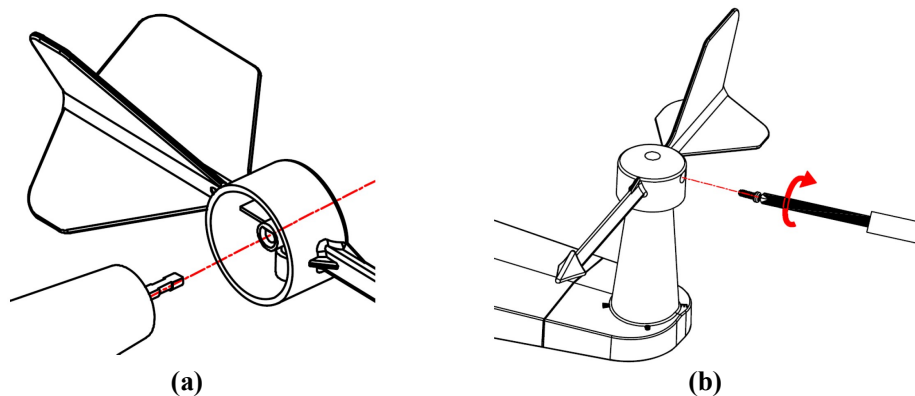



Figure 2

5.3.2 Install Wind Cups

Reference Figure 3. (a) push the wind cups on to the shaft. (b) tighten the set screw with a precision screw driver and make sure the wind cups spin freely.

 **Note:** You may need to back out the set screw first before sliding the cups onto the shaft.

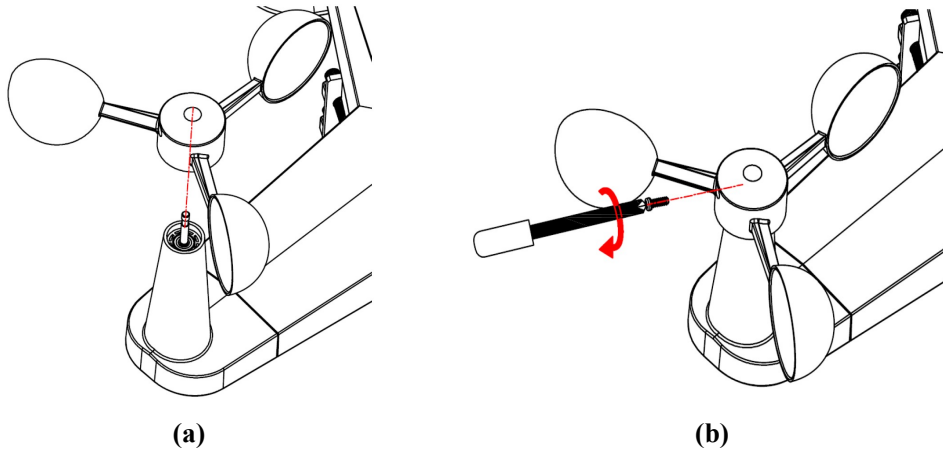
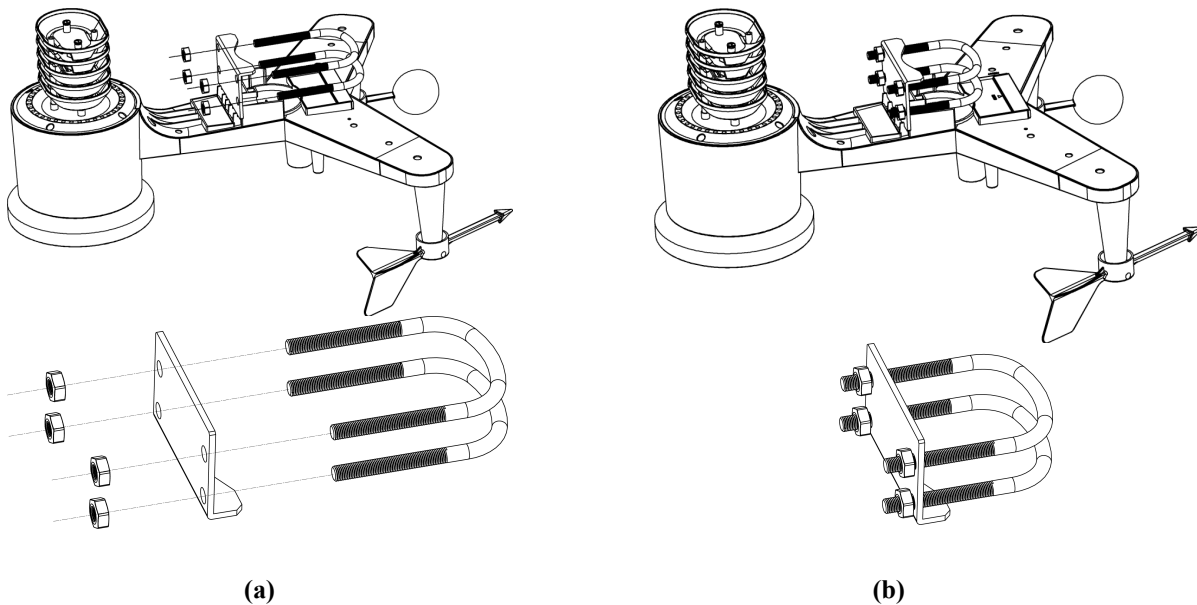

Figure 3

5.3.3 Install U-Bolts

Note: Your U-bolts may have come preassembled at the factory.

- (a) Insert the U-Bolts into the sensor array mounting bracket and hand tighten the nuts.
- (b) Tighten the nuts to fit the size of your mounting pole (between 1" and 2" diameter)
- (c) Insert the sensor array and U-Bolt assembly onto the mounting pole.
- (d) Tighten the U-Bolts around the pole with an adjustable wrench. Make sure the sensor array is level.



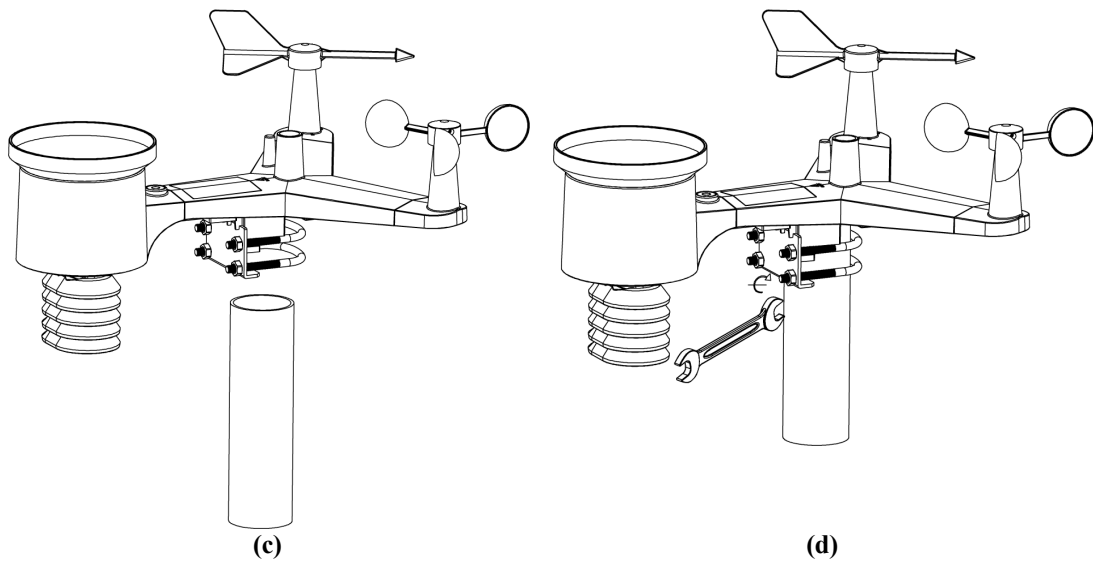

Figure 4

5.3.4 Install the Rain Gauge Funnel

Reference Figure 5. Install the rain gauge funnel. Rotate clockwise to attach the funnel to the sensor array.

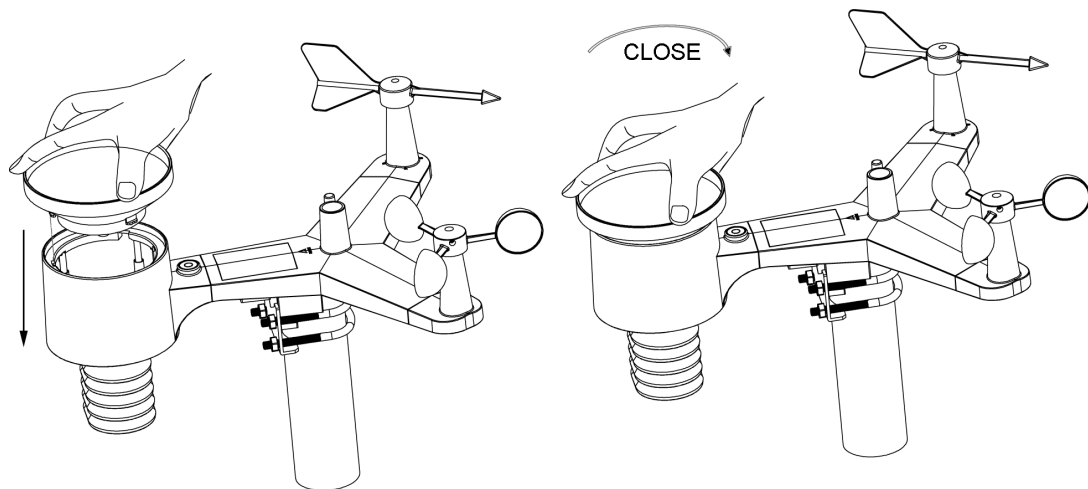
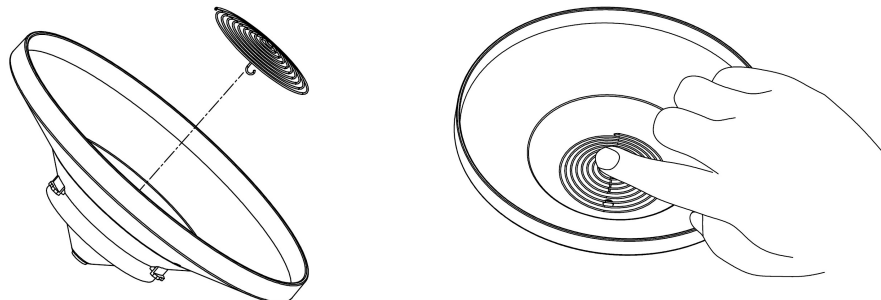

Figure 5

5.3.5 Install the Funnel Coil Filter

To install the funnel coil filter, press the coil until the hook is inside the hole at the bottom of the funnel, and locked in place. The spring tension will keep the filter sit tight on the funnel.



5.3.6 Install Batteries

Reference Figure 6. Insert 2 x AA non-rechargeable batteries (not included) into the battery compartment. The LED indicator on the back of the transmitter will turn on for four seconds, and then flash once every 16 seconds (the sensor transmission update period).

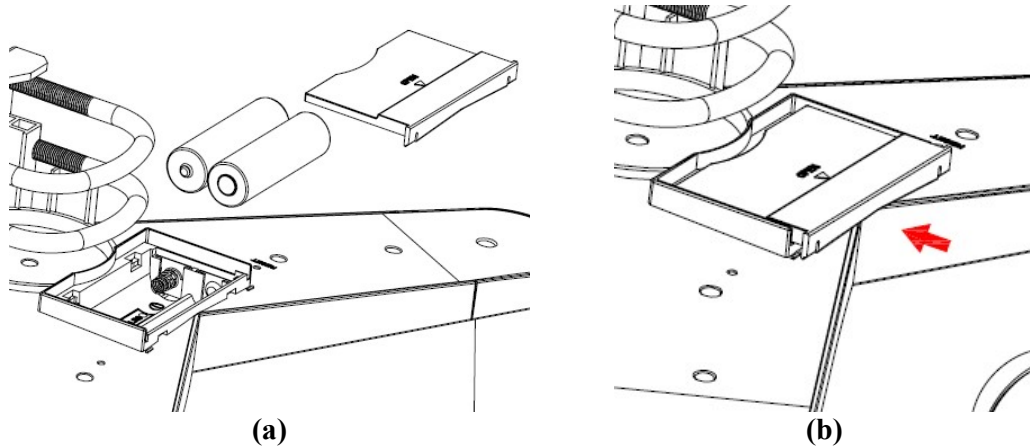



Figure 6

 **Note:** If the LED does not light up, or stays on permanently, make sure the battery polarity is correct, or the batteries are fresh. Do not install the batteries backwards. You can permanently damage the thermo-hygrometer.

 **Note:** We recommend lithium batteries for cold weather climates, but alkaline batteries are sufficient for most climates. We do not recommend rechargeable batteries. They have lower voltages, do not operate well at wide temperature ranges, and do not last as long, resulting in poorer reception.

5.3.7 Install Mounting Pole

Reference Figure 7. The mounting assembly includes two U-Bolts and a bracket that tightens around a 1 to 2" diameter pole (not included) using the four U-Bolt nuts.

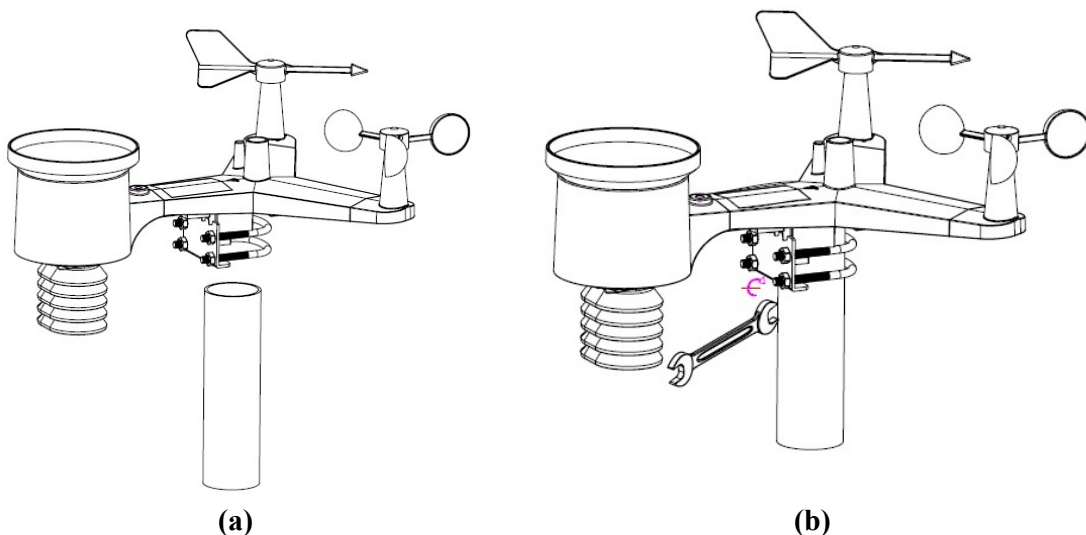



Figure 7

Use the bubble level next to the rain sensor to make sure the sensor array is completely level. If the sensor array is not level, the rain gauge, UV and solar radiation sensors will not measure properly.

 **Note:** If you cannot read the bubble level due to mounting constraints, place straddle a line or ruler level across the top of the rain gauge for easier viewing.

5.3.7.1 Aligning the Wind Direction

Locate the four wind vane compass rose indicators of N, E, S, W (representing North, East, South and West) at the base of the wind vane. Align the compass rose direction upon final installation with a compass or GPS.

5.4 Best Practices for Wireless Communication

Wireless communication is susceptible to interference, distance, walls and metal barriers. We recommend the following best practices for trouble free wireless communication.

1. **Electro-Magnetic Interference (EMI).** Keep the console several feet away from computer monitors and TVs.
2. **Radio Frequency Interference (RFI).** If you have other 915 MHz devices and communication is intermittent, try turning off these other devices for troubleshooting purposes. You may need to relocate the transmitters or receivers to avoid intermittent communication.
3. **Line of Sight Rating.** This device is rated at 300 feet line of sight (no interference, barriers or walls) but typically you will get 100 feet maximum under most real-world installations, which include passing through barriers or walls.
4. **Metal Barriers.** Radio frequency will not pass through metal barriers such as aluminum siding. If you have metal siding, align the remote and console through a window to get a clear line of sight.

The following is a table of reception loss vs. the transmission medium. Each “wall” or obstruction decreases the transmission range by the factor shown below.

Medium	RF Signal Strength Reduction
Glass (untreated)	5-15%
Plastics	10-15%
Wood	10-40%
Brick	10-40%
Concrete	40-80%
Metal	90-100%

5.5 Display Console

The front and back of the display console is shown in Figure 8 and Figure 9.

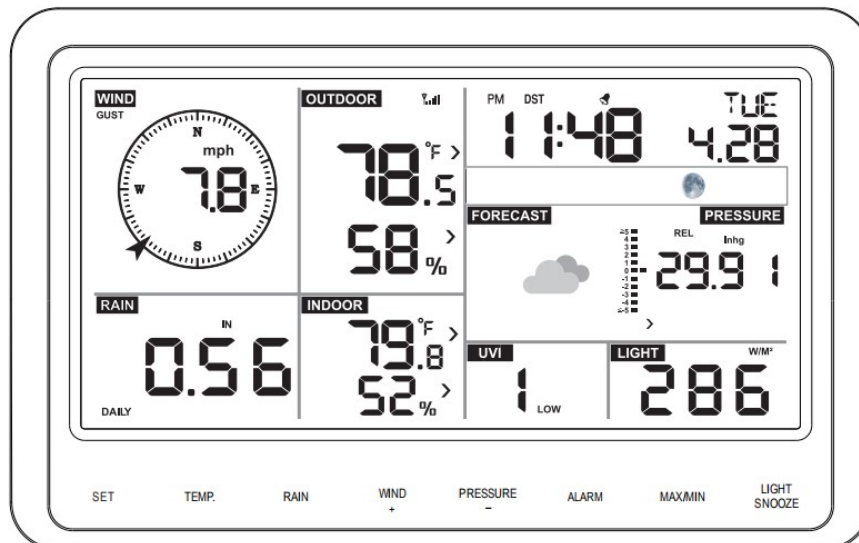

Figure 8

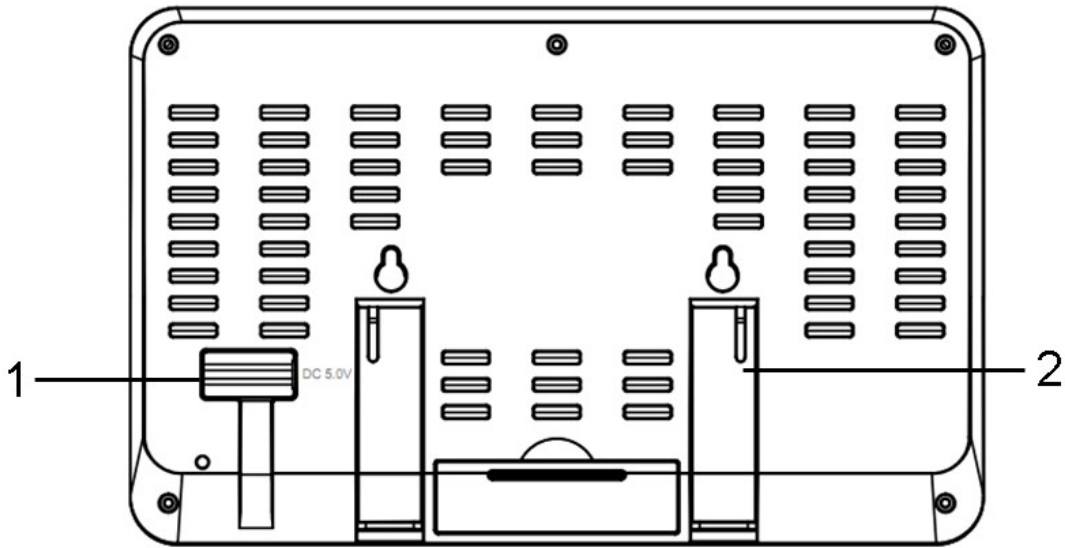

Figure 9

Reference Figure 9.

- (1) Connect the display console power jack to AC power adapter with the included power adapter.
 - (2) Unfold the desk stand and place 5 to 10 feet away from the sensor array.
- Remove the battery door on the back of the console, and insert 3xAAA batteries per Figure 10.
- (3) Wait several minutes for the remote sensors to synchronize with the display console.

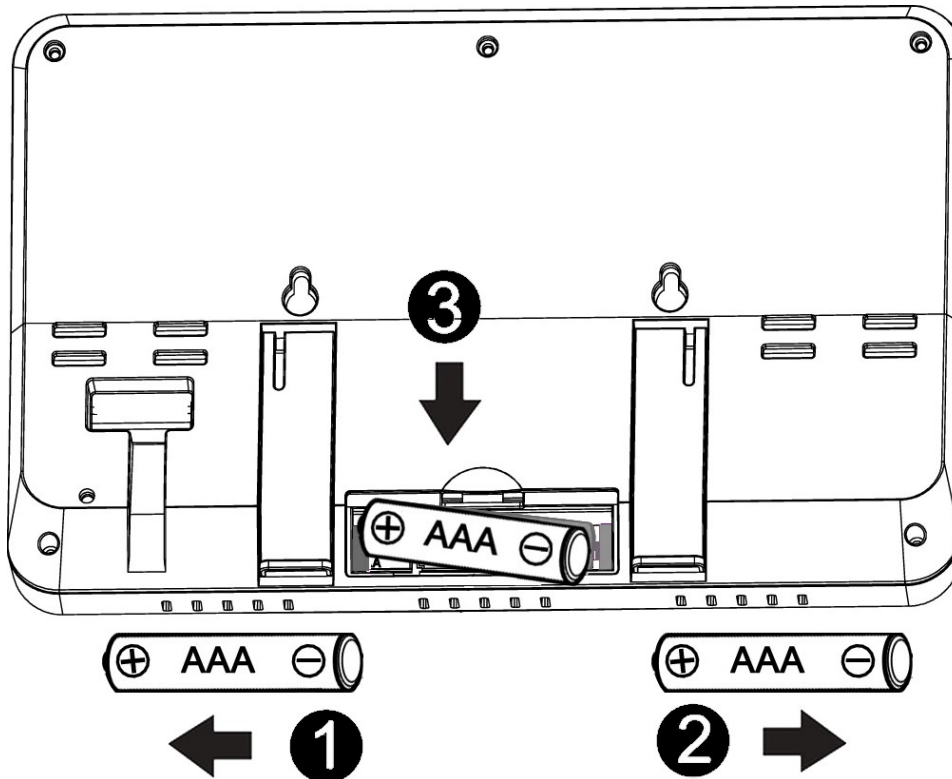

Figure 10

5.5.1 Vertical Desk Stand

The console is best viewed above from a 20 to 30 degree angle.

In addition to the fold out desk stand on the back of the display, console, the console also includes a vertical desk stand to improve the viewing angle on a desk, as shown in Figure 11.

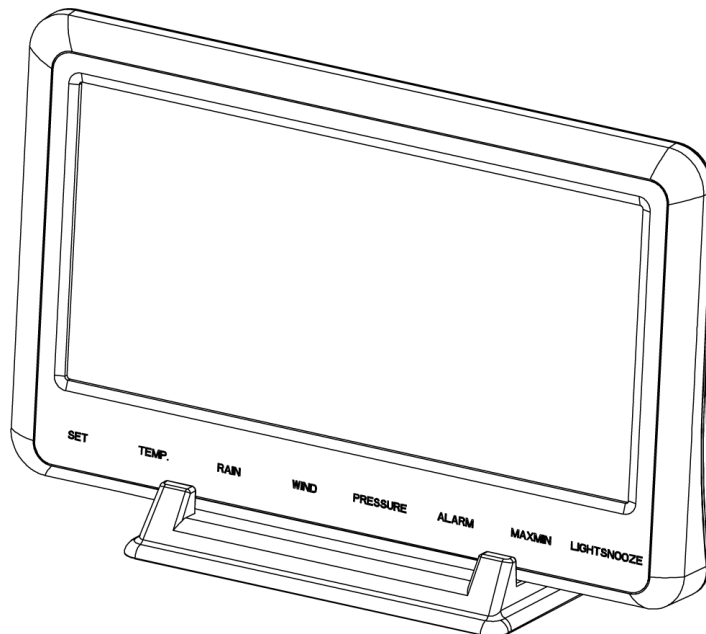

Figure 11

6. Display Console Operation

6.1 Screen Display

The display console home screen layout is shown in Figure 12.

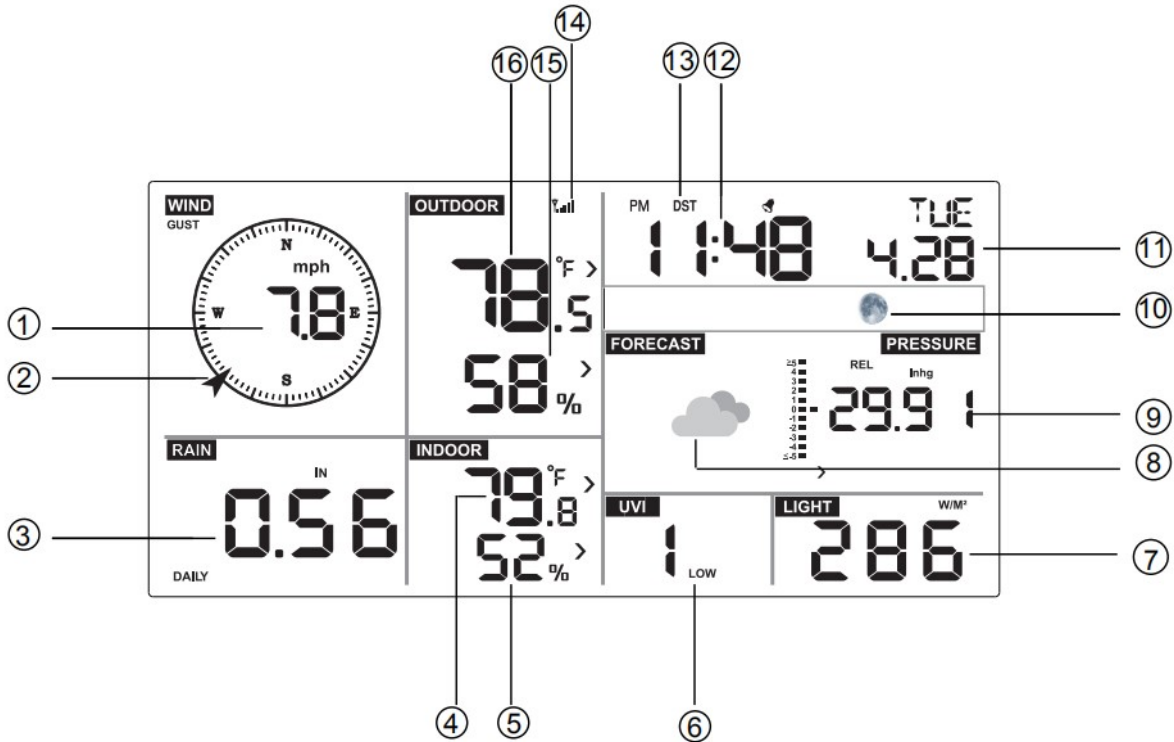

Figure 12

No	Description	No	Description
1	Wind speed	9	Barometric Pressure
2	Wind direction	10	Moon phase
3	Rainfall	11	Date
4	Indoor temperature	12	Time
5	Indoor humidity	13	DST
6	UV index	14	RF icon
7	Solar Radiation	15	Outdoor humidity
8	Weather forecast	16	Outdoor temperature

6.2 Console Initialization

After the console is connected to AC power, the console will display the software version number two seconds after power up.



Figure 13

The console will display all of the LCD segments for three seconds after power up as shown in Figure 14, the indoor

conditions will immediately update, and the outdoor sensor array will register within a few minutes.

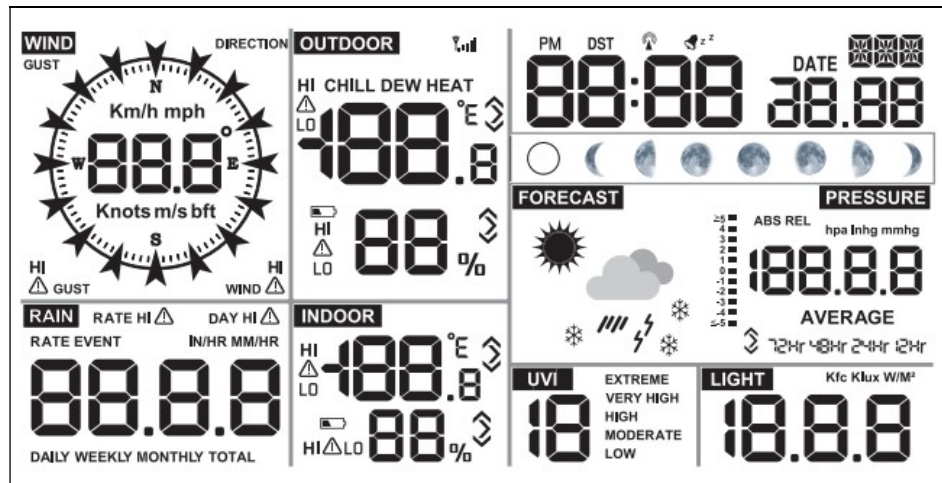

Figure 14

6.2.1 Button Operation

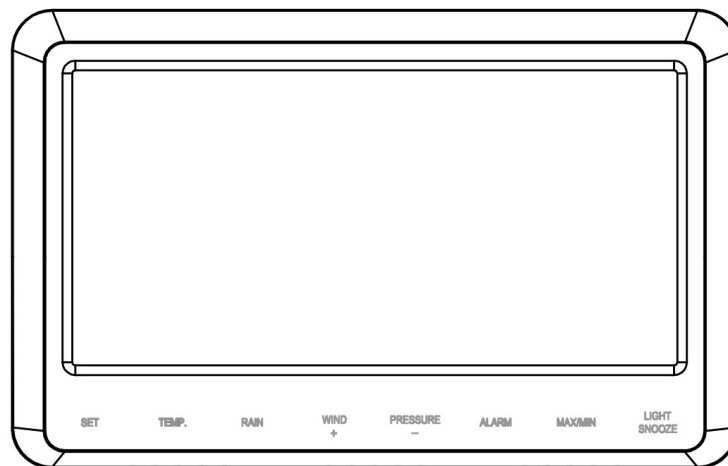

Figure 15

The console has 8 buttons at the bottom for easy operation:

Key	Description
SET	Press and hold to enter the SET mode.
TEMP	<ul style="list-style-type: none"> Press to switch between Outdoor Temperature, Wind Chill, Heat Index, Dew Point. To bypass RF reception, press and hold while powering up the console (connecting the AC adapter with batteries removed).
RAIN	Press to switch between Rain Rate (in/hr), Rain Event, Rain Day, Rain Week, Rain Month, and Rain Total.
WIND +	<ul style="list-style-type: none"> Press to switch between average wind speed, wind gust and wind direction. While in SET mode, press to increase the value. Press and hold for two seconds to increase the value rapidly.
PRESSURE -	<ul style="list-style-type: none"> Press to switch between Relative Pressure (current), and 12hr, 24hr, 48hr and 72hr average Relative Pressure. While in SET mode, press to decrease the value. Press and hold for two seconds to







	decrease the value rapidly.
ALARM	Press to switch between high and low alarms
MAX/MIN	Press to switch between minimum and maximum values.
LIGHT/SNOOZE	<ul style="list-style-type: none"> • Press to adjust the LCD backlight brightness (high, medium and off). • Press to exit the SET mode at any time.





6.3 Set Mode

Press and hold the **SET** button for two seconds to enter the SET Mode. To proceed to the next setting, press (do not hold) the **SET** button.

To exit the SET mode at any time, press the **LIGHT / SNOOZE** button.

Figure 16 summarizes the set mode sequence and commands.

Command	Mode	Settings	Image
[SET] + 2 seconds	Enter Set Mode, Beep On or Off	Press [WIND +] to switch OFF and ON. This will prevent the beep from sounding when pressing any button.	
[SET]	Clear Max/Min	Press [WIND +] to switch OFF and ON. When set to ON, the minimum and maximum values reset every day at midnight (00:00). When set to OFF, the minimum and maximum values must be reset manually.	
[SET]	Daylight Savings Time (DST)	Press [WIND +] to switch DST OFF and ON. Set to ON (most locations) if you observe daylight savings time, and the clock will automatically adjust twice per year. Set to OFF (Arizona and Hawaii) if you do not observe DST.	
[SET]	Time Zone	Not used with this model.	
[SET]	12 hour / 24 Hour Format	Press [WIND +] to switch hour format between 12 hour and 24 hour format.	
[SET]	Hour	Press [WIND +] or [PRESSURE -] to adjust hour up or down.	
[SET]	Minute	Press [WIND +] or [PRESSURE -] to adjust minute up or down.	
[SET]	Date Format	Press [WIND +] to switch between MM-DD (month-day) and DD-MM (day-month)	
[SET]	Year	Press [WIND +] or [PRESSURE -] to adjust year up or down	
[SET]	Month	Press [WIND +] or [PRESSURE -] to adjust month up or down	
[SET]	Day	Press [WIND +] or [PRESSURE -] to adjust day up or down	
[SET]	Pressure Units of Measure	Press [WIND +] to change units of measure between hpa, mmHg or inHg.	
[SET]	Relative Pressure Calibration	Press [WIND +] or [PRESSURE -] to adjust relative pressure up or down Reference Section 6.4.4 for details on calibration of relative pressure.	
[SET]	Light Units of Measure	Press [WIND +] to change light units of measure between lux, fc, or w/m2	

[SET]	Temperature Units of Measure	Press [WIND +] to change temperature units of measure between °F and °C.	
[SET]	Wind Units of Measure	Press [WIND +] to change wind units of measure between km/h, mph, knots, m/s and bft.	
[SET]	Rain Units of Measure	Press [WIND +] to change rain units of measure between in and mm.	
[SET]	Hemisphere	Press [WIND +] to change hemisphere between NTH (northern) and STH (southern). This setting effects the moon phase display.	
[SET]	Exit Set Mode		

[SET] + 2 seconds means press and hold the SET button for two seconds.

[SET] means press the SET button.

Figure 16

6.4 Barometric Pressure Display

6.4.1 Viewing Absolute vs. Relative Pressure

To switch between absolute and relative pressure, press and hold the [PRESSURE -] button for two seconds.

Absolute pressure is the measured atmospheric pressure, and is a function of altitude, and to a lesser extent, changes in weather conditions.

Absolute pressure is not corrected to sea-level conditions.

Relative pressure is corrected to sea-level conditions. For further discussion of relative pressure and calibration, reference Section 6.4.4.

6.4.2 Rate of Change of Pressure Graph

The rate of change of pressure graphic is shown to the left of the barometric pressure and signifies the difference between the daily average pressure and the 30 day average (in hPa).



Figure 17

6.4.3 Viewing Pressure History

Press the [PRESSURE -] button to view the 12 hour, 24 hour, 48 hour and 72 hour pressure average.

6.4.4 Relative Pressure Calibration Discussion

To compare pressure conditions from one location to another, meteorologists correct pressure to sea-level conditions. Because the air pressure decreases as you rise in altitude, the sea-level corrected pressure (the pressure your location would be at if located at sea-level) is generally higher than your measured pressure.

Thus, your absolute pressure may read 28.62 inHg (969 mb) at an altitude of 1000 feet (305 m), but the relative pressure is 30.00 inHg (1016 mb).

The standard sea-level pressure is 29.92 inHg (1013 mb). This is the average sea-level pressure around the world. Relative pressure measurements greater than 29.92 inHg (1013 mb) are considered high pressure and relative pressure measurements less than 29.92 inHg are considered low pressure.

To determine the relative pressure for your location, locate an official reporting station near you (the internet is the best source for real time barometer conditions, such as Weather.com or Wunderground.com), and set your weather station to match the official reporting station.

6.5 Rain Display

6.5.1 Rain Increments of Measure

Press the RAIN button to switch between Rain Rate (in/hr), Rain Event, Rain Day, Rain Week, Rain Month, and Rain Total.

6.5.2 Resetting Rain

Display the increment of rain you wish to clear, as shown in Section 6.5.1.

To reset the rain totals, press and hold the RAIN button for two seconds.

- Resetting the weekly rain also resets the daily rain.
- Resetting the monthly rain also resets the daily and weekly rain.
- Resetting the total rain also resets the monthly, weekly and daily rain.

6.5.3 Increments of Rain Definitions

- **Rain rate or hourly rain** is defined as the last 10 minutes of rainfall, multiplied by six (10 minutes x 6 = 1 hour). This is also referred to as instantaneous rain per hour.
- **Rain event** is defined as continuous rain, and resets to zero if rainfall accumulation is less than 10 mm (0.039 in) in a 24 hour period.
- **Daily Rain** is defined as the rainfall since midnight (00:00).
- **Weekly Rain** is defined as the calendar week total and resets on Sunday morning at midnight (Sunday thru Saturday).
- **Monthly Rain** is defined as the calendar month total and resets on the first day of the Month.
- **Total Rain** is defined as the running total since station was powered up.

6.6 Wind Display

Press the [WIND +] button to switch between average wind speed, wind gust and wind direction.

- Wind speed is defined as the average wind speed in the 16 second update period.
- Wind gust is defined as the peak wind speed in the 16 second update period.

6.7 Temperature Display

If temperature is lower than minimum range, the temperature field will display dashes (--.).

If temperature is higher than maximum range, the temperature field will display dashes (--.).

6.7.1 Wind Chill, Dew Point and Heat Index Display

Press the [TEMP] button to switch between Outdoor Temperature, Wind Chill, Heat Index, Dew Point.

6.8 Alarms

6.8.1 Viewing High and Low Alarms

To view the high alarm settings, press (do not hold) the **ALARM** button, and the high alarms will be displayed, as shown in Figure 18 (a).

To view the low alarm settings, press the **ALARM** button again, and the low alarms will be displayed, as shown in Figure 18 (b).

To return to normal mode, press the **ALARM** button again.

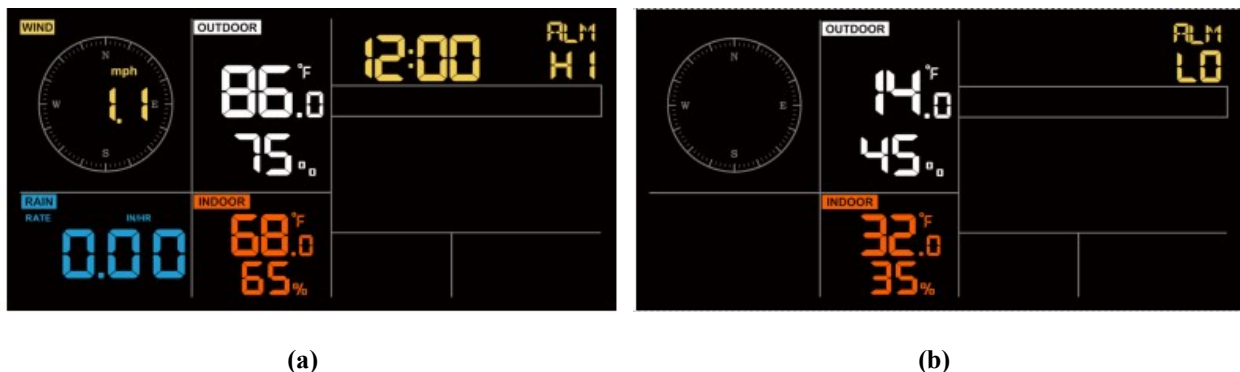

Figure 18

6.8.1.1 Rain Alarm

While the High Alarm is displayed (reference Section 6.8.1), press the **RAIN** button to display the rain rate and daily rain alarm values.

6.8.1.2 Wind Alarm







While the High Alarm is displayed (reference Section 6.8.1), press the **WIND** button to display the wind speed and wind gust alarm values.







6.8.2 Setting High and Low Alarms

Press and hold the **ALARM** button for two seconds to enter the ALARM Set Mode. To save and proceed to the next alarm setting, press (do not hold) the **SET** button.

To exit the alarm mode at any time, press the **LIGHT / SNOOZE** button.

Figure 19 summarizes the alarm mode sequence and commands.

Command	Mode	Settings
[ALARM] + 2 seconds	Enter Alarm Set Mode, Alarm Hour	Press [WIND +] or [PRESSURE -] to adjust alarm hour up or down. Press [ALARM] to turn the time alarm on or off. When the alarm is on, the alarm time icon  will appear.
[SET]	Alarm Minute	Press [WIND +] or [PRESSURE -] to adjust alarm minute up or down. Press [ALARM] to turn the time alarm on. The alarm time icon  will appear. Press [ALARM] again to turn the time alarm off. The alarm time icon will disappear.
[SET]	Alarm High Indoor Temperature	Press [WIND +] or [PRESSURE -] to adjust alarm value up or down. Press [ALARM] to turn the alarm on. The alarm icon  will appear. Press [ALARM] to turn the alarm off. The alarm icon will disappear.
[SET]	Alarm Low Indoor Temperature	Press [WIND +] or [PRESSURE -] to adjust alarm value up or down. Press [ALARM] to turn the alarm on. The alarm icon  will appear. Press [ALARM] to turn the alarm off. The alarm icon will disappear.
[SET]	Alarm High Indoor Humidity	Press [WIND +] or [PRESSURE -] to adjust alarm value up or down. Press [ALARM] to turn the alarm on. The alarm icon  will appear. Press [ALARM] to turn the alarm off. The alarm icon will disappear.
[SET]	Alarm Low Indoor Humidity	Press [WIND +] or [PRESSURE -] to adjust alarm value up or down. Press [ALARM] to turn the alarm on. The alarm icon  will appear. Press [ALARM] to turn the alarm off. The alarm icon will disappear.
[SET]	Alarm High Outdoor Temperature	Press [WIND +] or [PRESSURE -] to adjust alarm value up or down. Press [ALARM] to turn the alarm on. The alarm icon  will appear. Press [ALARM] to turn the alarm off. The alarm icon will disappear.

[SET]	Alarm Low Outdoor Temperature	<p>Press [WIND +] or [PRESSURE -] to adjust alarm value up or down.</p> <p>Press [ALARM] to turn the alarm on. The alarm icon  will appear.</p> <p>Press [ALARM] to turn the alarm off. The alarm icon will disappear.</p>
[SET]	Alarm High Outdoor Humidity	<p>Press [WIND +] or [PRESSURE -] to adjust alarm value up or down.</p> <p>Press [ALARM] to turn the alarm on. The alarm icon  will appear.</p> <p>Press [ALARM] to turn the alarm off. The alarm icon will disappear.</p>
[SET]	Alarm Low Outdoor Humidity	<p>Press [WIND +] or [PRESSURE -] to adjust alarm value up or down.</p> <p>Press [ALARM] to turn the alarm on. The alarm icon  will appear.</p> <p>Press [ALARM] to turn the alarm off. The alarm icon will disappear.</p>
[SET]	Alarm High Wind Speed	<p>Press [WIND +] or [PRESSURE -] to adjust alarm value up or down.</p> <p>Press [ALARM] to turn the alarm on. The alarm icon  will appear.</p> <p>Press [ALARM] to turn the alarm off. The alarm icon will disappear.</p>
[SET]	Alarm High Wind Gust	<p>Press [WIND +] or [PRESSURE -] to adjust alarm value up or down.</p> <p>Press [ALARM] to turn the alarm on. The alarm icon  will appear.</p> <p>Press [ALARM] to turn the alarm off. The alarm icon will disappear.</p>
[SET]	Alarm High Rain Rate	<p>Press [WIND +] or [PRESSURE -] to adjust alarm value up or down.</p> <p>Press [ALARM] to turn the alarm on. The alarm icon  will appear.</p> <p>Press [ALARM] to turn the alarm off. The alarm icon will disappear.</p>

[SET]	Alarm High Daily Rain	<p>Press [WIND +] or [PRESSURE -] to adjust alarm value up or down.</p> <p>Press [ALARM] to turn the alarm on. The alarm icon  will appear.</p> <p>Press [ALARM] to turn the alarm off. The alarm icon will disappear.</p>
[SET]	Exit alarm settings mode.	

[ALARM] + 2 seconds means press and hold the ALARM button for two seconds.

[ALARM] means press the ALARM button.

Figure 19

6.9 Max/Min Mode

6.9.1 Viewing Max/Min Values

To view the max value, press (do not hold) the **MAX/MIN** button, and the max values will be displayed, as shown in Figure 20 (a). To clear the max values, press and hold the MAX/MIN button while the max values are displayed.

To view the low alarm settings, press the **MAX/MIN** button again, and the min values will be displayed, as shown in Figure 20 (b). To clear the min values, press and hold the MAX/MIN button while the min values are displayed.

To return to normal mode, press the **MAX/MIN** button again.



(a)

(b)

Figure 20

6.9.1.1 Display Wind Chill, Heat Index vs. Dew Point Max/Min Values

While the **max values** are displayed as outlined in Section 6.9.1, press the **TEMP** button once to view the heat index, twice to view the dew point, and a third time to return to outdoor temperature.

While the **min values** are displayed as outlined in Section 6.9.1, press the **TEMP** button once to view the wind chill, twice to view the dew point, and a third time to return to outdoor temperature.

6.9.1.2 Display Wind Speed vs. Wind Gust Max Values

While the **max values** are displayed as outlined in Section 6.9.1, press the **WIND +** button once to view the max wind gust, and twice to return to wind speed.

6.9.1.3 Display Rain Rate, Daily Rain, Weekly Rain and Monthly Rain Max Values

While the **max values** are displayed as outlined in Section 6.9.1, press the **RAIN** button once to view the max daily rain, twice to view the max weekly rain, three times to view the max monthly rain, four times to return to the max rain rate.

6.9.1.4 Display Absolute and Relative Pressure Min and Max Values

While the **max values** are displayed as outlined in Section 6.9.1, press and hold the **PRESSURE** button for two seconds to view the absolute pressure, and press and hold the **PRESSURE** button for two seconds again to return to relative pressure.

While the **min values** are displayed as outlined in Section 6.9.1, press and hold the **PRESSURE** button for two seconds to view the absolute pressure, and press and hold the **PRESSURE** button for two seconds again to return to relative pressure.

6.10 Calibration

6.10.1 Calibration Settings

Press and hold the **TEMP.** and **MAX/MIN** buttons at the same time for 5 seconds to enter calibration mode. The **CAL** icon will be displayed.

To proceed to the next calibration setting, press (do not hold) the **SET** button.

To exit and save the calibration setting, press the **LIGHT / SNOOZE** button.

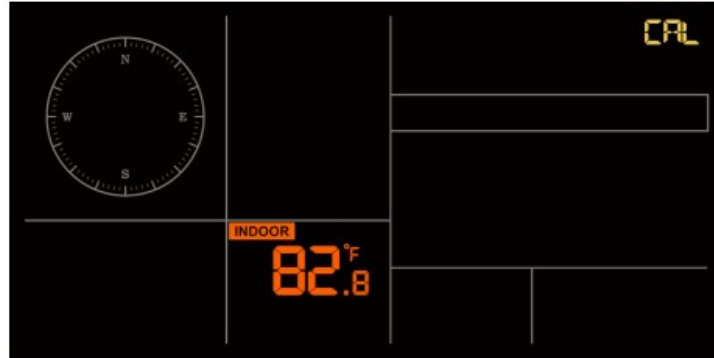

Figure 21

Figure 22 summarizes the set mode sequence and commands.

Command	Mode	Settings
TEMP. and MAX/MIN + 5 seconds	Enter Calibration Mode, Indoor Temperature	Press [WIND +] or [PRESSURE -] to adjust the indoor temperature up or down. To restore to factory default, press [ALARM].
[SET]	Indoor Humidity	Press [WIND +] or [PRESSURE -] to adjust the indoor humidity up or down. To restore to factory default, press [ALARM].
[SET]	Outdoor Temperature	Press [WIND +] or [PRESSURE -] to adjust the outdoor temperature up or down. To restore to factory default, press [ALARM].
[SET]	Outdoor Humidity	Press [WIND +] or [PRESSURE -] to adjust the outdoor humidity up or down. To restore to factory default, press [ALARM].

[SET]	Absolute Pressure	Press [WIND +] or [PRESSURE -] to adjust the absolute pressure up or down. To restore to factory default, press [ALARM]. Note: The absolute pressure calibration affects the relative pressure by the same amount. It is recommend you calibrate the relative pressure only, per Section 6.3.
[SET]	Wind Direction	Press [WIND +] or [PRESSURE -] to adjust the wind direction up or down. To restore to factory default, press [ALARM].
[SET]	Wind Speed Factor	Press [WIND +] or [PRESSURE -] to adjust the wind speed factor up or down. To restore to factory default, press [ALARM].
[SET]	Rain Factor	Press [WIND +] or [PRESSURE -] to adjust the rain factor up or down. To restore to factory default, press [ALARM].
[SET]*	Daily Rain	Press [WIND +] or [PRESSURE -] to adjust the daily rain up or down.
[SET]*	Monthly Rain	Press [WIND +] or [PRESSURE -] to adjust the monthly rain up or down.
[SET]*	Yearly Rain	Press [WIND +] or [PRESSURE -] to adjust the yearly rain up or down.
[SET]*	Total Rain	Press [WIND +] or [PRESSURE -] to adjust the total rain up or down.
[SET]	Exit calibration mode	

Figure 22

* Not available in earlier models

6.10.2 Calibration Ranges

The following table summarizes the permissible calibration ranges.

Parameter	Range
Indoor Temperature	± 9 °F
Indoor Humidity	± 9%
Outdoor Temperature	± 9 °F
Outdoor Humidity	± 9%
Absolute Pressure	± 10 hpa (± 2.95 inHg)
Wind Direction	± 180 °
Wind Speed Factor	0.5 to 1.5
Rain Factor	0.5 to 1.5

Figure 23

6.10.3 Calibration Discussion

The purpose of calibration is to fine tune or correct for any sensor error associated with the devices margin of error. Errors can occur due to electronic variation (example, the temperature sensor is a resistive thermal device or RTD, the humidity sensor is a capacitance device), mechanical variation, or degradation (wearing of moving parts, contamination of sensors).

Calibration is only useful if you have a known calibrated source you can compare it against, and is optional. This section discusses practices, procedures and sources for sensor calibration to reduce manufacturing and degradation errors. Do not compare your readings obtained from sources such as the internet, radio, television or newspapers. The purpose of your weather station is to measure conditions of your surroundings, which vary significantly from location to location.

Parameter	Type of Calibration	Default	Typical Calibration Source
Temperature	Offset	Current Value	Red Spirit or Mercury Thermometer (1)
Humidity	Offset	Current Value	Sling Psychrometer (2)
ABS Barometer	Offset	Current Value	Calibrated laboratory grade barometer
REL Barometer	Offset	Current Value	Local airport (3)
Wind Direction	Offset	Current Value	GPS, Compass (4)
Wind	Gain	1.00	Calibrated laboratory grade wind meter (5)
Rain	Gain	1.00	Sight glass rain gauge with an aperture of at least 4" (6)

Figure 24

- (1) Temperature errors can occur when a sensor is placed too close to a heat source (such as a building structure, the ground or trees).

To calibrate temperature, we recommend a mercury or red spirit (fluid) thermometer. Bi-metal (dial) and digital thermometers (from other weather stations) are not a good source and have their own margin of error. Using a local weather station in your area is also a poor source due to changes in location, timing (airport weather stations are only updated once per hour).

Place the sensor in a shaded, controlled environment next to the fluid thermometer, and allow the sensor to stabilize for 48 hours. Compare this temperature to the fluid thermometer and adjust the console to match the fluid thermometer.

- (2) Humidity is a difficult parameter to measure electronically and drifts over time due to contamination. In addition, location has an adverse affect on humidity readings (installation over dirt vs. lawn for example).

Official stations recalibrate or replace humidity sensors on a yearly basis. Due to manufacturing tolerances, the humidity is accurate to $\pm 5\%$. To improve this accuracy, the indoor and outdoor humidity can be calibrated using an accurate source, such as a sling psychrometer.

- (3) The display console displays two different pressures: absolute (measured) and relative (corrected to sea-level).

To compare pressure conditions from one location to another, meteorologists correct pressure to sea-level conditions. Because the air pressure decreases as you rise in altitude, the sea-level corrected pressure (the pressure your location would be at if located at sea-level) is generally higher than your measured pressure.

Thus, your absolute pressure may read 28.62 inHg (969 mb) at an altitude of 1000 feet (305 m), but the relative pressure is 30.00 inHg (1016 mb).

The standard sea-level pressure is 29.92 in Hg (1013 mb). This is the average sea-level pressure around the world. Relative pressure measurements greater than 29.92 inHg (1013 mb) are considered high pressure and relative pressure measurements less than 29.92 inHg are considered low pressure.

To determine the relative pressure for your location, locate an official reporting station near you (the internet is the best source for real time barometer conditions, such as Weather.gov, Weather.com or Wunderground.com), and set your weather station to match the official reporting station.

- (4) Only use this if you improperly installed the weather station sensor array, and did not point the direction reference to true north.
- (5) Wind speed is the most sensitive to installation constraints. The rule of thumb for properly installing a wind speed sensor is 4 x the distance of the tallest obstruction. For example, if your house is 20' tall and you mount the sensor on a 5' pole:

$$\text{Distance} = 4 \times (20 - 5)' = 60'.$$

Many installations are not perfect and installing the weather station on a roof can be difficult. Thus, you can

calibrate for this error with a wind speed multiplier.

In addition to the installation challenges, wind cup bearings (moving parts) wear over time.

Without a calibrated source, wind speed can be difficult to measure. We recommend using a calibrated wind meter (available from Ambient Weather) and a constant speed, high speed fan.

- (6) The rain collector is calibrated at the factory based on the funnel diameter. The bucket tips every 0.01” of rain (referred to as resolution). The accumulated rainfall can be compared to a sight glass rain gauge with an aperture of at least 4”. The following is a link to an accurate sight glass rain gauge:

<http://www.ambientweather.com/stpraga.html>

Make sure you periodically clean the rain gauge funnel.

6.11 Restoring the Console to Factory Default

To restore the console to factory default, perform the following steps:

1. Remove the power from the console by removing the batteries and disconnecting the AC adapter.
2. Apply power by connecting the AC adapter.
3. Wait for all of the segments to appear on the screen, as shown in Figure 14.
4. Press and hold the **WIND/+** and **PRESSURE/-** buttons at the same time until the console power up sequence is complete (about 5 seconds).
5. Replace the batteries.

6.12 Resynchronize Wireless Sensor

Press and hold the **LIGHT /SNOOZE** button for 5 seconds, and the console will re-register the wireless sensor.

6.13 Backlight Operation

6.13.1 With AC Adapter

The backlight can only be continuously on when the AC adapter is permanently on. When the AC adapter is disconnected, the backlight can be temporarily turned on.

Press the **LIGHT SNOOZE** button to adjust the brightness between High, Low and Off.

6.13.2 Without AC Adapter

To reduce power consumption, the console will sleep on battery power only, and will not send data to the Internet.

To temporarily turn on the back light for 15 seconds, press the **LIGHT SNOOZE** button.

6.14 Tendency Arrows

Tendency arrows allow you to quickly determine if temperature or pressure are rising and falling in a three hour update period, updated every 30 minutes.

Figure 25 defines the conditions for rising and falling pressure every 3 hours.



Tendency indicators	Condition	Humidity Change per 3 Hours	Temperature Change per 3 Hours
	Rising	Rising > 3%	Rising > 1° C / 2 °F
	Steady	Change ≤ ±3%	Change ≤ ± 1 ° C / 2 ° F
	Falling	Falling > 3%	Falling > 1° C / 2 °F

Figure 25

6.15 Wireless Signal Strength Indicator

The wireless signal strength displays reception quality. If no signal is lost, the signal strength indicator will display 5 bars. If the signal is lost once, four bars will be displayed, a shown in Figure 26.



Five Bars	Four Bars
	
No signal loss	Lost signal once

Figure 26

6.16 Weather Forecasting

The five weather icons are Sunny, Partly Cloudy, Cloudy, Rainy, Stormy and Snowy.

The forecast icon is based on the rate of change of barometric pressure. Please allow at least **one month** for the weather station to learn the barometric pressure over time.





Sunny	Partly Cloudy	Cloudy	Rainy	Stormy	Snowy
					
Pressure increases for a sustained period of time	Pressure increases slightly, or initial power up	Pressure decreases slightly	Pressure decreases for a sustained period of time	Pressure rapidly decreases	Pressure decreases for a sustained period of time and temperature is below freezing

Figure 27

6.16.1 Storm Alert

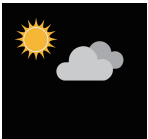
If there is a rapid drop in barometric pressure, the forecast icon will flash.

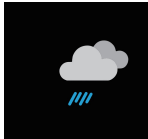
6.16.2 Weather Forecasting Description and Limitations

In general, if the rate of change of pressure increases, the weather is generally improving (sunny to partly cloudy). If the rate of change of pressure decreases, the weather is generally degrading (cloudy, rainy or stormy). If the rate of change is relatively steady, it will read partly cloudy.

The reason the current conditions do not match the forecast icon is because the forecast is a prediction 24-48 hours in advance. In most locations, this prediction is only 70% accurate and it is a good idea to consult the National Weather Service for more accurate weather forecasts. In some locations, this prediction may be less or more accurate. However, it is still an interesting educational tool for learning why the weather changes.

The National Weather Service (and other weather services such as Accuweather and The Weather Channel) have many tools at their disposal to predict weather conditions, including weather radar, weather models, and detailed mapping of ground conditions.

7. Glossary of Terms

Term	Definition
Absolute Barometric Pressure	<p>Absolute pressure is the measured atmospheric pressure and is a function of altitude, and to a lesser extent, changes in weather conditions.</p> <p>Absolute pressure is not corrected to sea-level conditions. <i>Refer to Relative Barometric Pressure.</i></p>
Accuracy	<p>Accuracy is defined as the ability of a measurement to match the actual value of the quantity being measured.</p>
Barometer	<p>A barometer is an instrument used to measure atmospheric pressure.</p>
Calibration	<p>Calibration is a comparison between measurements – one of known magnitude or correctness of one device (standard) and another measurement made in as similar a way as possible with a second device (instrument).</p>
Dew Point	<p>The dew point is the temperature at which a given parcel of humid air must be cooled, at constant barometric pressure, for water vapor to condense into water. The condensed water is called dew. The dew point is a saturation temperature.</p> <p>The dew point is associated with relative humidity. A high relative humidity indicates that the dew point is closer to the current air temperature. Relative humidity of 100% indicates the dew point is equal to the current temperature and the air is maximally saturated with water. When the dew point remains constant and temperature increases, relative humidity will decrease.</p>
Heat Index	<p>The Heat Index, sometimes referred to as the apparent temperature, is a measure of how hot it really feels when relative humidity is factored with the actual air temperature.</p> <p>To find the Heat Index temperature, look at the Heat Index chart below. As an example, if the air temperature is 96°F and the relative humidity is 65%, the heat index (how hot it feels) is 121°F.</p> <p>IMPORTANT: Since heat index values were devised for shady, light wind conditions, exposure to full sunshine can increase heat index values by up to 15°F. Also, strong winds, particularly with very hot, dry air, can be extremely hazardous.</p> <p>The Heat Index Chart shaded zone above 105°F shows a level that may cause increasingly severe heat disorders with continued exposure or physical activity.</p> <p>Heat Index is not calculated below 80°F.</p>

Term	Definition																																																																																																																																																																																																																																																																																																																																																																																																														
	<div style="display: flex; align-items: center;"> <table border="1" style="margin-right: 20px;"> <caption>Heat Index (Apparent Temperature)</caption> <thead> <tr> <th colspan="2"></th> <th colspan="16">Relative Humidity (%)</th> </tr> <tr> <th colspan="2"></th> <th colspan="16">°F</th> </tr> <tr> <th colspan="2"></th> <th>40</th><th>45</th><th>50</th><th>55</th><th>60</th><th>65</th><th>70</th><th>75</th><th>80</th><th>85</th><th>90</th><th>95</th><th>100</th> <th colspan="3"></th> </tr> </thead> <tbody> <tr> <th rowspan="16" style="writing-mode: vertical-rl; transform: rotate(180deg);">Air Temperature</th> <th>110</th> <td>136</td><td></td><td></td><td></td><td></td><td></td><td></td><td></td><td></td><td></td><td></td><td></td><td></td><td></td><td></td><td></td> <td colspan="3"></td> </tr> <tr> <th>108</th> <td>130</td><td>137</td><td></td><td></td><td></td><td></td><td></td><td></td><td></td><td></td><td></td><td></td><td></td><td></td><td></td><td></td><td></td> <td colspan="3"></td> </tr> <tr> <th>106</th> <td>124</td><td>130</td><td>137</td><td></td><td></td><td></td><td></td><td></td><td></td><td></td><td></td><td></td><td></td><td></td><td></td><td></td><td></td> <td colspan="3"></td> </tr> <tr> <th>104</th> <td>119</td><td>124</td><td>131</td><td>137</td><td></td><td></td><td></td><td></td><td></td><td></td><td></td><td></td><td></td><td></td><td></td><td></td><td></td> <td colspan="3"></td> </tr> <tr> <th>102</th> <td>114</td><td>119</td><td>124</td><td>130</td><td>137</td><td></td><td></td><td></td><td></td><td></td><td></td><td></td><td></td><td></td><td></td><td></td><td></td> <td colspan="3"></td> </tr> <tr> <th>100</th> <td>109</td><td>114</td><td>118</td><td>124</td><td>129</td><td>136</td><td></td><td></td><td></td><td></td><td></td><td></td><td></td><td></td><td></td><td></td><td></td> <td colspan="3"></td> </tr> <tr> <th>98</th> <td>105</td><td>109</td><td>113</td><td>117</td><td>123</td><td>128</td><td>134</td><td></td><td></td><td></td><td></td><td></td><td></td><td></td><td></td><td></td><td></td> <td colspan="3"></td> </tr> <tr> <th>96</th> <td>101</td><td>104</td><td>108</td><td>112</td><td>116</td><td>121</td><td>126</td><td>132</td><td></td><td></td><td></td><td></td><td></td><td></td><td></td><td></td><td></td> <td colspan="3"></td> </tr> <tr> <th>94</th> <td>97</td><td>100</td><td>103</td><td>106</td><td>110</td><td>114</td><td>119</td><td>124</td><td>129</td><td>135</td><td></td><td></td><td></td><td></td><td></td><td></td><td></td> <td colspan="3"></td> </tr> <tr> <th>92</th> <td>94</td><td>96</td><td>99</td><td>101</td><td>105</td><td>108</td><td>112</td><td>116</td><td>121</td><td>126</td><td>131</td><td></td><td></td><td></td><td></td><td></td><td></td> <td colspan="3"></td> </tr> <tr> <th>90</th> <td>91</td><td>93</td><td>95</td><td>97</td><td>100</td><td>103</td><td>106</td><td>109</td><td>113</td><td>117</td><td>122</td><td>127</td><td>132</td><td></td><td></td><td></td><td></td> <td colspan="3"></td> </tr> <tr> <th>88</th> <td>88</td><td>89</td><td>91</td><td>93</td><td>95</td><td>98</td><td>100</td><td>103</td><td>106</td><td>110</td><td>113</td><td>117</td><td>121</td><td></td><td></td><td></td><td></td> <td colspan="3"></td> </tr> <tr> <th>86</th> <td>85</td><td>87</td><td>88</td><td>89</td><td>91</td><td>93</td><td>95</td><td>97</td><td>100</td><td>102</td><td>105</td><td>108</td><td>112</td><td></td><td></td><td></td><td></td> <td colspan="3"></td> </tr> <tr> <th>84</th> <td>83</td><td>84</td><td>85</td><td>86</td><td>88</td><td>89</td><td>90</td><td>92</td><td>94</td><td>96</td><td>98</td><td>100</td><td>103</td><td></td><td></td><td></td><td></td> <td colspan="3"></td> </tr> <tr> <th>82</th> <td>81</td><td>82</td><td>83</td><td>84</td><td>84</td><td>85</td><td>86</td><td>88</td><td>89</td><td>90</td><td>91</td><td>93</td><td>95</td><td></td><td></td><td></td><td></td> <td colspan="3"></td> </tr> <tr> <th>80</th> <td>80</td><td>80</td><td>81</td><td>81</td><td>82</td><td>82</td><td>83</td><td>84</td><td>84</td><td>85</td><td>86</td><td>86</td><td>87</td><td></td><td></td><td></td><td></td> <td colspan="3"></td> </tr> </tbody> </table> <div style="margin-left: 20px;"> <p>With Prolonged Exposure and/or Physical Activity</p> <table border="1"> <tr> <th style="background-color: #cccccc;">Extreme Danger</th> <td>Heat stroke or sunstroke highly likely</td> </tr> <tr> <th style="background-color: #cccccc;">Danger</th> <td>Sunstroke, muscle cramps, and/or heat exhaustion likely</td> </tr> <tr> <th style="background-color: #cccccc;">Extreme Caution</th> <td>Sunstroke, muscle cramps, and/or heat exhaustion possible</td> </tr> <tr> <th style="background-color: #cccccc;">Caution</th> <td>Fatigue possible</td> </tr> </table> </div> </div>			Relative Humidity (%)																		°F																		40	45	50	55	60	65	70	75	80	85	90	95	100				Air Temperature	110	136																			108	130	137																			106	124	130	137																		104	119	124	131	137																	102	114	119	124	130	137																100	109	114	118	124	129	136															98	105	109	113	117	123	128	134														96	101	104	108	112	116	121	126	132													94	97	100	103	106	110	114	119	124	129	135											92	94	96	99	101	105	108	112	116	121	126	131										90	91	93	95	97	100	103	106	109	113	117	122	127	132								88	88	89	91	93	95	98	100	103	106	110	113	117	121								86	85	87	88	89	91	93	95	97	100	102	105	108	112								84	83	84	85	86	88	89	90	92	94	96	98	100	103								82	81	82	83	84	84	85	86	88	89	90	91	93	95								80	80	80	81	81	82	82	83	84	84	85	86	86	87								Extreme Danger	Heat stroke or sunstroke highly likely	Danger	Sunstroke, muscle cramps, and/or heat exhaustion likely	Extreme Caution	Sunstroke, muscle cramps, and/or heat exhaustion possible	Caution	Fatigue possible
		Relative Humidity (%)																																																																																																																																																																																																																																																																																																																																																																																																													
		°F																																																																																																																																																																																																																																																																																																																																																																																																													
		40	45	50	55	60	65	70	75	80	85	90	95	100																																																																																																																																																																																																																																																																																																																																																																																																	
Air Temperature	110	136																																																																																																																																																																																																																																																																																																																																																																																																													
	108	130	137																																																																																																																																																																																																																																																																																																																																																																																																												
	106	124	130	137																																																																																																																																																																																																																																																																																																																																																																																																											
	104	119	124	131	137																																																																																																																																																																																																																																																																																																																																																																																																										
	102	114	119	124	130	137																																																																																																																																																																																																																																																																																																																																																																																																									
	100	109	114	118	124	129	136																																																																																																																																																																																																																																																																																																																																																																																																								
	98	105	109	113	117	123	128	134																																																																																																																																																																																																																																																																																																																																																																																																							
	96	101	104	108	112	116	121	126	132																																																																																																																																																																																																																																																																																																																																																																																																						
	94	97	100	103	106	110	114	119	124	129	135																																																																																																																																																																																																																																																																																																																																																																																																				
	92	94	96	99	101	105	108	112	116	121	126	131																																																																																																																																																																																																																																																																																																																																																																																																			
	90	91	93	95	97	100	103	106	109	113	117	122	127	132																																																																																																																																																																																																																																																																																																																																																																																																	
	88	88	89	91	93	95	98	100	103	106	110	113	117	121																																																																																																																																																																																																																																																																																																																																																																																																	
	86	85	87	88	89	91	93	95	97	100	102	105	108	112																																																																																																																																																																																																																																																																																																																																																																																																	
	84	83	84	85	86	88	89	90	92	94	96	98	100	103																																																																																																																																																																																																																																																																																																																																																																																																	
	82	81	82	83	84	84	85	86	88	89	90	91	93	95																																																																																																																																																																																																																																																																																																																																																																																																	
	80	80	80	81	81	82	82	83	84	84	85	86	86	87																																																																																																																																																																																																																																																																																																																																																																																																	
Extreme Danger	Heat stroke or sunstroke highly likely																																																																																																																																																																																																																																																																																																																																																																																																														
Danger	Sunstroke, muscle cramps, and/or heat exhaustion likely																																																																																																																																																																																																																																																																																																																																																																																																														
Extreme Caution	Sunstroke, muscle cramps, and/or heat exhaustion possible																																																																																																																																																																																																																																																																																																																																																																																																														
Caution	Fatigue possible																																																																																																																																																																																																																																																																																																																																																																																																														
HectoPascals (hPa)	Pressure units in SI (international system) units of measurement. Same as millibars (1 hPa = 1 mbar)																																																																																																																																																																																																																																																																																																																																																																																																														
Hygrometer	A hygrometer is a device that measures relative humidity. Relative humidity is a term used to describe the amount or percentage of water vapor that exists in air.																																																																																																																																																																																																																																																																																																																																																																																																														
Inches of Mercury (inHg)	Pressure in Imperial units of measure. 1 inch of mercury = 33.86 millibars																																																																																																																																																																																																																																																																																																																																																																																																														
Rain Gauge	A rain gauge is a device that measures liquid precipitation (rain), as opposed to solid precipitation (snow gauge) over a set period of time. All digital rain gauges are self emptying or self dumping (also referred to as tipping rain gauge). The precision of the rain gauge is based on the volume of rain per emptying cycle.																																																																																																																																																																																																																																																																																																																																																																																																														
Range	Range is defined as the amount or extent a value can be measured.																																																																																																																																																																																																																																																																																																																																																																																																														
Relative Barometric Pressure	Measured barometric pressure relative to your location or ambient conditions.																																																																																																																																																																																																																																																																																																																																																																																																														
Resolution	Resolution is defined as the number of significant digits (decimal places) to which a value is being reliably measured.																																																																																																																																																																																																																																																																																																																																																																																																														
Solar Radiation	A solar radiation sensor measures solar energy from the sun. Solar radiation is radiant energy emitted by the sun from a nuclear fusion reaction that creates electromagnetic energy. The spectrum of solar radiation is close to that of a black object with a temperature of about 5800 K. About half of the radiation is in the visible short-wave part of the electromagnetic spectrum. The other half is mostly in the near-infrared part, with some in the ultraviolet part of the spectrum.																																																																																																																																																																																																																																																																																																																																																																																																														
Thermometer	A thermometer is a device that measures temperature. Most digital thermometers are resistive thermal devices (RTD). RTDs measure changes in temperature as a function of electrical resistance.																																																																																																																																																																																																																																																																																																																																																																																																														
Wind Vane	A wind vane is a device that measures the direction of the wind. The wind vane is usually combined with the anemometer. Wind direction is the direction from which the wind is blowing.																																																																																																																																																																																																																																																																																																																																																																																																														

Figure 28

8. Specifications

8.1 Wireless Specifications

- Line of sight wireless sensor array RF transmission (in open air): 330 feet, 100 feet under most conditions
- Update Rate: Outdoor Sensor: 16 seconds, Indoor Sensor: 64 seconds
- Sensor Array RF Frequency: 915 MHz

8.2 Measurement Specifications

The following table provides the specifications for the measured parameters.

Measurement	Range	Accuracy	Resolution
Indoor Temperature	14 to 140 °F	± 2 °F	0.1 °F
Outdoor Temperature	-40 to 149 °F (lithium batteries) -23 to 140 °F (alkaline batteries)	± 2 °F	0.1 °F
Indoor Humidity	10 to 99%	± 5%	1 %
Outdoor Humidity	10 to 99%	± 5%	1 %
Barometric Pressure	8.85 to 32.50 inHg	± 0.08 inHg (within range of 27.13 to 32.50 inHg)	0.01 inHg
Light	0 to 200,000 Lux	± 15%	1 Lux
Rain	0 to 394 in.	± 5%	0.01 in
Wind Direction	0 - 360 °	± 10°	1°
Wind Speed	0 to 100 mph (operational)	± 2.2 mph or 10% (whichever is greater)	1.4 mph

Figure 29

8.3 Power Consumption

- Base station : 5V DC Adaptor (included), Power Consumption: 0.5 Watts
- Base station: 3 x AAA batteries (not included)
- Outdoor sensor array: 2 x AA batteries (not included). The primary power source is the solar panel. The batteries provide backup power when there is limited solar energy.

9. Maintenance

1. Clean the rain gauge once every 3 months. Rotate the funnel counter-clockwise and lift to expose the rain gauge mechanism, and clean with a damp cloth. Remove any dirt, debris and insects. If bug infestation is an issue, spray the array lightly with insecticide.

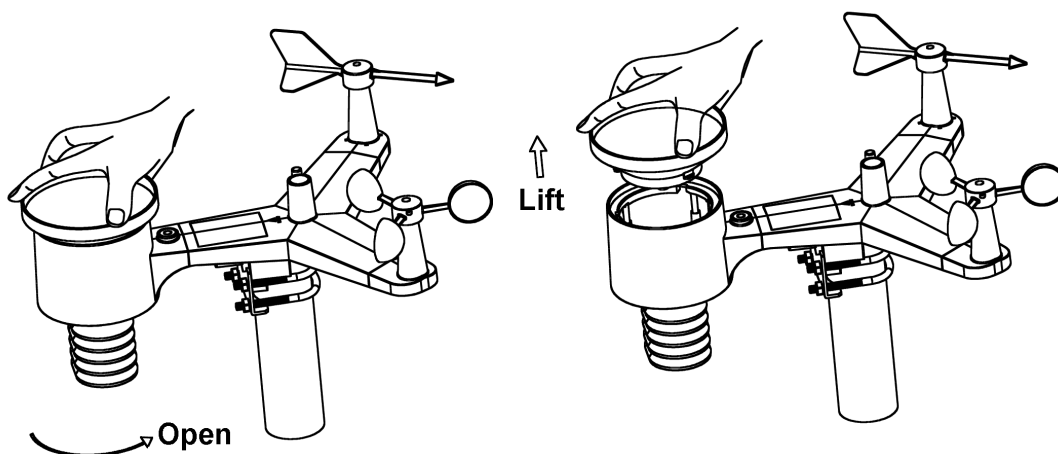

Figure 30

2. Clean the solar radiation sensor and solar panel every 3 months with damp cloth.
3. Replace batteries every 1-2 years. If left in too long, the batteries may leak due to environmental challenges. In harsh environments, inspect the batteries every 3 months (when cleaning the solar panel).

4. When replacing the batteries, apply a corrosion preventive compound on the battery terminals, available at Amazon and most hardware stores.
5. In snowy environments, spray the top of the weather station with anti-icing silicon spray to prevent snow build up.

10. Troubleshooting Guide

If your question is not answered here, you can contact us as follows:

1. Email Support: support@ambientweather.com
2. Technical Support: 480-346-3380 (M-F 8am to 4pm Arizona Time)

Problem	Solution
Outdoor sensor array does not communicate to the display console.	<p>The sensor array may have initiated properly and the data is registered by the console as invalid, and the console must be reset. Press the reset button as described in Figure 1.</p> <p>With an open ended paperclip, press the reset button for 3 seconds to completely discharge the voltage.</p> <p>Take out the batteries and wait one minute, while covering the solar panel to drain the voltage.</p> <p>Put batteries back in and resync the console (Section 6.12) with the sensor array about 10 feet away.</p> <p>The LED next to the battery compartment will flash every 16 seconds. If the LED is not flashing every 16 seconds...</p> <p>Replace the batteries in the outside sensor array.</p> <p>If the batteries were recently replaced, check the polarity. If the sensor is flashing every 16 seconds, proceed to the next step.</p> <p>There may be a temporary loss of communication due to reception loss related to interference or other location factors,</p> <p>or the batteries may have been changed in the sensor array and the console has not been reset. The solution may be as simple as powering down and up the console (remove AC power and batteries, wait 10 seconds, and reinsert AC power and batteries).</p>
Temperature sensor reads too high in the day time.	<p>Make certain that the sensor array is not too close to heat generating sources or strictures, such as buildings, pavement, walls or air conditioning units.</p> <p>Use the calibration feature to offset installation issues related to radiant heat sources. Reference Section 6.10.</p>
Relative pressure does not agree with official reporting station	<p>You may be viewing the absolute pressure, not the relative pressure.</p> <p>Select the relative pressure. Make sure you properly calibrate the sensor to an official local weather station. Reference Section 6.4 for details.</p>
Rain gauge reports rain when it is not raining	<p>An unstable mounting solution (sway in the mounting pole) may result in the tipping bucket incorrectly incrementing rainfall. Make sure you have a stable, level mounting solution.</p>
Wind Vane does not spin as freely as the wind cups.	<p>This is by design. The dampening prevents the wind vane from spinning with the slightest breeze, which will result in variable wind all of the time. The added resistance allows the wind vane to change direction with 2 – 3 mph, providing a much better wind direction tracking.</p>
Time off by increments of an hour, or date is off by one day.	<p>The time zone is entered incorrectly. Reference Section 6.3.</p>

Figure 31

11. Accessories

The following accessories are available for this weather station at www.AmbientWeather.com.

Accessory	Description
Ambient Weather Mounting Solutions	Ambient Weather provides the most comprehensive mounting solutions for weather stations, including tripods, pole extensions, pole mounting kits, guy wires, ground stakes and more.
WS-1900A-C Display Console	Add as many display consoles as you like to your weather station.

Figure 32

12. Liability Disclaimer

Please help in the preservation of the environment and return used batteries to an authorized depot. The electrical and electronic wastes contain hazardous substances. Disposal of electronic waste in wild country and/or in unauthorized grounds strongly damages the environment.

Reading the “User manual” is highly recommended. The manufacturer and supplier cannot accept any responsibility for any incorrect readings and any consequences that occur should an inaccurate reading take place.

This product is designed for use in the home only as indication of weather conditions. This product is not to be used for medical purposes or for public safety information.

The specifications of this product may change without prior notice.

This product is not a toy. Keep out of the reach of children.

No part of this manual may be reproduced without written authorization of the manufacturer.

Ambient, LLC WILL NOT ASSUME LIABILITY FOR INCIDENTAL, CONSEQUENTIAL, PUNITIVE, OR OTHER SIMILAR DAMAGES ASSOCIATED WITH THE OPERATION OR MALFUNCTION OF THIS PRODUCT.

13. FCC Statement

Statement according to FCC part 15.19:

This device complies with part 15 of the FCC rules. Operation is subject to the following two conditions:

1. This device may not cause harmful interference.
2. This device must accept any interference received, including interference that may cause undesired operation.

Statement according to FCC part 15.21:

Modifications not expressly approved by this company could void the user's authority to operate the equipment.

Statement according to FCC part 15.105:

NOTE: This equipment has been tested and found to comply with the limits for a Class B digital device, pursuant to Part 15 of the FCC Rules. These limits are designed to provide reasonable protection against harmful interference in a residential installation. This equipment generates, uses and can radiate radio frequency energy and, if not installed and used in accordance with the instructions, may cause harmful interference to radio communications.

However, there is no guarantee that interference will not occur in a particular installation. If this equipment does cause harmful interference to radio or television reception, which can be determined by turning the equipment off and on, the user is encouraged to try to correct the interference by one or more of the following measures:

- Reorient or relocate the receiving antenna.
- Increase the separation between the equipment and receiver.
- Connect the equipment into an outlet on a circuit different from that to which the receiver is connected.
- Consult the dealer or an experienced radio/TV technician for help.

14. Warranty Information

Ambient, LLC provides a 1-year limited warranty on this product against manufacturing defects in materials and workmanship.

This limited warranty begins on the original date of purchase, is valid only on products purchased and only to the original purchaser of this product. To receive warranty service, the purchaser must contact Ambient, LLC for problem determination and service procedures.

Warranty service can only be performed by a Ambient, LLC. The original dated bill of sale must be presented upon request as proof of purchase to Ambient, LLC.

Your Ambient, LLC warranty covers all defects in material and workmanship with the following specified exceptions: (1) damage caused by accident, unreasonable use or neglect (lack of reasonable and necessary maintenance); (3) damage resulting from failure to follow instructions contained in your owner's manual; (4) damage resulting from the performance of repairs or alterations by someone other than an authorized Ambient, LLC authorized service center; (5) units used for other than personal use (6) applications and uses that this product was not intended (7) the products inability to receive a signal due to any source of interference or metal obstructions and (8) extreme acts of nature, such as lightning strikes or floods.

This warranty covers only actual defects within the product itself, and does not cover the cost of installation or removal from a fixed installation, normal set-up or adjustments, claims based on misrepresentation by the seller or performance variations resulting from installation-related circumstances.

15. California Prop 65

WARNING: Use of the Ambient Weather Products can expose you to chemicals, including lead and lead compounds, which are known to the State of California to cause cancer and bisphenol A (BPA), and phthalates DINP and/or DEHP, which are known to the State of California to cause birth defects or other reproductive harm.

Can I Trust that Ambient Weather Products are Safe Despite this Warning?

In 1986, California voters approved the Safe Drinking Water and Toxic Enforcement Act known as Proposition 65 or Prop 65. The purpose of Proposition 65 is to ensure that people are informed about exposure to chemicals known by the State of California to cause cancer, birth defects and/or other reproductive harm. A company with ten or more employees that operates within the State of California (or sells products in California) must comply with the requirements of Proposition 65. To comply, businesses are: (1) prohibited from knowingly discharging listed chemicals into sources of drinking water; and (2) required to provide a "clear and reasonable" warning before knowingly and intentionally exposing anyone to a listed chemical. Proposition 65 mandates that the Governor of California maintain and publish a list of chemicals that are known to cause cancer, birth defects and/or other reproductive harm. The [Prop 65 list](#), which must be updated annually, includes over 1,000 chemicals, including many that are commonly used in the electronics industry.

Although our manufacturing process is "lead-free" and RoHS compliant, it remains possible that trace amounts of lead could be found in components or subassemblies of Ambient Weather Products. Bisphenol A (BPSA) could conceivably be present in minute amounts in our plastic housings, lenses, labels or adhesives, and DEHP & DINP (phthalates) could possibly be found in PVC wire coatings of our cables, housings, and power cords. Unlike RoHS, Prop 65 does not establish a specific threshold for reporting on the substances of concern and instead sets forth a much less definitive standard requiring that the business demonstrate with certainty that there is "no significant risk" resulting from exposure. With respect to carcinogens, the "no significant risk" level is defined as the level which is calculated to result in not more than one excess case of cancer in 100,000 individuals exposed over a 70-year lifetime. In other words, if you are exposed to the chemical in question at this level every day for 70 years, theoretically, it will increase your chances of getting cancer by no more than 1 case in 100,000 individuals so exposed. With respect to reproductive toxicants, the "no significant risk" level is defined as the level of exposure which, even if multiplied by 1,000, will not produce birth defects or other reproductive harm. In other words, the level of exposure is below the "no observable effect level," divided by 1,000. (The "no observable effect level" is the highest dose level which has not been associated with observable reproductive harm in humans or test animals.)

Proposition 65 does not clarify whether exposure is to be measured only in normal operation, or in the event of misuse such as intentionally damaging, incinerating or consuming an Ambient Weather Product or component and Ambient Weather has not attempted to evaluate the level of exposure.

A Proposition 65 warning means one of two things: (1) the business has evaluated the exposure and has concluded that it exceeds the "no significant risk level"; or (2) the business has chosen to provide a warning simply based on its knowledge about the presence of a listed chemical without attempting to evaluate the exposure. The California government has itself clarified that "The fact that a product bears a Proposition 65 warning does not mean by itself that the product is unsafe." The government has also explained, "You could think of Proposition 65 more as a 'right to know' law than a pure product safety law."

While using Ambient Weather Products as intended, we believe any potential exposure would be negligible or well within the "no significant risk" range. However, to ensure compliance with California law and our customers' right to know, we have elected to place the Proposition 65 warning signs on Ambient Weather Products.

For further information about California's Proposition 65, please visit <https://oehha.ca.gov/prop65/background/p65plain.html>

