Ambient Weather WS-3000-X8 Thermo-Hygrometer, Dew Point, Heat Index Wireless Monitor with Alarming, and Radio Controlled Clock User Manual



Table of Contents

1	Introduction.....	3
2	Getting Started	3
2.1	Parts List.....	3
2.2	Recommend Tools.....	3
2.3	Thermo-Hygrometer Sensor Set Up.....	3
2.4	Display Console Set Up	5
2.4.1	Display Console Layout.....	6
2.4.2	Sensor Operation Verification	6
3	Remote Sensor Installation	7
4	Console Operation.....	7
4.1	Setup Mode	8
4.1.1	Display Selection	9
4.1.2	Time Format.....	10
4.1.3	Date Format.....	10
4.1.4	Date and Time Format.....	10
4.1.5	Temperature Units of Measure.....	11
4.1.6	Sensor Labeling.....	11
4.2	Calibration.....	12
4.2.1	Notes about Calibration.....	14
4.2.2	Humidity Calibration Methods.....	14
4.2.3	Temperature Calibration Methods.....	15
4.3	Min / Max and Alarm Mode.....	15
4.3.1	Min / Max.....	15
4.3.2	Alarms.....	16
4.4	Factory Settings.....	19
4.4.1	Factory Reset.....	19
4.4.2	Clear Max/Min Values	20
4.4.3	Re-register Sensors.....	20
4.4.4	About.....	20
4.4.5	Language.....	21
4.4.6	Back Light.....	21
5	Other Features.....	22
5.1	Radio Controlled Clock (RCC).....	22
5.2	SD Card Export and Firmware Updates.....	22
5.2.1	SD Data Export	23
5.2.2	Firmware Updates	23
5.3	PC Software.....	23
5.3.1	Getting Started	24
5.3.2	Time, Date and Display Setup.....	25
5.3.3	Alarm Settings.....	26

5.3.4	Calibration.....	27
5.3.5	SDCard File.....	27
6	Best Practices for Wireless Communication	29
7	Glossary of Terms	30
8	Accessories	30
9	Specifications.....	30
9.1	Wireless Specifications	30
9.2	Measurement Specifications.....	31
9.3	Power Consumption	31
10	Optional Sensors.....	31
11	Troubleshooting Guide	31
12	Liability Disclaimer.....	33
13	FCC Statement.....	33
14	Warranty Information	34
15	California Prop 65	34

1 Introduction

Thank you for your purchase of the Ambient Weather WS-3000 Thermo-Hygrometer, Dew Point, Heat Index Wireless Monitor with Graphing, Alarming, and Radio-Controlled Clock. The following user guide provides step by step instructions for installation, operation and troubleshooting.

To download the latest manual and additional troubleshooting tips, please visit:

<https://ambientweather.com/faqs/question/tags/tag/WS-3000-X8/>

2 Getting Started

 **Note:** The power up sequence must be performed in the order shown in this section (insert batteries in the remote transmitter(s) first, Display Console second).

The WS-3000 weather station consists of a display console (receiver), and up to 5 thermo-hygrometers (remote transmitters), based on your order configuration.

2.1 Parts List

QTY	Item
1	Display Console Frame Dimensions (LxHxW): 4.5 x 3.75 x 1.5 in LCD Dimensions (LxW): 3.75 x 2.25"
*	Thermo-hygrometer transmitter (WH31) Dimensions (LxHxW): 4.75" x 1.5" x 0.6"
1	USB Cable for PC Connection

* 1,2,3,4, or 5, based on your order configuration.

2.2 Recommend Tools

Hammer and nail for hanging remote thermo-hygrometer transmitter(s).

2.3 Thermo-Hygrometer Sensor Set Up

 **Note:** Do not use rechargeable batteries. We recommend fresh alkaline batteries for outdoor temperature ranges between -4 °F and 140 °F and fresh lithium batteries for outdoor temperature ranges between -40 °F and 140 °F.

1. Remove the battery door on the back of the transmitter(s) by sliding down the battery door, as shown in Figure 1 .

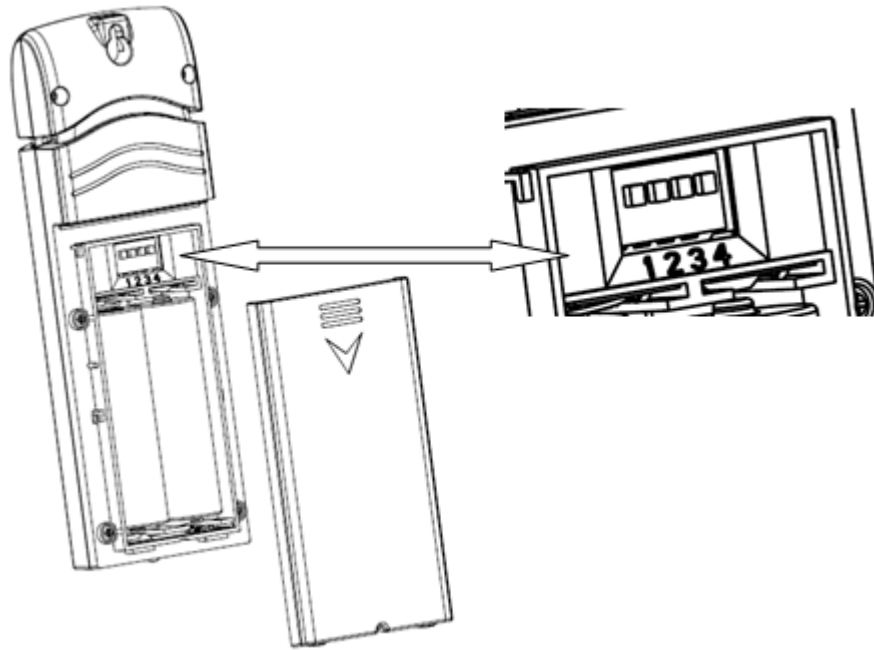

Figure 1

2. **BEFORE** inserting the batteries, locate the dip switches on the inside cover of the lid of the transmitter.
3. **Channel Number:** The WS-3000 supports up to eight transmitters, and includes three transmitters. To set each channel number (the default is Channel 1), change Dip Switches 1, 2 and 3, as referenced in Figure 2.
4. **Temperature Units of Measure:** To change the transmitter display units of measure (°F vs. °C), change Dip Switch 4, as referenced in Figure 2.

Switch in down position. Switch in up position.

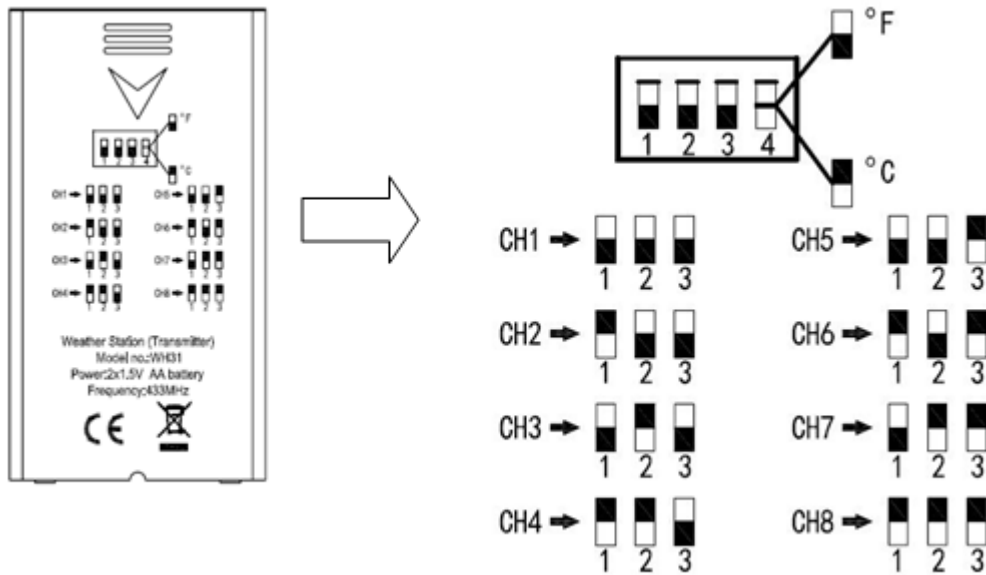

Figure 2

5. Insert two AA batteries.
6. Verify the correct channel number (CH) and temperature units of measure (°F vs. °C) are on the display, as shown in Figure 3.



Figure 3

- (1) temperature
- (2) temperature units (°F vs. °C)
- (3) channel number
- (4) relative humidity

7. Close the battery door.
8. Repeat for the additional remote transmitters, verifying each remote is on a different channel.

2.4 Display Console Set Up

1. Move the transmitters(s) about 5 to 10' away from the display console (if the transmitters are too close, they may not be received by the display console). With multiple transmitters, make sure all transmitters are powered up and displaying different channels on the display.
2. Connect the console to AC power with the included AC adapter (Figure 4).

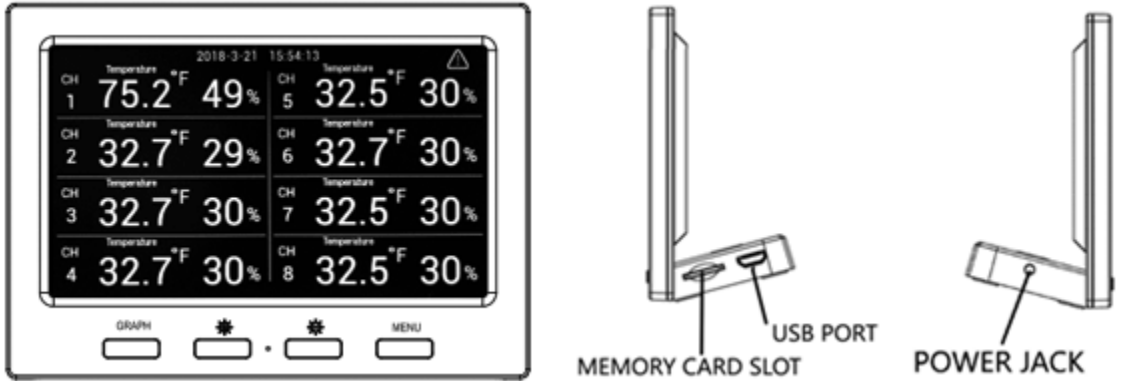

Figure 4

If the remotes do not update, please reference the troubleshooting guide in Section 10.

2.4.1 Display Console Layout

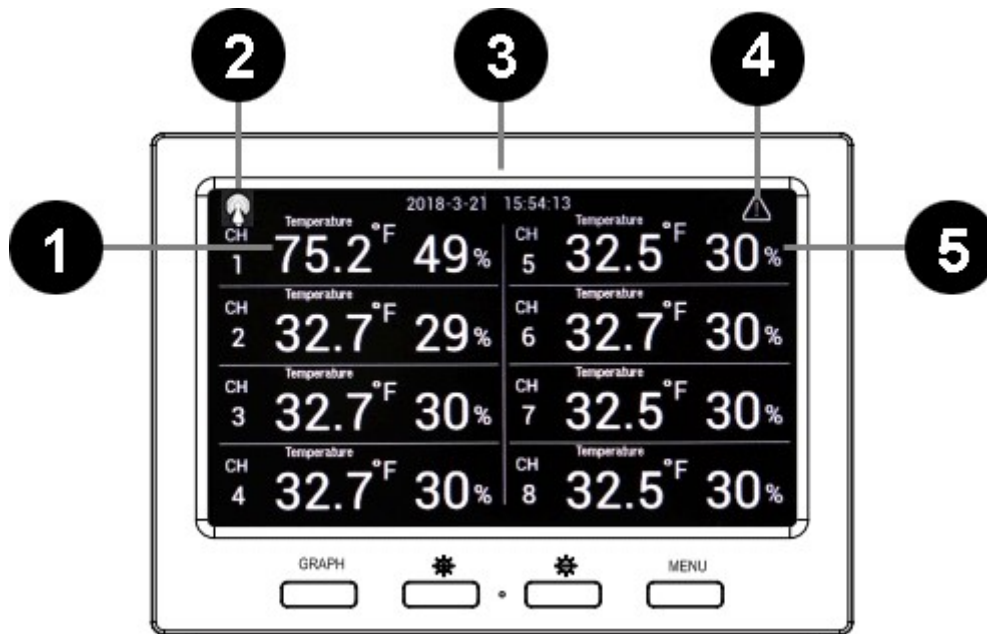

Figure 5

No	Description	No	Description
1	Temperature/Dew point/heat index	4	Alarm Icon.
2	Radio Controlled Clock reception icon.	5	Humidity
3	Date and time.		

2.4.2 Sensor Operation Verification

Verify the humidity sensors match closely with all of the sensors in the same location (about 5 to 10’

apart). The sensors should agree within 10% (the accuracy is $\pm 5\%$). Allow about 30 minutes for all sensors to stabilize. The humidity can be adjusted or calibrated later to match each other a known source.

Verify the temperature sensors match closely with all of the sensors in the same location (about 5 to 10' apart). The sensors should be within 4°F (the accuracy is $\pm 2^\circ\text{F}$). Allow about 30 minutes for all sensors to stabilize. The temperature can be adjusted or calibrated later to match each other or a known source.

3 Remote Sensor Installation

If you mount one or more of the sensors outside, it is recommended you mount the sensor in a shaded area. Direct sunlight and radiant heat sources will result in inaccurate temperature readings. Although the sensors are water resistant, it is best to mount in a well-protected area, such as under an eave. Use a screw to affix the remote sensor to the wall, as shown in Figure 6.

Alternately, you can hang the sensor with fishing wire or a string. This insures the sensor does not come into contact with any radiant heat source.

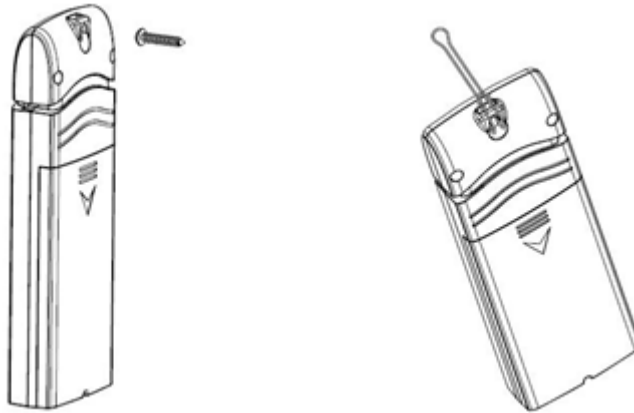

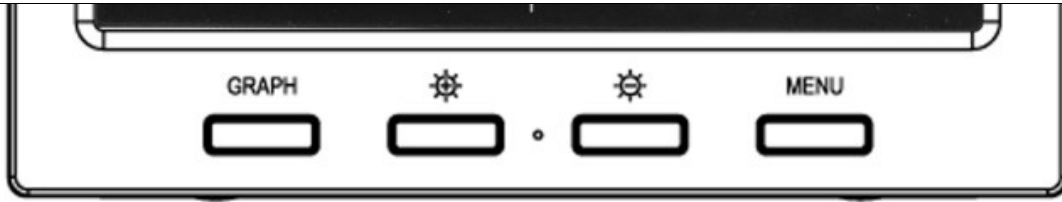

Figure 6

4 Console Operation

 **Note:** The console has four buttons for easy operation: **Graph**, **Brightness +**, **Brightness -** and **Menu**.





Icon	Description
GRAPH	Graph key Press = Switch to display graph of Temperature/Dew point/heat index/humidity for all sensors Hold = Removes graph from display and displays channels 1-8 simultaneously
	Brightness control key Press this key to increase the brightness
	Brightness control key Press this key to decrease the brightness
MENU	Menu Key Press this key to enter menu and scroll to different modes

Figure 7

4.1 Setup Mode

In the Normal mode, press the **MENU** key once to enter Setup Mode.

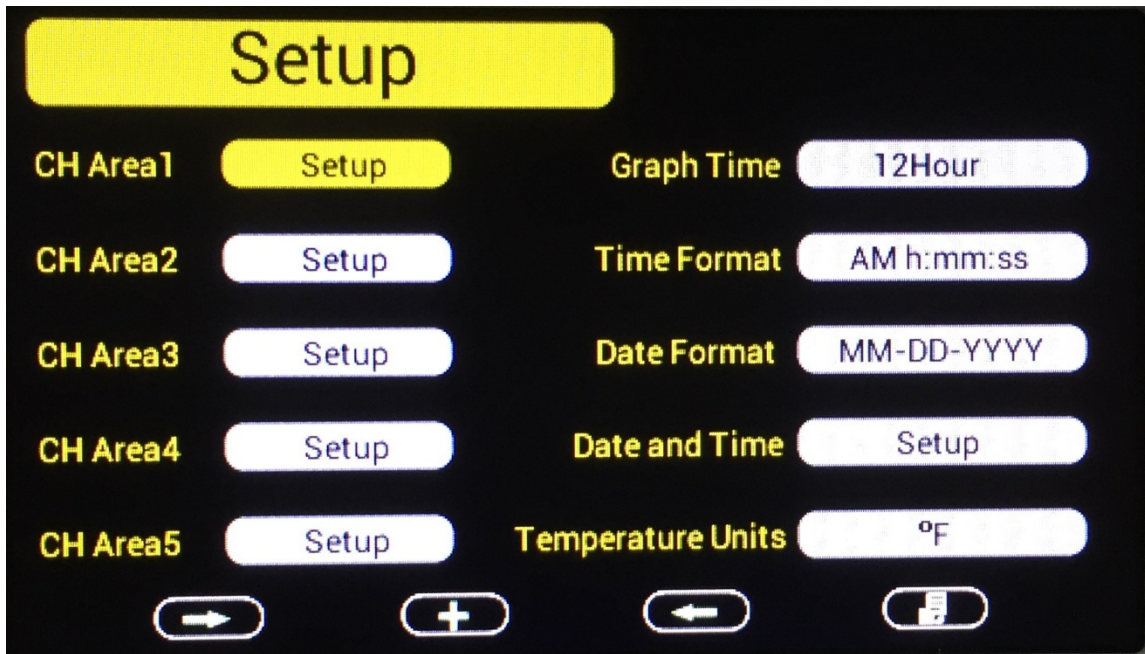

Icon	Description
------	-------------







	Scroll right key Press this key to scroll down/right.
	Selection key Press this key to select and enter the option.
	Scroll left key Press this key to scroll up/left.
	Mode key Press this key to enter to next mode

Figure 8

4.1.1 Display Selection

You can customize or even scroll between various parameters within each one of the Channel areas.

Scroll  to selected channel area (1-5), and press the plus  key to modify the home display screen area:

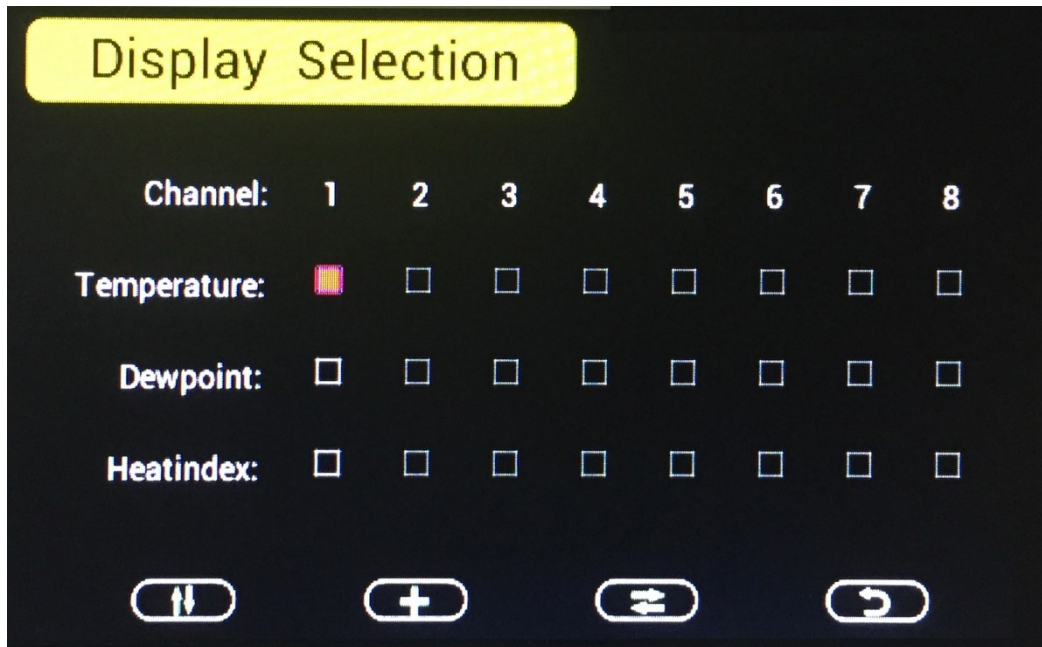







Icon	Description
	Scroll up/down key Press this key to scroll down/up.
	Selection key Press this key to select and enter the option.
	Scroll right/left key Press this key to scroll right/left.
	Return key Press this key to back to Setup main menu.



Figure 9

To modify the display parameter, press the up/down  and left/right  keys to move the blue cursor to a sensor channel number (1-8) and parameter (temperature, dew point, heat index). Press the  key to display this channel and parameter in the selected area on the main screen.



For example, if you wish to display Channel 1 Dew Point in the CH Area 1, highlight the Channel 1 Dewpoint field.

If you wish to toggle both channel 1 temperature and channel 1 dew point, highlight both the Channel 1 Temperature and Channel 1 Dew Point (reference Figure 9), and the screen will toggle between the channel 1 temperature and dew point on the main screen once every 3 seconds.

4.1.2 Time Format

To change the Time Format on the main display, scroll  to the Time Format, and select the  key to change between AM h:mm:ss, hh:mm:ss AM (12 hour time format) and h:mm:ss (24 hour time format)

4.1.3 Date Format

To change the Date Format on the main display, scroll  to the Date Format, and select the  key to change between MM-DD-YYYY, DD-MM-YYYY and YYYY-MM-DD.

4.1.4 Date and Time Format

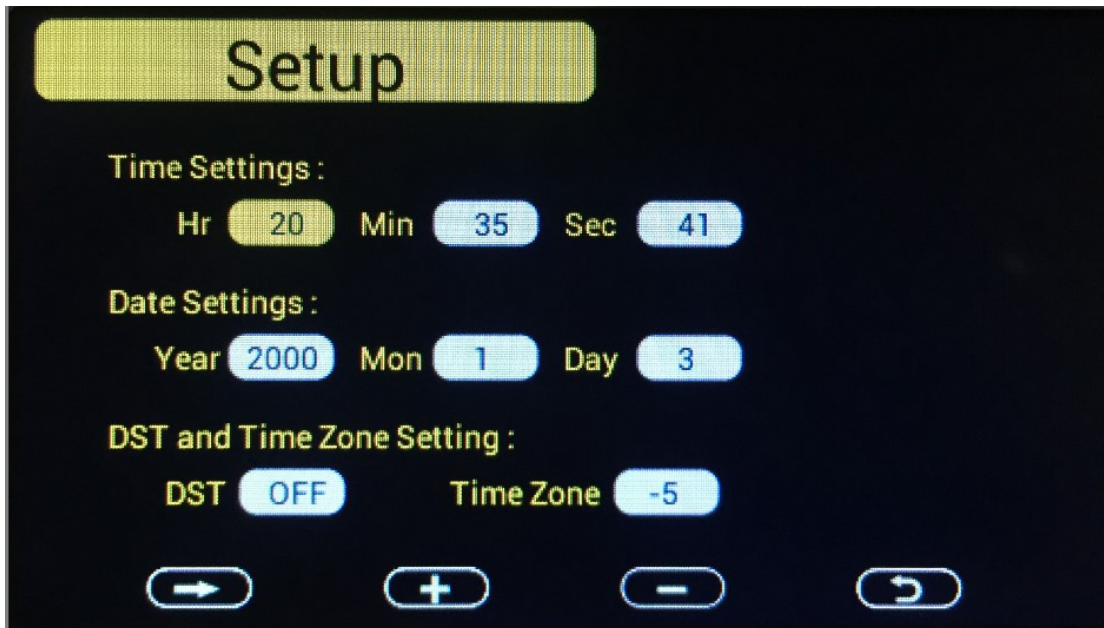





Figure 10

The console receives the radio controlled time signal from any one of the wireless sensors. The time and date will set automatically, and adjust for Daylight Savings Time (DST). To work properly, you must enter the time zone and DST. You can also manually enter the time.

To manually change the time and data settings, scroll  to the field you wish to change, and press the  or  key to adjust up or down.



Turn **ON** the DST setting, unless you reside in Arizona or Hawaii, which do not observe Daylight Savings Time.

Adjust your time zone according to the table below:

Hours from GMT	Time Zone	Cities
-12	IDLW: International Date Line West	---
-11	NT: Nome	Nome, AK
-10	AHST: Alaska-Hawaii Standard CAT: Central Alaska HST: Hawaii Standard	Honolulu, HI
-9	YST: Yukon Standard	Yukon Territory
-8	PST: Pacific Standard	Los Angeles, CA, USA
-7	MST: Mountain Standard	Denver, CO, USA
-6	CST: Central Standard	Chicago, IL, USA
-5	EST: Eastern Standard	New York, NY, USA
-4	AST: Atlantic Standard	Caracas
-3	---	São Paulo, Brazil
-2	AT: Azores	Azores, Cape Verde Islands
-1	WAT: West Africa	---
0	GMT: Greenwich Mean WET: Western European	London, England
1	CET: Central European	Paris, France
2	EET: Eastern European	Athens, Greece
3	BT: Baghdad	Moscow, Russia
4	---	Abu Dhabi, UAE
5	---	Tashkent
6	---	Astana
7	---	Bangkok
8	CCT: China Coast	Beijing
9	JST: Japan Standard	Tokyo
10	GST: Guam Standard	Sydney
11	---	Magadan
12	IDLE: International Date Line East NZST: New Zealand Standard	Wellington, New Zealand

Figure 11





4.1.5 Temperature Units of Measure





To change the temperature units of measure, scroll  to the Temperature Units field, and press the  key to toggle between °F and °C.

4.1.6 Sensor Labeling

You can label the location of each of your sensors from a pre-programmed menu



Icon	Description
	Scroll right key Press this key to scroll down/right.
	Selection key Press this key to select and enter the option.
	Scroll left key Press this key to scroll up/left.
	Mode key Press this key to enter to next mode.

To add a label, Press the Mode Key  to the Channel Reference Screen. Highlight 'Setup' for the Channel you wish to add a label to. Press the  Selection key to access the Channel Reference screen. Use the  Scroll keys to highlight the label you wish to use. Press the  Selection key to save the selected Channel Reference. Press the  Mode key till you return to the Home screen to view the newly added label.

4.2 Calibration

To enter the calibration mode, press the **MENU** key twice.

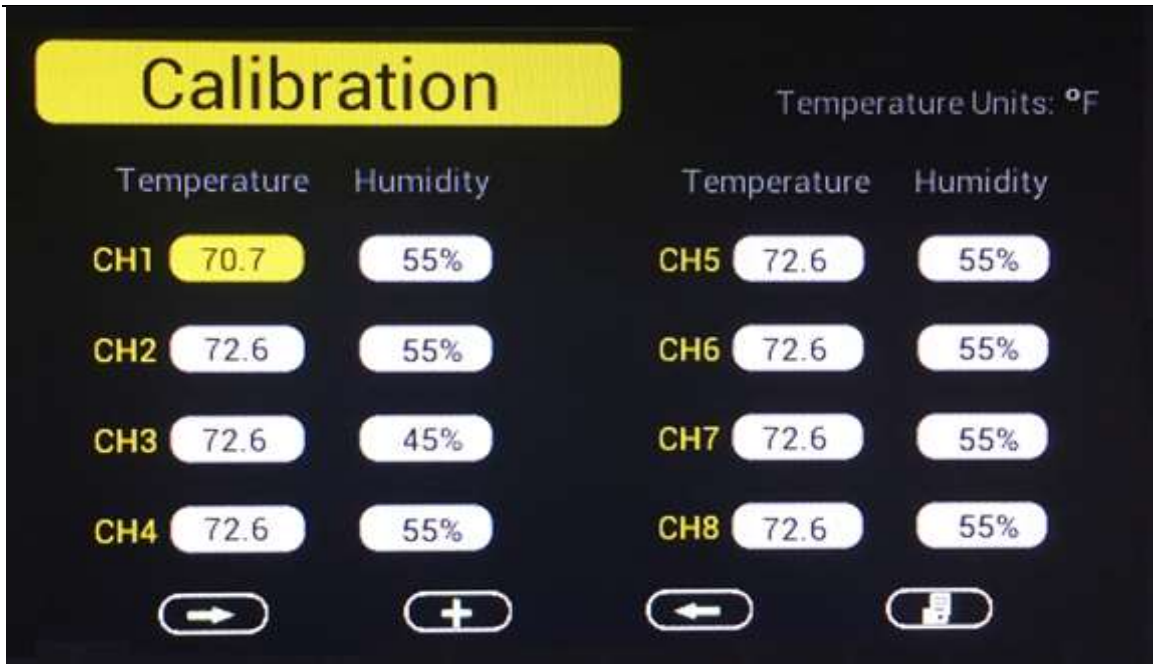

Figure 12











Icon	Description
	Scroll down/right key Press this key to scroll down/right.
	Selection/value increase key Press this key to select parameter and enter the calibration interface. Increase the value during calibration.
	Value Decrease key Decrease the value during calibration.
	Scroll up/left key Press this key to scroll up/left.
	Mode key Press this key to enter to next mode
	Return Key Back to main menu of calibration mode.
	Resume Key Cancel the calibration and resume.

Figure 13

Scroll  to the temperature or humidity field you wish to calibrate, press the  key to perform the calibration, and press the  or  key to match your calibration source.

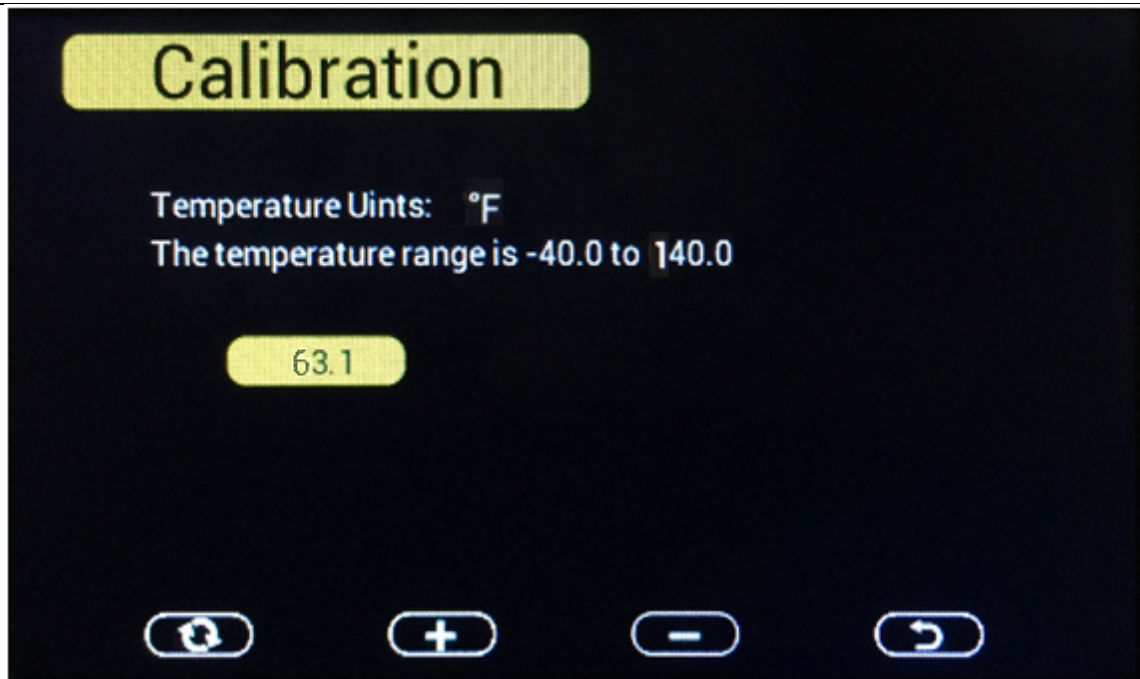



Figure 14

4.2.1 Notes about Calibration

 **Note:** The calibrated value can only be adjusted on the console. The remote sensor(s) always displays the un-calibrated or measured value.

 **Note:** The measured humidity range is between 10 and 99%. Humidity cannot be accurately measured outside of this range. Thus, the humidity cannot be calibrated below 10% or above 99%.

The purpose of calibration is to fine tune or correct for any sensor error associated with the devices margin of error. The measurement can be adjusted from the console to calibrate to a known source.

Calibration is only useful if you have a known calibrated source you can compare it against, and is optional. This section discusses practices, procedures and sources for sensor calibration to reduce manufacturing and degradation errors. Do not compare your readings obtained from sources such as the internet, radio, television or newspapers. They are in a different location and typically update once per hour.

The purpose of your weather station is to measure conditions of your surroundings, which vary significantly from location to location.

4.2.2 Humidity Calibration Methods

Official stations recalibrate or replace humidity sensors on a yearly basis. Due to manufacturing tolerances, the humidity is accurate to $\pm 5\%$. To improve this accuracy, the indoor and outdoor humidity can be calibrated using an accurate source, such as a sling psychrometer or one step humidpak calibration kits available at AmbientWeather.com.

4.2.3 Temperature Calibration Methods

Temperature errors can occur when a sensor is placed too close to a heat source (such as a building structure, the ground or trees).

To calibrate temperature, we recommend a mercury or red spirit (fluid) thermometer. Bi-metal (dial) and other digital thermometers are not a good source and have their own margin of error. Using a local weather station in your area is also a poor source due to changes in location, timing (airport weather stations are only updated once per hour) and possible calibration errors (many official weather stations are not properly installed and calibrated).



Place the sensor in a shaded, controlled environment next to the fluid thermometer, and allow the sensor to stabilize for 48 hours. Compare this temperature to the fluid thermometer and adjust the console to match the fluid thermometer.

4.3 Min / Max and Alarm Mode

In the Normal mode, press the **MENU** key three times to enter Min / Max and Alarm Mode.

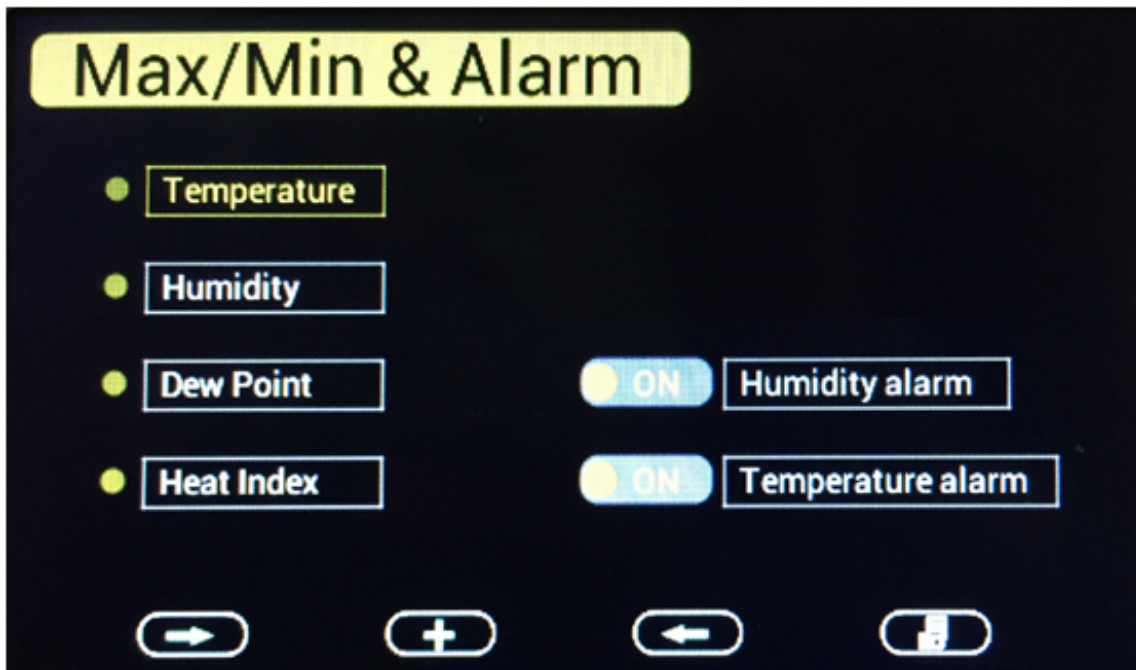
4.3.1 Min / Max



Icon	Description
	Scroll down/right key Press this key to scroll down/right.
	Selection/value increase key Press this key to select parameter to check according max/min records. Switch on/off alarms and increase the value during alarm setup.







	Value Decrease key Decrease the value during alarm setup.
	Scroll up/left key Press this key to scroll up/left.
	Mode key Press this key to enter to next mode
	Return Key Back to main menu of calibration mode.
	Resume Key Cancel the calibration and resume.

Figure 15

Scroll  to the temperature, humidity, dew point or heat index min/max field you wish to view, and press the  key. Note that dashes (---) will be displayed for sensors that are not programmed for your system.

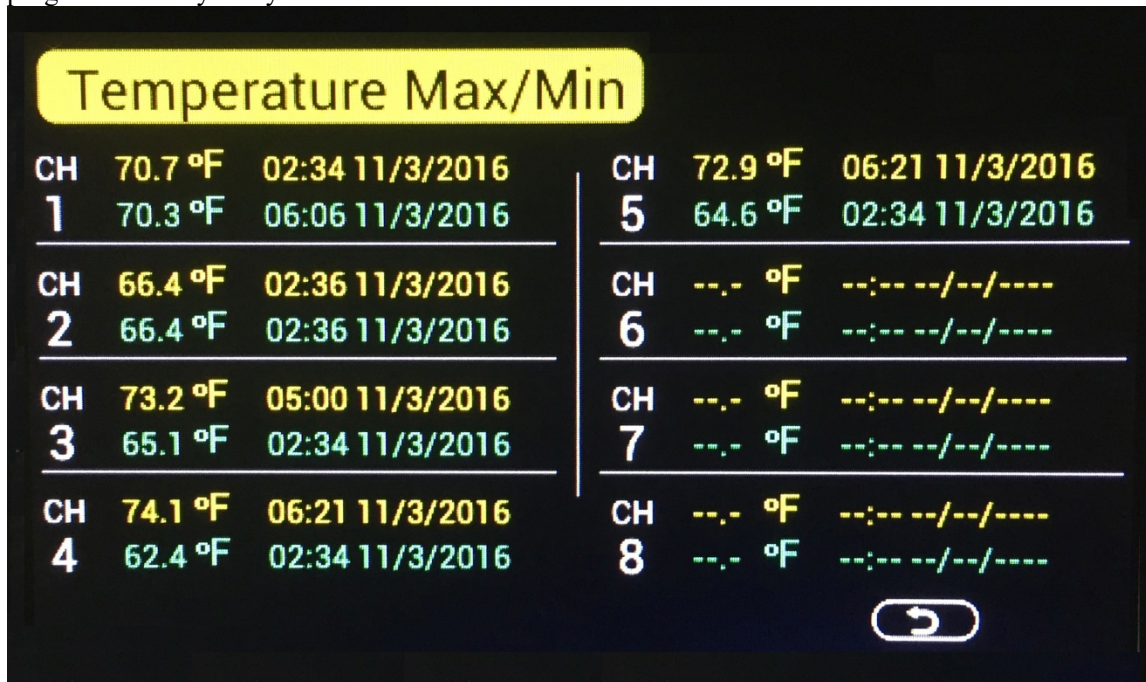





Figure 16

To clear all of the min and max values, refer to Section 4.4.2 for details.

4.3.2 Alarms

You can set a high and low temperature and humidity alarm on **Channels 1-8**.

If the measured value is greater than the high alarm, an audible alert will sound and the alarm icon  will flash on the alarm panel, and the alarm icon  will appear on the main panel.

If the measured value is less than the high alarm, an audible alert will sound and the alarm icon  will flash on the alarm panel, and the alarm icon  will appear on the main panel.

When an alarm has been triggered, the alarm will sound for 120 second and the corresponding alarm icon will flash until the alarm condition is no longer met. Press any key to silence the alarm.

The alarm icon is color coded, and will flash as shown in Figure 17 if one or more alarms are triggered.









Alarm Type	 Color
High Alarm	Red – grey - red
Low alarm	Blue – grey - blue
High alarm & Low alarm both activated	Red – grey – blue – grey – red
Beep alarm stop	grey

Figure 17

Scroll  to the Humidity or Temperature Alarm On/Off switch, and press the  key to toggle the Humidity or Temperature Alarm On or Off.

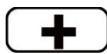

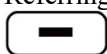













Scroll  to the Humidity Alarm or Temperature Alarm field, and press the  key to display the alarm programming panel, as shown in Figure 18.





 **Note:** The alarm must be turned On to program the alarm settings.

Referring to Figure 18, scroll  to the channel and alarm limit, and press the  or  key to adjust the alarm limit up or down. Scroll to the alarm field and press the  key to turn the alarm bell on our off to activate the alarm.

Humidity Alarm

Humidity Units: %



	High Alarm	Low Alarm		High Alarm	Low Alarm
CH1	59% 	20% 	CH5	90% 	20% 
CH2	90% 	20% 	CH6	90% 	20% 
CH3	90% 	20% 	CH7	90% 	20% 
CH4	90% 	20% 	CH8	90% 	20% 

Humidity

The humidity range is 10% to 99%

90%







Icon	Description
	Scroll down/right key Press this key to scroll down/right.
	Selection/value increase key Press this key to select parameter to set alarm thresholds and turn on the alarm icon. Red alarm icon is high alarm. Blue one is low alarm.
	Value Decrease key Decrease the value during alarm setup.
	Scroll up/left key Press this key to scroll up/left.
	Mode key Press this key to back to main menu or enter to next mode
	Return Key Back to main menu of alarm menu.

Figure 18

4.4 Factory Settings

To enter the Factory mode, press the **MENU** key four times.

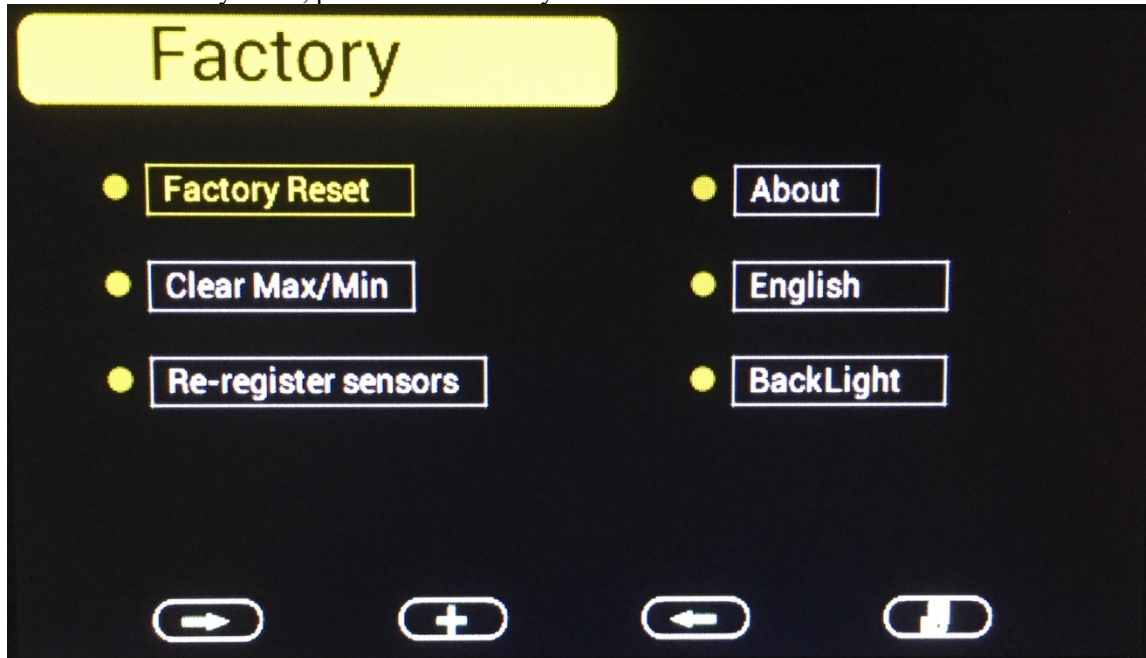



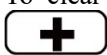

Figure 19

4.4.1 Factory Reset

To restore to factory default, scroll  to the Factory Reset field and press  to clear all settings and restore to factory default.

4.4.2 Clear Max/Min Values

To clear all of the max and min values, scroll  to the Clear Max/Min field and press  to clear all of the stored max and min values.

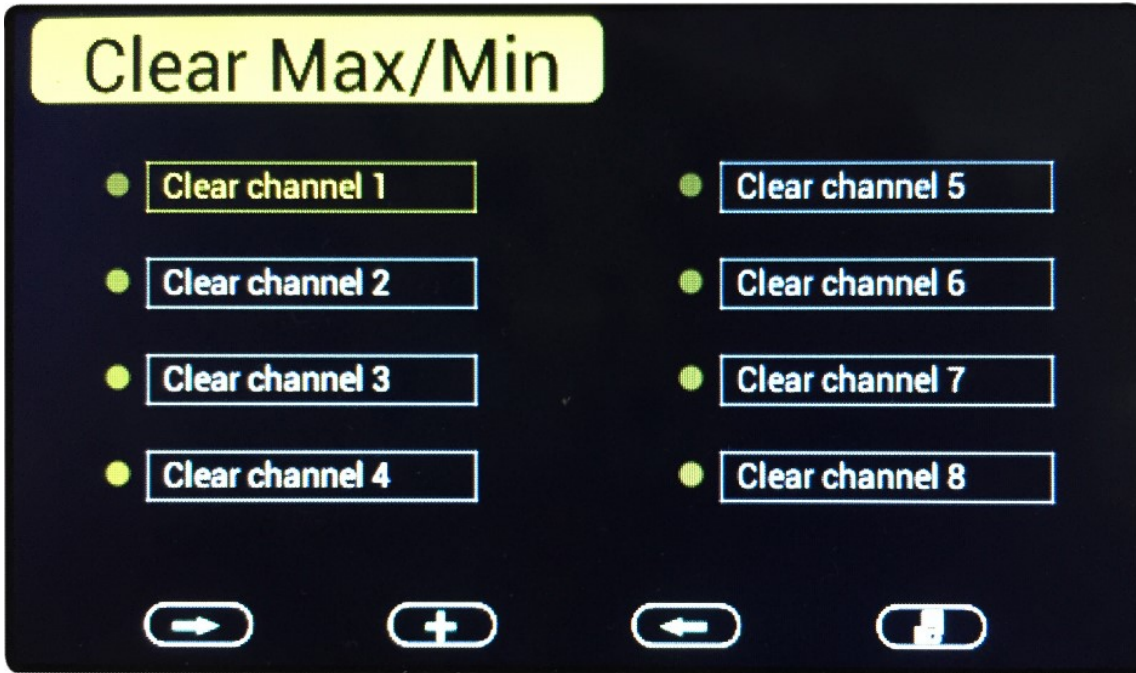



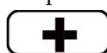

Figure 20

4.4.3 Re-register Sensors

If sensor communication is lost with a specific sensor, you can re-acquire.

Scroll  to the re-register sensors field, and press  to view the re-register panel.

Scroll the sensor you wish to register, and press  to re-acquire this sensor. Press the  button to highlight Yes and press  to confirm.

4.4.4 About

Scroll  to the About field, and press  to view to view the hardware and firmware version.

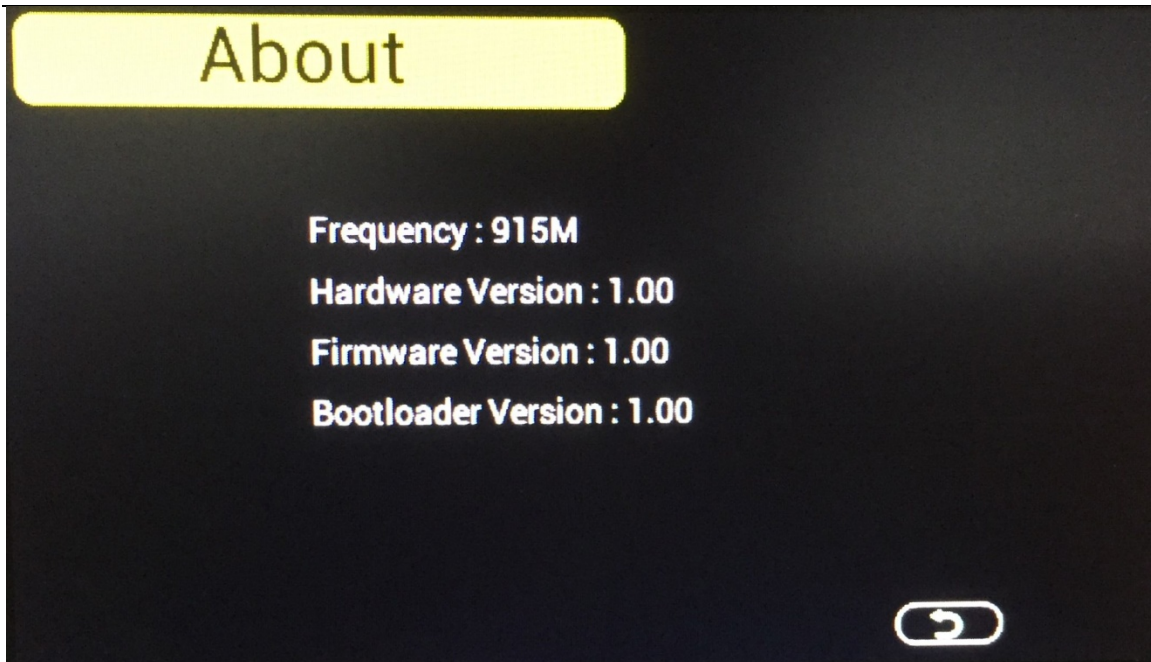





Figure 21



4.4.5 Language

Scroll  to the Language field, and press  to change the language (currently only English is only supported).

4.4.6 Back Light

Scroll  to the BackLight field, and press  to adjust the backlight features.

To turn on and off the back lit display at certain times during the day, scroll  to the Backlight control field, and select the  key to check the Backlight Control switch.

Scroll  to adjust the backlight on and off time. Press the  or  keys to adjust the hours and minutes up or down.

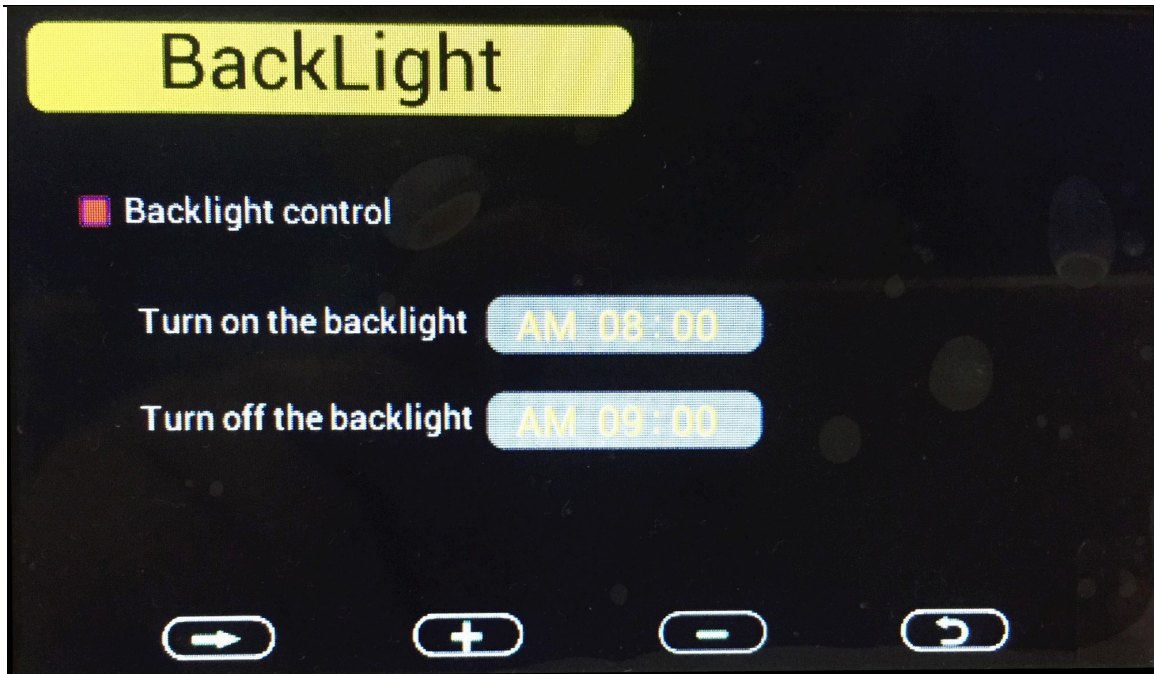

Figure 22

5 Other Features

5.1 Radio Controlled Clock (RCC)

After the remote sensor is powered up, the sensor will transmit weather data for 30 seconds, and then the sensor will begin radio controlled clock (RCC) reception. During the RCC time reception period (maximum 5 minutes), no weather data will be transmitted to avoid interference.

If the signal reception is not successful within 3 minute, the signal search will be cancelled and will automatically resume every two hours until the signal is successfully captured. The regular RF link will resume once RCC reception routine is finished. In some locations, RCC reception may take a couple of days to receive the signal.

Once the radio controlled time is received, the RCC reception icon  will turn on next to the date and time field.

5.2 SD Card Export and Firmware Updates

With the use of an optional Micro SD Card (available from Ambient Weather), you can export data to a computer, save historical graphs (in the event of a power failure) and update firmware when new versions are released.



Figure 23

5.2.1 Datalogging and SD Card Data Export Function

The console includes a micro SD / TF card slot on the right side, as shown in Figure 4.

Backup data to micro SD / TF card (see the Accessories section of this manual for more information on micro SD / TF cards).

The SD card will record data into the HISTORY directory.

The file is comma separated value (csv) and can be imported into Microsoft Excel, or other text based applications.

The file format is as follows:

YYYYCH#A

where YYYY is the year, # is the channel number and A is the revision letter.

Example: 2016CH2A is the data for 2016, Channel 2, and A is the revision letter each time you change a units of measure or calibration setting.

Below is an example of the file output:

```
Time,Temperature(F),Humidity(%),Dewpoint(F),HeatIndex(F)
2016/02/18 08:05,48.7,32,20.3,48.7
2016/02/18 08:10,49.1,33,21.2,49.1
2016/02/18 08:15,49.1,31,19.8,49.1
```

5.2.2 Firmware Updates

Firmware updates and instructions are available at the following link:

<https://help.ambientweather.net/help/ambient-weather-ws-3000-download-center/>

5.3 PC Software

Optional PC Software is available for download.

The software features:

- Live Data Display
- Program Date and Time
- Program Custom Display
- Set Alarms
- Calibrate Temperature and Humidity
- Export and Graph Data from the SD Card
- Sync Date and Time from the Computer

5.3.1 Getting Started

1. Connect the console to the PC with the USB cable (included)
2. Download the software here:

<https://help.ambientweather.net/help/ambient-weather-ws-3000-download-center/>

Run the installer. Make a note of where you installed the software:

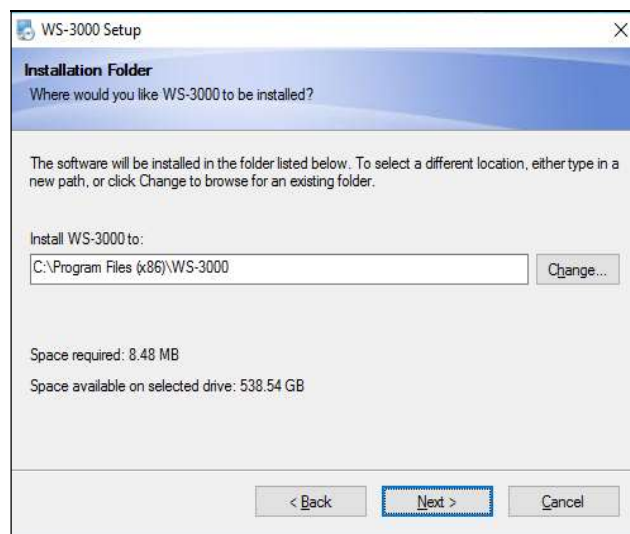

Figure 24

3. Run the program. Reference Figure 25. The main display screen will display “Connected” if properly communicating through the USB port.

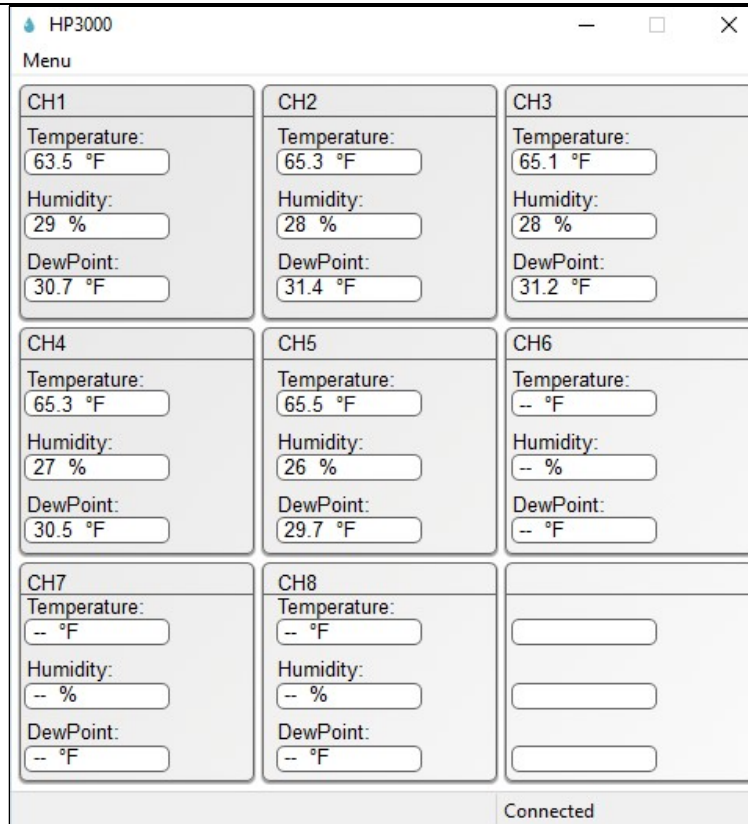

Figure 25

5.3.2 Time, Date and Display Setup

Select **Menu** | **Setup** to set the time, date and display customization settings.

From this screen you can set the graph type on the weather station screen (temperature, humidity, dew point or heat index), graph hours, time zone and daylight savings settings, time and date format, temperature units of measure, archive interval, and display preferences (temperature, humidity, dew point or heat index).

For details, reference Figure 26.

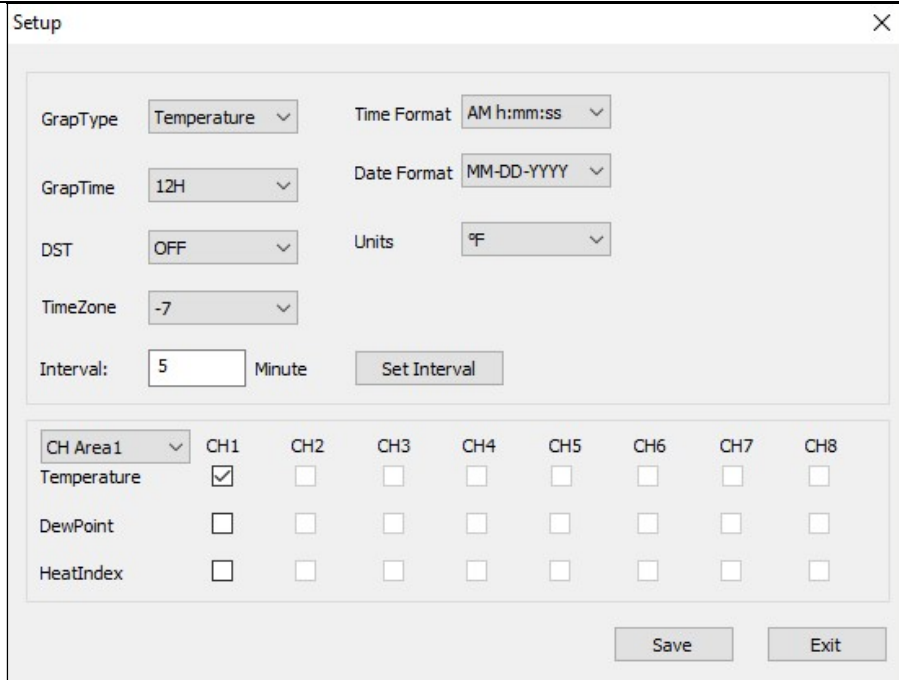

Setup

GrapType: Time Format:
 GrapTime: Date Format:
 DST: Units:
 TimeZone:
 Interval: Minute

CH Area1	CH1	CH2	CH3	CH4	CH5	CH6	CH7	CH8
Temperature	<input checked="" type="checkbox"/>	<input type="checkbox"/>	<input type="checkbox"/>	<input type="checkbox"/>	<input type="checkbox"/>	<input type="checkbox"/>	<input type="checkbox"/>	<input type="checkbox"/>
DewPoint	<input type="checkbox"/>	<input type="checkbox"/>	<input type="checkbox"/>	<input type="checkbox"/>	<input type="checkbox"/>	<input type="checkbox"/>	<input type="checkbox"/>	<input type="checkbox"/>
HeatIndex	<input type="checkbox"/>	<input type="checkbox"/>	<input type="checkbox"/>	<input type="checkbox"/>	<input type="checkbox"/>	<input type="checkbox"/>	<input type="checkbox"/>	<input type="checkbox"/>

Figure 26

For more information on time, date and display settings, please reference Section 4.1.

5.3.3 Alarm Settings

Select **Menu | Alarm** to set the high and low temperature and humidity alarms for each of the 8 supported channels.

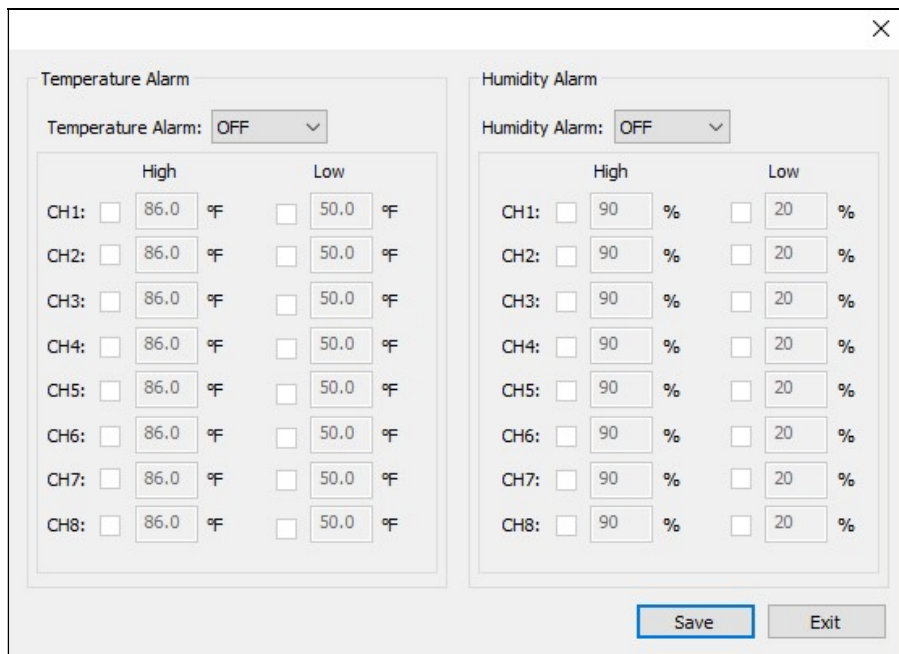

Temperature Alarm

Temperature Alarm:

	High	Low
CH1:	<input type="checkbox"/> 86.0 °F	<input type="checkbox"/> 50.0 °F
CH2:	<input type="checkbox"/> 86.0 °F	<input type="checkbox"/> 50.0 °F
CH3:	<input type="checkbox"/> 86.0 °F	<input type="checkbox"/> 50.0 °F
CH4:	<input type="checkbox"/> 86.0 °F	<input type="checkbox"/> 50.0 °F
CH5:	<input type="checkbox"/> 86.0 °F	<input type="checkbox"/> 50.0 °F
CH6:	<input type="checkbox"/> 86.0 °F	<input type="checkbox"/> 50.0 °F
CH7:	<input type="checkbox"/> 86.0 °F	<input type="checkbox"/> 50.0 °F
CH8:	<input type="checkbox"/> 86.0 °F	<input type="checkbox"/> 50.0 °F

Humidity Alarm

Humidity Alarm:

	High	Low
CH1:	<input type="checkbox"/> 90 %	<input type="checkbox"/> 20 %
CH2:	<input type="checkbox"/> 90 %	<input type="checkbox"/> 20 %
CH3:	<input type="checkbox"/> 90 %	<input type="checkbox"/> 20 %
CH4:	<input type="checkbox"/> 90 %	<input type="checkbox"/> 20 %
CH5:	<input type="checkbox"/> 90 %	<input type="checkbox"/> 20 %
CH6:	<input type="checkbox"/> 90 %	<input type="checkbox"/> 20 %
CH7:	<input type="checkbox"/> 90 %	<input type="checkbox"/> 20 %
CH8:	<input type="checkbox"/> 90 %	<input type="checkbox"/> 20 %

Figure 27

For more information on Alarm Settings, please reference Section 4.3.

5.3.4 Calibration

Select **Menu | Calibration** to calibrate each of the 8 supported channels.

The temperature and humidity values are offsets.

Example: If the actual temperature measured by a calibrated source is 70 °F, and the channel 1 temperature sensor reads 69.5 °F:

CH1 Temperature Offset = $70 - 69.5 = 0.5$ °F.

Enter 0.5 in the CH1 Temperature field, as shown in Figure 28.

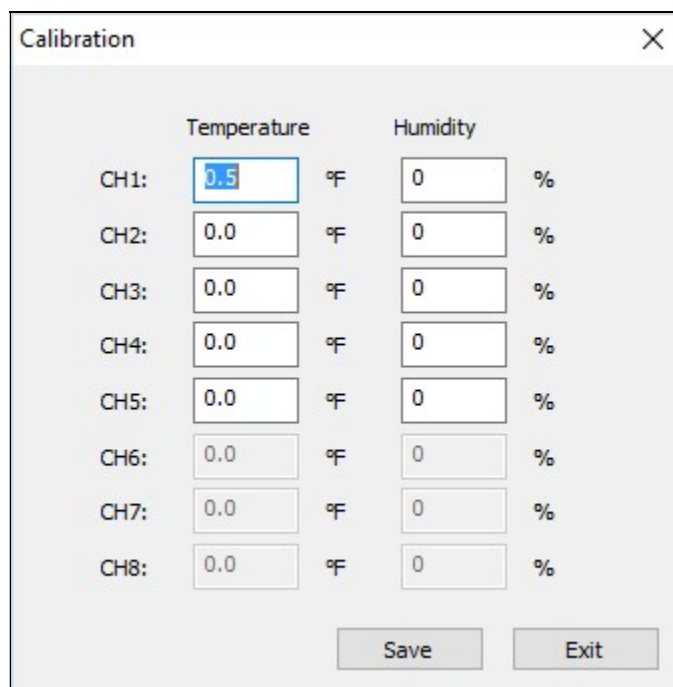

	Temperature		Humidity	
CH1:	<input type="text" value="0.5"/>	°F	<input type="text" value="0"/>	%
CH2:	<input type="text" value="0.0"/>	°F	<input type="text" value="0"/>	%
CH3:	<input type="text" value="0.0"/>	°F	<input type="text" value="0"/>	%
CH4:	<input type="text" value="0.0"/>	°F	<input type="text" value="0"/>	%
CH5:	<input type="text" value="0.0"/>	°F	<input type="text" value="0"/>	%
CH6:	<input type="text" value="0.0"/>	°F	<input type="text" value="0"/>	%
CH7:	<input type="text" value="0.0"/>	°F	<input type="text" value="0"/>	%
CH8:	<input type="text" value="0.0"/>	°F	<input type="text" value="0"/>	%

Save Exit

Figure 28

It may take a minute or two for the console to update the calibrated temperature, since the temperature updates once per minute.

 **Note:** There may be some °F to °C rounding error, since the native calculations are performed in °C. For example, if you enter 0.6 °F in the field, 0.5 °F may be displayed the next time you open this panel.

For more information on Calibration, please reference Section 4.2.

5.3.5 SDCard File

 **Note:** The Micro SD Card is optional, not included and sold separately.

Select **Menu** | **SDCard File** to download and analyze data stored on the SD Card.

Select the file you wish to view from the list and press **Select** to view the data.

To graph the data:

1. Identify the data file start and end date and times (Figure 29).
2. Press the **Graph** button.
3. Enter the start and end date and times in the appropriate fields identified in Step 1 (Figure 30).
4. Select the parameter you wish to graph, and press the **Select** button.

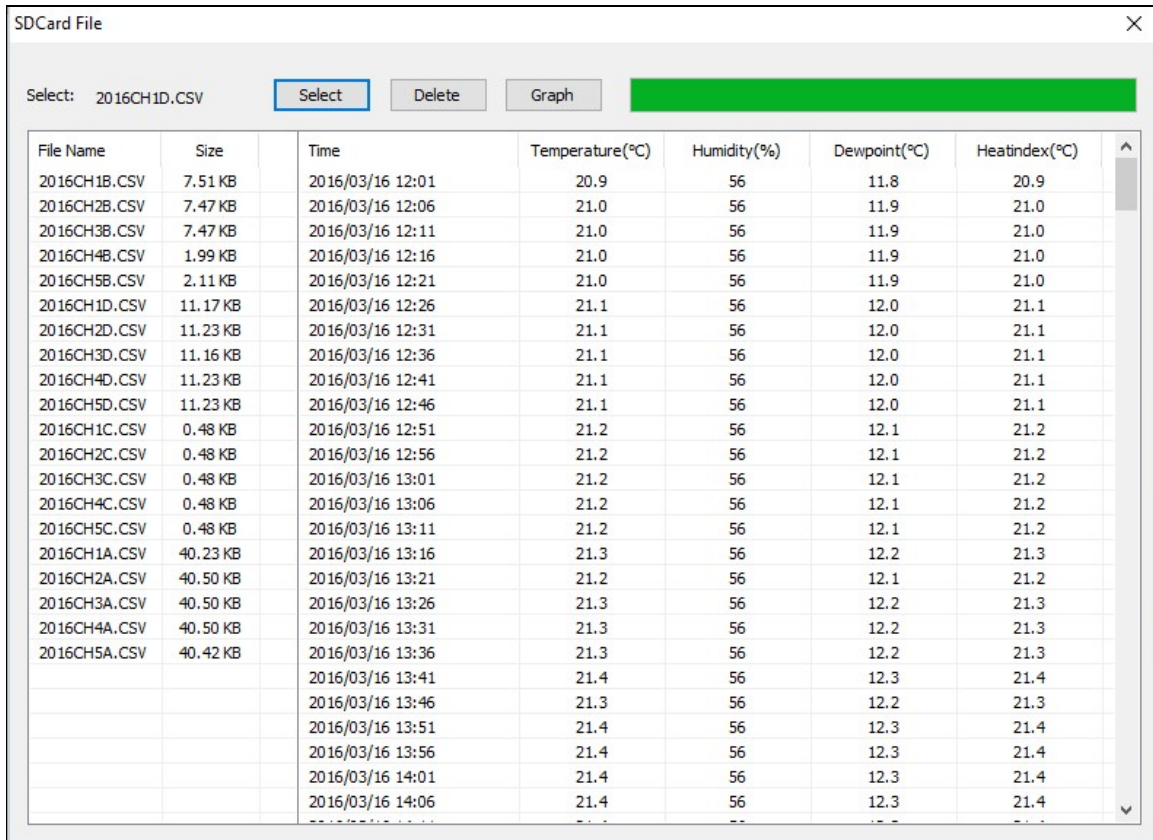

The screenshot shows a window titled "SDCard File" with a search bar containing "2016CH1D.CSV" and buttons for "Select", "Delete", and "Graph". Below the buttons is a table with the following columns: File Name, Size, Time, Temperature(°C), Humidity(%), Dewpoint(°C), and Heatindex(°C). The table contains 25 rows of data, with the last row being partially obscured by a scroll bar.

File Name	Size	Time	Temperature(°C)	Humidity(%)	Dewpoint(°C)	Heatindex(°C)
2016CH1B.CSV	7.51 KB	2016/03/16 12:01	20.9	56	11.8	20.9
2016CH2B.CSV	7.47 KB	2016/03/16 12:06	21.0	56	11.9	21.0
2016CH3B.CSV	7.47 KB	2016/03/16 12:11	21.0	56	11.9	21.0
2016CH4B.CSV	1.99 KB	2016/03/16 12:16	21.0	56	11.9	21.0
2016CH5B.CSV	2.11 KB	2016/03/16 12:21	21.0	56	11.9	21.0
2016CH1D.CSV	11.17 KB	2016/03/16 12:26	21.1	56	12.0	21.1
2016CH2D.CSV	11.23 KB	2016/03/16 12:31	21.1	56	12.0	21.1
2016CH3D.CSV	11.16 KB	2016/03/16 12:36	21.1	56	12.0	21.1
2016CH4D.CSV	11.23 KB	2016/03/16 12:41	21.1	56	12.0	21.1
2016CH5D.CSV	11.23 KB	2016/03/16 12:46	21.1	56	12.0	21.1
2016CH1C.CSV	0.48 KB	2016/03/16 12:51	21.2	56	12.1	21.2
2016CH2C.CSV	0.48 KB	2016/03/16 12:56	21.2	56	12.1	21.2
2016CH3C.CSV	0.48 KB	2016/03/16 13:01	21.2	56	12.1	21.2
2016CH4C.CSV	0.48 KB	2016/03/16 13:06	21.2	56	12.1	21.2
2016CH5C.CSV	0.48 KB	2016/03/16 13:11	21.2	56	12.1	21.2
2016CH1A.CSV	40.23 KB	2016/03/16 13:16	21.3	56	12.2	21.3
2016CH2A.CSV	40.50 KB	2016/03/16 13:21	21.2	56	12.1	21.2
2016CH3A.CSV	40.50 KB	2016/03/16 13:26	21.3	56	12.2	21.3
2016CH4A.CSV	40.50 KB	2016/03/16 13:31	21.3	56	12.2	21.3
2016CH5A.CSV	40.42 KB	2016/03/16 13:36	21.3	56	12.2	21.3
		2016/03/16 13:41	21.4	56	12.3	21.4
		2016/03/16 13:46	21.3	56	12.2	21.3
		2016/03/16 13:51	21.4	56	12.3	21.4
		2016/03/16 13:56	21.4	56	12.3	21.4
		2016/03/16 14:01	21.4	56	12.3	21.4
		2016/03/16 14:06	21.4	56	12.3	21.4

Figure 29

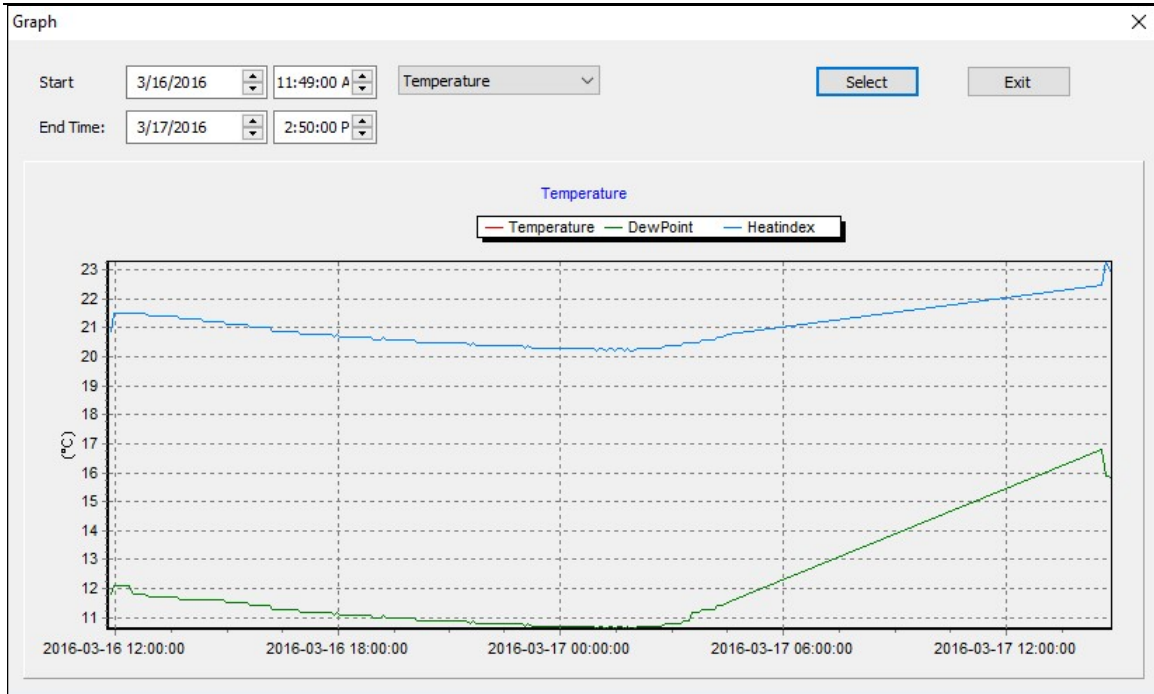



Figure 30

For more information on SD Card file formats, please reference Section 5.2.

6 Best Practices for Wireless Communication

 **Note:** To insure proper communication, mount the remote sensor on a vertical surface, such as a wall. **Do not lie the sensor flat.**

Wireless communication is susceptible to interference, distance, walls and metal barriers. We recommend the following best practices for trouble free wireless communication.

1. **Electro-Magnetic Interference (EMI).** Keep the console several feet away from computer monitors and TVs.
2. **Radio Frequency Interference (RFI).** If you have other 915 MHz devices and communication is intermittent, try turning off these other devices for troubleshooting purposes. You may need to relocate the transmitters or receivers to avoid intermittent communication.
3. **Line of Sight Rating.** This device is rated at 300 feet line of sight (no interference, barriers or walls) but typically you will get 100 feet maximum under most real-world installations, which include passing through barriers or walls.
4. **Metal Barriers.** Radio frequency will not pass through metal barriers such as aluminum siding. If you have metal siding, align the remote and console through a window to get a clear line of sight.

The following is a table of reception loss vs. the transmission medium. Each “wall” or obstruction decreases the transmission range by the factor shown below.

Medium	RF Signal Strength Reduction
Glass (untreated)	5-15%
Plastics	10-15%
Wood	10-40%

Medium	RF Signal Strength Reduction
Brick	10-40%
Concrete	40-80%
Metal	90-100%

7 Glossary of Terms

Term	Definition
Accuracy	Accuracy is defined as the ability of a measurement to match the actual value of the quantity being measured.
Hygrometer	A hygrometer is a device that measures relative humidity. Relative humidity is a term used to describe the amount or percentage of water vapor that exists in air.
Range	Range is defined as the amount or extent a value can be measured.

8 Accessories

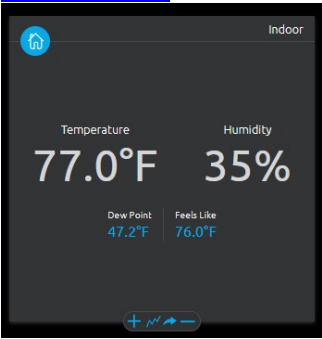
Accessory	Description
microSDHC Class 4 Flash Memory Card SDC4/8GB	MicroSDHC for data backup and advanced data analysis.
OBSERVERIP 	<p>OBSERVERIP - Send real time data to AmbientWeather.net. The Ambient Weather Network is the most user-friendly design for monitoring your data across different platforms.</p> <p>Quickly view detailed information with our animated expandable modules. Monitor indoor and outdoor conditions, including wind speed, wind direction, rainfall, UV, solar radiation, barometric pressure, indoor temperature, indoor humidity, dew point, heat index, wind chill and more.</p> <p>Includes dials, gauges, graphs and text reports for every parameter. Download the data to your computer for further data analysis.</p>

9 Specifications

9.1 Wireless Specifications

- Line of sight wireless transmission (in open air): 300 feet, 100 feet under most conditions.
- Frequency: 915 MHz
- Update Rate: About 60 seconds

9.2 Measurement Specifications

The following table provides specifications for the measured parameters.



Measurement	Range	Accuracy	Resolution
Indoor Temperature	32 to 140 °F	± 2 °F	0.1 °F
Outdoor Temperature	-40 to 140 °F	± 2 °F	0.1 °F
Indoor Humidity	10 to 99 %	± 5% (only guaranteed between 20 to 90%)	1 %
Outdoor Humidity	10 to 99%	± 5% (only guaranteed between 20 to 90%)	1 %

9.3 Power Consumption

- Base station (display console) : AC Power
- Remote sensor : 2 x AA 1.5V Alkaline or Lithium batteries (not included)
- Battery life: Minimum 12 months for base station with one sensor and excellent reception. Intermittent reception and multiple sensors may reduce the battery life.
Minimum 12 months for thermometer-hygrometer sensor (use lithium batteries in cold weather climates less than -4 °F)

10 Optional Sensors

The WS-3000 supports the following optional sensors:

Item Number	Number of Channels	Description	Image
WH31E	8*	Thermo-Hygrometer Sensor	
WH31P	8*	Probed Thermometer	
WH31PF	8*	Wireless Waterproof Floating Pool and Spa Thermometer	

(*) The WH31E, WH31P and WH31PF share the same 8-channels.

11 Troubleshooting Guide

If your question is not answered here, you can contact us as follows:

1. Email Support: support@ambientweather.com
2. Technical Support: 480-346-3380 (M-F 8am to 3pm Arizona Time)

Problem	Solution
<p>Wireless remote (thermo-hygrometer) not reporting in to console.</p> <p>There are dashes (---) on the display console, and these sensors are a part of your system.</p>	<p>If any of the sensor communication is lost, dashes (---) will be displayed on the screen. To reacquire the signal, re-acquire the signal per Section 4.4.3. Please verify each sensor is on a different channel by viewing the sensor's LCD display.</p> <p>The maximum line of sight communication range is 300' and 100' under most conditions. Move the sensor assembly closer to the display console.</p> <p>If the sensor assembly is too close (less than 5'), move the sensor assembly away from the display console.</p> <p>Make sure the remote sensor LCD display is working.</p> <p>Install a fresh set of batteries in the remote thermo-hygrometer. For cold weather environments, install lithium batteries.</p> <p>Make sure the remote sensors are not transmitting through solid metal (acts as an RF shield), or earth barrier (down a hill).</p> <p>Move the display console around electrical noise generating devices, such as computers, TVs and other wireless transmitters or receivers.</p> <p>Move the remote sensor to a higher location. Move the remote sensor to a closer location.</p>
<p>Temperature sensor reads too high in the day time.</p>	<p>Make sure the thermo-hygrometer is mounted in a shaded area on the north facing wall. Consider the following radiation shield if this is not possible: http://www.ambientweather.com/amwespatean.html</p>
<p>Temperature sensors do not agree</p>	<p>Allow up to one hour for the sensors to stabilize due to signal filtering. The sensors should agree within 4 °F (the sensor accuracy is ± 2 °F) under worst case conditions.</p> <p>Use the calibration feature to match the indoor and outdoor temperature to a known source.</p>
<p>Humidity sensors do not agree</p>	<p>Allow up to one hour for the sensors to stabilize due to signal filtering. The indoor and outdoor humidity sensors should agree within 10 % (the sensor accuracy is ± 5 %) under worst case conditions.</p> <p>Use the calibration feature to match the indoor and</p>

Problem	Solution
	outdoor humidity to a known source.
Display console contrast is weak	Check the backlight display settings referenced in Section Back Light.

12 Liability Disclaimer

Please help in the preservation of the environment and return used batteries to an authorized depot. The electrical and electronic wastes contain hazardous substances. Disposal of electronic waste in wild country and/or in unauthorized grounds strongly damages the environment.

Reading the “User manual” is highly recommended. The manufacturer and supplier cannot accept any responsibility for any incorrect readings and any consequences that occur should an inaccurate reading take place.

This product is designed for use in the home only as indication of weather conditions. This product is not to be used for medical purposes or for public information.

The specifications of this product may change without prior notice.

This product is not a toy. Keep out of the reach of children.

No part of this manual may be reproduced without written authorization of the manufacturer.

Ambient, LLC WILL NOT ASSUME LIABILITY FOR INCIDENTAL, CONSEQUENTIAL, PUNITIVE, OR OTHER SIMILAR DAMAGES ASSOCIATED WITH THE OPERATION OR MALFUNCTION OF THIS PRODUCT.

13 FCC Statement

Statement according to FCC part 15.19:

This device complies with part 15 of the FCC rules. Operation is subject to the following two conditions:

1. This device may not cause harmful interference.
2. This device must accept any interference received, including interference that may cause undesired operation.

Statement according to FCC part 15.21:

Modifications not expressly approved by this company could void the user's authority to operate the equipment.

Statement according to FCC part 15.105:

NOTE: This equipment has been tested and found to comply with the limits for a Class B digital device, pursuant to Part 15 of the FCC Rules. These limits are designed to provide reasonable protection against harmful interference in a residential installation. This equipment generates, uses and can radiate radio frequency energy and, if not installed and used in accordance with the instructions, may cause harmful interference to radio communications.

However, there is no guarantee that interference will not occur in a particular installation. If this equipment does cause harmful interference to radio or television reception, which can be determined by turning the equipment off and on, the user is encouraged to try to correct the interference by one or more of the following measures:

- Reorient or relocate the receiving antenna.
- Increase the separation between the equipment and receiver.

- Connect the equipment into an outlet on a circuit different from that to which the receiver is connected.
- Consult the dealer or an experienced radio/TV technician for help.

14 Warranty Information

Ambient, LLC provides a 1-year limited warranty on this product against manufacturing defects in materials and workmanship.

This limited warranty begins on the original date of purchase, is valid only on products purchased and only to the original purchaser of this product. To receive warranty service, the purchaser must contact Ambient, LLC for problem determination and service procedures.

Warranty service can only be performed by a Ambient, LLC. The original dated bill of sale must be presented upon request as proof of purchase to Ambient, LLC.

Your Ambient, LLC warranty covers all defects in material and workmanship with the following specified exceptions: (1) damage caused by accident, unreasonable use or neglect (lack of reasonable and necessary maintenance); (2) damage resulting from failure to follow instructions contained in your owner's manual; (3) damage resulting from the performance of repairs or alterations by someone other than an authorized Ambient, LLC authorized service center; (4) units used for other than home use (5) applications and uses that this product was not intended (6) the products inability to receive a signal due to any source of interference or metal obstructions and (7) extreme acts of nature, such as lightning strikes or floods.

This warranty covers only actual defects within the product itself, and does not cover the cost of installation or removal from a fixed installation, normal set-up or adjustments, claims based on misrepresentation by the seller or performance variations resulting from installation-related circumstances.

15 California Prop 65

WARNING: Use of the Ambient Weather Products can expose you to chemicals, including lead and lead compounds, which are known to the State of California to cause cancer and bisphenol A (BPA), and phthalates DINP and/or DEHP, which are known to the State of California to cause birth defects or other reproductive harm.

Can I Trust that Ambient Weather Products are Safe Despite this Warning?

In 1986, California voters approved the Safe Drinking Water and Toxic Enforcement Act known as Proposition 65 or Prop 65. The purpose of Proposition 65 is to ensure that people are informed about exposure to chemicals known by the State of California to cause cancer, birth defects and/or other reproductive harm. A company with ten or more employees that operates within the State of California (or sells products in California) must comply with the requirements of Proposition 65. To comply, businesses are: (1) prohibited from knowingly discharging listed chemicals into sources of drinking water; and (2) required to provide a "clear and reasonable" warning before knowingly and intentionally exposing anyone to a listed chemical. Proposition 65 mandates that the Governor of California maintain and publish a list of chemicals that are known to cause cancer, birth defects and/or other reproductive harm. The [Prop 65 list](#), which must be updated annually, includes over 1,000 chemicals, including many that are commonly used in the electronics industry.

Although our manufacturing process is "lead-free" and RoHS compliant, it remains possible that trace amounts of lead could be found in components or subassemblies of Ambient Weather Products. Bisphenol A (BPSA) could conceivably be present in minute amounts in our plastic housings, lenses, labels or adhesives, and DEHP & DINP (phthalates) could possibly be found in PVC wire coatings of our cables, housings, and power cords. Unlike RoHS, Prop 65 does not establish a specific threshold for reporting on the substances of concern and instead sets forth a much less definitive standard requiring that the business demonstrate with certainty that there is "no significant risk" resulting from exposure. With respect to carcinogens, the "no significant risk" level is defined as the level which is calculated to result in not more than one excess case of cancer in 100,000 individuals exposed over a 70-year lifetime. In other words, if you are exposed to the chemical in question at this level every day for 70 years, theoretically, it will increase your chances of getting cancer by no more than 1 case in 100,000 individuals so exposed. With respect to reproductive toxicants, the "no significant risk" level is defined as the level of exposure which, even if multiplied by 1,000, will not produce birth defects or other reproductive harm. In other words, the level of exposure is below the "no observable effect level," divided by 1,000. (The "no observable effect level" is the highest dose level which has not been associated with observable reproductive harm in humans or test animals.) Proposition 65 does not clarify whether exposure is to be measured only in normal operation, or in the event of misuse such as intentionally damaging, incinerating or consuming an Ambient Weather Product or component and Ambient Weather has not attempted to evaluate the level of exposure.

A Proposition 65 warning means one of two things: (1) the business has evaluated the exposure and has concluded that it exceeds the "no significant risk level"; or (2) the business has chosen to provide a warning simply based on its knowledge about the presence of a listed chemical without attempting to evaluate the exposure. The California government has itself clarified that "The fact that a product bears a Proposition 65 warning does not mean by itself that the product is unsafe." The government has also explained, "You could think of Proposition 65 more as a 'right to know' law than a pure product safety law."

While using Ambient Weather Products as intended, we believe any potential exposure would be negligible or well within the "no significant risk" range. However, to ensure compliance with California law and our customers' right to know, we have elected to place the Proposition 65 warning signs on Ambient Weather Products.

For further information about California's Proposition 65, please visit <https://oehha.ca.gov/prop65/background/p65plain.html>

