Ambient Weather WS-7079 Wireless Wi-Fi Smart Weather Station User Manual



Table of Contents

1.	Introduction.....	3
2.	Warnings	3
3.	Getting Started	3
3.1	Parts List.....	3
3.2	Tools	3
3.3	Quick Start Guide.....	3
3.4	Product Features.....	5
3.4.1	Display	5
3.4.2	Sensor Array.....	6
3.5	Powering Up.....	6
3.5.1	Power Up Sequence	6
3.5.2	Initial Sensor Synchronization	8
3.5.3	Site Survey	8
3.5.4	Pole Mounting the Sensor Array	8
4.	Console Display	11
5.	Settings.....	12
5.1	Time Settings.....	12
5.1.1	Time Zone Settings	14
5.2	Month Day vs. Year Display	15
5.3	Moon Phase	15
5.4	Sunrise and Sunset	16
5.5	Wi-Fi Connection Status	16
5.6	Time Server Sync Status	16
5.7	Alarm Settings.....	17
5.7.1	Turning on and Off the Alarm Feature	17
5.7.2	Setting the Alarm Time	17
5.7.3	Using the Alarm and Snooze Functions	17
5.8	Temperature and Humidity Display and Settings.....	18
5.8.1	Temperature Units of Measure.....	18
5.8.2	Outdoor Sensor Array Signal Strength.....	18
5.8.3	Optional 7-Channel Sensors.....	18
5.8.4	Temperature and Humidity Trend	19
5.8.5	Temperature and Humidity Measurements Limits	19
5.9	Wind	19
5.9.1	Average Wind Speed, Wind Gust and Beaufort Scale.....	20
5.9.2	Wind Units of Measure and Wind Direction Format	21
5.9.3	Wind Speed Level Indicator.....	22
5.10	Barometric Pressure Display and Settings	22
5.10.1	Barometric Pressure Units of Measure	22
5.10.2	Absolute Pressure vs. Relative Pressure	22
5.10.3	Relative Pressure Calibration.....	22
5.11	The Forecast.....	23
5.12	Weather Index.....	23

5.13	Feels Like	23
5.13.1	UV Index, Light Intensity and Sunburn Time.....	24
5.13.2	Wind Chill.....	26
5.13.3	Heat Index.....	26
5.13.4	Dew Point.....	27
5.14	Rainfall.....	27
5.14.1	Rain Units of Measure	28
5.14.2	Rain Increments of Measure	28
5.14.3	Resetting Rain to Zero	28
5.15	Min / Max.....	28
5.16	History Data (Past 24 hours)	29
5.17	Alerts	29
5.17.1	Setting the Alerts.....	29
5.17.2	Activating an Alert.....	30
5.17.3	Silencing an Alert.....	31
5.17.4	Alert Duration	31
5.18	Backlight	31
6.	Connect your Console to Wi-Fi and the Internet.....	31
6.1	Register at Third Party Public Websites (optional):	31
6.2	Place Console in Access Point Mode	31
6.3	Connect to the Console's Wi-Fi Server	32
6.4	Register with AmbientWeather.net.....	35
6.5	Additional AmbientWeather.net Features.....	36
6.5.1	IFTTT.....	36
6.5.2	Compatible with Alexa.....	37
6.5.3	Works with Google Assistant	37
6.6	Advanced Settings.....	37
6.6.1	Calibration.....	38
6.6.2	Notes About Calibration.....	39
6.6.3	Calibrating the Wind Direction for the Southern Hemisphere	40
6.6.4	Firmware Updates	40
7	Maintenance.....	41
8	Battery Replacement	41
9	Adding or Subtracting Multiple Sensors.....	42
9.1	Adding or Subtracting Sensors.....	42
9.2	Optional Sensors	42
9.3	Assigning Optional Sensor Channels	43
10	Specifications	43
10.1	Wireless Specifications	43
10.2	Measurement Specifications.....	44
10.3	Power Consumption	44
10.4	Wi-Fi Specifications.....	44
10.5	Other Specifications	45
10.6	Weight Specifications.....	45
11	Troubleshooting Guide	45
12	Liability Disclaimer.....	47
13	FCC Statement.....	47
14	Warranty Information	48
15	California Prop 65	48

1. Introduction

Thank you for your purchase of the Ambient Weather WS-7079 Wi-Fi Smart Weather Station.

The following user guide provides step by step instructions for installation, operation and troubleshooting. To download the latest full-sized manual and additional troubleshooting tips, please visit:

<https://help.ambientweather.net/product/ws-7079>

2. Warnings

- ⚠ **Warning:** Only use the included approved AC adapter.
- ⚠ **Warning:** Any metal object may attract a lightning strike, including your weather station mounting pole. Never install the weather station in a storm.
- ⚠ **Warning:** Installing your weather station in a high location may result in injury or death. Perform as much of the initial check out and operation on the ground and inside a building or home. Only install the weather station on a clear, dry day.

3. Getting Started

Note: Remove the plastic film from the console face before getting started.

3.1 Parts List

QTY	Item
1	Display Console Frame Dimensions (L x W x H): 9.4 x 5.5 x 0.8 in
1	Wireless Outdoor Sensor Array (L x W x H): 13.5 x 15.5 x 5.4"
2	Rubber pads for pole mount.
1 set	Sensor array screw bolt, screws and screw nut
1 set	Sensor array mounting kit
1	UL Rated Class 6 AC Adapter
1	CR2032 Button Battery
1	User Manual

3.2 Tools

- Precision screwdriver
- Compass or GPS

3.3 Quick Start Guide

Although the manual is comprehensive, much of the information contained may be intuitive. In addition, the manual does not flow properly because the sections are organized by components.

The following Quick Start Guide provides only the necessary steps to install, operate the weather station, and upload to the internet, along with references to the pertinent sections.

✓	Step	Description	Section
	1	Assemble and power up the sensor array	3.5
	2	Power up the display console and synchronize with sensor array	3.5
	3	Mount the sensor array	3.5.4
	4	Set console settings	5
	5	Calibrate the relative pressure to sea-level conditions (local airport) on console	5.10.3
	6	Reset the rain to zero on console (due to movement during installation)	5.14.3
	7	Register at Wunderground.com (optional)	6.4
	8	Configure Wi-Fi, Server Settings, and Location	6.2
	9	Register at AmbientWeather.net	6.3

3.4 Product Features

3.4.1 Display

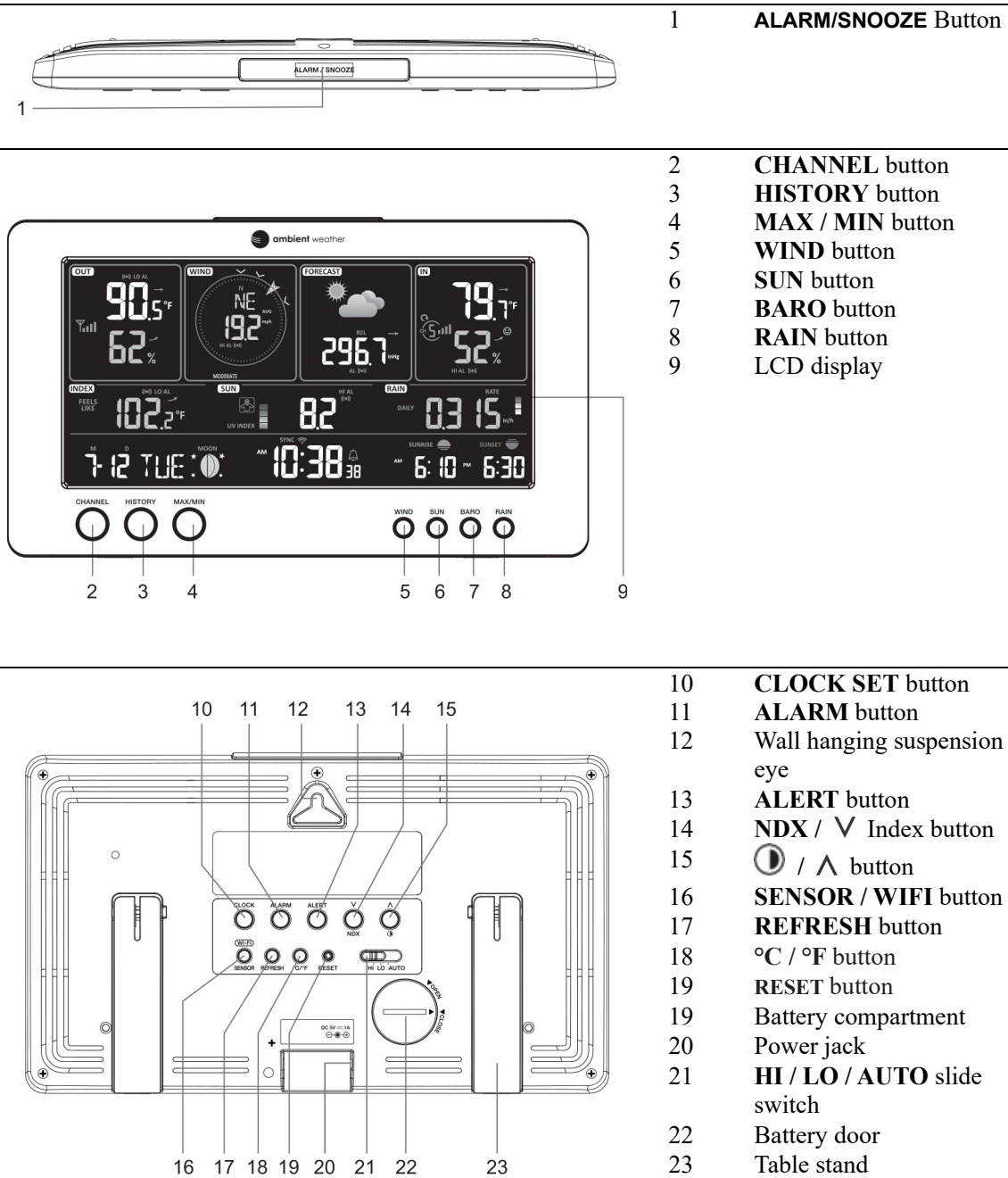

Figure 1

3.4.2 Sensor Array

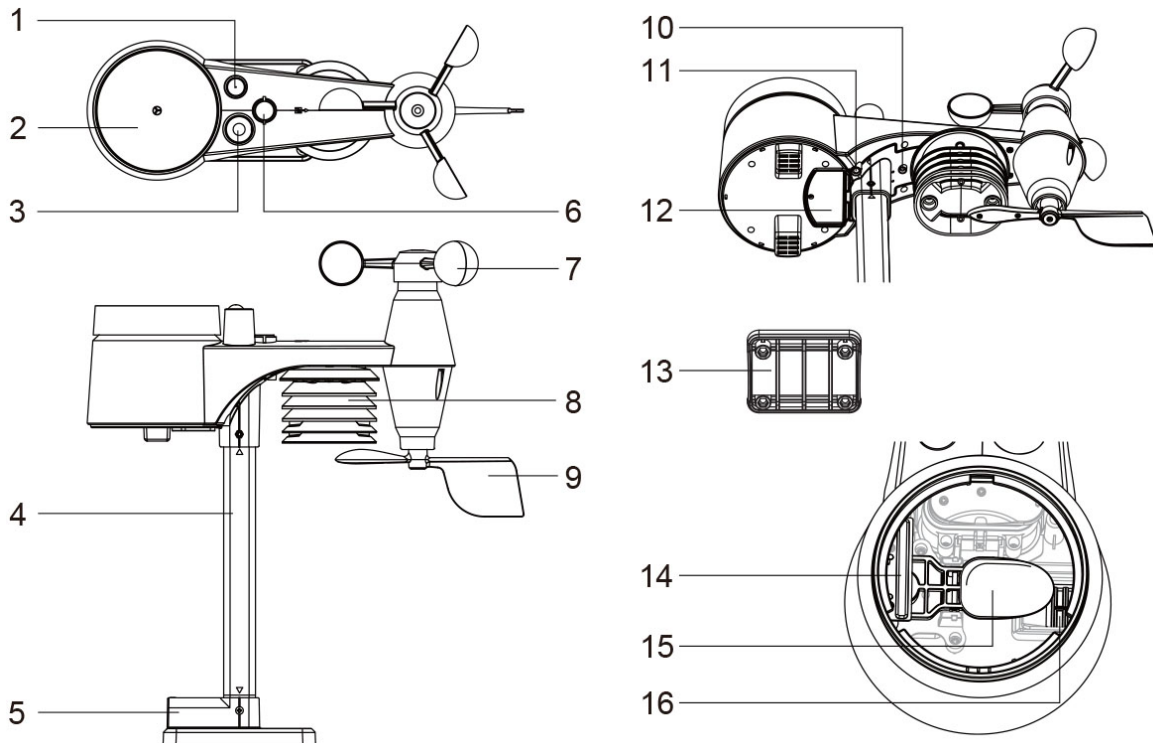



Figure 2

No	Description	No	Description
1	Antenna	9	Wind vane
2	Rain collector	10	Red LED indicator
3	UV / light sensor	11	[RESET] button
4	Mounting pole	12	Battery door
5	Mounting base	13	Mounting clamp
6	Balance indicator	14	Rain sensor
7	Wind cups	15	Tipping bucket
8	Radiation shield	16	Drain holes

3.5 Powering Up

3.5.1 Power Up Sequence

 **Note:** The power up sequence must be performed in the order shown in this section sensor array **FIRST**, display console **SECOND**) to avoid sensor synchronization time out.

The Outdoor Sensor Array:

1. Unscrew the battery door at the bottom of the sensor array and insert 3 x AA batteries

according to the polarity information marked on the battery compartment.

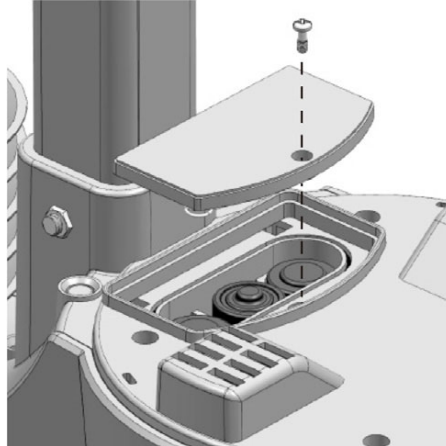

Figure 3

2. Replace the battery door and screw on tightly.
3. The transmission status LED will begin flashing once per 12 seconds.

The Console:

Important Note: The power up sequence must be performed in this order (battery first, AC adaptor second) to prevent a low battery indication at power up.

Place the sensor array about 5 to 10 feet from the display console.

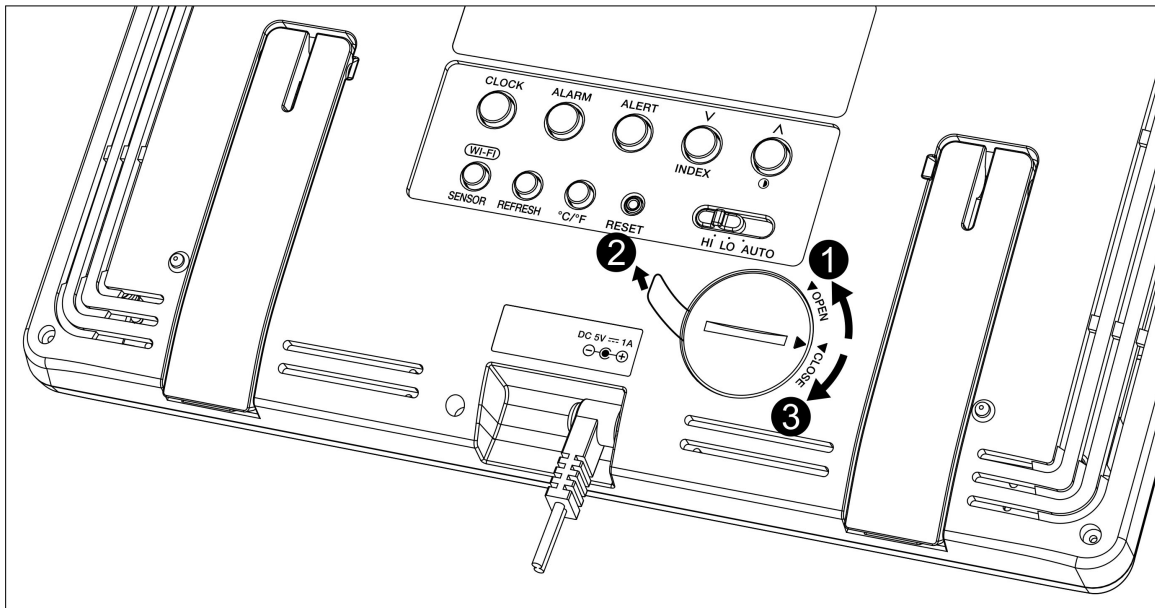



Figure 4

1. Reference Figure 4. Rotate the battery lid counter-clockwise to open the battery door.
2. Gently pull out the battery pull tab.
3. Rotate the battery lid clockwise to close the battery door.
4. Plug the AC adaptor into the DC jack of the console.
5. After power up, all of LCD segments will be displayed. The console will enter access point (AP) mode, and the status LED will flash green.
6. **Do not touch any buttons until sensor synchronization is complete.**

 **Note:** If no display is present after powering up the console, press the **[RESET]** button on the back of the console with an open-ended paper clip or sharp tool.

3.5.2 Initial Sensor Synchronization

The console will automatically search for and connect to the optional sensors and outdoor sensor array after it is powered up. You can also press **[Wi-Fi / SENSOR]** button to force the console to search for the sensors.

Once the sensor array connection is successful, the antenna mark and readings for outdoor temperature, humidity, wind speed, wind direction, rainfall and UV will appear on the display.

3.5.3 Site Survey

Perform a site survey before installing the sensor array. Consider the following:

1. You must clean the rain gauge every few months and change the batteries every 2-3 years. Provide easy access to the weather station.
2. Avoid radiant heat transfer from buildings and structures. In general, install the sensor array at least 5' from any building, structure, ground, or roof top.
3. Avoid wind and rain obstructions. The rule-of-thumb is to install the sensor array at least four times the difference in the height of the sensor array and that of the tallest obstruction. For example, if the building is 20' tall, and the mounting pole is 6' tall, install $4 \times (20 - 6) = 56'$ away.
4. Wireless Range. The radio communication between receiver and transmitter in an open field can reach a distance of up to 300 feet, providing there are no interfering obstacles such as buildings, trees, vehicles, high voltage lines. Wireless signals will not penetrate metal buildings. Under most conditions, the maximum wireless range is 100'.
5. Radio interference such as PCs, radios or TV sets can, in the worst case, entirely cut off radio communication. Please take this into consideration when choosing console or mounting locations. Make sure your display console is at least five feet away from any electronic device to avoid interference.
6. Visit Ambient Weather Mounting Solutions for assistance and ideas for mounting your weather station:

<http://www.ambientweather.com/amwemoso.html>

3.5.4 Pole Mounting the Sensor Array

The sensor array includes an easy mounting bracket for mounting to any pole between 1" and 2". If your pole diameter is greater than 2", consider a mast-to-mast mounting bracket and standard 1 3/8" pole available from Ambient Weather.

Mount the sensor array mounting bracket to your pole (**not included**) using a Philips screwdriver. Tighten the bolts to the nuts seated inside the hexagonal bolt wells. Add the included rubber gripping pads to the bracket.

Before completely tightening, point the wind vane to the North (solar panel to the South), as shown in Figure 5, Step 5.

Step	Image
------	-------

Step 1:

Insert the top side of the pole to the square hole of the weather sensor.

 Note: Ensure the pole and sensor's indicator align.

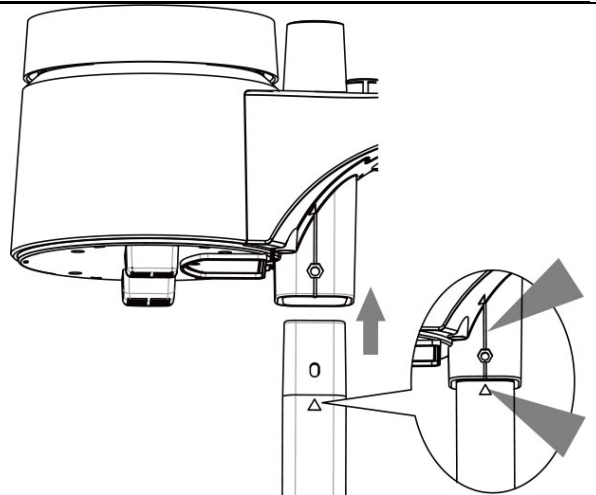
**Step 2:**

Place the nut in the hexagon hole on the sensor array, then insert the screw in other side and tighten it with a precision screwdriver.

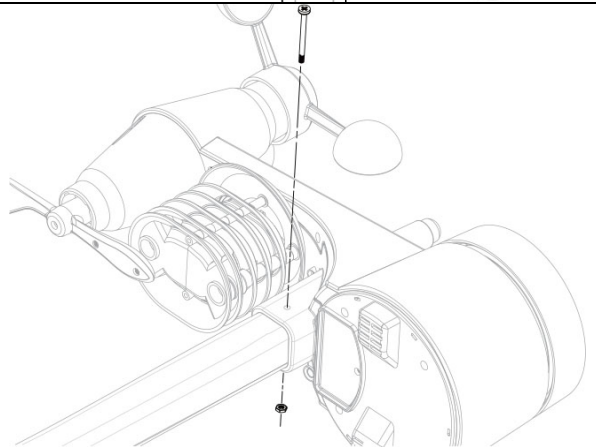
**Step 3:**

Insert the other side of the pole to the square hole of the plastic stand.

 Note: Ensure the pole and stand's indicator align.

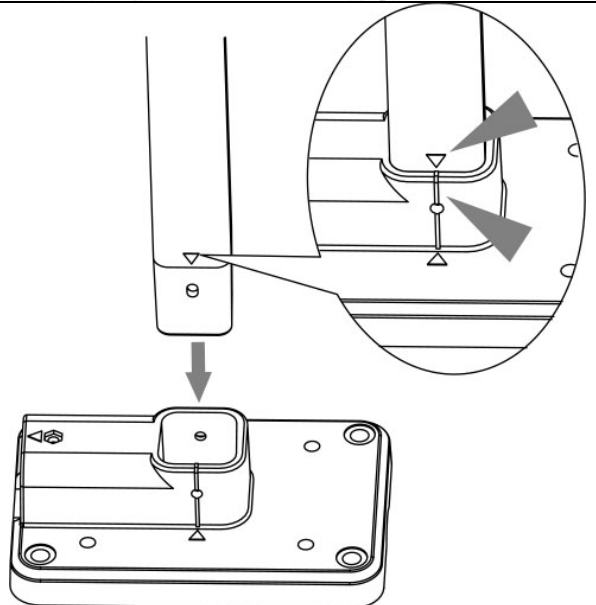

<p>Step 4: Place the nut in the hexagon hole of the stand, then insert the screw in the other side, and then tighten with a precision screwdriver.</p>	
<p>Step 5: Install the sensor array in an open area with no obstructions above or around the sensor array for accurate rain and wind measurement.</p> <p>Install the sensor array with the anemometer (wind sensors) facing North to properly orient the wind direction vane.</p> <p>Secure the mounting stand and clamps (included) to a post or pole, and allow minimum 5 feet off the ground.</p>	

Figure 5

The mounting pole can be attached to a railing or another pole, as shown in Figure 6.

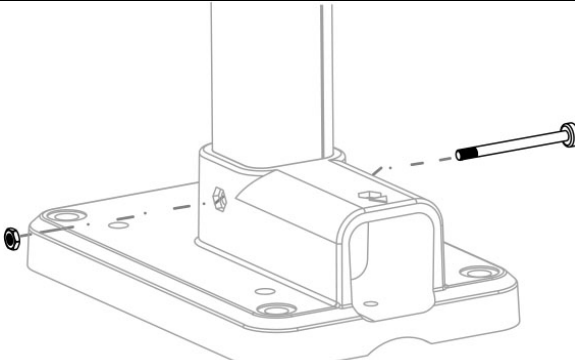
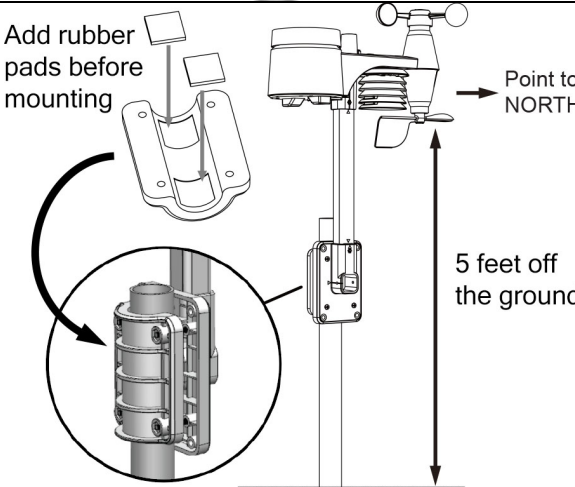
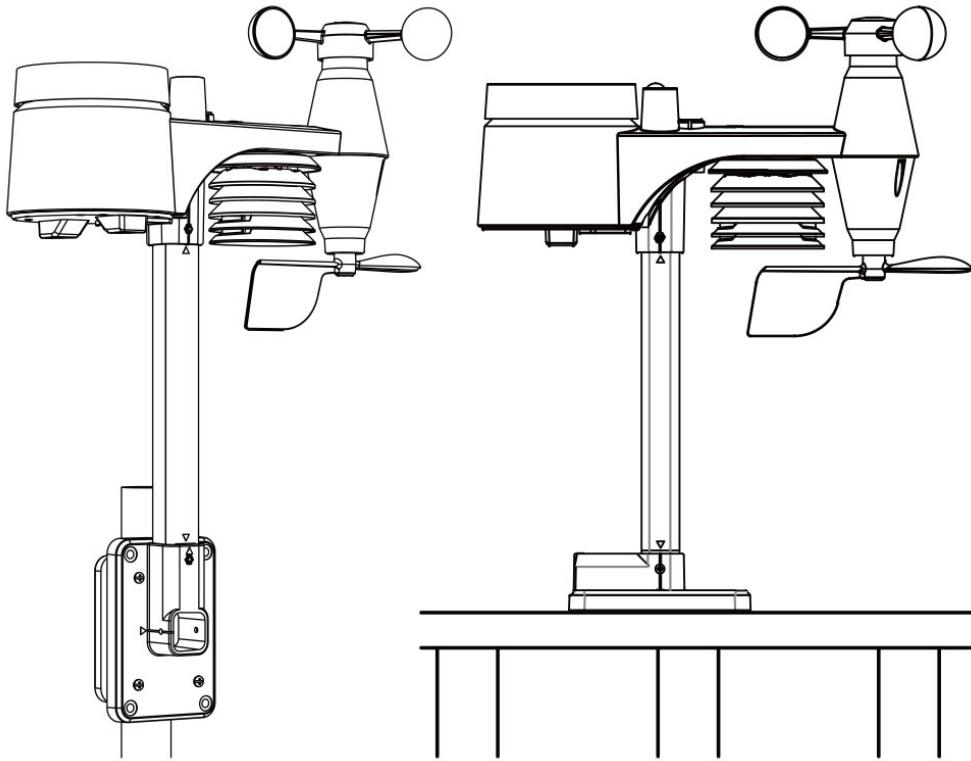
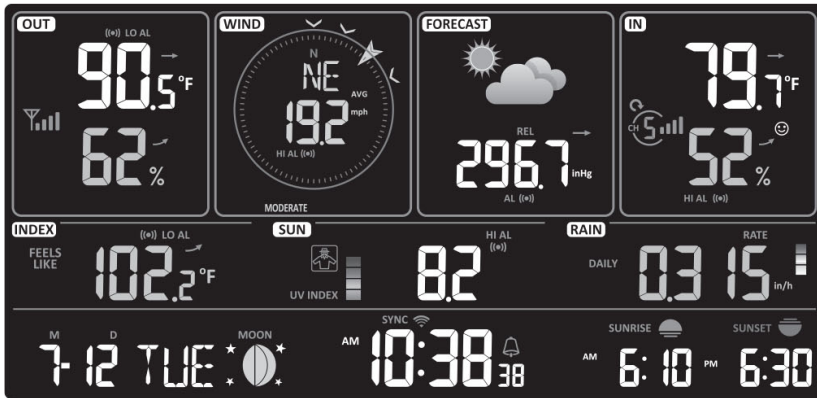

Figure 6

4. Console Display



1	2	3	4
5	6	7	
8	9	10	









No	Description	No	Description
1	Outdoor temperature & humidity.	6	Sun (UV, Light Intensity, Sunburn Time)
2	Wind direction & speed	7	Rain
3	Forecast and barometer	8	Calendar and Moon Phase
4	Indoor temperature & humidity. The sensors are located inside the display console.	9	Time and Alarm
5	Feels Like Temperature Heat Index & Wind Chill)	10	Sunrise and Sunset



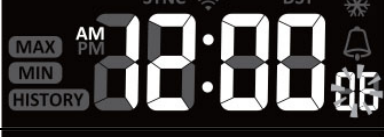

Figure 7

5. Settings

5.1 Time Settings

While in normal time mode, perform the following operations to set the time. Note that once connected to the Internet, and you set the correct time zone (TZ) and daylight savings time (DST), the time will set automatically.

Command	Mode	Settings	Image
[CLOCK SET] + 2 seconds	Enter Time Zone Settings	Press [^] to increase, [v] to decrease. Reference Figure 9.	
[CLOCKSET]	Enter Daylight Savings Time OFF (AZ and HI) or auto (everywhere else).	Press [^] or [v] to turn ON or OFF.	
[CLOCKSET]	Hour	Press [^] to increase, [v] to decrease.	
[CLOCKSET]	Minute	Press [^] to increase, [v] to decrease.	
[CLOCKSET]	Second	Press [^] to reset to 0.	
[CLOCKSET]	Hour Format	Press [^] to toggle between 12 Hr and 24 Hr format.	 
[CLOCKSET]	Year	Press [^] to increase, [v] to decrease.	
[CLOCKSET]	Month	Press [^] to increase, [v] to decrease.	

[CLOCKSET]	Day	Press [^] to increase, [v] to decrease.	
[CLOCKSET]	Month Day Format	Press [^] or [v] to toggle between M-D (month-day) and D-M (day-month)	 
[CLOCKSET]	Enable or disable the internet time sync	Press [^] or [v] to turn ON or OFF	
[CLOCKSET]	Language	Press [^] or [v] to change between EN (English), DE (German), FR (French), ES (Spanish) IT (Italian), NL (Dutch), and RU (Russian)	
[CLOCKSET]	Exit Time Settings		

[CLOCKSET] + 2 seconds means press and hold the **CLOCKSET** button on the back of the display console for two seconds.

[CLOCKSET] means press but do not hold the **CLOCKSET** button.

Figure 8

5.1.1 Time Zone Settings

The following table provides times zones throughout the world. Locations in the eastern hemisphere are positive, and locations in the western hemisphere are negative.

Hours from GMT	Time Zone	Cities
-12	IDLW: International Date Line West	---
-11	NT: Nome	Nome, AK
-10	AHST: Alaska-Hawaii Standard CAT: Central Alaska HST: Hawaii Standard	Honolulu, HI
-9	YST: Yukon Standard	Yukon Territory

Hours from GMT	Time Zone	Cities
-8	PST: Pacific Standard	Los Angeles, CA, USA
-7	MST: Mountain Standard	Denver, CO, USA
-6	CST: Central Standard	Chicago, IL, USA
-5	EST: Eastern Standard	New York, NY, USA
-4	AST: Atlantic Standard	Caracas
-3	---	São Paulo, Brazil
-2	AT: Azores	Azores, Cape Verde Islands
-1	WAT: West Africa	---
0	GMT: Greenwich Mean WET: Western European	London, England
1	CET: Central European	Paris, France
2	EET: Eastern European	Athens, Greece
3	BT: Baghdad	Moscow, Russia
4	---	Abu Dhabi, UAE
5	---	Tashkent
6	---	Astana
7	---	Bangkok
8	CCT: China Coast	Beijing
9	JST: Japan Standard	Tokyo
10	GST: Guam Standard	Sydney
11	---	Magadan
12	IDLE: International Date Line East NZST: New Zealand Standard	Wellington, New Zealand

Figure 9

5.2 Month Day vs. Year Display

To change the date field from Month / Day to Year, press (do not hold) the **CLOCK** button.

5.3 Moon Phase

The phase of the moon is determined by the time, date and time zone. Figure 10 displays the moon phases for the Northern and Southern Hemisphere.

Reference the web setup interface (Figure 42) for selecting Northern or Southern Hemisphere.













Northern hemisphere	Moon Phase	Southern hemisphere
	New Moon	
	Waxing Crescent	
	First quarter	
	Waxing Gibbous	
	Full Moon	
	Waning Gibbous	
	Third quarter	
	Waning Crescent	

Figure 10

5.4 Sunrise and Sunset

The console calculates your location's sunrise and sunset time based on your time zone, latitude and longitude you entered.

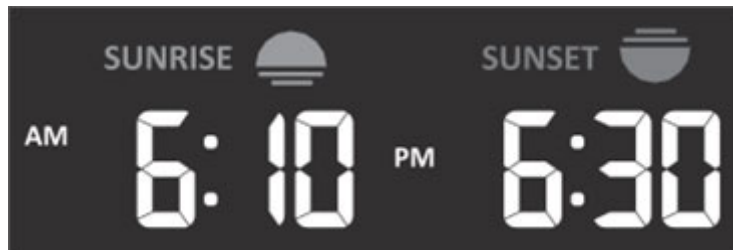



Figure 11

5.5 Wi-Fi Connection Status

When the console successfully connects to your Wi-Fi router, the Wi-Fi signal icon  will appear in the time field on the LCD display. If the Wi-Fi signal is not stable or the console is trying to connect to the router, the icon will flash. If the icon disappears, it means the console is not connected to the Wi-Fi router.

5.6 Time Server Sync Status



After the console has connected to the internet, it will attempt to connect to the internet time server to obtain the UTC time. Once the connection succeeds and the console's time has been updated, the **SYNC** icon will appear in the Time field of the display. If the console cannot sync the time server, you can press the **REFRESH** button to force the time synchronization process, and the SYNC icon will flash.



Figure 12

5.7 Alarm Settings

5.7.1 Turning on and Off the Alarm Feature

In normal mode, press the **ALARM** button to show the alarm time. Press the alarm button again, and the alarm icon  will appear. Press the alarm button again, and the pre-alert icon  will appear. Press the alarm button again, and the alarm and pre-alert to turn off, and no alarm will sound.

		
Alarm off	Alarm on	Alarm with ice-alert

Figure 13

5.7.1.1 Pre-Alert Feature

The pre-alert wakes you 30 minutes earlier if ice is predicted to allow you extra time to get to work or school.

Once the ice pre-alert is activated, the alarm will sound 30 minutes earlier if the outdoor temperature is below -3°C (26.6 °F), where ice is likely to form.

5.7.2 Setting the Alarm Time

While in normal mode, perform the following operations to set the alarm time.

Command	Mode	Settings
[ALARM] + 2 seconds	Enter Alarm Settings Alarm Hour	Press [UP] to increase, [DOWN] to decrease.
[ALARM]	Alarm Minute	Press [UP] to increase, [DOWN] to decrease.
[ALARM]	Exit Alarm Settings	

[ALARM] + 2 seconds means press and hold the ALARM button on the back of the display for two seconds.

[ALARM] means press but do not hold the ALARM button on the back of the display.

Figure 14

5.7.3 Using the Alarm and Snooze Functions

When the alarm sounds, press and hold the **ALARM / SNOOZE** button for two seconds to turn off the alarm sound. The alarm bell will stop flashing.

If no button is pressed during the alarm period, the alarm will turn off automatically after two minutes.

To temporarily silence the alarm, press the **ALARM / SNOOZE** button on the top of the console. The alarm bell icon will keep flashing.

If the snooze function is turned on, the 4-step crescendo alarm will sound every 2 minutes. Press and

hold the **ALARM / SNOOZE** button for two seconds to turn off the alarm sound. The alarm bell will stop flashing.

5.8 Temperature and Humidity Display and Settings

5.8.1 Temperature Units of Measure

Press the °F / °C button on the front of the display to change the temperature units of measure.

5.8.2 Outdoor Sensor Array Signal Strength

The outdoor sensor array signal strength is displayed in the outdoor section of the display:

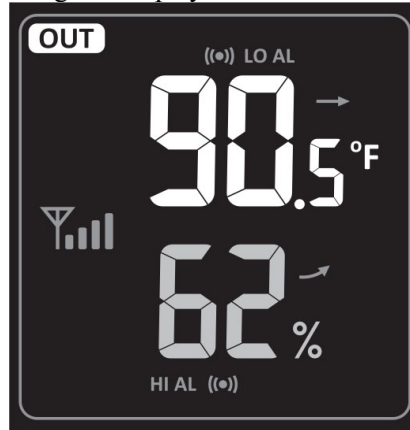

		
No signal	Weak signal	Good signal

Figure 15

5.8.3 Optional 7-Channel Sensors

5.8.3.1 Channel Sensor Signal Strength

The channel sensor signal strength is displayed in the indoor section of the display, next to the channel number:



		
No signal	Weak signal	Good signal

Figure 16

5.8.3.2 Changing Channel Numbers

The console supports up to seven optional wireless indoor and outdoor sensors. If you have two or more sensors, press the **CHANNEL** button to switch to different channels.

Press and hold the **CHANNEL** button for two seconds to automatically scroll between the channels every four seconds. To stop the automatic scrolling, press the **CHANNEL** button again.

5.8.3.3 Indoor Comfort Icon

The comfort indication is a pictorial indication calculated from the indoor air temperature and humidity. Each channel displays a comfort icon.

The comfort indication can vary at the same temperature, depending on the humidity. There is no comfort Indication when the temperature is below 0°C (32°F) or over 60°C (140°F).

		
Too cold	Comfortable	Too hot

Figure 17

5.8.4 Temperature and Humidity Trend

The temperature trend arrow indicator displays the current rate of change of the indoor and outdoor temperature and humidity.

Arrow indicator			
Trend	Rising	Steady	Falling

Figure 18

5.8.5 Temperature and Humidity Measurements Limits

When temperature is below -40 °C, (-40 °F), the LCD will display “Lo”. If temperature is above 80 °C (176 °F), LCD will display “HI”.

When humidity is below 1%, the LCD will display “Lo”. If humidity is above 99%, the LCD will display “HI”.

5.9 Wind

The wind section displays wind speed (gust or average), current wind direction, predominant wind direction (over the last 5 minutes), and wind speed level.

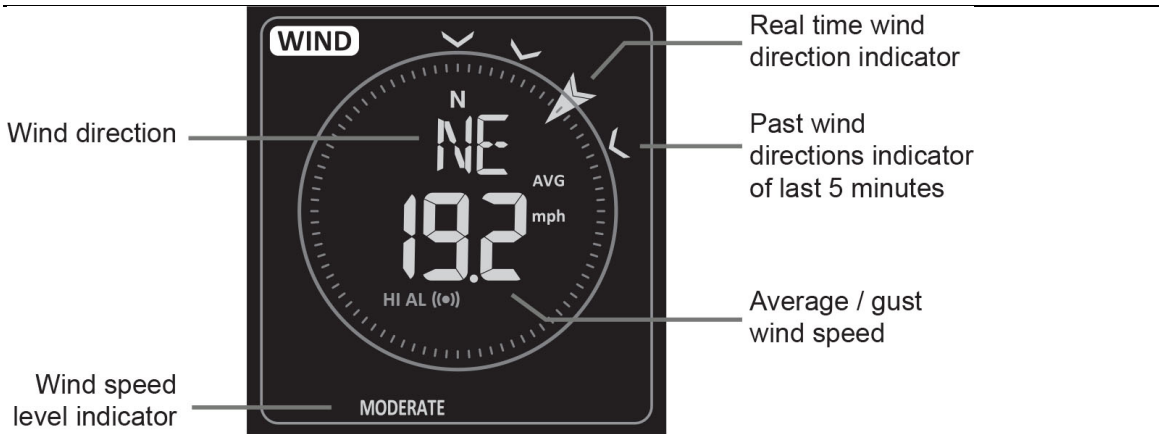

Figure 19

5.9.1 Average Wind Speed, Wind Gust and Beaufort Scale

To change the display between average wind speed, wind gust and Beaufort scale, press the **WIND** button on the front of the display.

The wind speed is the average calculated by the sensor array in the 12 second update period. The wind gust is the maximum calculated by the sensor array in the 12 second update period, and then passed to the console. Thus, you never miss a wind gust.

The Beaufort Scale is an international scale of wind velocities ranging from 0 (calm) to 12 (Hurricane force).

The Beaufort Scale is defined as follows:

Beaufort Scale	Description	Wind Speed	Land Condition
0	Calm	< 1 km/h	Calm. Smoke rises vertically.
		< 1 mph	
		< 1 knot	
		< 0.3 m/s	
1	Light air	1.1 - 5.5 km/h	Smoke drift indicates wind direction. Leaves and wind vanes are stationary.
		1 - 3 mph	
		1 - 3 knot	
		0.3 - 1.5 m/s	
2	Light breeze	5.6 - 11 km/h	Wind felt on exposed skin. Leaves rustle. Wind vanes begin to move.
		4 - 7 mph	
		4 - 6 knot	
		1.6 - 3.3 m/s	
3	Gentle breeze	12 - 19 km/h	Leaves and small twigs constantly moving, light flags extended.
		8 - 12 mph	
		7 - 10 knot	
		3.4 - 5.4 m/s	
4	Moderate breeze	20 - 28 km/h	Dust and loose paper raised. Small branches begin to move.
		13 - 17 mph	
		11 - 16 knot	
		5.5 - 7.9 m/s	
5	Fresh breeze	29 - 38 km/h	Branches of a moderate

		18 - 24 mph	size move. Small trees in leaf begin to sway.
		17 - 21 knot	
		8.0 - 10.7 m/s	
6	Strong breeze	39 - 49 km/h	Large branches in motion. Whistling heard in overhead wires. Umbrella use becomes difficult. Empty plastic bins tip over.
		25 - 30 mph	
		22 - 27 knot	
		10.8 - 13.8 m/s	
7	High wind	50 - 61 km/h	Whole trees in motion. Effort needed to walk against the wind.
		31 - 38 mph	
		28 - 33 knot	
		13.9 - 17.1 m/s	
8	Gale	62 - 74 km/h	Some twigs broken from trees. Cars veer on road. Progress on foot is seriously impeded
		39 - 46 mph	
		34 - 40 knot	
		17.2 - 20.7 m/s	
9	Strong gale	75 - 88 km/h	Some branches break off trees, and some small trees blow over. Construction /temporary signs and barricades blow over.
		47 - 54 mph	
		41 - 47 knot	
		20.8 - 24.4 m/s	
10	Storm	89 - 102 km/h	Trees are broken off or uprooted, structural damage likely.
		55 - 63 mph	
		48 - 55 knot	
		24.5 - 28.4 m/s	
11	Violent storm	103 - 117 km/h	Widespread vegetation and structural damage likely.
		64 - 73 mph	
		56 - 63 knot	
		28.5 - 32.6 m/s	
12	Hurricane force	≥ 118 km/h	Severe widespread damage to vegetation and structures. Debris and unsecured objects are hurled about.
		≥ 74 mph	
		≥ 64 knot	
		≥ 32.7m/s	

Figure 20

5.9.2 Wind Units of Measure and Wind Direction Format

While in normal mode, perform the following operations to change the wind settings.

Command	Mode	Settings
[WIND] + 2 seconds	Enter Wind Settings Wind Speed Units of Measure	Press [^] to change between m/s → km/h → knots → mph
[WIND]	Wind Direction Format	Press [^] to change between degrees (0-360°) and 16-point compass direction.
[WIND]	Exit Wind Settings	

[WIND] + 2 seconds means press and hold the **WIND** button on the front of the display for two

seconds.

[WIND] means press but do not hold the **WIND** button on the front of the display.

5.9.3 Wind Speed Level Indicator

The wind speed level is based on the Beaufort scale, and is displayed at the bottom of the **WIND** field:

Level	LIGHT	MODERATE	STRONG	STORM
Speed	0.1km/h ~19km/h	20km/h ~ 49km/h	50km/h ~ 88km/h	> 89km/h

Figure 21

5.10 Barometric Pressure Display and Settings



Note: The barometric pressure sensor is inside the console. Barometric pressure is the same inside or outside of your home or facility.

5.10.1 Barometric Pressure Units of Measure

In normal time mode, press the **BARO** button (on the front of the console) to change barometric units of measure (hPa / inHg / mmHg).

5.10.2 Absolute Pressure vs. Relative Pressure

Press and hold the **BARO** button for 2 seconds to switch between relative pressure and absolute pressure.

5.10.3 Relative Pressure Calibration

Please Reference Section 6.6.1 for details on relative pressure calibration, the purpose of calibrating relative pressure, and how to determine relative pressure in your area.

5.10.3.1 Relative vs. Absolute Pressure and Calibration

The console displays two different pressures: absolute (measured) and relative (corrected to sea-level).

To compare pressure conditions from one location to another, meteorologists' correct pressure to sea-level conditions. Because the air pressure decreases as you rise in altitude, the sea-level corrected relative pressure (the pressure your location would be at if located at sea-level) is generally higher than your measured absolute pressure.

Thus, your absolute pressure may read 28.62 inHg (969 mb) at an altitude of 1000 feet (305 m), but the relative pressure is 30.00 inHg (1016 mb).

The standard sea-level pressure is 29.92 in Hg (1013 mb). This is the average sea-level pressure around the world. Relative pressure measurements greater than 29.92 inHg (1013 mb) are considered high pressure and relative pressure measurements less than 29.92 inHg are considered low pressure.

5.11 The Forecast

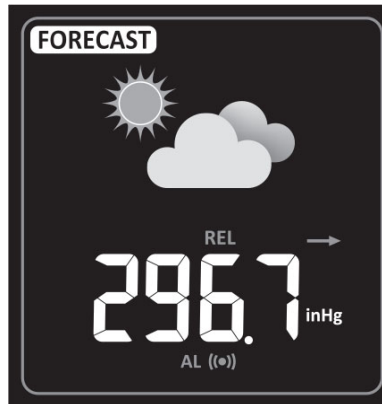

Figure 22

The weather forecast or pressure tendency is based on the rate of change of barometric pressure. In general, when the pressure increases, the weather improves (sunny to partly cloudy) and when the pressure decreases, the weather degrades (cloudy to rain).

When the pressure drops rapidly, the storm icon will be displayed.

It may take several days to begin forecasting the weather. In the meantime, the partly cloudy icon will be displayed.

The weather forecast is an estimation or generalization of weather changes in the next 12 to 48 hours and varies from location to location. The tendency is simply a tool for projecting weather conditions and is never to be relied upon as an accurate method to predict the weather.

The “Snowy” weather forecast is based on the outdoor temperature and will be displayed when the outdoor temperature is below -3°C (26°F).

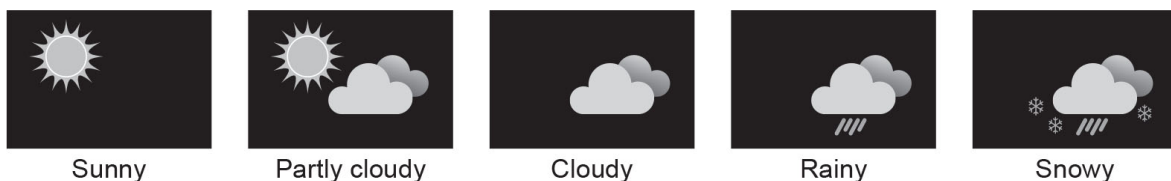

Figure 23

5.12 Weather Index

The Weather Index displays the parameters Feels Like, Dew Point, Heat Index, and Wind Chill.

In normal mode, press the **INDEX** button on the front of the display to view the following parameter in this sequence:

FEELS LIKE → DEW POINT → HEAT INDEX → WIND CHILL → FEELS LIKE

5.13 Feels Like

Feels like is a combination of Wind Chill and Heat Index.

For temperatures less than 18°C (64°F), wind chill is displayed.

For temperatures greater than 26°C (79°F), heat index is displayed.

Between 18 °C and 26 °C, the outdoor temperature is shown.

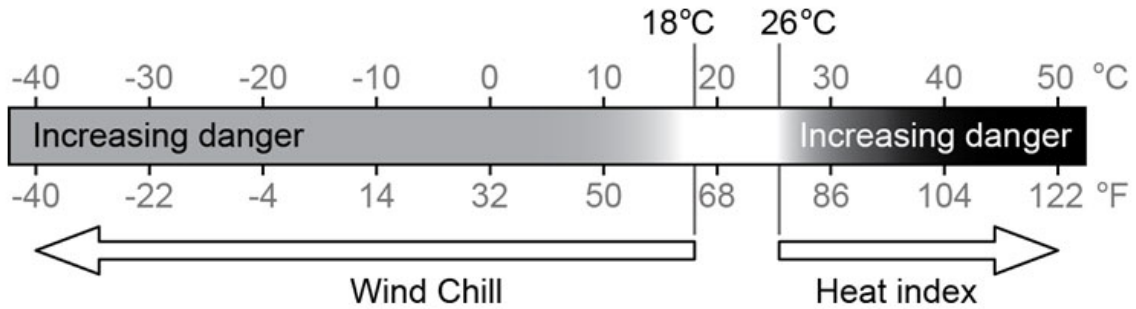

Figure 24

Note: The National Weather Service defines the maximum wind chill temperature of 40° F and a minimum heat index temperature of 80°F. We extend this range from 64 °F to 79 °F to make it more interesting to the end user by curve fitting the national weather service’s tables.

5.13.1 UV Index, Light Intensity and Sunburn Time

The Sun field displays Light Intensity, UV Index and Sunburn Time. Press the **SUN** button on the front of the display to switch the view between UV, Light Intensity and Sunburn Time.

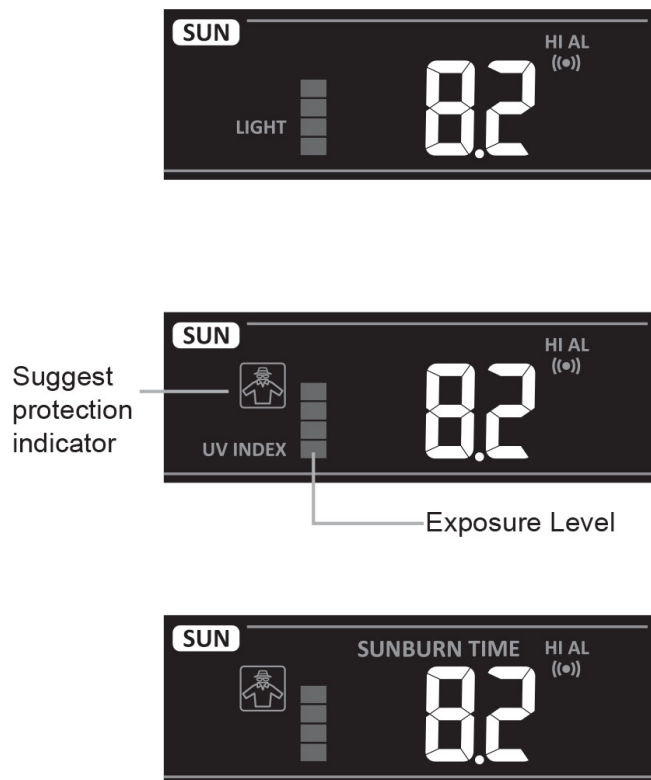

Figure 25

5.13.1.1 Light Intensity Units of Measure

With the Light Intensity displayed (see previous section), to change the units of measure:

1. Press and hold the **SUN** button for two seconds and the units of measure will flash.
2. Press the [**Λ**] button to switch the units of measure between Klux, Kfc and W/m².
3. Press the **SUN** button to confirm and save settings.

5.13.1.2 Sunburn Time

The sunburn time is calculated from UV. The sunburn time is based on Caucasian skin. In general, the darker the skin pigment, the longer the sunburn time.

A sun protection icon appears when the UV index is moderate to extreme.



Exposure level	Low		Moderate			High		Very high			Extreme	
UV index	1	2	3	4	5	6	7	8	9	10	11	12~16
Sunburn time	N/A		45 minutes			30 minutes		15 minutes			10 minutes	
Recommended protection indicator	N/A		Moderate or high UV level. Wear sunglasses, broad rim hat and long-sleeved shirts .					Very high or Extreme UV level. Wear sunglasses, broad rim hat and long-sleeved shirts. If you must be outdoors, seek shade .			 	

Figure 26

The US EPA defines the UVI as follows:

UVI	Rating	Comments
0-2	Low	A UV Index reading of 0 to 2 means low danger from the sun's UV rays for the average person.
3-5	Medium	A UV Index reading of 3 to 5 means moderate risk of harm from unprotected sun exposure.
6-7	High	A UV Index reading of 6 to 7 means high risk of harm from unprotected sun exposure. Protection against skin and eye damage is needed.
8-10	Very High	A UV Index reading of 8 to 10 means very high risk of harm from unprotected sun exposure. Take extra precautions because unprotected skin and eyes will be damaged and can burn quickly.
11-16	Extreme	A UV Index reading of 11 or more means extreme risk of harm from unprotected sun exposure. Take all precautions because unprotected skin and eyes can burn in minutes.

Figure 27

5.13.1.3 UV Bar Graph

The console also includes a UV bar chart with the following color codes:



UV	Exposure level	Color
0	-	-
0.1 to 2.9	Low	Green
3.0 to 5.9	Moderate	Yellow
6.0 to 7.9	High	Orange
8.0 to 10.9	Very High	Red
≥11.0	Extreme	Purple

Figure 28

5.13.2 Wind Chill

Wind Chill is the perceived decrease in air temperature felt by the body on exposed skin due to the flow of air and is calculated based on temperature and wind speed.

Wind chill numbers are always lower than the air temperature for values where the formula is valid.

The wind chill calculation is only valid for temperatures less than 40 °F and wind speeds greater than 0 mph, according to the National Weather Service.

5.13.3 Heat Index

Heat Index is an index that combines air temperature and relative humidity, as an attempt to determine the human-perceived equivalent temperature.

The heat index calculation is only valid for temperatures greater than 80 °F and less than 120 °F, and humidity greater than 40%, according to the National Weather Service. If it is below 80 °F, the console will display Lo.

Level	Heat Index Range (°F)	Notes
Caution	80-90	Fatigue is possible with prolonged exposure and activity. Continuing activity could result in heat cramps.
Extreme Caution	90-105	Heat cramps and heat exhaustion are possible. Continuing activity could result in heat stroke.
Danger	105-130	Heat cramps and heat exhaustion are likely; heat stroke is probable with continued activity.
Extreme Danger	Over 130	Heat stroke is imminent.

Figure 29

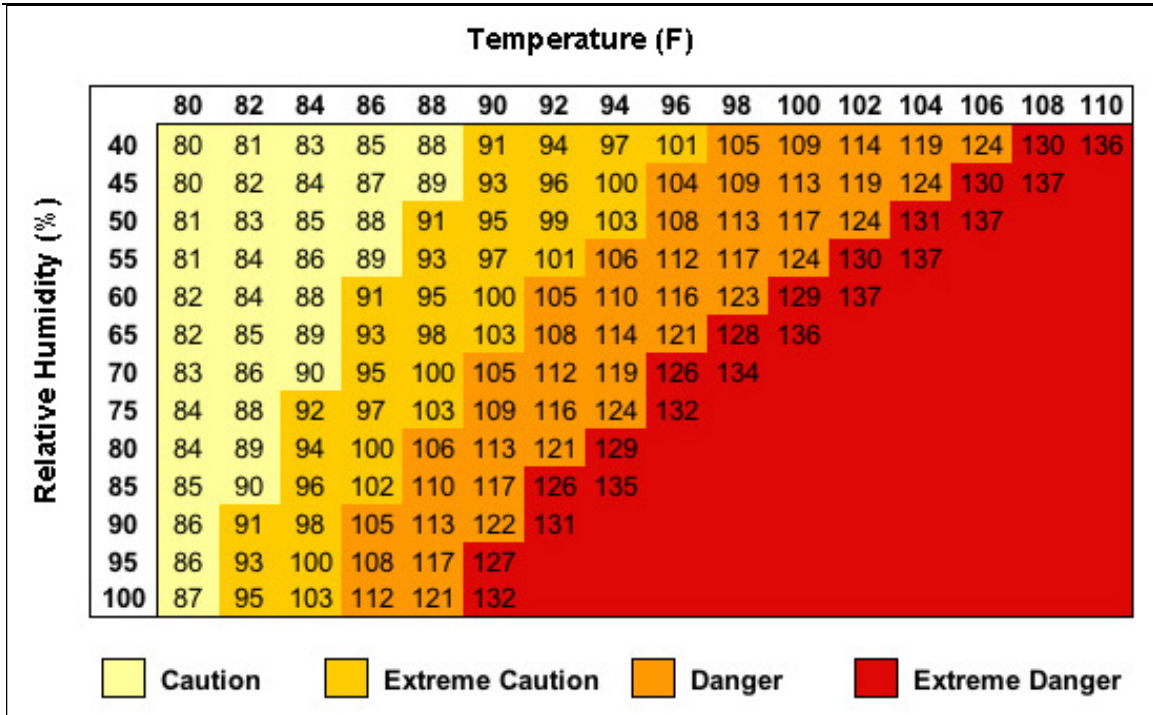

Figure 30

5.13.4 Dew Point

The dew point is the temperature below which the water vapor in air at constant barometric pressure condenses into liquid water at the same rate at which it evaporates. The condensed water is called dew when it forms on a solid surface.

The dew point temperature is determined by the temperature & humidity data from outdoor sensor.

5.14 Rainfall

The rainfall displays total rain (since the last reset), hourly, daily, weekly, or monthly rain.

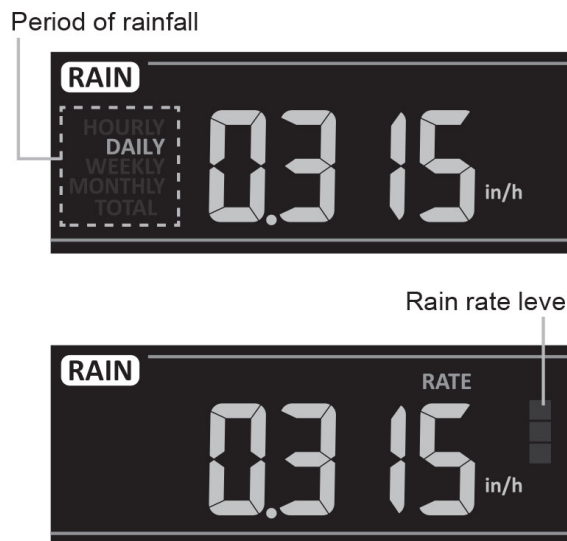

Figure 31

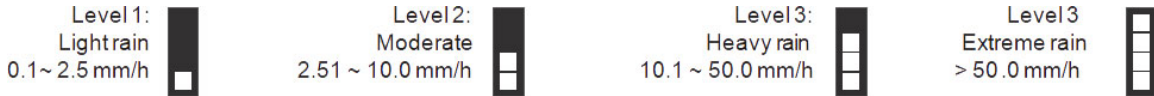

Figure 32

5.14.1 Rain Units of Measure

Command	Mode	Settings
[RAIN] + 2 seconds	Enter Rain Settings Rain Units of Measure	Press [^] to change between mm → inch
[RAIN]	Exit Rain Settings	

[RAIN] + 2 seconds means press and hold the **RAINFALL** button on the top of the display for two seconds.

[RAIN] means press but do not hold the **RAINFALL** button on the top of the display.

5.14.2 Rain Increments of Measure

Press (do not hold) the **RAIN** button to change increments of measure between

1. **DAILY** - the total rainfall from midnight
2. **HOURLY** - the total rainfall in the past hour
3. **WEEKLY** - the total rainfall of the current week
4. **MONTHLY** - the total rainfall of the current calendar month
5. **TOTAL** – the total rainfall since the last reset.
6. **RATE** – rainfall rate in the last 10 minutes x 6

5.14.3 Resetting Rain to Zero

In normal mode, press and hold the **HISTORY** button with 2 sec to reset the rainfall record.

5.15 Min / Max

Press (do not hold) the **MAX / MIN** button on the front of the display to review the following:

Command	Parameter
[MAX/MIN]	Outdoor MAX temperature
[MAX/MIN]	Outdoor MIN temperature
[MAX/MIN]	Outdoor MAX humidity
[MAX/MIN]	Outdoor MIN humidity
[MAX/MIN]	Indoor MAX temperature for the current channel displayed
[MAX/MIN]	Indoor MIN temperature for the current channel displayed
[MAX/MIN]	Indoor MAX humidity for the current channel displayed
[MAX/MIN]	Indoor MIN humidity for the current channel displayed
[MAX/MIN]	MAX Average Wind Speed
[MAX/MIN]	MAX Wind Gust
[MAX/MIN]	MAX Feels Like
[MAX/MIN]	MIN Feels Like

[MAX/MIN]	MAX Dew Point
[MAX/MIN]	MIN Dew Point
[MAX/MIN]	MAX Heat Index
[MAX/MIN]	MIN Heat Index
[MAX/MIN]	MAX Wind Chill
[MAX/MIN]	MIN Wind Chill
[MAX/MIN]	MAX UV Index
[MAX/MIN]	MAX Light Intensity
[MAX/MIN]	MAX Relative Pressure
[MAX/MIN]	MIN Relative Pressure
[MAX/MIN]	MAX Absolute Pressure
[MAX/MIN]	MIN Absolute Pressure
[MAX/MIN]	MAX Rain Rate

[MAX/MIN] means press the MAX/MIN button

To reset the current display min and max records manually, press and hold the **MAX / MIN** button for two seconds to reset the MAX/MIN records.

The LCD will also display the Max or Min icon   data records with the associated date and time.

5.16 History Data (Past 24 hours)

The console automatically stores the weather data of the past 24 hours. Press the **HISTORY** repeatedly button to review historical data every hour, on the hour, for the last 24 hours.

The console displays indoor and outdoor temperature and humidity, relative pressure, wind chill, wind speed, rainfall and time and date.

The LCD will also display the history icon  history data records with the associated date and time.

5.17 Alerts

This feature alerts you in the event that defined parameters are out of range. Once the alert is met, the alarm will sound, and the parameter will flash.

5.17.1 Setting the Alerts

1. In normal mode, press the **ALERT** button on the back of the console to enter alert set mode.
2. During alert set mode, press the **ALERT** button to switch to the next parameter in the sequence below:

Command	Parameter	Set Range	Display Section	Default Value
[ALERT]	Outdoor temperature high alert	-40°C to 80°C (-40°F to 176°F)	Outdoor temperature & humidity (OUTDOOR)	40 °C (104 °F)
[ALERT]	Outdoor temperature low alert			0 °C (32 °F)
[ALERT]	Outdoor humidity high alert	1% to 99%		80%
[ALERT]	Outdoor humidity low alert			40%

[ALERT]	Indoor temperature high alert	-40°C to 80°C (-40°F to 176°F)	Indoor temperature & humidity (INDOOR)	40 °C (104 °F)
[ALERT]	Indoor temperature low alert			0 °C (32 °F)
[ALERT]	Indoor humidity high alert	1% to 99%		80%
[ALERT]	Indoor humidity low alert			40%
[ALERT]	Wind Speed	m/s to 50 m/s (0.22 mph to 112 mph)	Wind direction & speed section (WIND)	17.2 m/s (38.4 mph)
[ALERT]	Feels Like High Alert	-65°C to 50°C (-85°F to 122°F)	Feels Like, Dew Point and Wind Chill (INDEX)	20°C
[ALERT]	Feels Like Low Alert			0°C
[ALERT]	Dewpoint High Alert	-40°C to 80°C (-40°F to 176°F)		10°C
[ALERT]	Dewpoint Low Alert			-10°C
[ALERT]	Heat Index High Alert	26°C to 50°C (79°F to 122°F)		30°C
[ALERT]	Wind Chill Low Alert	-65°C to 18°C (-85°F to 64°F)		0°C
[ALERT]	UV Index High Alert	1 to 16	UV and Light Intensity (SUN)	10
[ALERT]	Light Intensity High Alert	0.01 to 200.0 Klux		100 klux
[ALERT]	Pressure Drop	1 hPa to 10 hPa (0.02 hPa to 0.2 hPa)	Barometer section (BARO)	3 hPa (0.08 inHg)
[ALERT]	Hourly Rainfall	1 mm to 1000 mm (0.04 in to 39.37 in)	Rainfall section (RAINFALL)	100 mm (3.93 in)
[ALERT]	Exit Alert setting mode			

[ALERT] means press the ALERT button

Figure 33

3. After selecting the alert parameter, press and hold the **ALERT** buttons for 2 seconds to adjust, and the alert value will flash.
4. Press the [**^**] or [**v**] to adjust the alert value up or down or press and hold the buttons to change rapidly.
5. Press **ALERT** button again (do not hold) to exit the alert set mode and then press the **ALERT** button to switch to the next parameter.

5.17.2 Activating an Alert

1. Select the parameter you want to alert per the previous Section 5.17.2 using the **ALERT** button.
2. Press the **ALARM** button to toggle the alarm on or off.

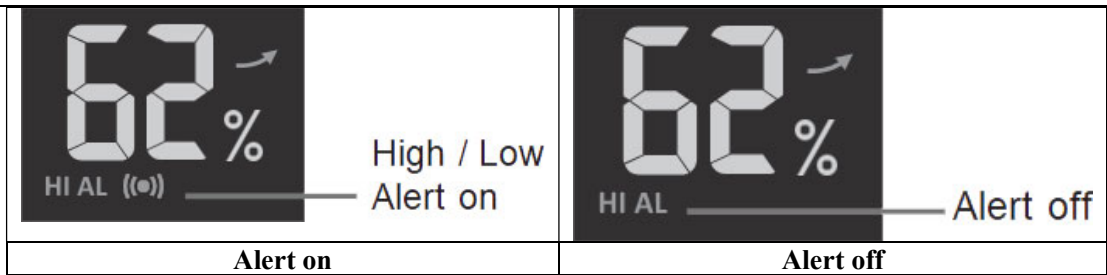

Figure 34

5.17.3 Silencing an Alert

Once an alert is triggered, the alarm will sound for two minutes, and the related alert icon will flash.

Press **ALARM / SNOOZE** button to silence the alert alarm and stop the icon from flashing, or the alarm will automatically turn off after two minutes.

5.17.4 Alert Duration

Once the alert is triggered, the alarm will sound for 2 minutes and the related alert icon and reading will flash. The alert icon and reading will flash until the weather reading is out of the alert range.

The weather alert will sound again when the weather reading falls within the alert range again.

5.18 Backlight

The **HI / LO / AUTO** slide switch provides the following brightness settings:

- **HI.** High intensity backlight
- **LO.** Low intensity backlight
- **AUTO.** Auto backlight according to ambient light level.

6. Connect your Console to Wi-Fi and the Internet

6.1 Register at Third Party Public Websites (optional):

WeatherCloud and WeatherUnderground.com are third party public websites and are another way to share your data.

Visit Wunderground.com, and select the **Join** link in the upper right and corner and create a Free Account. Once you create a free account, add a weather station.

Visit WeatherCloud.net and select Sign Up to create a free account and add a weather station.

6.2 Place Console in Access Point Mode

Place the console in Access Point mode by pressing and holding the Wi-Fi / Sensor button on the back of the display for 6 seconds, until **AP** is flashing in the time field:



Figure 35

6.3 Connect to the Console's Wi-Fi Server

Note: You may be required to disconnect your computer's ethernet cable from your router if it shares the same IP address 192.168.1.1.

- a) **Example 1: Connect to the console Wi-Fi server with a PC.** Choose Wi-Fi network settings from Windows (or search "Change Wi-Fi Settings" from Windows), and Connect to the PWS- Wi-Fi network, as shown in Figure 36 (your Wi-Fi network name may be slightly different, but will always begin with PWS-).

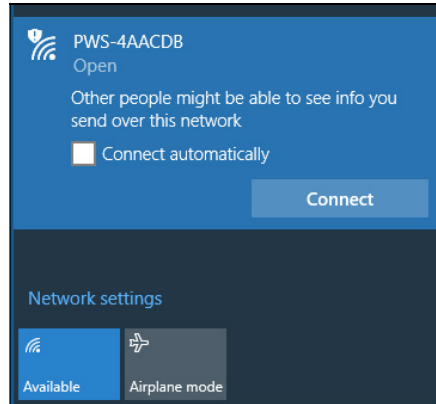



Figure 36

- b) **Example 2. Connect to the console Wi-Fi server with a Mac.** Choose the Settings icon  and Network . Connect to the PWS- Wi-Fi network, as shown in Figure 37 (your Wi-Fi network name may be slightly different, but will always begin with PWS-).

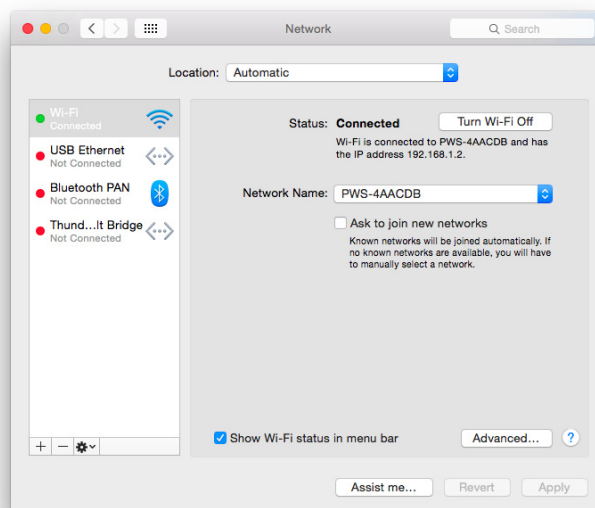



Figure 37

- c) **Example 3. Connect to the console Wi-Fi server with an iPhone or iPad.** Choose the

Settings icon  and Wi-Fi (Figure 38). Connect to the PWS- Wi-Fi network, as shown in Figure 39 (your Wi-Fi network name may be slightly different, but will always begin with PWS-).

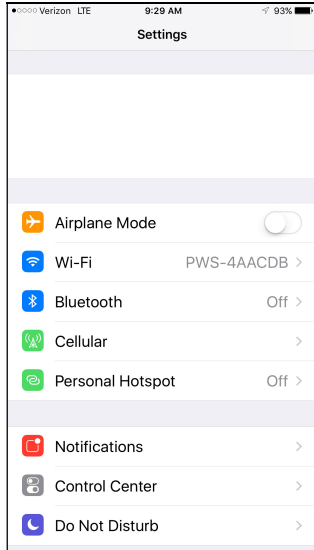

Figure 38

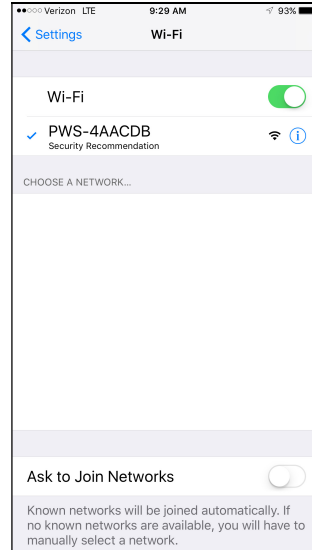



Figure 39

d) **Example 4. Connect to the console Wi-Fi server with an Android.** From the Apps

icon, choose the Settings icon  and Wi-Fi (Figure 40). Connect to the PWS- Wi-Fi network, as shown in Figure 41 (your Wi-Fi network name may be slightly different, but will always begin with PWS-).

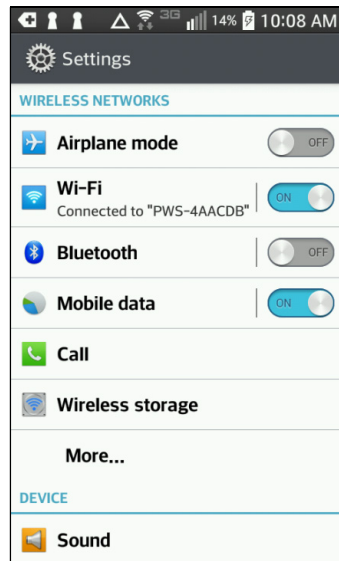

Figure 40

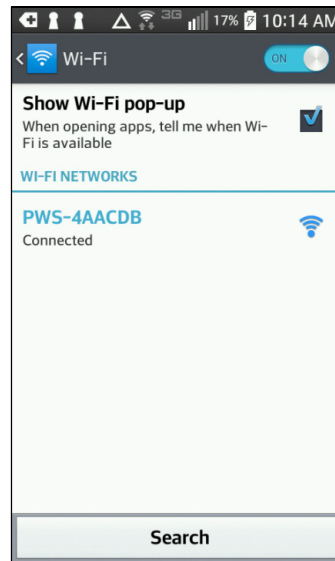

Figure 41

1. Once connected, enter the following IP address into any browser's address bar:

<http://192.168.1.1>

to access the console's web interface:

Note: Some browsers will treat 192.168.1.1 as a search, so make sure you include the header http://, or:

http://192.168.1.1 not 192.168.1.1

2. Enter the following information into the web interface (Figure 42). Make sure all of the information is entered prior to selecting Apply.

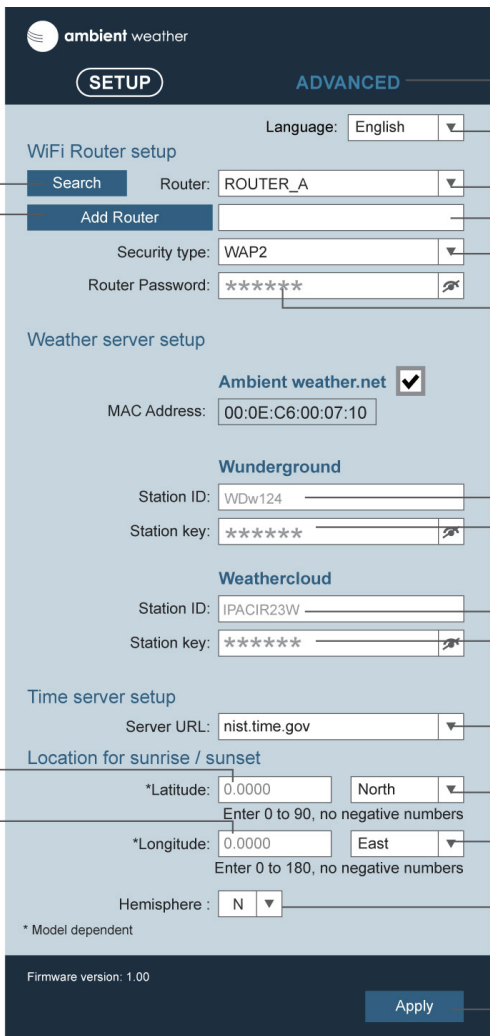

The screenshot shows the 'ADVANCED' setup page for ambient weather. It includes sections for WiFi Router setup, Weather server setup, Wunderground, Weathercloud, Time server setup, and Location for sunrise / sunset. Callouts provide instructions for each field, such as 'Press to search router', 'Select router (SSID) for connection', 'Enter new Station ID and Station key that assigned by Wunderground', and 'Select the direction (e.g. EU countries Longitude is East and US is West)'.

Figure 42

Notes:

- **Make a note of your Mac address.** You will need this to register at AmbientWeather.net.
- **Hidden SSIDs.** If you have a hidden SSID, enter the SSID manually.
- **Finding your Longitude and Latitude.** Visit Bing Maps:

<https://www.bing.com/mapspreview>

and enter your address.

In the example shown in Figure 43, the latitude is 38.898705 North, and the longitude is 77.036545 West (note that latitude is negative for the southern hemisphere and the longitude is negative for the western hemisphere. Do not enter the negative sign into the longitude field).

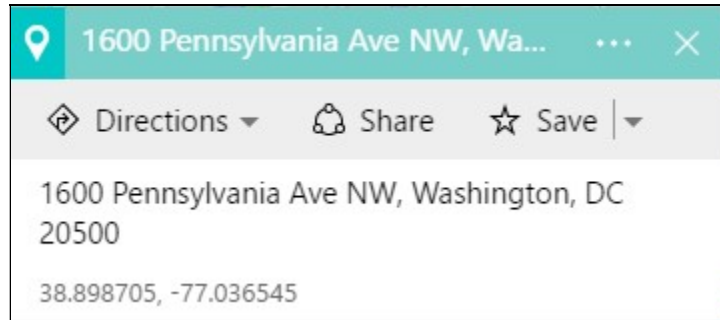



Figure 43

5. Once the setup is completed, the Wi-Fi console will disconnect from your computer or smart phone's Wi-Fi connection, and search for the assigned router. If the connection is successful, the Wi-Fi console's Wi-Fi icon  will remain on.

6.4 Register with AmbientWeather.net

Visit: www.AmbientWeather.net to create an account and select Add Device, as shown in Figure 44.

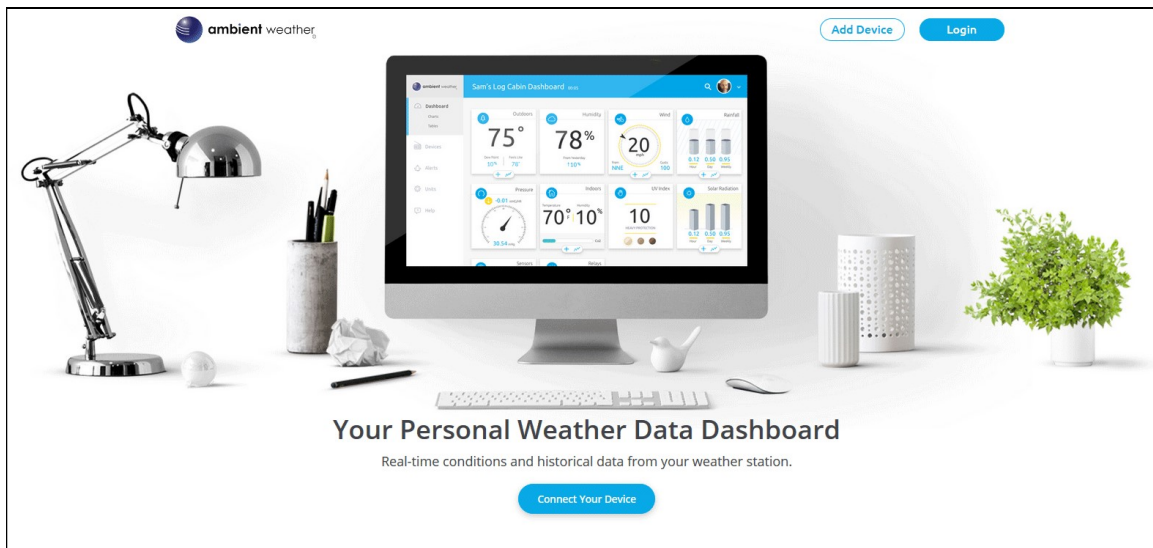

Figure 44

Next, enter the MAC address found on your Weather Station Web Interface (Figure 42). Note that this is an example only and your MAC address will be different.

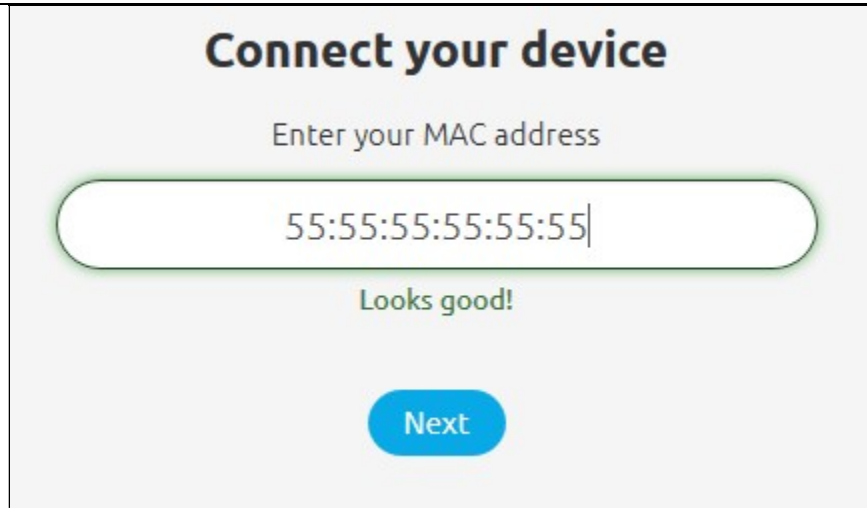

Figure 45

Register an account on AmbientWeather.net (email address and password).

Once registered, select the dashboard to view your data, as shown in Figure 46.

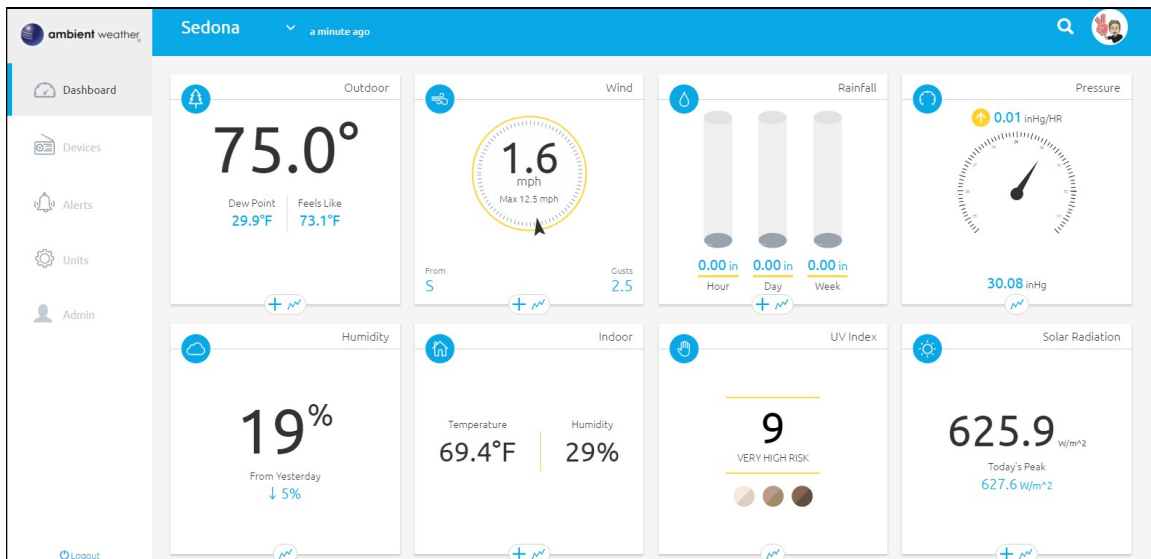

Figure 46

For a complete list of Ambient Weather apps, visit:

<https://ambientweather.net/help/community/>

6.5 Additional AmbientWeather.net Features

6.5.1 IFTTT

The AmbientWeather.net service connects to IFTTT, the platform that allows devices and services to work together seamlessly.

Here are a few things you can do with IFTTT:

- Turn off your Rachio sprinklers when it rains, there is too much wind, or below freezing.

- Close your Hunter blinds when the sun is too intense.
- Close your garage door when it is too windy.
- Blink your hue lights when it starts raining.
- Connect to other web services, such as Gmail, Facebook, Instagram, or Pinterest.

For more information on IFTTT and how it can work for you, visit:

https://ifttt.com/ambient_weather

6.5.2 Compatible with Alexa

The Ambient Weather skill provides Ambient Weather personal weather station owners with the ability to get real-time, and past weather information generated by the devices they have set up at AmbientWeather.net.

Enable the skill and get started: say "Alexa, ask Ambient Weather for a weather report.". This will provide you with your outdoor weather report, but you can ask for your indoor weather report as well by saying, "Alexa, ask Ambient Weather about the indoor conditions." You can also ask for a report about a specific day, month or year! Just say "Alexa, ask Ambient Weather about the weather yesterday." or "Alexa, ask Ambient Weather about the weather in May".

For more information and to enable this skill, visit:

<https://www.amazon.com/dp/B074PGCM1D/>

6.5.3 Works with Google Assistant

The Ambient Weather Google Assistant app provides Ambient Weather personal weather station owners with the ability to get real-time, and past weather information generated by the devices they have set up at AmbientWeather.net

Link your account to get started: say 'hey google, Ambient Weather... weather report.' This will provide you with your outdoor weather report. You can ask for your indoor weather report as well by saying, 'indoor conditions'.

You can also link the Ambient Weather app by downloading the Google Assistant.

Here are some sample commands:

- Weather Report
- Outdoor conditions
- Indoor conditions
- Yesterday's weather
- Conditions for October 15, 2017
- Conditions for September 2017
- Conditions for 2016

For more information and to enable this app, visit:

<https://assistant.google.com/services/a/id/668e6f3369f27209/>

6.6 Advanced Settings

To view advanced settings, from the Setup panel (Figure 32), tap the **ADVANCED** tab.

6.6.1 Calibration

Calibration is optional. The purpose of calibration is to fine tune or correct for any sensor error associated with the devices margin of error. Errors can occur due to electronic variation (example, the temperature sensor is a resistive thermal device or RTD, the humidity sensor is a capacitance device), mechanical variation, or degradation (wearing of moving parts, contamination of sensors).

Calibration is only useful if you have a known calibrated source you can compare it against and is optional. This section discusses practices, procedures and sources for sensor calibration to reduce manufacturing and degradation errors. Do not compare your readings obtained from sources such as the internet, radio, television or newspapers. The purpose of your weather station is to measure conditions of your surroundings, which vary significantly from location to location.

Note: The indoor temperature and humidity sensor is housed inside the display console. Channel 1-7 sensors are optional.

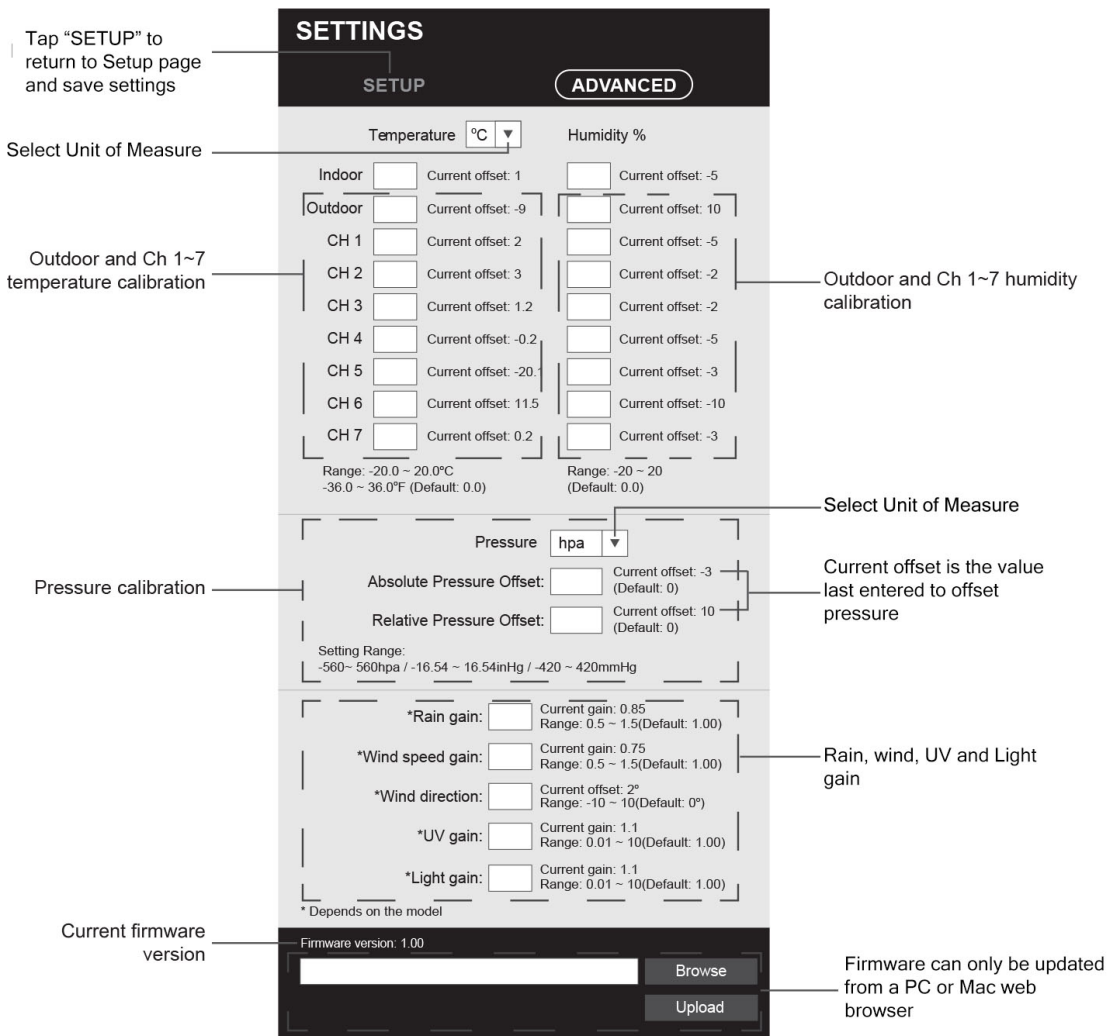

Figure 47

6.6.2 Notes About Calibration

Parameter	Type of Calibration	Default	Typical Calibration Source
Temperature	Offset	Current Value	Red Spirit or Mercury Thermometer (1)
Humidity	Offset	Current Value	Sling Psychrometer (2)
ABS Barometer	Offset	Current Value	Calibrated laboratory grade barometer
REL Barometer	Offset	Current Value	Local airport (3)
Wind Direction	Offset	Current Value	GPS, Compass (4)
Light Intensity	Gain	1.00	Calibrated laboratory grade solar radiation sensor
Wind	Gain	1.00	Calibrated laboratory grade wind meter (6)
Rain	Gain	1.00	Sight glass rain gauge with an aperture of at least 4" (7)

- (1) Temperature errors can occur when a sensor is placed too close to a heat source (such as a building structure, the ground or trees).

To calibrate temperature, we recommend a mercury or red spirit (fluid) thermometer. Bi-metal (dial) and digital thermometers (from other weather stations) are not a good source and have their own margin of error. Using a local weather station in your area is also a poor source due to changes in location, timing (airport weather stations are only updated once per hour) and possible calibration errors (many official weather stations are not properly installed and calibrated).

Place the sensor in a shaded, controlled environment next to the fluid thermometer, and allow the sensor to stabilize for 48 hours. Compare this temperature to the fluid thermometer and adjust the tablet to match the fluid thermometer.

- (2) Humidity drifts over time due to contamination. In addition, location has an adverse effect on humidity readings (installation over dirt vs. lawn for example).

Official stations recalibrate or replace humidity sensors on a yearly basis. Due to manufacturing tolerances, the humidity is accurate to $\pm 5\%$. To improve this accuracy, the indoor and outdoor humidity can be calibrated using an accurate source, such as a sling psychrometer.

- (3) The tablet displays two different pressures: absolute (measured) and relative (corrected to sea-level).

To compare pressure conditions from one location to another, meteorologists' correct pressure to sea-level conditions. Because the air pressure decreases as you rise in altitude, the sea-level corrected pressure (the pressure your location would be at if located at sea-level) is generally higher than your measured pressure.

Thus, your absolute pressure may read 28.62 inHg (969 mb) at an altitude of 1000 feet (305 m), but the relative pressure is 30.00 inHg (1016 mb).

The standard sea-level pressure is 29.92 in Hg (1013 mb). This is the average sea-level pressure around the world. Relative pressure measurements greater than 29.92 inHg (1013

mb) are considered high pressure and relative pressure measurements less than 29.92 inHg are considered low pressure.

To determine the relative pressure for your location, locate an official reporting station near you (the internet is the best source for real time barometer conditions, such as Weather.com or Wunderground.com), and set your weather station to match the official reporting station.

- (4) Only use this if you improperly installed the weather station sensor array and did not point the direction reference to true north.
- (5) The default conversion factor based on the wavelength for bright sunlight is 126.7 lux / w/m². This variable can be adjusted by photovoltaic experts based on the light wavelength of interest, but for most weather station owners, is accurate for typical applications, such as calculating evapotranspiration and solar panel efficiency.
- (6) Wind speed is the most sensitive to installation constraints. The rule of thumb for properly installing a wind speed sensor is 4 x the distance of the tallest obstruction. For example, if your house is 20' tall and you mount the sensor on a 5' pole:

$$\text{Distance} = 4 \times (20 - 5)' = 60'.$$

Many installations are not perfect and installing the weather station on a roof can be difficult. Thus, you can calibrate for this error with a wind speed multiplier.

In addition to the installation challenges, wind cup bearings (moving parts) wear over time.

Without a calibrated source, wind speed can be difficult to measure. We recommend using a calibrated wind meter (available from Ambient Weather) and a constant speed, high speed fan.

- (7) The rain collector is calibrated at the factory based on the funnel diameter. The bucket tips every 0.01" of rain (referred to as resolution). The accumulated rainfall can be compared to a sight glass rain gauge with an aperture of at least 4". The following is a link to an accurate sight glass rain gauge:

<http://www.ambientweather.com/stpraga.html>

Make sure you periodically clean the rain gauge funnel.

6.6.3 Calibrating the Wind Direction for the Southern Hemisphere

The solar collector is designed to face south for customers in the Northern Hemisphere. If you live in the Southern Hemisphere, you will need to point the solar connector to the North and select Hemisphere: S from the setup page shown in Figure 42.

Note: Changing the hemisphere setting will automatically switch the direction of the moon phase on the display.

6.6.4 Firmware Updates

To download the latest version of firmware to your computer, visit:

<https://help.ambientweather.net/product/ws-7079>

To update the firmware, browse to the firmware file saved on your computer and tap **Upload** (Figure

47).

From the Setup panel (Figure 32), tap the **ADVANCED** tab to update the firmware.

The upload takes approximately 5-10 minutes. While updating, the status will be displayed in the wind direction field.



Figure 48

7 Maintenance

REPLACE THE WIND CUP

1. Remove rubber cap and Unscrew
2. Remove the wind cup for replacement

CLEANING THE UV SENSOR AND CALIBRATION

- For precision UV measurement, gently clean the UV sensor cover lens with damp micro-fiber cloth.
- Over time, the UV sensor will naturally degrade. The UV sensor can be calibrated with a utility grade UV meter, please refer to Calibration section in previous page for about the UV sensor calibration.

REPLACE THE WIND VANE

- Unscrew and remove the wind vane for replacement

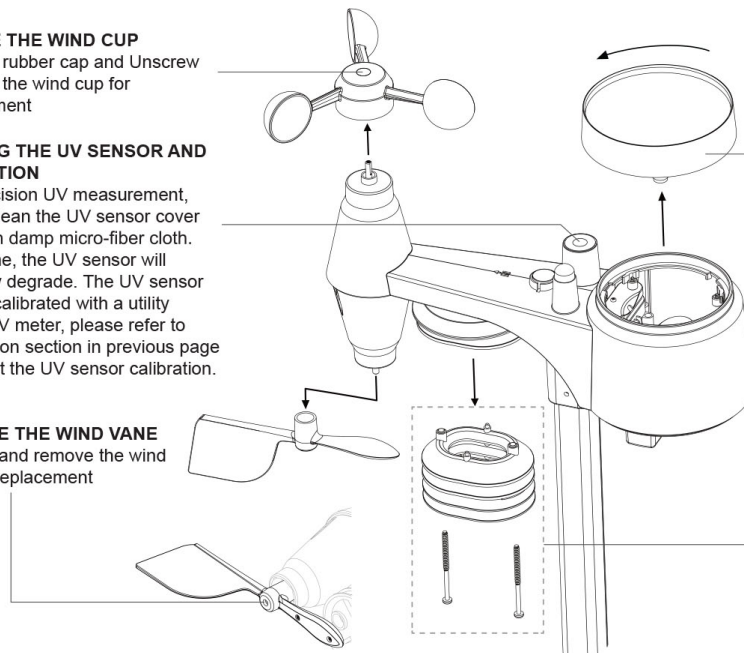

Figure 49

CLEANING THE RAIN COLLECTOR

1. Rotate the rain collector by turning it 30° anti-clockwise.
2. Gently remove the rain collector.
3. Clean and remove any debris or insects.
4. Install the collector when it is clean and fully dried.

CLEANING HYGRO-THERMO SENSOR

1. Remove the 2 screws at the bottom of the radiation shield.
2. Gently pull out the bottom 4 shields.
3. Carefully remove any dirt or insects on the sensor and ventilation fan (do not let the sensors inside get wet).
4. Clean the shield with water to remove any dirt or insects.
5. Install all the parts back when they are clean and fully dried.

8 Battery Replacement

When the low battery indicator  is displayed, it indicates that the outdoor sensor array, console, or the current channel sensor battery power is low, and the batteries need replacing.

To replace the display console battery, reference Figure 50.

Step 1	Step 2	Step 3
		
Remove the console battery door with coin	Insert a new button cell battery	Replace the battery door.

Figure 50

9 Adding or Subtracting Multiple Sensors

If you add or subtract multiple sensors, you will need to synchronize the sensors.

9.1 Adding or Subtracting Sensors

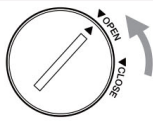
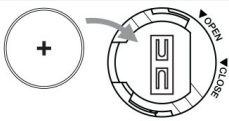
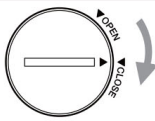
1. Make sure each sensor is on a different channel and in sequence (1, 2, 3, ...) before powering up. Insert the batteries.
If already powered up, press the reset button inside the battery compartment. Reference Figure 1 for details.
2. Place each sensor about 5 to 10 feet from the console.
3. Press the **SENSOR** button on the back of the console to begin synchronization. Reference Section 3.4.1 for details.
4. Do not touch any buttons until synchronization is complete.

9.2 Optional Sensors

The following optional sensors are available. You can mix and match up to seven sensors:



Item Number	Description	Image
TX-3110B	Indoor / Outdoor Thermo-Hygrometer	
TX-3102	Soil Temperature / Moisture	
TX-3107	Floating Pool and Spa Thermometer	

Figure 51

9.3 Assigning Optional Sensor Channels

The WS-7079 supports up to 7 optional sensors. To set the channel dip switch, reference Figure 2.

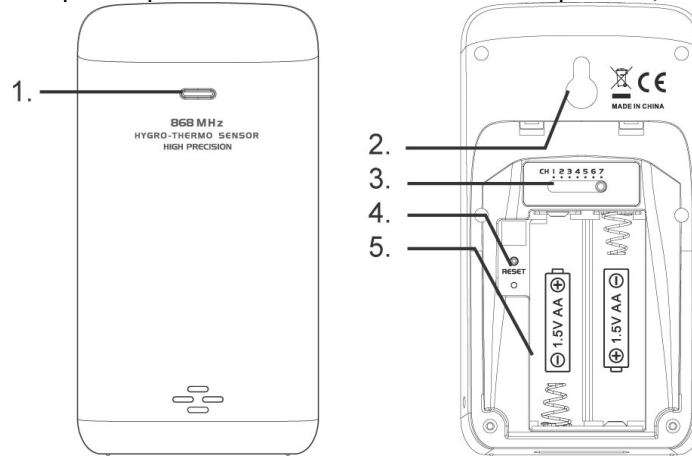

Figure 52

No	Description	No	Description
1	Transmitter LED (flashes when the remote is transmitting)	4	[RESET] button
2	Suspension eye for hanging	5	2 x AA battery compartment
3	Transmitter channel (assign the transmitter to 1, 2 ,3 ,4, 5, 6, or 7 default = 1)		

10 Specifications

10.1 Wireless Specifications

- Outdoor Sensor Array: 300 feet line of sight, 100 feet under most conditions.
- Frequency: 915 MHz
- Update Rate: Wind Speed and Direction: 12 seconds. All other outdoor parameters: 24 seconds, indoor parameters: 60 seconds

10.2 Measurement Specifications

The following table provides specifications for the measured parameters.

Measurement	Range	Accuracy	Resolution
Indoor and Outdoor Temperature	-4 to 140 °F alkaline batteries -40 to 140 °F Lithium e2 Energizer batteries	131 to 140°F: ± 0.9°F (55 to 60°C: ± 0.5°C) 50 to 131°F: ± 0.7°F (10 to 55°C: ± 0.4°C) - 4 to 50°F: ± 2.3°F (-20 to 10°C: ± 1.3°C) - 40 to - 4°F: ± 3.4°F (-40 to -20°C: ± 1.9°C)	0.1 °F/°C
Indoor and Outdoor Humidity	0 to 99%	1 to 20% RH ± 6.5% RH @ 25°C (77°F) 21 to 80% RH ± 3.5% RH @ 25°C (77°F) 81 to 99% RH ± 6.5% RH @ 25°C (77°F)	1%
Barometer	Altitude Range: -2288 to 16,416 feet (-697 to 5000 meters) Barometer Range: 15.94 to 32.48 inHg (540hPa to 1100hPa)	20.67 to 32.48 inHg: ±0.15inHg (700 to 1100hPa: ± 5hPa) 15.94 to 20.67 inHg: ± 0.24inHg (540 to 700hPa: ± 8hPa) typical at 77°F (25°C)	1hPa / 0.01inHg / 0.1mmHg
Wind Speed	0 to 112mph (50m/s, 180km/h, 97knots)	< 11 mph (5m/s): +/- 1.1 mph (0.5m/s) > 11 mph (5m/s): +/- 6% of point	0.1mph, 0.1m/s, 0.1km/h, 0.1knots
Wind Direction	0 to 360°	± 3°	1°
Rain	0 to 787.3 in (0 to 19999mm)	± 7%	0.01 in (0.254 mm)
UV	0 to 16	±1 UVI	1
Light Intensity	0 to 200 klux	± 30%	0.01 klux

10.3 Power Consumption

- Display backup power: 1 x CR2032 battery (included)
- Display: DC 5V, 1.0A 100-240V 50 / 60 Hz UL rated Class 5 adaptor
- Outdoor Sensor Array: 3 x AA Alkaline batteries recommended, Lithium e2 Energizer for cold weather.

10.4 Wi-Fi Specifications

- WIFI Standard: 802.11 b/g/n

- Wi-Fi Operating frequency: 2.4G
- Setup User Interface (UI) support setup device: Build-in Wi-Fi with WAP mode smart device, including laptops, computers, smart phones and smart pads.
- Recommend web browser for setup UI: Web browser support of HTML 5, such as the latest versions of Chrome, Safari, IE, Edge, Firefox or Opera.

10.5 Other Specifications

- Time synchronize method: Synchronized through internet UTC time server
- Console Temperature Limits of Operation: 23 °F to 122 °F (-5°C to 50°C)

10.6 Weight Specifications

- Console: 1.0 lbs. (460 grams) with batteries
- Sensor Array: 1.6 lbs. (722 grams) with batteries

11 Troubleshooting Guide

If your question is not answered here, you can contact us as follows:

1. Email Support: support@ambientweather.com
2. Technical Support: 480-346-3380 (M-F 8am to 3pm Arizona Time). Note that Arizona does not observe Daylight Savings Time.
3. Visit our help guide: <https://help.ambientweather.net/product/ws-7079>

Problem	Solution
The wireless sensor communication has been lost or is intermittent or will not sync up.	<ul style="list-style-type: none"> • Make sure the transmitter is powered up and the LED is flashing about once per 12 seconds. For cold weather environments, install lithium batteries. If the transmitter is not flashing, replace the batteries. • Resync the console. Reference Section 3.5.2. • The maximum line of sight communication range is 300'. Move the sensor closer to the console. • If the sensor array is too close (less than 5-10'), move the sensor away from the console. • Make sure the remote sensors are not transmitting through solid metal (acts as an RF shield), or earth barrier (down a hill). • Move the console away from electrical noise generating devices, such as computers, TVs and other wireless transmitters or receivers. • Radio Frequency (RF) Sensors cannot transmit through metal barriers (example, aluminum siding) or multiple, thick walls.
The console does not respond to commands.	<ul style="list-style-type: none"> • Press the reset button on the back of the console with an open-ended paper clip or sharp tool.
Cannot connect the console to Wi-Fi	<ul style="list-style-type: none"> • Check your Wi-Fi password is correct. • Make sure your device (desktop, laptop, tablet or phone) is connected to your Wi-Fi router. • If you own a dual band router (2.4 and 5 GHz), make sure your Wi-Fi 2.4 GHz band is turned on.
AmbientWeather.net is not updating	<ul style="list-style-type: none"> • Make sure your MAC address was entered correctly. • Make sure the checkbox is checked in the web panel (reference Figure 42).
Wunderground.com is not updating	<ul style="list-style-type: none"> • Make sure the checkbox is checked in the web panel (reference Figure 42). • Make sure your station ID and Station Key are correct (reference Figure 44). • DO NOT copy and paste your station key into the console's web display, as it will add a lagging space. Make sure you type it in. Also, it is easy to confuse the lower-case letter l, upper case I and the number 1, as well as the number 0 and the letter O.

Problem	Solution
Console Sunrise and Sunset is not correct	Make sure your longitude, latitude (reference Figure 42), time zone and Daylight Savings Time are set properly (Reference Section 5.1.1).
Console Time is off by increments of hours.	Make sure your time zone and Daylight Savings Time are set properly (Reference Section 5.1.1).

12 Liability Disclaimer

Please help in the preservation of the environment and return used batteries to an authorized depot. The electrical and electronic wastes contain hazardous substances. Disposal of electronic waste in wild country and/or in unauthorized grounds strongly damages the environment.

Reading the “User manual” is highly recommended. The manufacturer and supplier cannot accept any responsibility for any incorrect readings and any consequences that occur should an inaccurate reading take place.

This product is designed for use in the home only as indication of weather conditions. This product is not to be used for medical purposes or for public information.

The specifications of this product may change without prior notice.

This product is not a toy. Keep out of the reach of children.

No part of this manual may be reproduced without written authorization of the manufacturer.

Ambient, LLC WILL NOT ASSUME LIABILITY FOR INCIDENTAL, CONSEQUENTIAL, PUNITIVE, OR OTHER SIMILAR DAMAGES ASSOCIATED WITH THE OPERATION OR MALFUNCTION OF THIS PRODUCT.

13 FCC Statement

Statement according to FCC part 15.19:

This device complies with part 15 of the FCC rules. Operation is subject to the following two conditions:

1. This device may not cause harmful interference.
2. This device must accept any interference received, including interference that may cause undesired operation.

Statement according to FCC part 15.21:

Modifications not expressly approved by this company could void the user's authority to operate the equipment.

Statement according to FCC part 15.105:

NOTE: This equipment has been tested and found to comply with the limits for a Class B digital device, pursuant to Part 15 of the FCC Rules. These limits are designed to provide reasonable protection against harmful interference in a residential installation. This equipment generates, uses and can radiate radio frequency energy and, if not installed and used in accordance with the instructions, may cause harmful interference to radio communications.

However, there is no guarantee that interference will not occur in a particular installation. If this equipment does cause harmful interference to radio or television reception, which can be determined by turning the equipment off and on, the user is encouraged to try to correct the interference by one or more of the following measures:

- Reorient or relocate the receiving antenna.

- Increase the separation between the equipment and receiver.
- Connect the equipment into an outlet on a circuit different from that to which the receiver is connected.
- Consult the dealer or an experienced radio/TV technician for help.

The Responsible party:

Company Name: Ambient, LLC

Address: 6845 W. Frye Road Chandler, AZ 85226

Phone: 1-(480)346-3380

14 Warranty Information

Ambient, LLC provides a 1-year limited warranty on this product against manufacturing defects in materials and workmanship.

This limited warranty begins on the original date of purchase, is valid only on products purchased and only to the original purchaser of this product. To receive warranty service, the purchaser must contact Ambient, LLC for problem determination and service procedures.

Warranty service can only be performed by an Ambient, LLC. The original dated bill of sale must be presented upon request as proof of purchase to Ambient, LLC.

Your Ambient, LLC warranty covers all defects in material and workmanship with the following specified exceptions: (1) damage caused by accident, unreasonable use or neglect (lack of reasonable and necessary maintenance); (2) damage resulting from failure to follow instructions contained in your owner's manual; (3) damage resulting from the performance of repairs or alterations by someone other than an authorized Ambient, LLC authorized service center; (4) units used for other than home use (5) applications and uses that this product was not intended (6) the products inability to receive a signal due to any source of interference or metal obstructions and (7) extreme acts of nature, such as lightning strikes or floods.

This warranty covers only actual defects within the product itself and does not cover the cost of installation or removal from a fixed installation, normal set-up or adjustments, claims based on misrepresentation by the seller or performance variations resulting from installation-related circumstances.

15 California Prop 65

WARNING: Use of the Ambient Weather Products can expose you to chemicals, including lead and lead compounds, which are known to the State of California to cause cancer and bisphenol A (BPA), and phthalates DINP and/or DEHP, which are known to the State of California to cause birth defects or other reproductive harm.

Can I Trust that Ambient Weather Products are Safe Despite this Warning?

In 1986, California voters approved the Safe Drinking Water and Toxic Enforcement Act known as Proposition 65 or Prop 65. The purpose of Proposition 65 is to ensure that people are informed about exposure to chemicals known by the State of California to cause cancer, birth defects and/or other reproductive harm. A company with ten or more employees that operates within the State of California (or sells products in California) must comply with the requirements of Proposition 65. To comply, businesses are: (1) prohibited from knowingly discharging listed chemicals into sources of drinking water; and (2) required to provide a "clear and reasonable" warning before knowingly and

intentionally exposing anyone to a listed chemical. Proposition 65 mandates that the Governor of California maintain and publish a list of chemicals that are known to cause cancer, birth defects and/or other reproductive harm. The [Prop 65 list](#), which must be updated annually, includes over 1,000 chemicals, including many that are commonly used in the electronics industry.

Although our manufacturing process is "lead-free" and RoHS compliant, it remains possible that trace amounts of lead could be found in components or subassemblies of Ambient Weather Products. Bisphenol A (BPSA) could conceivably be present in minute amounts in our plastic housings, lenses, labels or adhesives, and DEHP & DINP (phthalates) could possibly be found in PVC wire coatings of our cables, housings, and power cords. Unlike RoHS, Prop 65 does not establish a specific threshold for reporting on the substances of concern and instead sets forth a much less definitive standard requiring that the business demonstrate with certainty that there is "no significant risk" resulting from exposure. With respect to carcinogens, the "no significant risk" level is defined as the level which is calculated to result in not more than one excess case of cancer in 100,000 individuals exposed over a 70-year lifetime. In other words, if you are exposed to the chemical in question at this level every day for 70 years, theoretically, it will increase your chances of getting cancer by no more than 1 case in 100,000 individuals so exposed. With respect to reproductive toxicants, the "no significant risk" level is defined as the level of exposure which, even if multiplied by 1,000, will not produce birth defects or other reproductive harm. In other words, the level of exposure is below the "no observable effect level," divided by 1,000. (The "no observable effect level" is the highest dose level which has not been associated with observable reproductive harm in humans or test animals.) Proposition 65 does not clarify whether exposure is to be measured only in normal operation, or in the event of misuse such as intentionally damaging, incinerating or consuming an Ambient Weather Product or component and Ambient Weather has not attempted to evaluate the level of exposure.

A Proposition 65 warning means one of two things: (1) the business has evaluated the exposure and has concluded that it exceeds the "no significant risk level"; or (2) the business has chosen to provide a warning simply based on its knowledge about the presence of a listed chemical without attempting to evaluate the exposure. The California government has itself clarified that "The fact that a product bears a Proposition 65 warning does not mean by itself that the product is unsafe." The government has also explained, "You could think of Proposition 65 more as a 'right to know' law than a pure product safety law."

While using Ambient Weather Products as intended, we believe any potential exposure would be negligible or well within the "no significant risk" range. However, to ensure compliance with California law and our customers' right to know, we have elected to place the Proposition 65 warning signs on Ambient Weather Products.

For further information about California's Proposition 65, please visit <https://oehha.ca.gov/prop65/background/p65plain.html>

