

---

# Ambient Weather WS-8478A FALCON Solar Powered Wireless WiFi Remote Monitoring Weather Station User Manual



## Table of Contents

1.	Introduction .....	3
1.1	Model History and Changes .....	3
2.	Warnings .....	4
3.	Getting Started .....	4
3.1	Parts List.....	4
3.2	Quick Start Guide .....	4
3.3	Product Features .....	5
3.3.1	Display .....	5
3.3.2	Wireless Indoor Thermo-Hygrometer Transmitter .....	6
3.3.3	Sensor Array.....	7
3.4	Powering Up.....	8
3.4.1	Power Up Sequence .....	8
3.4.2	Initial Sensor Synchronization .....	9
3.5	Mount the Indoor Sensor.....	9
3.6	Mount the Outdoor Sensor Array .....	9
3.6.1	Site Survey .....	9
3.6.2	Pole Mounting the Sensor Array .....	10
4.	Console Display .....	11
5.	Settings.....	11
5.1	Time Settings.....	11
5.1.1	Time Zone Settings .....	13
5.2	Month Day vs. Year Display .....	14
5.3	Moon Phase .....	14
5.4	Sunrise and Sunset .....	15
5.5	WiFi Connection Status.....	15
5.6	Time Server Sync Status.....	15
5.7	Alarm Settings.....	16
5.7.1	Turning On and Off the Alarm Feature .....	16
5.7.2	Setting the Alarm Time .....	16
5.7.3	Using the Alarm and Snooze Functions .....	16
5.8	Temperature and Humidity Display and Settings .....	17
5.8.1	Temperature Units of Measure .....	17
5.8.2	Outdoor Sensor Array Signal Strength.....	17
5.8.3	Indoor Sensor .....	17
5.8.4	Temperature and Humidity Trend .....	18
5.8.5	Temperature and Humidity Measurements Limits .....	18
5.9	Wind .....	18
5.9.1	Average Wind Speed vs. Wind Gust .....	19
5.9.2	Wind Units of Measure and Wind Direction Format .....	19
5.9.3	Wind Speed Level .....	19
5.9.4	Calibrating the Wind Direction for the Southern Hemisphere .....	19

5.10	Barometric Pressure Display and Settings .....	20
5.10.1	Barometric Pressure Units of Measure .....	20
5.10.2	Absolute Pressure vs. Relative Pressure .....	20
5.10.3	Relative Pressure Calibration.....	20
5.11	The Forecast.....	21
5.12	Weather Index.....	21
5.12.1	UV Index.....	22
5.12.2	Beaufort Scale.....	22
5.12.3	Wind Chill.....	24
5.12.4	Heat Index.....	24
5.12.5	Dew Point.....	25
5.13	Rainfall.....	26
5.13.1	Rain Units of Measure .....	26
5.13.3	Rain Increments of Measure .....	26
5.13.3	Resetting Rain to Zero .....	27
5.14	Graph.....	27
5.15	Min / Max.....	28
5.16	History Data (Past 24 hours) .....	29
5.17	Alerts .....	29
5.17.1	Setting the Alerts.....	29
5.17.2	Activating an Alert.....	30
5.17.3	Silencing an Alert.....	30
6	WiFi Connection and Weather Servers .....	30
6.1	Register at Wunderground.com (Weather Underground) .....	30
6.2	WiFi Setup.....	31
6.3	Register with AmbientWeather.net.....	36
6.4	Viewing your Data on Weather Underground .....	37
6.4.1	Web Browser .....	38
6.4.2	WunderStation iPad Application .....	38
6.4.3	Mobile Apps.....	39
6.5	Additional AmbientWeather.net Features .....	40
6.5.1	IFTTT .....	40
6.5.2	Compatible with Alexa.....	40
6.5.3	Works with Google Assistant .....	41
7	Maintenance.....	41
7.1	Battery Replacement .....	41
7.2	Cleaning the Rain Collector .....	41
7.3	Cleaning the Outdoor Thermo-Hygrometer Sensor .....	42
7.4	UV Sensor Calibration and Cleaning .....	43
7.4.1	Sensor Manufacturing Gain .....	43
7.4.2	UV Sensor Degradation .....	44
7.5	Console Firmware Updates .....	44
8	Adding or Subtracting Multiple Sensors.....	45
8.1	Adding or Subtracting Sensors.....	45
8.2	Multiple Sensor Features .....	46
9	Specifications.....	46
9.1	Wireless Specifications .....	46
9.2	Measurement Specifications.....	47
9.3	Power Consumption .....	47
9.4	WiFi Specifications .....	47
9.5	Other Specifications .....	48
9.6	Weight Specifications.....	48
10	Troubleshooting Guide .....	48

11	Liability Disclaimer.....	50
12	FCC Statement.....	50
13	Warranty Information .....	51

## 1. Introduction

Thank you for your purchase of the Ambient Weather WS-8478A FALCON Solar Powered Wireless WiFi Remote Monitoring Weather Station.

The following user guide provides step by step instructions for installation, operation and troubleshooting. To download the latest full sized manual and additional troubleshooting tips, please visit:

<https://ambientweather.net/help/>

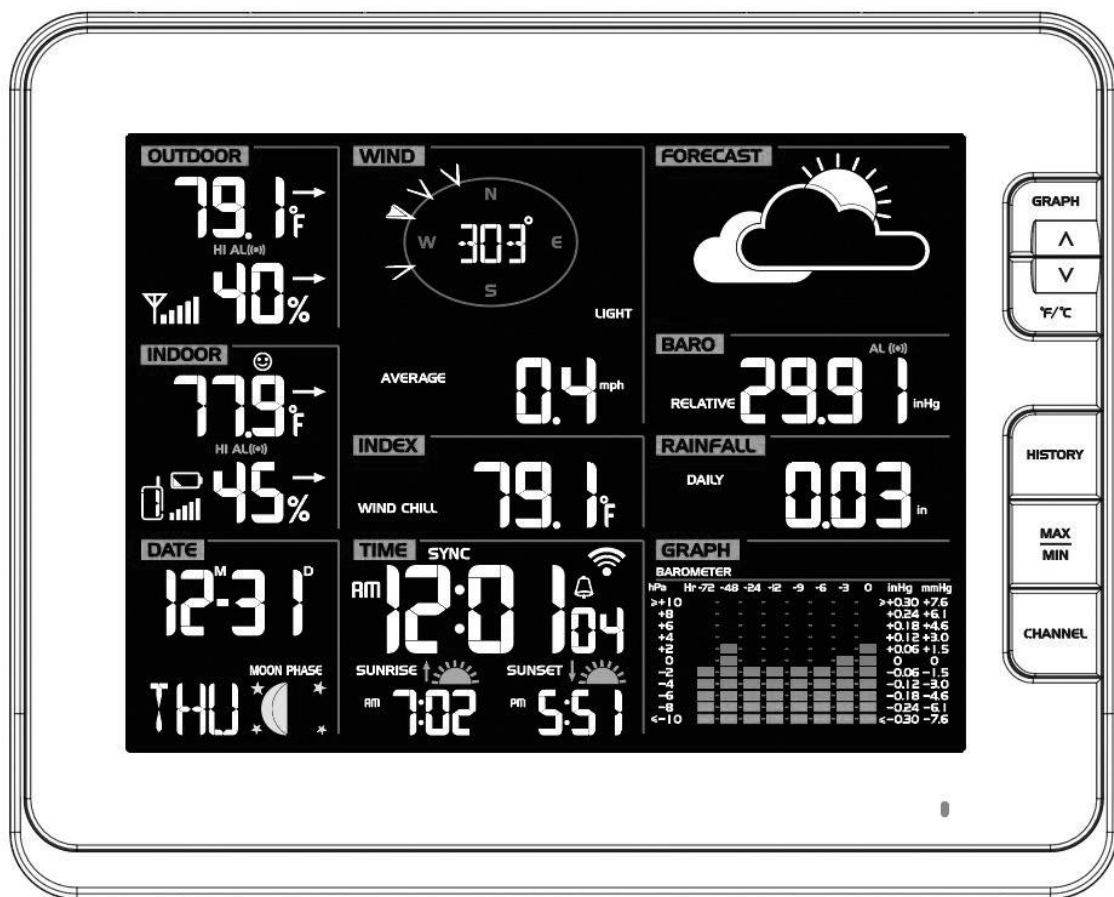


Figure 1

### 1.1 Model History and Changes

The WS-8478 supports the following 7 channel sensor:

- TX-3110B Wireless Thermo-Hygrometer

The WS-8478A supports the following 7-channel sensors:

- TX-3110B Wireless Thermo-Hygrometer
- TX-3107 Floating Pool and Spa Thermometer
- TX-3102 Soil Moisture and Thermometer

## 2. Warnings

- ⚠ **Warning.** Only use the included approved AC adapter.
- ⚠ **Warning:** Any metal object may attract a lightning strike, including your weather station mounting pole. Never install the weather station in a storm.
- ⚠ **Warning:** Installing your weather station in a high location may result in injury or death. Perform as much of the initial check out and operation on the ground and inside a building or home. Only install the weather station on a clear, dry day.

## 3. Getting Started

Note: Remove the plastic film from the console face before getting started.

### 3.1 Parts List

QTY	Item
1	Display Console Frame Dimensions (L x W x H): 8.5 x 6.8 x 1.1 in
1	Wireless Indoor Thermo-Hygrometer (L x W x H): 4.5 x 2.5 x 1.5"
1	Wireless Outdoor Sensor Array (L x W x H): 15.4 x 12.8 x 5.7"
1	UL Rated Class 5 AC Adapter
1	User Manual

### 3.2 Quick Start Guide

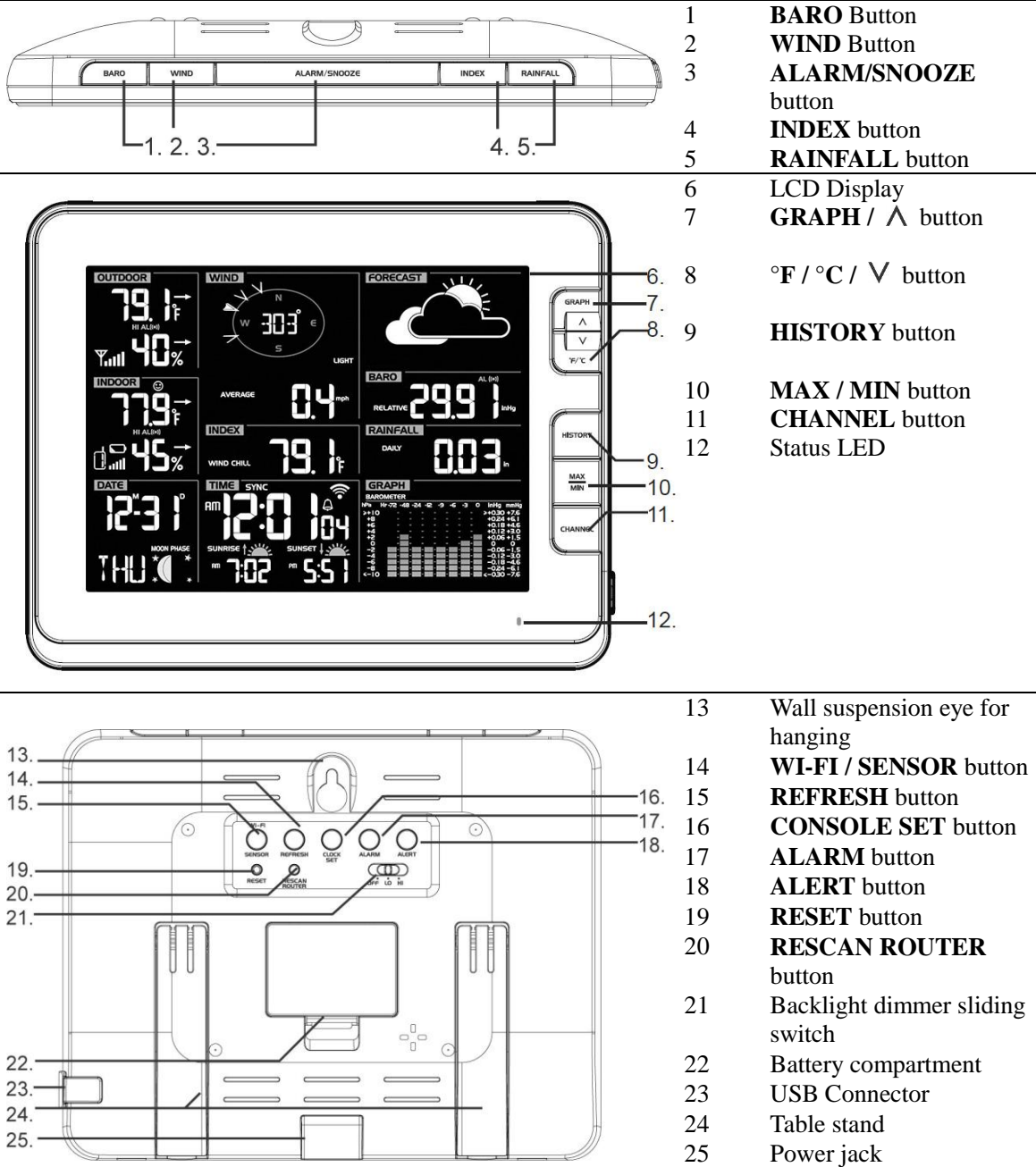
Although the manual is comprehensive, much of the information contained may be intuitive. In addition, the manual does not flow properly because the sections are organized by components.

The following Quick Start Guide provides only the necessary steps to install, operate the weather station, and upload to the internet, along with references to the pertinent sections.

✓	Step	Description	Section
	1	Assemble and power up the sensor array	3.4
	2	Power up the indoor thermometer-hygrometer	3.4
	3	Power up the display console and synchronize with sensor array and thermo-hygrometer	3.4
	4	Mount the indoor sensor	3.5
	5	Mount the sensor array	3.6
	6	Set console settings	5
	7	Calibrate the relative pressure to sea-level conditions (local airport) on console	5.10.3
	8	Reset the rain to zero on console (due to movement during installation)	5.13.3
	9	Register at Wunderground.com	6.1
	10	Configure WiFi, Server Settings, and Location	6.2
	11	Register at AmbientWeather.net	6.3

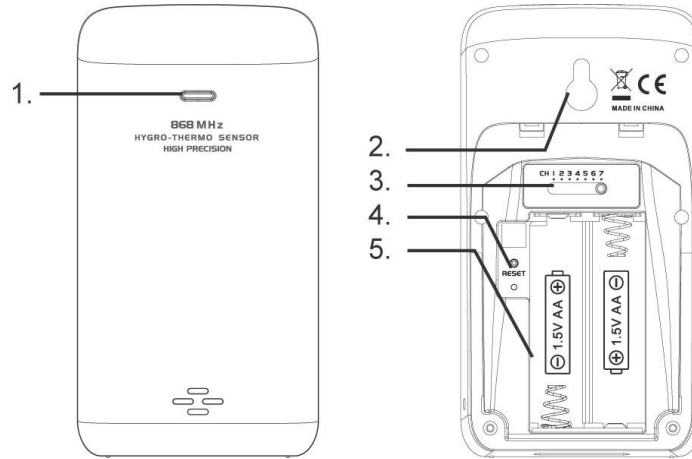
### 3.3 Product Features

#### 3.3.1 Display



**Figure 2**

### 3.3.2 Wireless Indoor Thermo-Hygrometer Transmitter

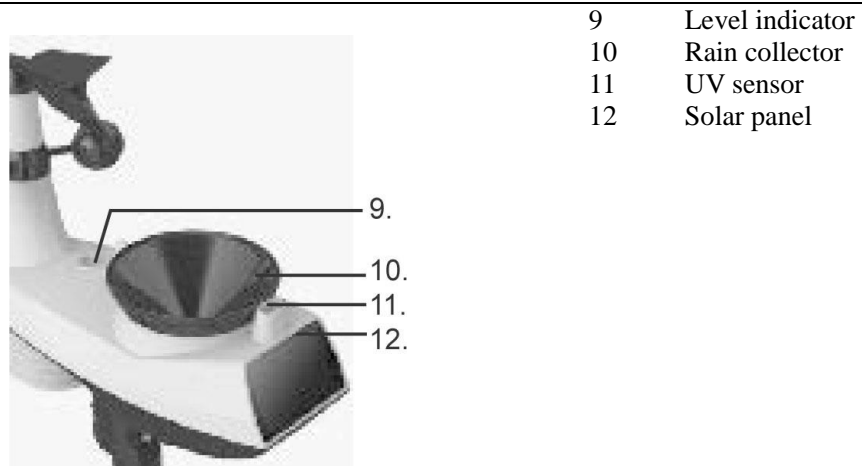
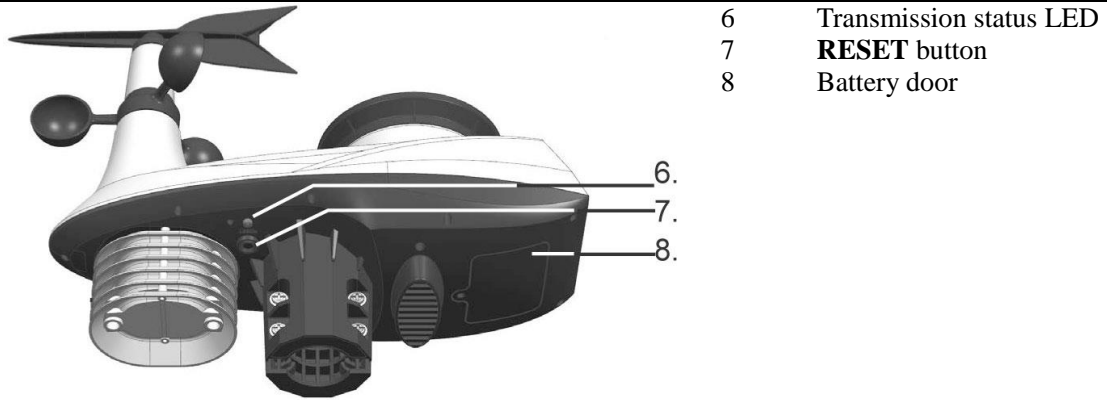
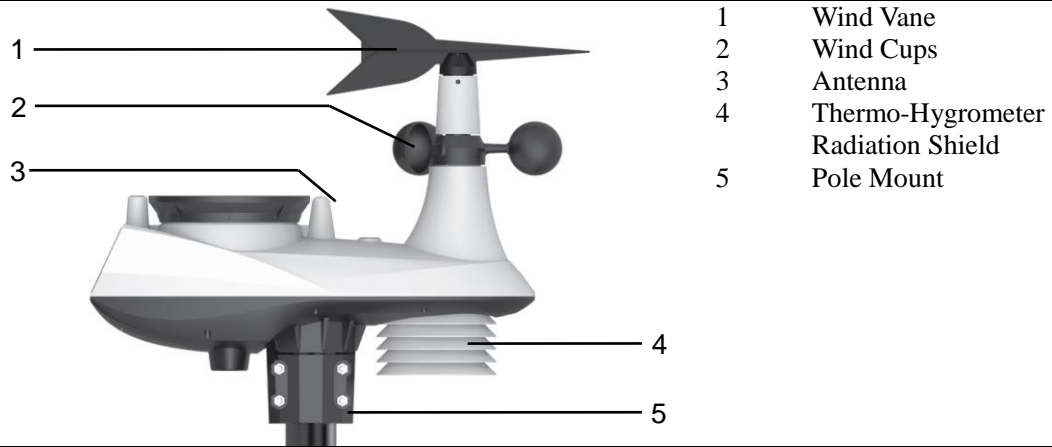


**Figure 3**

No	Description	No	Description
1	Transmitter LED (flashes when the remote is transmitting)	4	[RESET] button
2	Suspension eye for hanging	5	2 x AA battery compartment
3	Transmitter channel (assign the transmitter to 1, 2 ,3 ,4, 5, 6, or 7 default = 1)		

**Note:** The WS-8478A supports seven wireless channels. If you have one sensor, leave the transmitter channel at Channel 1. If you have more than one sensor, set the appropriate channel, then power down and up the sensor (by removing and reinserting batteries).

### 3.3.3 Sensor Array






**Figure 4**

### 3.4 Powering Up

#### 3.4.1 Power Up Sequence

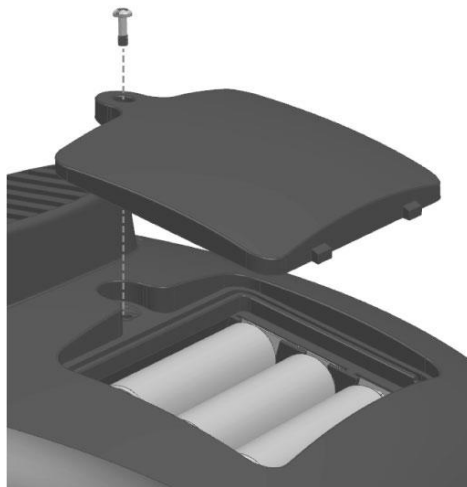
 **Note:** The power up sequence must be performed in the order shown in this section (remote transmitters **FIRST**, Display Console **SECOND**) to avoid sensor synchronization time out.

##### The Indoor Wireless Transmitter(s):

1. Remove the battery door on the sensor(s)
2. If you have more than one sensor, make sure each sensor is on a different channel (reference Figure 3).
3. Insert 2 x AA batteries into the battery compartment.
4. Replace the battery door.

##### The Outdoor Sensor Array:

1. Unscrew the battery door at the bottom of the sensor array, and insert 3 x AA batteries according to the polarity information marked on the battery compartment.



**Figure 5**

2. Replace the battery door and screw on tightly.
3. The transmission status LED will begin flashing once per 12 seconds.


##### The Console:

**Important Note:** The power up sequence must be performed in this order (battery first, AC adapter second) to prevent a low battery indication at power up.

1. Place the two wireless sensors about 5 to 10 feet from the display console.
2. Remove the battery door of the main console and insert three fresh AAA batteries.



3. Replace the battery door
4. Plug the AC adaptor into the DC jack of the console.
5. After power up, all of LCD segments will be displayed. The console will enter access point (AP) mode, and the status LED will flash green.
6. **Do not touch any buttons until sensor synchronization is complete.**

 **Note:** If no display is present after powering up the console, press the **[RESET]** button on the back of the console with an open ended paper clip or sharp tool.

### 3.4.2 Initial Sensor Synchronization

The console will automatically search for and connect to the indoor and outdoor sensors after it is powered up. You can also press **[WI-FI / SENSOR]** button to force the console to search for the sensors, and the console's status LED will flash blue during the sensor(s) searching mode.

Once the indoor sensor connection is successful, the antenna mark and readings for indoor temperature & humidity will appear on the display.

Once the outdoor sensor connection is successful, the antenna mark and readings for outdoor temperature, humidity, wind speed, wind direction, rainfall and UV will appear on the display.

### 3.5 Mount the Indoor Sensor

The indoor sensor can be free standing on a table, or mounted on a vertical wall with a nail ore screw. For best results, place between 10 and 100 feet of the display console.

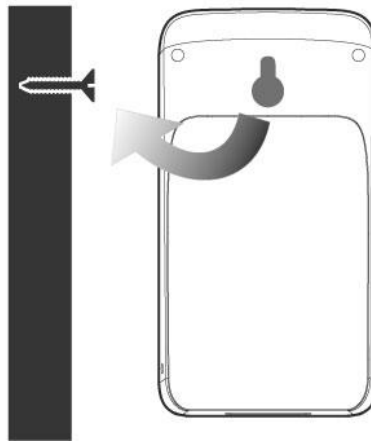


Figure 6

### 3.6 Mount the Outdoor Sensor Array

#### 3.6.1 Site Survey

Perform a site survey before installing the sensor array. Consider the following:

1. You must clean the rain gauge every few months and change the batteries every 2-3 years. Provide easy access to the weather station.
2. Avoid radiant heat transfer from buildings and structures. In general, install the sensor array at least 5' from any building, structure, ground, or roof top.
3. Avoid wind and rain obstructions. The rule of thumb is to install the sensor array at least four times the distance of the height of the tallest obstruction. For example, if the building is 20' tall, and the mounting pole is 6' tall, install  $4 \times (20 - 6) = 56'$  away.

4. **Wireless Range.** The radio communication between receiver and transmitter in an open field can reach a distance of up to 300 feet, providing there are no interfering obstacles such as buildings, trees, vehicles, high voltage lines. Wireless signals will not penetrate metal buildings. Under most conditions, the maximum wireless range is 100’.
5. Radio interference such as PCs, radios or TV sets can, in the worst case, entirely cut off radio communication. Please take this into consideration when choosing console or mounting locations. Make sure your display console is at least five feet away from any electronic device to avoid interference.
6. Visit Ambient Weather Mounting Solutions for assistance and ideas for mounting your weather station:

<http://www.ambientweather.com/amwemoso.html>

### 3.6.2 Pole Mounting the Sensor Array

The sensor array includes an easy mounting bracket for mounting to any pole between 1” and 1.75”. If your pole diameter is greater than 1.75”, consider a mast-to-mast mounting bracket and standard 1 3/8” pole available from Ambient Weather.

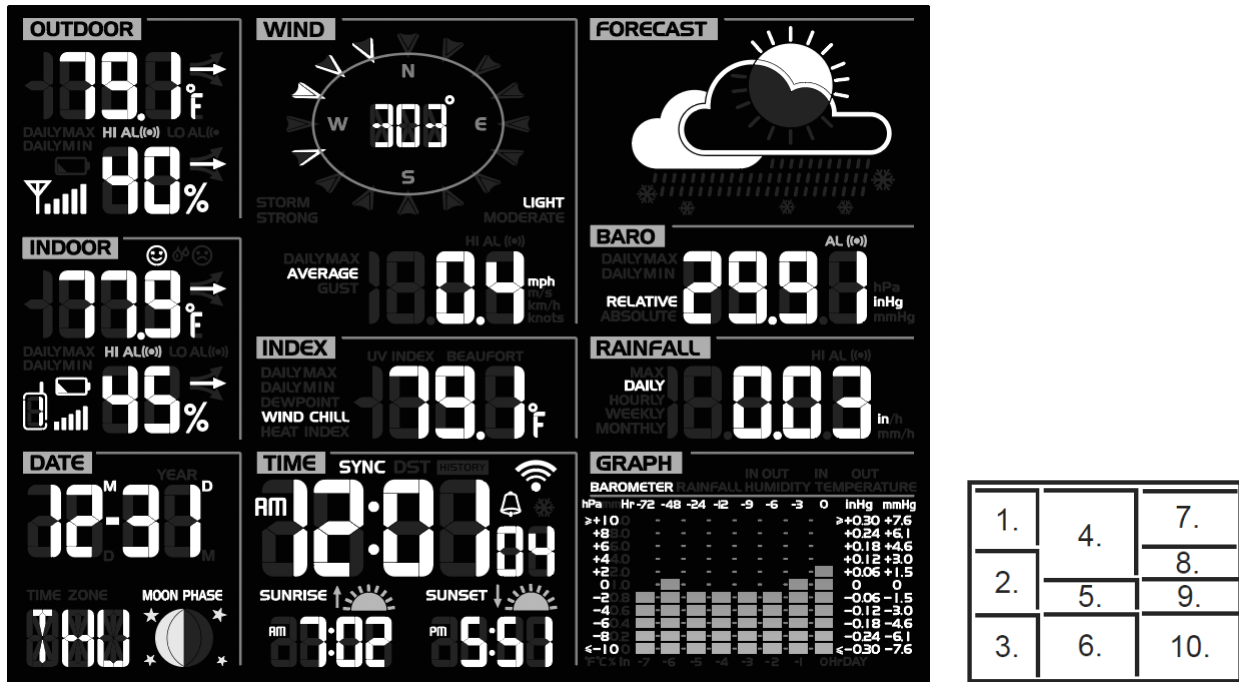
Mount the sensor array mounting bracket to your pole (**not included**) using a Philips screwdriver. Tighten the bolts to the nuts seated inside the hexagonal bolt wells.

Before completely tightening, point the wind vane to the North (solar panel to the South), as shown in Figure 7.



**Figure 7**

## 4. Console Display



No	Description	No	Description
1	Outdoor temperature & humidity	6	Time, sunrise/sunset & system status
2	Indoor temperature & humidity	7	Weather forecast
3	Calendar & moon phase	8	Barometer
4	Wind direction & speed	9	Rainfall
5	Heat Index & Wind Chill	10	Multi-Function Graph





Figure 8

## 5. Settings

### 5.1 Time Settings

While in normal time mode, perform the following operations to set the time.

Command	Mode	Settings	Image
[CLOCK SET] + 2 seconds	Enter Time Zone Settings	Press [▲] to increase, [▼] to decrease. Reference Figure 10.	
[CLOCKSET]	Enter Daylight Savings Time OFF (AZ and HI) or ON (everywhere else).	Press [▲] or [▼] to turn ON or OFF.	
[CLOCKSET]	Hour	Press [▲] to increase, [▼] to decrease.	
[CLOCKSET]	Minute	Press [▲] to increase, [▼] to decrease.	
[CLOCKSET]	Second	Press [▲] to reset to 0.	
[CLOCKSET]	Hour Format	Press [▲] to toggle between 12 Hr and 24 Hr format.	 
[CLOCKSET]	Year	Press [▲] to increase, [▼] to decrease.	
[CLOCKSET]	Month	Press [▲] to increase, [▼] to decrease.	

[CLOCKSET]	Day	Press [^] to increase, [v] to decrease.	
[CLOCKSET]	Month Day Format	Press [^] or [v] to toggle between M-D (month-day) and D-M (day-month)	
[CLOCKSET]	Enable or disable the internet time sync	Press [^] or [v] to turn ON or OFF	
[CLOCKSET]	Language	Press [^] or [v] to change between EN (English), DE (German), FR (French), ES (Spanish) IT (Italian), NL (Dutch), and RU (Russian)	
[CLOCKSET]	Exit Time Settings		

[CLOCKSET] + 2 seconds means press and hold the **CLOCKSET** button on the back of the display console for two seconds.

[CLOCKSET] means press but do not hold the **CLOCKSET** button.

**Figure 9**

### 5.1.1 Time Zone Settings

The following table provides times zones throughout the world. Locations in the eastern hemisphere are positive, and locations in the western hemisphere are negative.

Hours from GMT	Time Zone	Cities
-12	IDLW: International Date Line West	---
-11	NT: Nome	Nome, AK
-10	AHST: Alaska-Hawaii Standard CAT: Central Alaska HST: Hawaii Standard	Honolulu, HI
-9	YST: Yukon Standard	Yukon Territory
-8	PST: Pacific Standard	Los Angeles, CA, USA
-7	MST: Mountain Standard	Denver, CO, USA

Hours from GMT	Time Zone	Cities
-6	CST: Central Standard	Chicago, IL, USA
-5	EST: Eastern Standard	New York, NY, USA
-4	AST: Atlantic Standard	Caracas
-3	---	São Paulo, Brazil
-2	AT: Azores	Azores, Cape Verde Islands
-1	WAT: West Africa	---
0	GMT: Greenwich Mean WET: Western European	London, England
1	CET: Central European	Paris, France
2	EET: Eastern European	Athens, Greece
3	BT: Baghdad	Moscow, Russia
4	---	Abu Dhabi, UAE
5	---	Tashkent
6	---	Astana
7	---	Bangkok
8	CCT: China Coast	Beijing
9	JST: Japan Standard	Tokyo
10	GST: Guam Standard	Sydney
11	---	Magadan
12	IDLE: International Date Line East NZST: New Zealand Standard	Wellington, New Zealand

**Figure 10**

### 5.2 Month Day vs. Year Display

To change the date field from Month / Day to Year, press (do not hold) the **CLOCKSET** button.

### 5.3 Moon Phase

The phase of the moon is determined by the time, date and time zone. Figure 11 displays the moon phases for the Northern and Southern Hemisphere.

Reference Section 5.9.4 for selecting the Northern or Southern Hemisphere.



Northern hemisphere	Moon Phase	Southern hemisphere
	New Moon	
	Waxing Crescent	
	First quarter	
	Waxing Gibbous	
	Full Moon	
	Waning Gibbous	
	Third quarter	
	Waning Crescent	

Figure 11


#### 5.4 Sunrise and Sunset

The console calculates your location’s sunrise and sunset time based on your time zone, latitude and longitude you entered.




Figure 12

#### 5.5 WiFi Connection Status

When the console successfully connects to your Wi-Fi router, the Wi-Fi signal icon  will appear on the LCD display. If the Wi-Fi signal is not stable or the console is trying to connect to the router, the icon will flash. If the icon disappears, it means the console is not connected to the Wi-Fi router.



#### 5.6 Time Server Sync Status

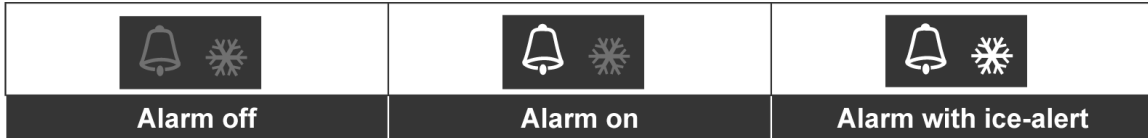
After the console has connected to the internet, it will attempt to connect to the internet time server to obtain the UTC time. Once the connection succeeds and the console's time has been updated, the  icon will appear on the display. If the console cannot sync the time server, you can press the

**REFRESH** button to force the time synchronization process, and the status LED will flash purple.

## 5.7 Alarm Settings

### 5.7.1 Turning On and Off the Alarm Feature

In normal mode, press the **ALARM** button to show the alarm time. Press the alarm button again, and the alarm icon  will appear. Press the alarm button again, and the pre-alert icon  will appear. Press the alarm button again, and the alarm and pre-alert to turn off, and no alarm will sound.



**Figure 13**

#### 5.7.1.1 Pre-Alert Feature

The pre-alert wakes you 30 minutes earlier if ice is predicted to allow you extra time to get to work or school.

Once the ice pre-alert is activated, the alarm will sound 30 minutes earlier if the outdoor temperature is below -3°C (26.6 °F), where ice is likely to form.

### 5.7.2 Setting the Alarm Time

While in normal mode, perform the following operations to set the alarm time.

Command	Mode	Settings
[ALARM] + 2 seconds	Enter Alarm Settings Alarm Hour	Press [UP] to increase, [DOWN] to decrease.
[ALARM]	Alarm Minute	Press [UP] to increase, [DOWN] to decrease.
[ALARM]	Exit Alarm Settings	

[ALARM] + 2 seconds means press and hold the ALARM button on the back of the display for two seconds.

[ALARM] means press but do not hold the ALARM button on the back of the display.

**Figure 14**

### 5.7.3 Using the Alarm and Snooze Functions

When the alarm sounds, press and hold the **ALARM / SNOOZE** button for two seconds to turn off the alarm sound. The alarm bell will stop flashing.

If no button is pressed during the alarm period, the alarm will turn off automatically after two minutes.

To temporarily silence the alarm, press the **ALARM / SNOOZE** button on the top of the console. The alarm bell icon will keep flashing.

If the snooze function is turned on, the 4-step crescendo alarm will sound every 2 minutes. Press and hold the **ALARM / SNOOZE** button for two seconds to turn off the alarm sound. The alarm bell will stop flashing.



## 5.8 Temperature and Humidity Display and Settings

### 5.8.1 Temperature Units of Measure

Press the °F / °C button on the front of the display to change the temperature units of measure.

### 5.8.2 Outdoor Sensor Array Signal Strength

The outdoor sensor array signal strength is displayed in the outdoor section of the display:

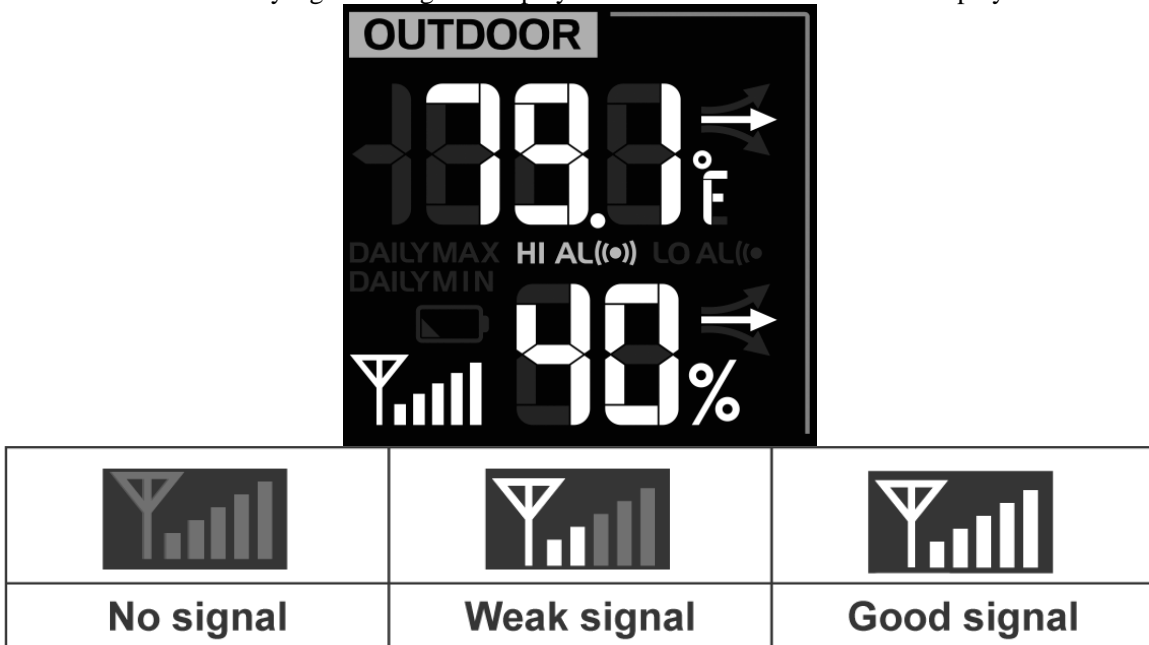





Figure 15

### 5.8.3 Indoor Sensor

#### 5.8.3.1 Indoor Sensor Signal Strength

The indoor sensor signal strength is displayed in the indoor section of the display, next to the channel number:



		
<b>No signal</b>	<b>Weak signal</b>	<b>Good signal</b>

**Figure 16**

### 5.8.3.2 Changing Indoor Channel Numbers

The console supports up to seven wireless indoor/outdoor sensors. If you have two or more sensors, press the **CHANNEL** button to switch to different channels.

Press and hold the **CHANNEL** button for two seconds to automatically scroll between the indoor channels every four seconds. To stop the automatic scrolling, press the **CHANNEL** button again.

### 5.8.3.3 Indoor Comfort Icon

The comfort indication is a pictorial indication calculated from the indoor air temperature and humidity. Each indoor channel displays a comfort icon.

The comfort indication can vary at the same temperature, depending on the humidity. There is no comfort Indication when the temperature is below 0°C (32°F) or over 60°C (140°F).

		
<b>Too cold</b>	<b>Comfortable</b>	<b>Too hot</b>

**Figure 17**

### 5.8.4 Temperature and Humidity Trend

The temperature trend arrow indicator displays the current rate of change of the indoor and outdoor temperature and humidity.

Arrow indicator			
Trend	Rising	Steady	Falling

**Figure 18**

### 5.8.5 Temperature and Humidity Measurements Limits

When temperature is below -40 °C, (-40 °F), the LCD will display “Lo”. If temperature is above 80 °C (176 °F), LCD will display “HI”.

When humidity is below 1%, the LCD will display “Lo”. If humidity is above 99%, the LCD will display “HI”.

## 5.9 Wind

The wind section displays wind speed (gust or average), current wind direction, predominant wind direction (over the last 5 minutes), and wind speed level.



**Figure 19**

### 5.9.1 Average Wind Speed vs. Wind Gust

To change the display between average wind speed and wind gust, press the WIND button on the top of the display.

The wind speed is the average calculated by the sensor array in the 12 second update period. The wind gust is the maximum calculated by the sensor array in the 12 seconds update period, and then passed to the console. Thus, you never miss a wind gust.

### 5.9.2 Wind Units of Measure and Wind Direction Format

While in normal mode, perform the following operations to change the wind settings.

Command	Mode	Settings
[WIND] + 2 seconds	Enter Wind Settings Wind Speed Units of Measure	Press [^] to change between m/s → km/h → knots → mph
[WIND]	Wind Direction Format	Press [^] to change between degrees (0-360°) and 16-point compass direction.
[WIND]	Exit Wind Settings	

[WIND] + 2 seconds means press and hold the **WIND** button on the top of the display for two seconds.

[WIND] means press but do not hold the **WIND** button on the top of the display.

### 5.9.3 Wind Speed Level

Level	LIGHT	MODERATE	STRONG	STORM
Speed	0.1km/h ~19km/h	20km/h ~ 49km/h	50km/h ~ 88km/h	> 89km/h

**Figure 20**

### 5.9.4 Calibrating the Wind Direction for the Southern Hemisphere

The outdoor sensor array is calibrated to point to the North when the solar collector is facing the south. If you live in the Southern Hemisphere, you will need to point the solar connector to the North and calibrate the wind direction 180 degrees.

1. Point the wind sensor to the South instead of the North, as shown in Figure 7.
2. Press and hold the **INDEX** button for eight seconds to enter UV index calibration mode, then

- 
- press the **INDEX** button again until the “**N**” icon appears on the weekday location.
3. Press the [**^**] button to change to the Southern Hemisphere. The “**S**” icon will appear.
  4. Press the **INDEX** button to confirm and exit.

Note: Changing the hemisphere setting will automatically switch the direction of the moon phase on the display.

## 5.10 Barometric Pressure Display and Settings

Note: The barometric pressure sensor is inside the console. Barometric pressure is the same inside or outside of your home or facility.

### 5.10.1 Barometric Pressure Units of Measure

In normal time mode, press the **BARO** button (on the top of the console) to change barometric units of measure (hPa / inHg / mmHg).

### 5.10.2 Absolute Pressure vs. Relative Pressure

Press and hold the **BARO** button for 2 seconds to enter barometric mode, and press the [**^**] button to switch between the relative and absolute pressure reading.

### 5.10.3 Relative Pressure Calibration

*Please Reference Section 5.10.3.1 for details on the purpose of calibrating relative pressure, and how to determine relative pressure in your area.*

1. Press and hold the **BARO** button for 2 seconds to enter barometric mode. The icon **RELATIVE** or **ABSOLUTE** will flash.

Make sure the **RELATIVE** Pressure is showing on the display. If **ABSOLUTE** Pressure is showing, switch to **RELATIVE** pressure per Section 5.10.2.

2. Press (do not hold) the **BARO** button again. The relative pressure will flash.
3. Press the [**^**] button to increase the relative pressure and the [**v**] to decrease the relative pressure.
4. Press (do not hold) the **BARO** button again to exit the relative pressure calibration mode, or wait 60 seconds to time out.

Note: After calibration, the barograph will reset to 0 change (flat line across the graph).

#### 5.10.3.1 Relative vs. Absolute Pressure and Calibration

The console displays two different pressures: absolute (measured) and relative (corrected to sea-level).

To compare pressure conditions from one location to another, meteorologists correct pressure to sea-level conditions. Because the air pressure decreases as you rise in altitude, the sea-level corrected relative pressure (the pressure your location would be at if located at sea-level) is generally higher than your measured absolute pressure.

Thus, your absolute pressure may read 28.62 inHg (969 mb) at an altitude of 1000 feet (305 m), but the relative pressure is 30.00 inHg (1016 mb).

The standard sea-level pressure is 29.92 in Hg (1013 mb). This is the average sea-level pressure

around the world. Relative pressure measurements greater than 29.92 inHg (1013 mb) are considered high pressure and relative pressure measurements less than 29.92 inHg are considered low pressure.

To determine the relative pressure for your location, locate an official reporting station near you (the internet is the best source for real time barometer conditions, such as Weather.com or Wunderground.com), and set your weather station to match the official reporting station.

### 5.11 The Forecast

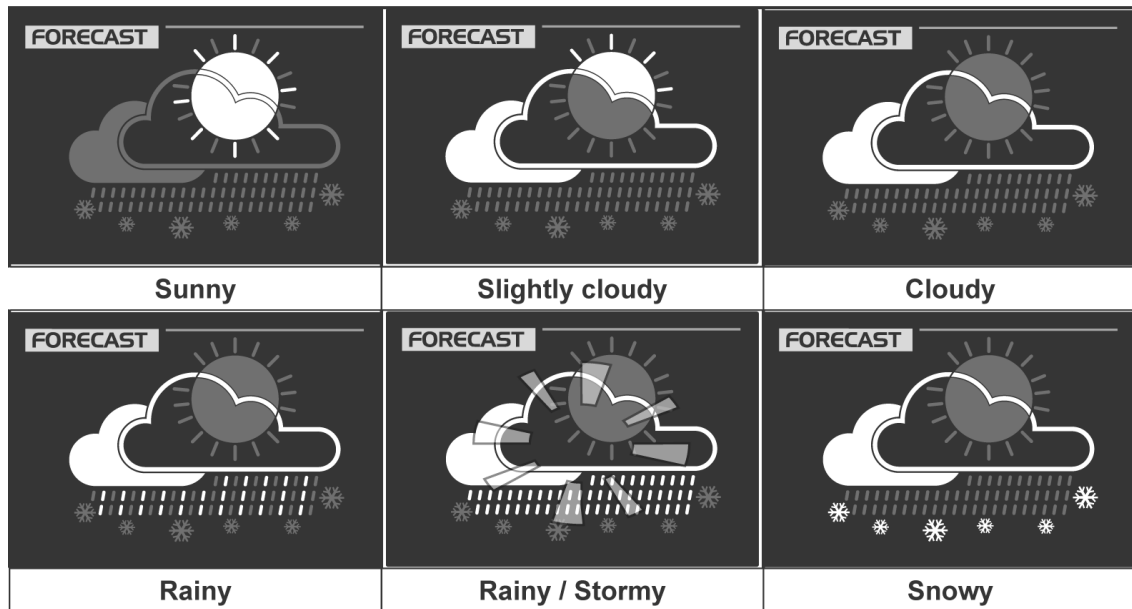
The weather forecast or pressure tendency is based on the rate of change of barometric pressure. In general, when the pressure increases, the weather improves (sunny to partly cloudy) and when the pressure decreases, the weather degrades (cloudy to rain).

When the pressure drops rapidly, the storm icon will be displayed.

It may take several days to begin forecasting the weather. In the meantime, the partly cloudy icon will be displayed.

The weather forecast is an estimation or generalization of weather changes in the next 12 to 48 hours, and varies from location to location. The tendency is simply a tool for projecting weather conditions and is never to be relied upon as an accurate method to predict the weather.

The “Snowy” weather forecast is based on the outdoor temperature, and will be displayed when the outdoor temperature is below -3°C (26°F).



**Figure 21**

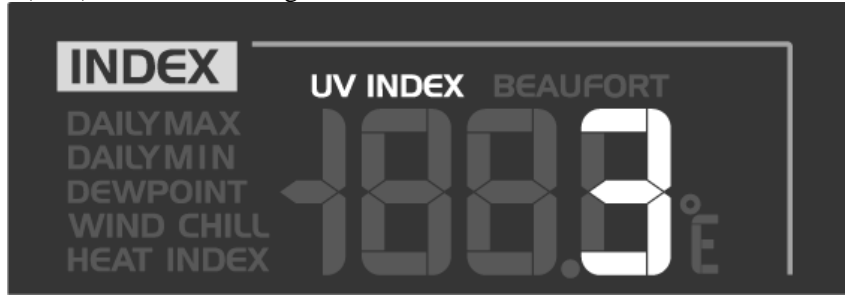
### 5.12 Weather Index

The Weather Index displays the parameters UV Index, Beaufort Scale, Wind Chill, Heat Index and Dew Point.

In normal mode, press the **INDEX** button on the top of the display to view the following parameter in this sequence:

### 5.12.1 UV Index

The UV index (UVI) is based on a range of 0 – 16.



**Figure 22**

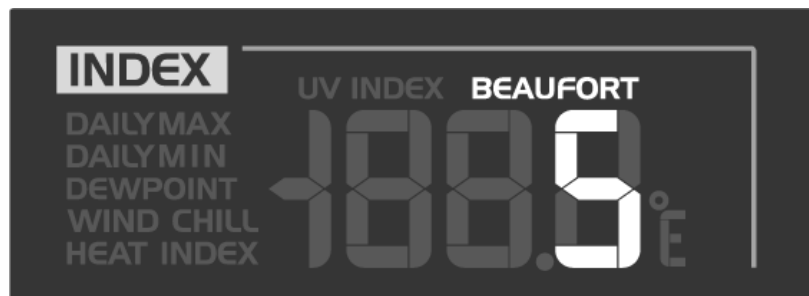
The US EPA defines the UVI as follows:

UVI	Rating	Comments
0-2	Low	A UV Index reading of 0 to 2 means low danger from the sun's UV rays for the average person.
3-5	Medium	A UV Index reading of 3 to 5 means moderate risk of harm from unprotected sun exposure.
6-7	High	A UV Index reading of 6 to 7 means high risk of harm from unprotected sun exposure. Protection against skin and eye damage is needed.
8-10	Very High	A UV Index reading of 8 to 10 means very high risk of harm from unprotected sun exposure. Take extra precautions because unprotected skin and eyes will be damaged and can burn quickly.
11-16	Extreme	A UV Index reading of 11 or more means extreme risk of harm from unprotected sun exposure. Take all precautions because unprotected skin and eyes can burn in minutes.

**Figure 23**

### 5.12.2 Beaufort Scale

The Beaufort Scale is an international scale of wind velocities ranging from 0 (calm) to 12 (Hurricane force).



**Figure 24**

The Beaufort Scale is defined as follows:

Beaufort Scale	Description	Wind Speed	Land Condition
----------------	-------------	------------	----------------

0	Calm	< 1 km/h	Calm. Smoke rises vertically.
		< 1 mph	
		< 1 knot	
		< 0.3 m/s	
1	Light air	1.1 - 5.5 km/h	Smoke drift indicates wind direction. Leaves and wind vanes are stationary.
		1 - 3 mph	
		1 - 3 knot	
		0.3 - 1.5 m/s	
2	Light breeze	5.6 - 11 km/h	Wind felt on exposed skin. Leaves rustle. Wind vanes begin to move.
		4 - 7 mph	
		4 - 6 knot	
		1.6 - 3.3 m/s	
3	Gentle breeze	12 - 19 km/h	Leaves and small twigs constantly moving, light flags extended.
		8 - 12 mph	
		7 - 10 knot	
		3.4 - 5.4 m/s	
4	Moderate breeze	20 - 28 km/h	Dust and loose paper raised. Small branches begin to move.
		13 - 17 mph	
		11 - 16 knot	
		5.5 - 7.9 m/s	
5	Fresh breeze	29 - 38 km/h	Branches of a moderate size move. Small trees in leaf begin to sway.
		18 - 24 mph	
		17 - 21 knot	
		8.0 - 10.7 m/s	
6	Strong breeze	39 - 49 km/h	Large branches in motion. Whistling heard in overhead wires. Umbrella use becomes difficult. Empty plastic bins tip over.
		25 - 30 mph	
		22 - 27 knot	
		10.8 - 13.8 m/s	
7	High wind	50 - 61 km/h	Whole trees in motion. Effort needed to walk against the wind.
		31 - 38 mph	
		28 - 33 knot	
		13.9 - 17.1 m/s	
8	Gale	62 - 74 km/h	Some twigs broken from trees. Cars veer on road. Progress on foot is seriously impeded
		39 - 46 mph	
		34 - 40 knot	
		17.2 - 20.7 m/s	
9	Strong gale	75 - 88 km/h	Some branches break off trees, and some small trees blow over. Construction /temporary signs and barricades blow over.
		47 - 54 mph	
		41 - 47 knot	
		20.8 - 24.4 m/s	
10	Storm	89 - 102 km/h	Trees are broken off or uprooted, structural damage likely.
		55 - 63 mph	
		48 - 55 knot	

		24.5 - 28.4 m/s	
11	Violent storm	103 - 117 km/h	Widespread vegetation and structural damage likely.
		64 - 73 mph	
		56 - 63 knot	
		28.5 - 32.6 m/s	
12	Hurricane force	$\geq 118$ km/h	Severe widespread damage to vegetation and structures. Debris and unsecured objects are hurled about.
		$\geq 74$ mph	
		$\geq 64$ knot	
		$\geq 32.7$ m/s	

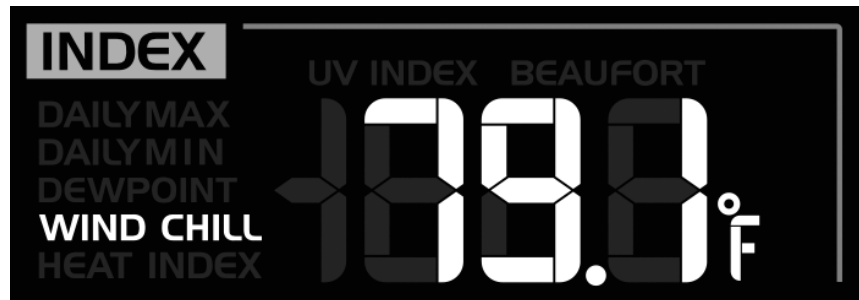
**Figure 25**

### 5.12.3 Wind Chill

Wind Chill is the perceived decrease in air temperature felt by the body on exposed skin due to the flow of air, and is calculated based on temperature and wind speed.

Wind chill numbers are always lower than the air temperature for values where the formula is valid.

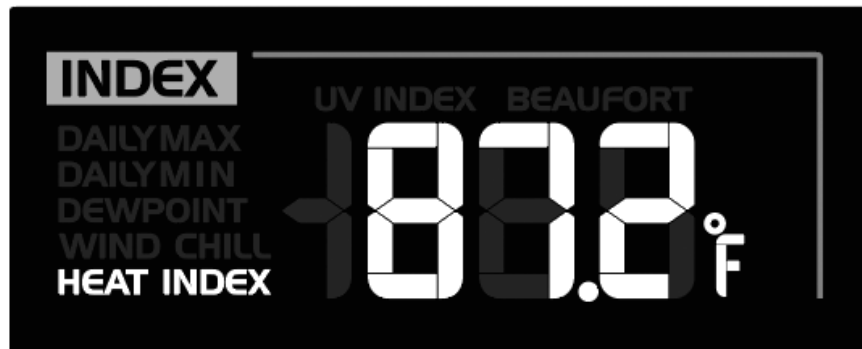
The wind chill calculation is only valid for temperatures less than 40 °F and wind speeds greater than 0 mph, according to the National Weather Service.



**Figure 26**

### 5.12.4 Heat Index

Heat Index is an index that combines air temperature and relative humidity, as an attempt to determine the human-perceived equivalent temperature.



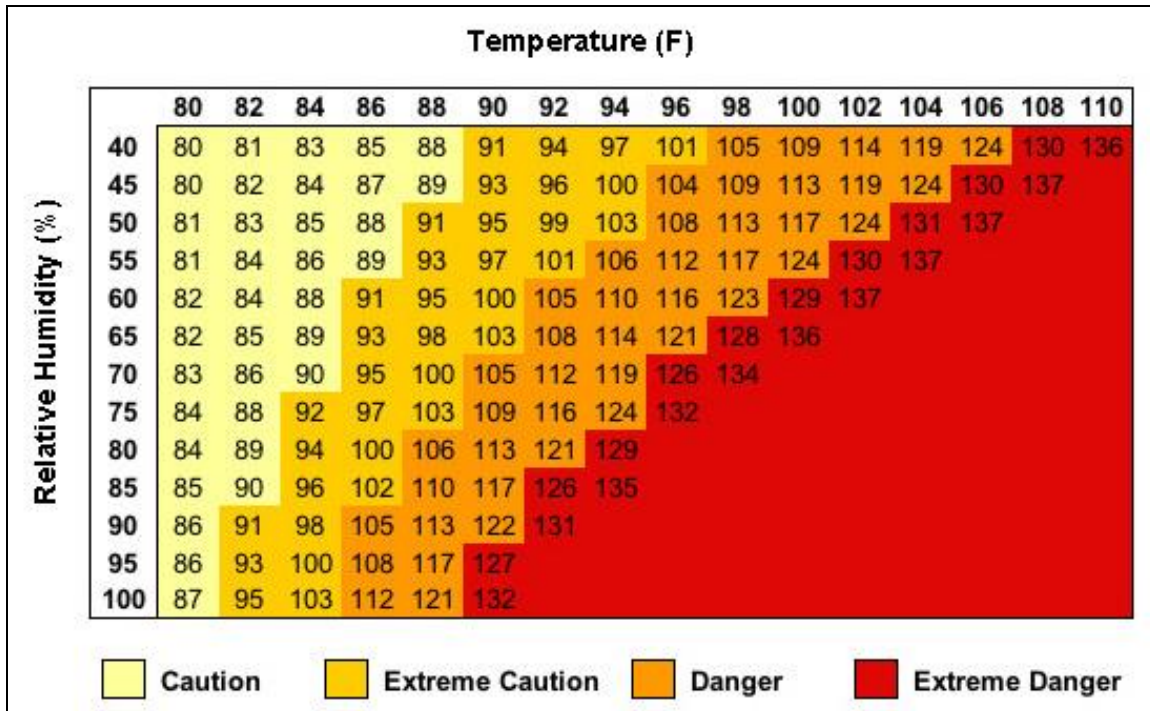
**Figure 27**

The heat index calculation is only valid for temperatures greater than 80 °F and less than 120 °F, and humidity greater than 40%, according to the National Weather Service.



Level	Heat Index Range (°F)	Notes
Caution	80-90	Fatigue is possible with prolonged exposure and activity. Continuing activity could result in heat cramps.
Extreme Caution	90-105	Heat cramps and heat exhaustion are possible. Continuing activity could result in heat stroke.
Danger	105-130	Heat cramps and heat exhaustion are likely; heat stroke is probable with continued activity.
Extreme Danger	Over 130	Heat stroke is imminent.

**Figure 28**



**Figure 29**

### 5.12.5 Dew Point

The dew point is the temperature below which the water vapor in air at constant barometric pressure condenses into liquid water at the same rate at which it evaporates. The condensed water is called dew when it forms on a solid surface.

The dew point temperature is determined by the temperature & humidity data from outdoor sensor.

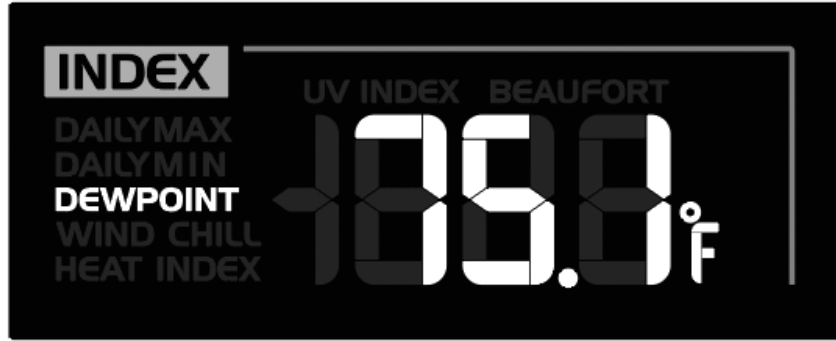


Figure 30

### 5.13 Rainfall

The rainfall displays total rain (since the last reset), hourly, daily, weekly, or monthly rain.



Figure 31

#### 5.13.1 Rain Units of Measure

Command	Mode	Settings
[RAINFALL] + 2 seconds	Enter Rain Settings Rain Units of Measure	Press [^] to change between mm → inch
[RAINFALL]	Exit Rain Settings	

[RAINFALL] + 2 seconds means press and hold the **RAINFALL** button on the top of the display for two seconds.

[RAINFALL] means press but do not hold the **RAINFALL** button on the top of the display.

#### 5.13.3 Rain Increments of Measure

Press (do not hold) the **RAINFALL** button to change increments of measure between

1. **DAILY** - the total rainfall from midnight
2. **HOURLY** - the total rainfall in the past hour

3. **WEEKLY** - the total rainfall of the current week
4. **MONTHLY** - the total rainfall of the current calendar month
5. **TOTAL** – the total rainfall since the last reset.

### 5.13.3 Resetting Rain to Zero

In normal mode, press and hold the **HISTORY** button with 2 sec to reset the rainfall record.

### 5.14 Graph

The history graph (GRAPH), at the bottom right of the LCD displays different weather parameters in bar graph format.

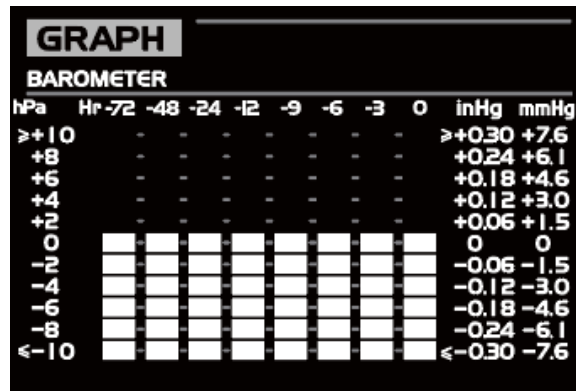
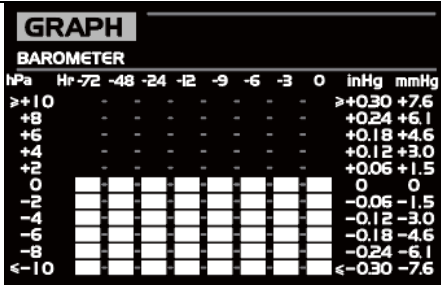
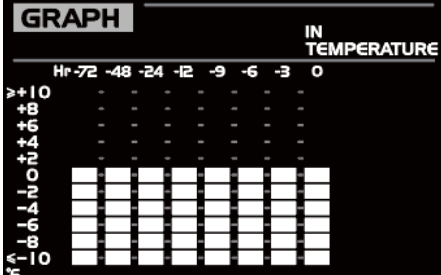
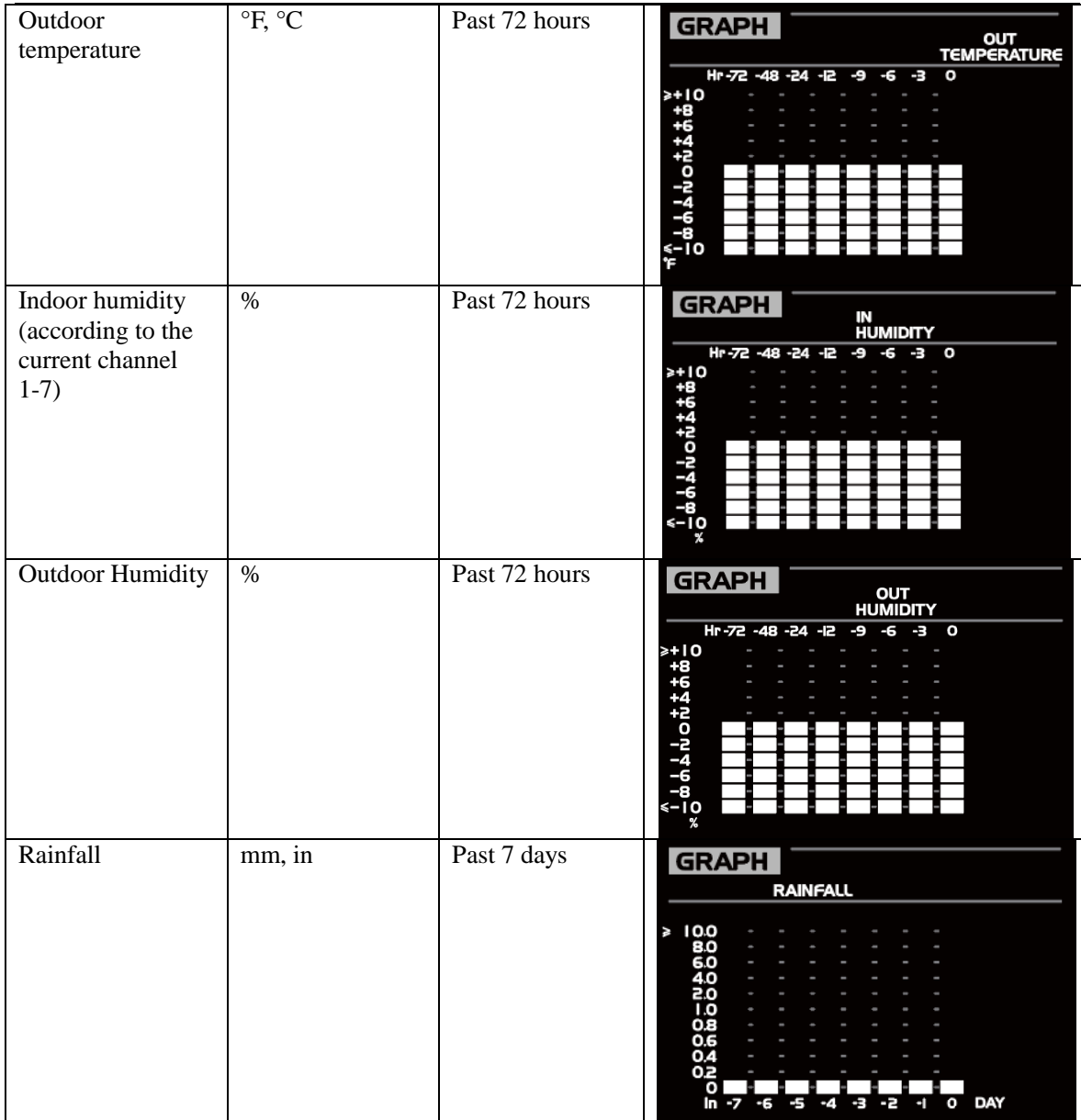


Figure 32

To view different graphs, in normal mode, press **GRAPH / Δ** to toggle between the different graphs:

Weather Parameter	Units of Measure	Record Time Range	Graph
Barometric Pressure	hPa, inHg, mmHg	Past 72 hours	
Indoor temperature (according to the current channel 1-7)	°F, °C	Past 72 hours	



**Figure 33**

### 5.15 Min / Max

Press (do not hold) the **MAX / MIN** button on the front of the display to review the following:

Command	Parameter
[MAX/MIN]	Daily Outdoor MAX temperature & humidity
[MAX/MIN]	Daily Outdoor MIN temperature & humidity
[MAX/MIN]	Daily Indoor MAX temperature & humidity for the current channel displayed
[MAX/MIN]	Daily Indoor MIN temperature & humidity for the current channel displayed
[MAX/MIN]	Average Daily Wind Speed
[MAX/MIN]	Average Daily Wind Gust

[MAX/MIN]	Daily Maximum Dew Point
[MAX/MIN]	Daily Minimum Dew Point
[MAX/MIN]	Daily Maximum Wind Chill
[MAX/MIN]	Daily Minimum Wind Chill
[MAX/MIN]	Daily Maximum Heat Index
[MAX/MIN]	Daily Minimum Heat Index
[MAX/MIN]	Daily Maximum UV Index
[MAX/MIN]	Daily Maximum Beaufort Scale
[MAX/MIN]	Daily Maximum Relative Pressure
[MAX/MIN]	Daily Minimum Relative Pressure
[MAX/MIN]	Daily Maximum Rain Rate

[MAX/MIN] means press the MAX/MIN button

The min and max records reset every day at midnight (12:00am)

To reset the current display min and max records manually, press and hold the **MAX / MIN** button for two seconds to reset the MAX/MIN records.

### 5.16 History Data (Past 24 hours)

The console automatically stores the weather data of the past 24 hours. Press the **HISTORY** repeatedly button to review historical data every hour, on the hour, for the last 24 hours.

The console displays indoor and outdoor temperature and humidity, relative pressure, wind chill, wind speed, rainfall and time and date.

### 5.17 Alerts

This feature alerts you in the event that defined parameters are out of range. Once the alert is met, the alarm will sound and the parameter will flash.

#### 5.17.1 Setting the Alerts

- In normal mode, press the **ALERT** button to enter alert set mode.
- During alert set mode, press the **ALERT** button to switch to the next parameter in the sequence below:

Command	Parameter	Set Range	Display Section	Default Value
[ALERT]	Outdoor temperature high alert	-40°C to 80°C (-40°F to 176°F)	Outdoor temperature & humidity (OUTDOOR)	40 °C (104 °F)
[ALERT]	Outdoor temperature low alert			0 °C (32 °F)
[ALERT]	Outdoor humidity high alert	1% to 99%		80%
[ALERT]	Outdoor humidity low alert			40%
[ALERT]	Indoor temperature high alert	-40°C to 80°C (-40°F to 176°F)	Indoor temperature & humidity (INDOOR)	40 °C (104 °F)
[ALERT]	Indoor temperature low alert			0 °C (32 °F)
[ALERT]	Indoor humidity high alert	1% to 99%		80%
[ALERT]	Indoor humidity low alert			40%
[ALERT]	Wind Speed	m/s to 50 m/s (0.22 mph to 112 mph)	Wind direction & speed section (WIND)	17.2 m/s (38.4 mph)
[ALERT]	Pressure Drop	1 hPa to 10 hPa (0.02 hPa)	Barometer section	3 hPa (0.08 inHg)

		to 0.2 hPa)	(BARO)	
[ALERT]	Rainfall	1 mm to 1000 mm (0.04 in to 39.37 in)	Rainfall section (RAINFALL)	100 mm (3.93 in)
[ALERT]	Exit Alert setting mode			

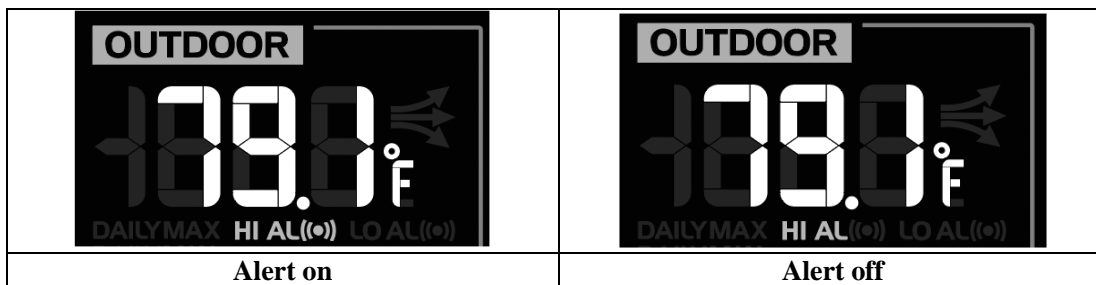
[ALERT] means press the ALERT button

**Figure 34**

8. After selecting the alert parameter, press and hold the **ALERT** buttons for 2 seconds to adjust, and the alert value will flash.
9. Press the [^] or [v] to adjust the alert value up or down, or press and hold the buttons to change rapidly.
10. Press **ALERT** button again (do not hold) to exit the alert set mode and then press the **ALERT** button to switch to the next parameter.

### 5.17.2 Activating an Alert

1. Select the parameter you want to alert per the previous Section 5.17.2 using the **ALERT** button.
2. Press the **ALARM** button to toggle the alarm on or off.



**Figure 35**

### 5.17.3 Silencing an Alert

Once an alert is triggered, the alarm will sound for two minutes, and the related alert icon will flash.

Press **ALARM / SNOOZE** button to silence the alert alarm and stop the icon from flashing, or the alarm will automatically turn off after two minutes.

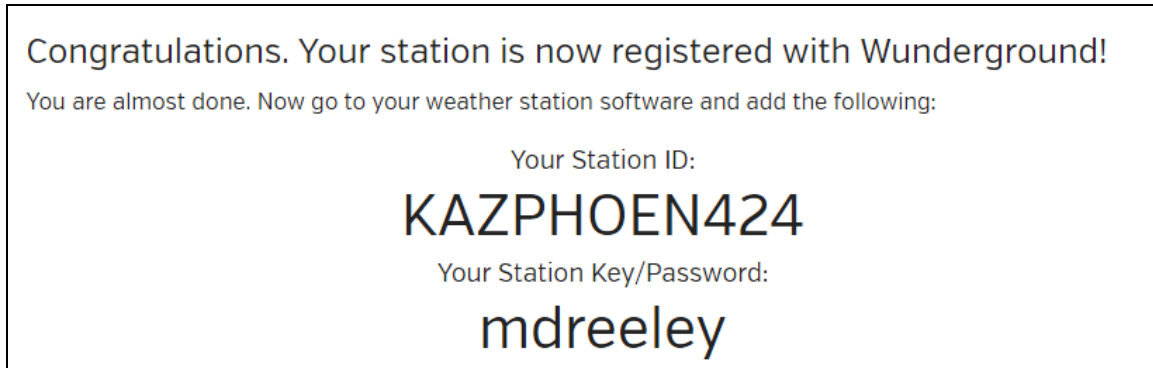
## 6 WiFi Connection and Weather Servers

### 6.1 Register at Wunderground.com (Weather Underground)

Note: The Weather Underground website is subject to change.

1. Visit [Wunderground.com](http://Wunderground.com), and select the [Join](#) link in the upper right and corner and create a Free Account.
2. From the menu, Select **More | Add a Weather Station**, or visit: <https://www.wunderground.com/personal-weather-station/signup>
3. Click **Send Validation Email**. Respond to the validation email from Wunderground (it may take a several minutes).
4. Revisit **More | Add a Weather Station**, or visit: <https://www.wunderground.com/personal-weather-station/signup> again and enter all of the information requested.

5. Once registered, you receive a station ID and password. Make a note of this. You will need to enter it into your weather station web interface shown in Figure 43 (Figure 36 is an example and your station ID and password will be different.



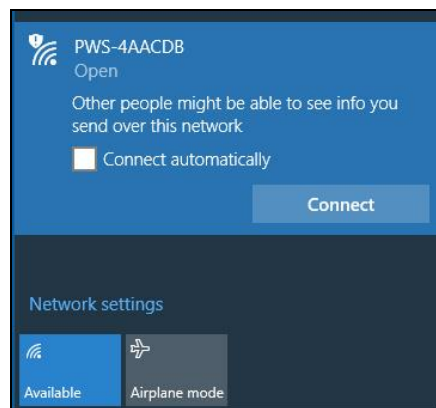
**Figure 36**

**Note:** Your station ID will have the form: KSSCCCC###, where K is for USA station (I for international), SS is your state, CCCC is your city and ### is the station number in that city.



In the example above, KAZPHOEN424 is in the USA (K), State of Arizona (AZ), City of Phoenix (PHOEN) and #424.

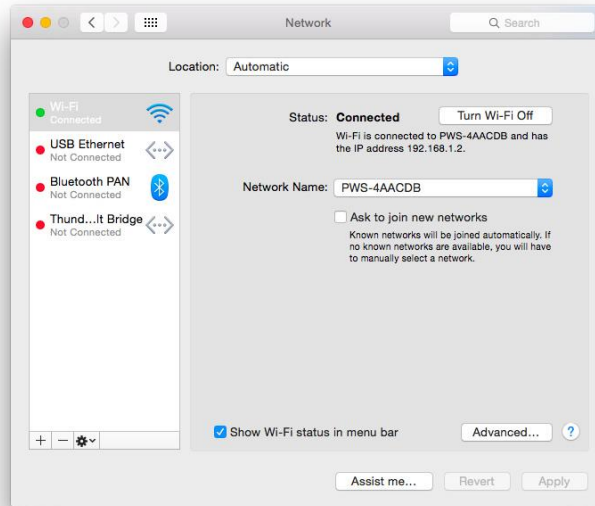
## 6.2 WiFi Setup

1. When you first power up the console, or press and hold the **WI-FI / SENSOR** button for six seconds in normal mode, the console **green LED will flash** to signify that it has entered WAP (wireless access point) mode, and is ready to enter for WIFI settings.
2. Use your smart phone, tablet, or computer to connect to the console through WiFi. Note that when the console programming is complete, you will resume your default WiFi connection. Note that you cannot connect two devices at the same time when programming.
  - a) **Example 1: Connect to the console WiFi server with a PC.** Choose WiFi network settings from Windows (or search “Change Wi-Fi Settings” from Windows), and Connect to the PWS- WiFi network, as shown in Figure 37 (your WiFi network name may be slightly different, but will always begin with PWS-).




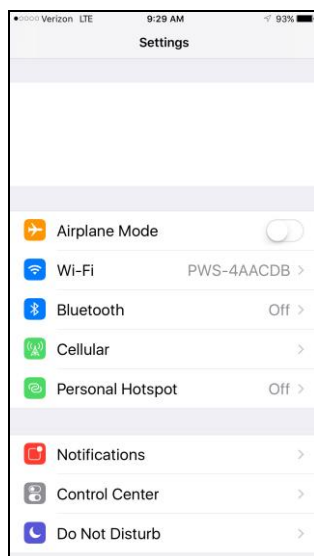
**Figure 37**

- b) **Example 2. Connect to the console WiFi server with a Mac.** Choose the Settings icon  and Network . Connect to the PWS- WiFi network, as shown in Figure 38 (your WiFi network name may be slightly different, but will always begin with PWS-).

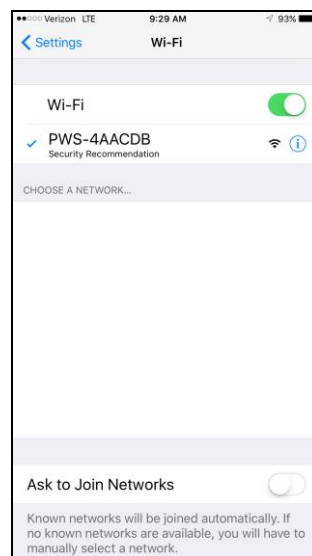


**Figure 38**

- c) **Example 3. Connect to the console WiFi server with an iPhone or iPad.** Choose the Settings icon  and Wi-Fi (Figure 39). Connect to the PWS- WiFi network, as shown in Figure 40 (your WiFi network name may be slightly different, but will always begin with PWS-).




**Figure 39**



**Figure 40**

- d) **Example 4. Connect to the console WiFi server with an Android.** From the Apps



icon, choose the Settings icon  and Wi-Fi (Figure 41). Connect to the PWS- WiFi network, as shown in Figure 42 (your WiFi network name may be slightly different, but will always begin with PWS-).

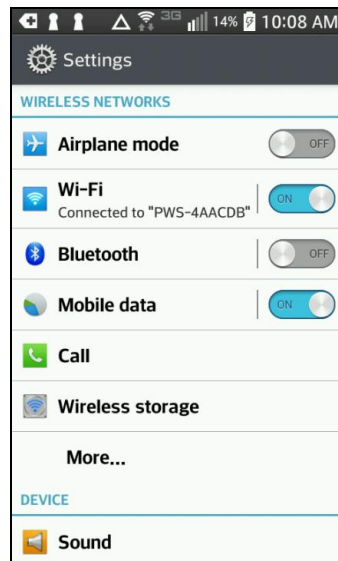


Figure 41

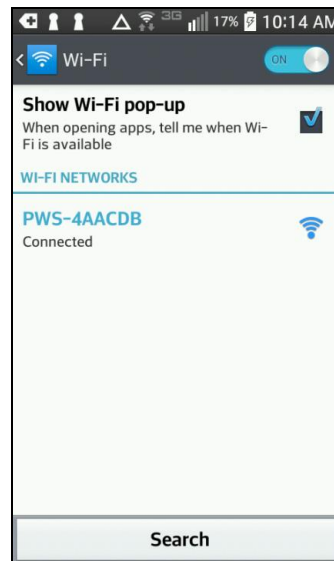


Figure 42

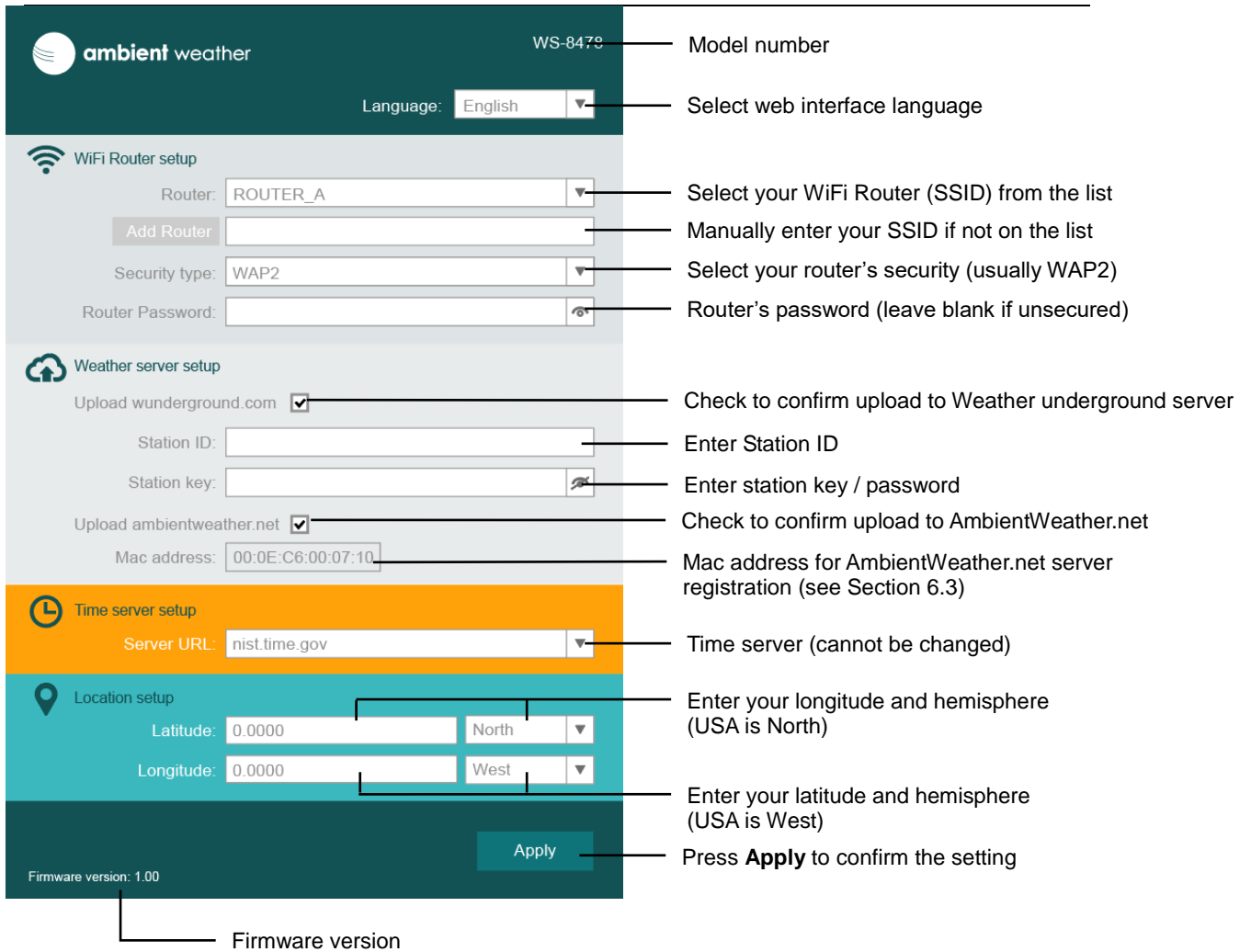
3. Once connected, enter the following IP address into any browser's address bar:

`http://192.168.1.1`  
to access the console's web interface:

**Note:** Some browsers will treat 192.168.1.1 as a search, so make sure you include the header `http://`, or:

`http://192.168.1.1` not `192.168.1.1`

4. Enter the following information into the web interface (Figure 43). Make sure all of the information is entered prior to selecting Apply. If you choose not to use Wunderground.com or AmbientWeather.net, leave the check boxes unchecked.



**Figure 43**

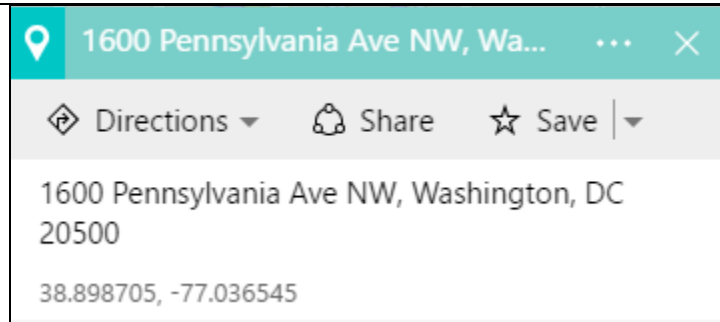
Notes:

- **Make a note of your Mac address.** You will need this to register at AmbientWeather.net.
- **Hidden SSIDs.** If you have a hidden SSID, enter the SSID manually.
- **Finding your Longitude and Latitude.** Visit Bing Maps:

<https://www.bing.com/mapspreview>

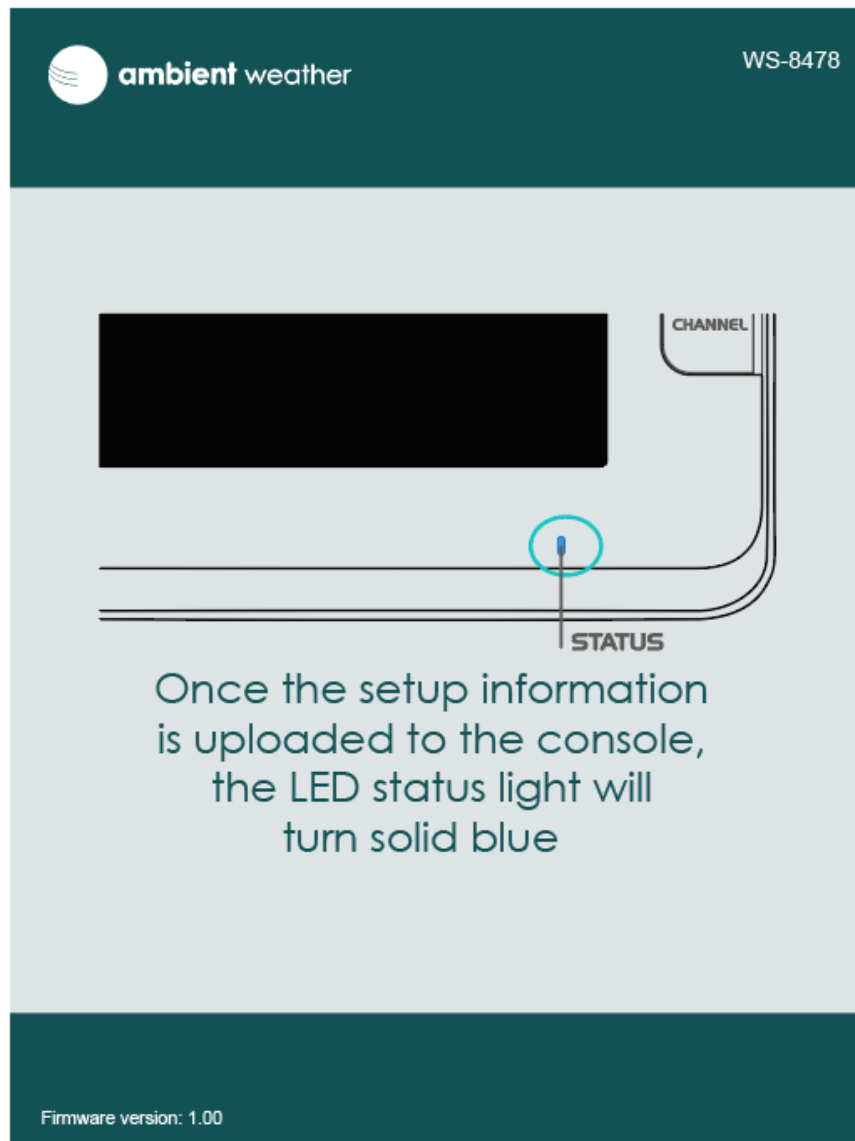
and enter your address.

In the example shown in Figure 44, the latitude is 38.898705 North, and the longitude is 77.036545 West (note that latitude is negative for the southern hemisphere and the longitude is negative for the western hemisphere. Do not enter the negative sign into the longitude field).




**Figure 44**

5. If all of the information you entered, and is correct, the console LED will change from green to blue. If it does not change to blue or keeps flashing, check your web interface information again. The blue flashing light will time out after 30 minutes (if you do not plan on connecting the console to the Internet).

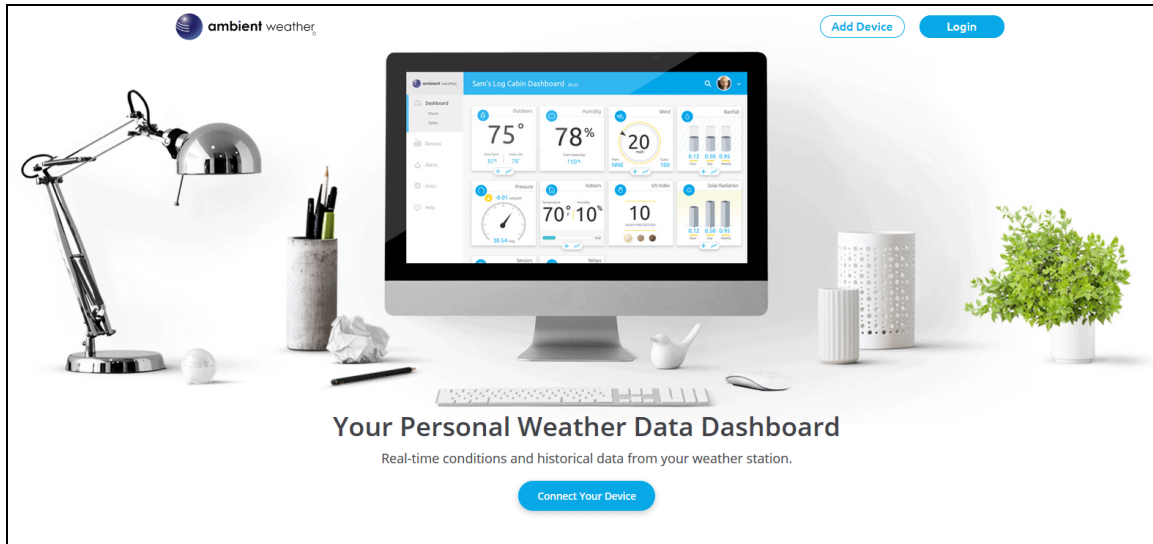


**Figure 45**

6. Once the setup is completed, the Wi-Fi console will disconnect from your computer or smart phone's Wi-Fi connection, and search for the assigned router. If the connection is successful, the Wi-Fi console's status LED will change to blue and the Wi-Fi icon  will stop flashing and remain on.

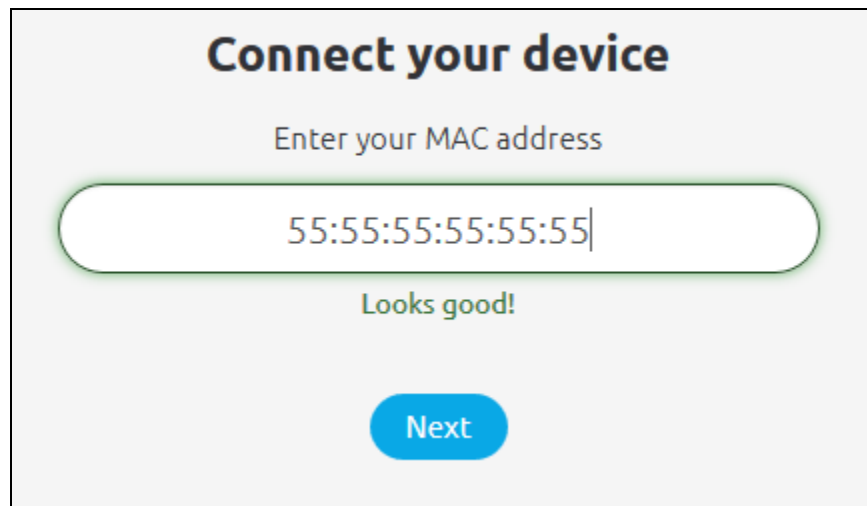
### 6.3 Register with AmbientWeather.net

Visit: [www.AmbientWeather.net](http://www.AmbientWeather.net) to create an account and select Add Device, as shown in Figure 46.



**Figure 46**

Next, enter the MAC address found on your Weather Station Web Interface (Figure 43). Note that this is an example only and your MAC address will be different.



**Figure 47**

Register an account on AmbientWeather.net (email address and password).

Once registered, select the dashboard to view your data, as shown in Figure 48.

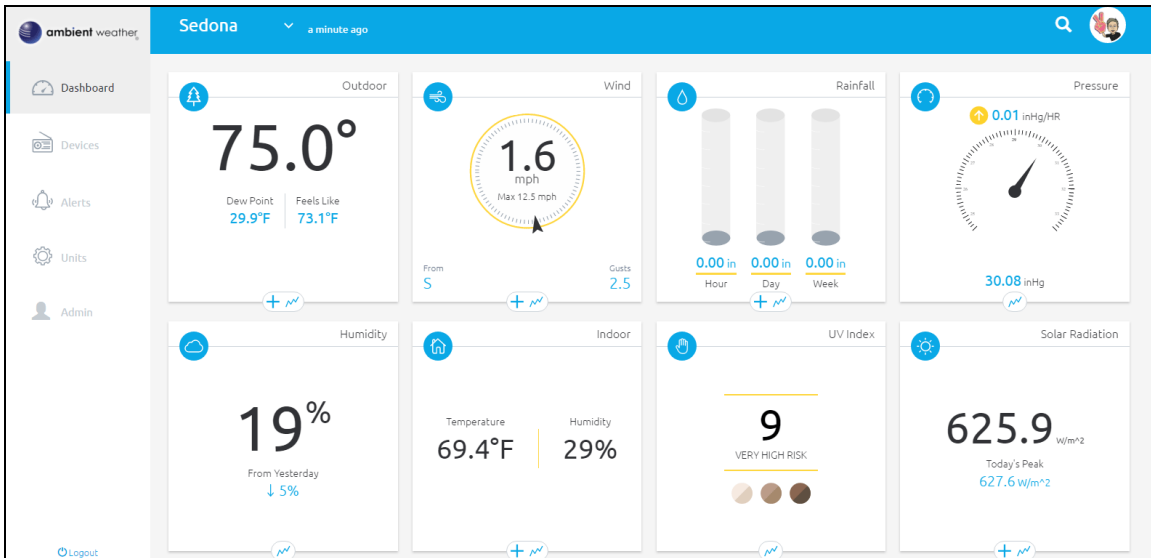


Figure 48

AmbientWeather.net is a responsive design and mobile friendly, so there is no need for a mobile app. Simply open your mobile devices web browser, browse to AmbientWeather.net, and bookmark your dashboard. If you save the bookmark to your desktop, it will automatically save the Ambient Weather icon, as shown in Figure 49.

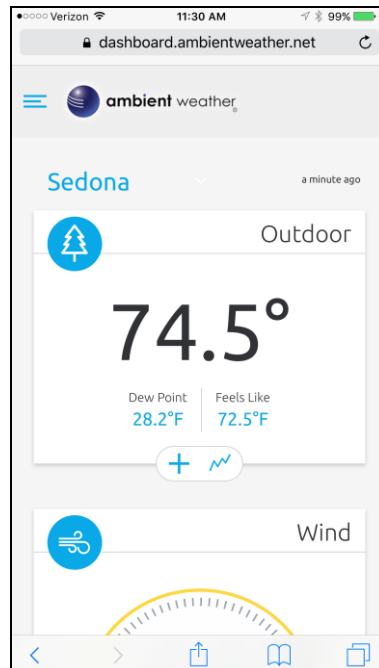


Figure 49

#### 6.4 Viewing your Data on Weather Underground

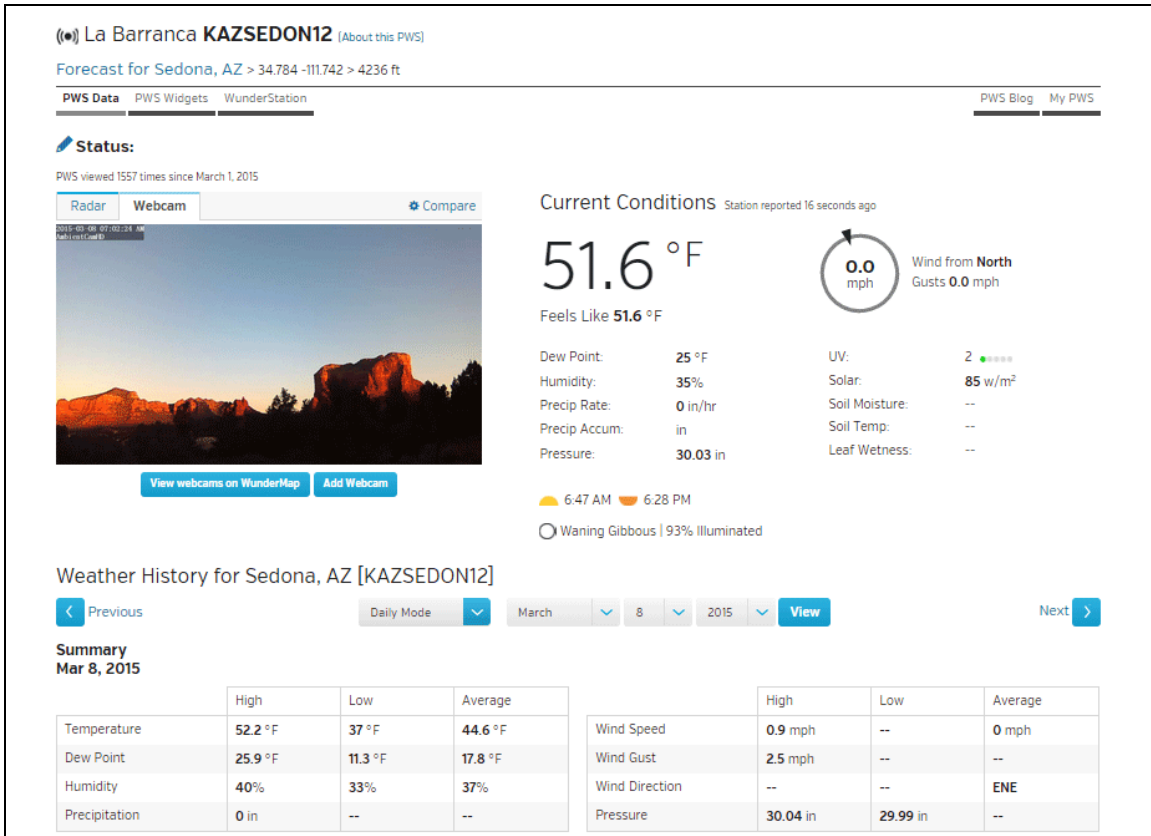
There are several ways to view your data on Wunderground:

### 6.4.1 Web Browser

Visit:

<http://www.wunderground.com/personal-weather-station/dashboard?ID=STATIONID>

where **STATIONID** is your personal station ID (example, KAZSEDON12).



**Figure 50**

### 6.4.2 WunderStation iPad Application

Visit:

<http://www.WunderStation.com>

to download the WunderStation iPad app.



**Figure 51**

### 6.4.3 Mobile Apps

Visit:

<http://www.wunderground.com/download/index.asp>

for a complete list of Mobile apps for iOS and Android. Alternately, you can find your data on your mobile device's web browser.



Figure 52

## 6.5 Additional AmbientWeather.net Features

### 6.5.1 IFTTT

The AmbientWeather.net service connects to IFTTT, the platform that allows devices and services to work together seamlessly.

Here are a few things you can do with IFTTT:

- Turn off your Rachio sprinklers when it rains, there is too much wind, or below freezing.
- Close your Hunter blinds when the sun is too intense.
- Close your garage door when it is too windy.
- Blink your hue lights when it starts raining.
- Connect to other web services, such as Gmail, Facebook, Instagram, or Pinterest.

For more information on IFTTT and how it can work for you, visit:

[https://ifttt.com/ambient\\_weather](https://ifttt.com/ambient_weather)

### 6.5.2 Compatible with Alexa

The Ambient Weather skill provides Ambient Weather personal weather station owners with the ability to get real-time, and past weather information generated by the devices they have set up at AmbientWeather.net.

Enable the skill and get started: say "Alexa, ask Ambient Weather for a weather report.". This will provide you with your outdoor weather report, but you can ask for your indoor weather report as well by saying, "Alexa, ask Ambient Weather about the indoor conditions." You can also ask for a report about a specific day, month or year! Just say "Alexa, ask Ambient Weather about the weather yesterday." or "Alexa, ask Ambient Weather about the weather in May".



---

For more information and to enable this skill, visit:

<https://www.amazon.com/dp/B074PGCM1D/>

### 6.5.3 Works with Google Assistant

The Ambient Weather Google Assistant app provides Ambient Weather personal weather station owners with the ability to get real-time, and past weather information generated by the devices they have set up at AmbientWeather.net

Link your account to get started: say 'hey google, Ambient Weather... weather report.' This will provide you with your outdoor weather report. You can ask for your indoor weather report as well by saying, 'indoor conditions'.

You can also link the Ambient Weather app by downloading the Google Assistant.

Here are some sample commands:


- Weather Report
- Outdoor conditions
- Indoor conditions
- Yesterdays weather
- Conditions for October 15, 2017
- Conditions for September 2017
- Conditions for 2016

For more information and to enable this app, visit:

<https://assistant.google.com/services/a/id/668e6f3369f27209/>

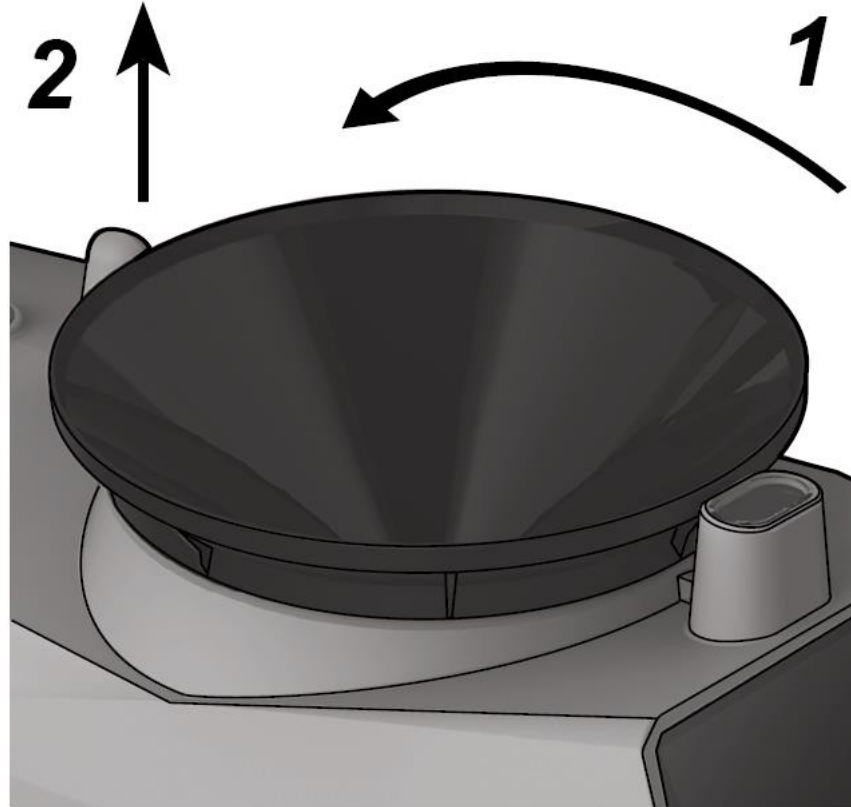
## 7 Maintenance

### 7.1 Battery Replacement

When the low battery indicator  is displayed, it indicates that the outdoor sensor or the current channel indoor sensor battery power is low, and the batteries need replacing.

### 7.2 Cleaning the Rain Collector

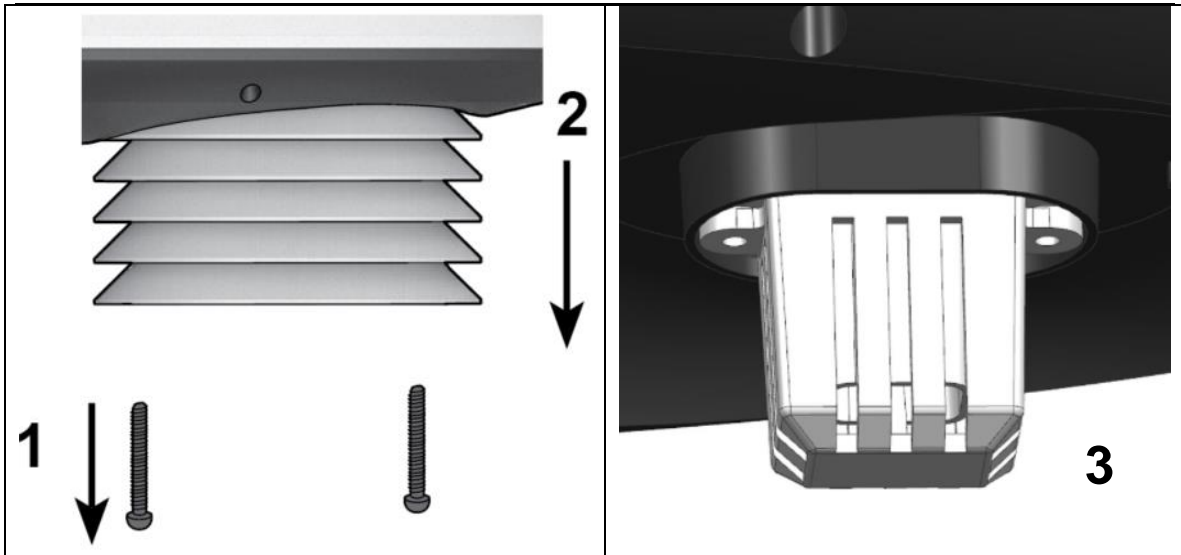
1. Unscrew the rain collector funnel by turning it 30° counter clockwise.
2. Gently remove the rain collector funnel.
3. Clean and remove any debris or insects.
4. Install the collector funnel after it has been cleaned and completely dried.



**Figure 53**

### **7.3 Cleaning the Outdoor Thermo-Hygrometer Sensor**

1. Remove the 2 screws at the bottom of the radiation shield.
2. Gently pull off the shield.
3. Carefully remove any dirt or insects on the sensor casing (Do not let the sensors inside get wet).
4. Clean the shield with a damp cloth to remove any dirt or insects.
5. Reinstall the shield when completely clean and dried.



**Figure 54**

#### 7.4 UV Sensor Calibration and Cleaning

The UV sensor lens must be periodically cleaned with a damp cloth.

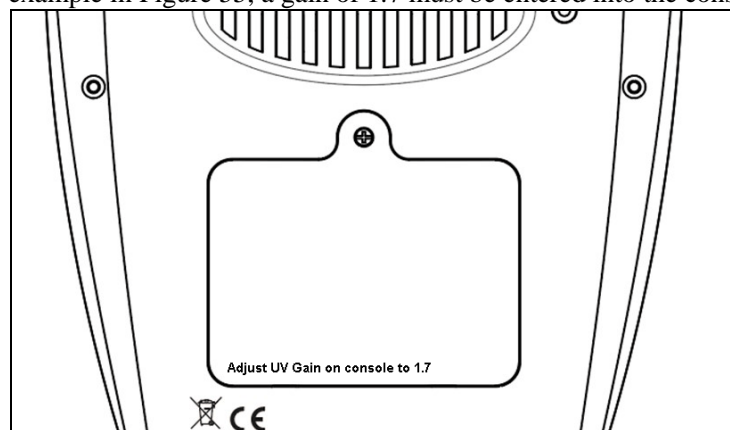
- 1 In normal mode, press and hold [ **INDEX** ] key for 8 seconds to enter UV index calibration mode
- 2 Use [ **GRAPH / Δ** ] or [ **°F / °C / V** ] key to adjust the UV gain up or down (the default is 1.0).
- 3 Press the [ **INDEX** ] key twice to confirm and exit this setting

**Note:**

The default UV gain magnification factor is 1.0, and can be adjusted up or down in increments of 0.1.

##### 7.4.1 Sensor Manufacturing Gain

The UV sensor manufacturer may have included a gain or adjustment for a specific sensor technology or build. Please reference your weather station battery compartment for any reference to gain adjustment. In the example in Figure 55, a gain of 1.7 must be entered into the console.



**Figure 55**

## 7.4.2 UV Sensor Degradation

Over time, the UV sensor will naturally degrade. The UV sensor can be calibrated with a utility grade UV meter.

## 7.5 Console Firmware Updates

To find the latest firmware updates, visit:

<https://ambientweather.net/help/ws-8478-firmware/>

1. Extract or unzip the update zip file.
2. Copy the extracted **update** folder to the USB stick. A typical USB stick is shown in Figure 56 (any memory size will do). Make sure the **update** folder is in the USB mass storage driver's root directory and it should be Fat 32 format, as shown in Figure 57.



Figure 56

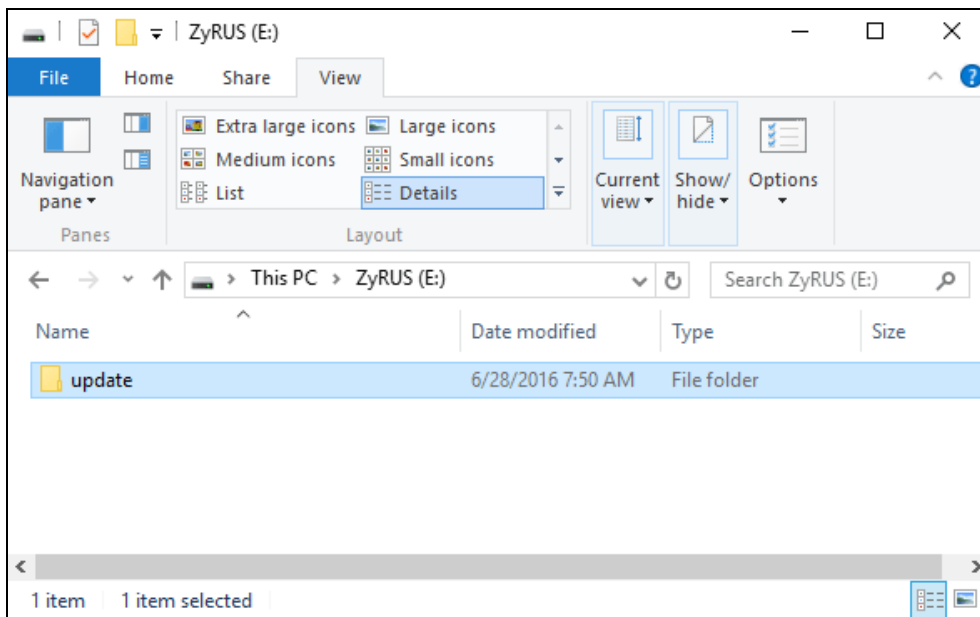


Figure 57

3. Disconnect the console's AC power from the power outlet and remove the backup batteries (you will lose all settings). Plug the USB stick into the USB port on the right side of the console.



Figure 58

4. Reconnect the console's AC power to start the update process (In the meantime, do not remove the USB stick)
5. During the update process the LCD will show the update status as shown in Figure 59.

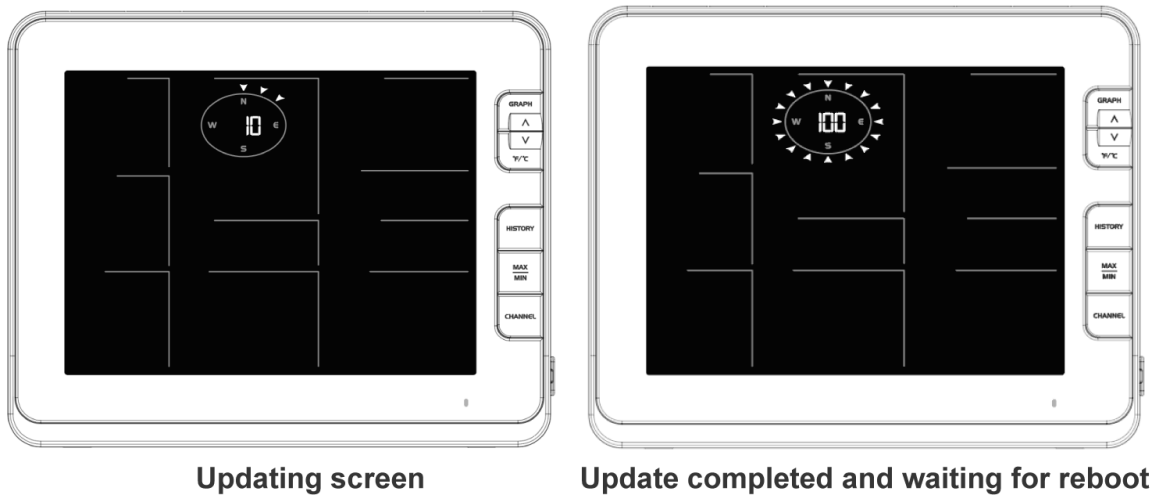


Figure 59

6. Once the update completed, the console will restart and return to the normal display screen.
7. Remove the USB mass storage driver form the main console.
8. Normally, the Wi-fi /server connection and time zone setting is permanently stored in the console. However, if the console is reset to factory default, please re-enter the information in Section 6.2.

## 8 Adding or Subtracting Multiple Sensors

If you add or subtract multiple sensors, you will need to synchronize the sensors.

### 8.1 Adding or Subtracting Sensors

1. Make sure each sensor is on a different channel and in sequence (1, 2, 3, ..) before powering up. Insert the batteries.  
If already powered up, press the reset button inside the battery compartment. Reference Section 3.3.2 for details.
2. Place each sensor about 5 to 10 feet from the console.
3. Press the **SENSOR** button on the back of the console to begin synchronization. Reference

Section 3.3.1 for details.

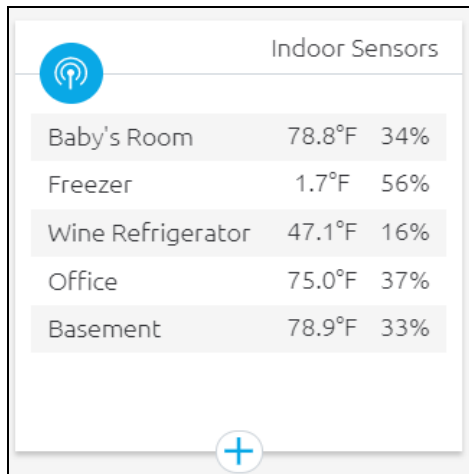
4. Do not touch any buttons until synchronization is complete.

## 8.2 Multiple Sensor Features

The console will scroll through the multiple channels, so there is no need to press the Channel button. Reference Section 5.8.3.2 for details.

Wunderground.com does not support multiple sensor channels. However, AmbientWeather.net does support multiple channels.

The AmbientWeather.net dashboard allows you to rename the sensor description, as shown in Figure 60.



Indoor Sensors		
Baby's Room	78.8°F	34%
Freezer	1.7°F	56%
Wine Refrigerator	47.1°F	16%
Office	75.0°F	37%
Basement	78.9°F	33%

Figure 60

## 9 Specifications

### 9.1 Wireless Specifications

- Indoor Thermo-Hygrometer: 300 feet line of sight, 100 feet under most conditions.
- Outdoor Sensor Array: 300 feet line of sight, 100 feet under most conditions.
- Frequency: 915 MHz
- Update Rate: Wind Speed and Direction: 12 seconds. All other outdoor parameters: 24 seconds, indoor parameters: 60 seconds

## 9.2 Measurement Specifications

The following table provides specifications for the measured parameters.

Measurement	Range	Accuracy	Resolution
Indoor and Outdoor Temperature	-4 to 140 °F alkaline batteries  -40 to 140 °F Lithium e2 Energizer batteries	131 to 140°F: ± 0.9°F (55 to 60°C: ± 0.5°C)  50 to 131°F: ± 0.7°F (10 to 55°C: ± 0.4°C)  - 4 to 50°F: ± 2.3°F (-20 to 10°C: ± 1.3°C)  - 40 to - 4°F: ± 3.4°F (-40 to -20°C: ± 1.9°C)	0.1 °F/°C
Indoor and Outdoor Humidity	0 to 100%	0 to 90% RH ± 2.5% RH @ 77°F (25°C)  90 to 100% RH ± 3.5% RH @ 77°F (25°C)	1%
Barometer	Altitude Range: -2288 to 16,416 feet (-697 to 5000 meters)  Barometer Range: 15.94 to 32.48 inHg (540hPa to 1100hPa)	20.67 to 32.48 inHg: ±0.15inHg (700 to 1100hPa: ± 5hPa)  15.94 to 20.67 inHg: ± 0.24inHg (540 to 700hPa: ± 8hPa)  typical at 77°F (25°C)	1hPa / 0.01inHg / 0.1mmHg
Wind Speed	0 to 112mph (50m/s, 180km/h, 97knots)	± 10%	0.1mph, 0.1m/s, 0.1km/h, 0.1knots
Wind Direction	0 to 360°	± 3°	1°
Rain	0 to 787.3 in (0 to 19999mm)	± 7%	0.01 in (0.254 mm)
UV	0 to 16	±1 UVI	1

## 9.3 Power Consumption

- Display backup power: 3 x AAA Alkaline Batteries (not included)
- Display: DC 5V, 1.0A 100-240V 50 / 60 Hz UL rated Class 5 adaptor
- Indoor Thermo-Hygrometer Sensor: 2 x AA Alkaline batteries (not included)
- Outdoor Sensor Array: 3 x AA Alkaline batteries recommended, Lithium e2 Energizer for cold weather.
- Outdoor Sensor Array: Solar Panel

## 9.4 WiFi Specifications

- WIFI Standard: 802.11 b/g/n
- Wi-Fi Operating frequency: 2.4G
- Setup User Interface (UI) support setup device: Build-in WiFi with WAP mode smart device, including laptops, computers, smart phones and smart pads.
- Recommend web browser for setup UI: Web browser support of HTML 5, such as the latest versions of Chrome, Safari, IE, Edge, Firefox or Opera.

### **9.5 Other Specifications**

- Time synchronize method: Synchronized through internet UTC time server
- Console Temperature Limits of Operation: 23 °F to 122 °F (-5°C to 50°C)

### **9.6 Weight Specifications**

- Console: 1.3 lbs (590 grams) with batteries
- Sensor Array: 2.4 lbs (1096 grams) with batteries
- Indoor Sensor: 0.32 lbs (144 grams) with batteries

## **10 Troubleshooting Guide**

If your question is not answered here, you can contact us as follows:

1. Email Support: [support@ambientweather.com](mailto:support@ambientweather.com)
2. Technical Support: 480-346-3380 (M-F 8am to 3pm Arizona Time). Note that Arizona does not observe Daylight Savings Time.



Problem	Solution
The wireless sensor communication has been lost or is intermittent or will not sync up.	<ul style="list-style-type: none"> <li>• Make sure the transmitter is powered up and the LED is flashing about once per 12 seconds. For cold weather environments, install lithium batteries. If the transmitter is not flashing, replace the batteries.</li> <li>• Resync the console. Reference Section 3.4.2.</li> <li>• The maximum line of sight communication range is 300'. Move the sensor closer to the console.</li> <li>• If the sensor array is too close (less than 5-10'), move the sensor away from the console.</li> <li>• Make sure the remote sensors are not transmitting through solid metal (acts as an RF shield), or earth barrier (down a hill).</li> <li>• Move the console away from electrical noise generating devices, such as computers, TVs and other wireless transmitters or receivers.</li> <li>• Radio Frequency (RF) Sensors cannot transmit through metal barriers (example, aluminum siding) or multiple, thick walls.</li> </ul>
The console does not respond to commands.	<ul style="list-style-type: none"> <li>• Press the reset button on the back of the console with an open ended paper clip or sharp tool.</li> </ul>
Cannot connect the console to WiFi	<ul style="list-style-type: none"> <li>• Check your WiFi password is correct.</li> <li>• Make sure your device (desktop, laptop, tablet or phone) is connected to your WiFi router.</li> <li>• If you own a dual band router (2.4 and 5 GHz), make sure your WiFi 2.4 GHz band is turned on.</li> </ul>
AmbientWeather.net is not updating	<ul style="list-style-type: none"> <li>• Make sure your MAC address was entered correctly.</li> <li>• Make sure the checkbox is checked in the web panel (reference Figure 43).</li> </ul>
Wunderground.com is not updating	<ul style="list-style-type: none"> <li>• Make sure the checkbox is checked in the web panel (reference Figure 43).</li> <li>• Make sure your station ID and Station Key are correct (reference Figure 46).</li> <li>• DO NOT copy and paste your station key into the console's web display, as it will add a lagging space. Make sure you type it in. Also, it is easy to confuse the lower case letter l, upper case I and the number 1, as well as the number 0 and the letter O.</li> </ul>
Console Sunrise and Sunset is not correct	Make sure your longitude, latitude (reference Figure 43), time zone and Daylight Savings Time are set properly (Reference Section 5.1.1).

<b>Problem</b>	<b>Solution</b>
Console Time is off by increments of hours.	Make sure your time zone and Daylight Savings Time are set properly (Reference Section 5.1.1).

## 11 Liability Disclaimer

Please help in the preservation of the environment and return used batteries to an authorized depot. The electrical and electronic wastes contain hazardous substances. Disposal of electronic waste in wild country and/or in unauthorized grounds strongly damages the environment.

Reading the “User manual” is highly recommended. The manufacturer and supplier cannot accept any responsibility for any incorrect readings and any consequences that occur should an inaccurate reading take place.

This product is designed for use in the home only as indication of weather conditions. This product is not to be used for medical purposes or for public information.

The specifications of this product may change without prior notice.

This product is not a toy. Keep out of the reach of children.

No part of this manual may be reproduced without written authorization of the manufacturer.

Ambient, LLC WILL NOT ASSUME LIABILITY FOR INCIDENTAL, CONSEQUENTIAL, PUNITIVE, OR OTHER SIMILAR DAMAGES ASSOCIATED WITH THE OPERATION OR MALFUNCTION OF THIS PRODUCT.

## 12 FCC Statement

### Statement according to FCC part 15.19:

This device complies with part 15 of the FCC rules. Operation is subject to the following two conditions:

1. This device may not cause harmful interference.
2. This device must accept any interference received, including interference that may cause undesired operation.

### Statement according to FCC part 15.21:

Modifications not expressly approved by this company could void the user's authority to operate the equipment.

### Statement according to FCC part 15.105:

NOTE: This equipment has been tested and found to comply with the limits for a Class B digital device, pursuant to Part 15 of the FCC Rules. These limits are designed to provide reasonable protection against harmful interference in a residential installation. This equipment generates, uses and can radiate radio frequency energy and, if not installed and used in accordance with the instructions, may cause harmful interference to radio communications.

However, there is no guarantee that interference will not occur in a particular installation. If this equipment does cause harmful interference to radio or television reception, which can be determined by turning the equipment off and on, the user is encouraged to try to correct the interference by one or more of the following measures:

- Reorient or relocate the receiving antenna.
- Increase the separation between the equipment and receiver.
- Connect the equipment into an outlet on a circuit different from that to which the receiver is connected.

- 
- Consult the dealer or an experienced radio/TV technician for help.

The Responsible party:

Company Name: Ambient, LLC

Address : 6845 W. Frye Road Chandler, AZ 85226

Phone : 1-(480)346-3380

### 13 Warranty Information

Ambient, LLC provides a 1-year limited warranty on this product against manufacturing defects in materials and workmanship.

This limited warranty begins on the original date of purchase, is valid only on products purchased and only to the original purchaser of this product. To receive warranty service, the purchaser must contact Ambient, LLC for problem determination and service procedures.

Warranty service can only be performed by an Ambient, LLC. The original dated bill of sale must be presented upon request as proof of purchase to Ambient, LLC.

Your Ambient, LLC warranty covers all defects in material and workmanship with the following specified exceptions: (1) damage caused by accident, unreasonable use or neglect (lack of reasonable and necessary maintenance); (2) damage resulting from failure to follow instructions contained in your owner's manual; (3) damage resulting from the performance of repairs or alterations by someone other than an authorized Ambient, LLC authorized service center; (4) units used for other than home use (5) applications and uses that this product was not intended (6) the products inability to receive a signal due to any source of interference or metal obstructions and (7) extreme acts of nature, such as lightning strikes or floods.

This warranty covers only actual defects within the product itself, and does not cover the cost of installation or removal from a fixed installation, normal set-up or adjustments, claims based on misrepresentation by the seller or performance variations resulting from installation-related circumstances.

