Ambient Weather WS-1001-WiFi OBSERVER Solar Powered Wireless WiFi Weather Station User Manual



Table of Contents

1.	Introduction	2
2.	Warnings and Cautions	2
3.	Quick Start Guide.....	2
4.	Pre-Installation Checkout and Site Survey.....	3
4.1	Pre Installation Checkout	3
4.2	Site Survey	3
5.	Getting Started	3
5.1	Parts List.....	4
5.2	Recommend Tools.....	5
5.3	Sensor Array Set Up.....	6
5.3.1	Install Wind Vane	7
5.3.2	Install Mounting Pole	7
5.3.3	Install Batteries.....	9
5.3.4	Mount Weather Station.....	11
5.3.5	Reset Button and Transmitter LED	13
5.4	Indoor Thermo-Hygrometer-Barometer Transmitter.....	14
5.5	Best Practices for Wireless Communication	15
5.6	Display Console	15
6.	Display Console Operation	16
6.1	Home Screen Display	16
6.2	History Mode.....	17
6.2.1	Archive Memory Mode.....	18
6.2.2	Recall / Delete Annual Archive Memory	19
6.2.3	Page Selection	20
6.2.4	Historical Graphs	21
6.3	Set Mode	23
6.3.1	Set Date and Time	23
6.3.2	Set Time Format.....	25
6.3.3	Temperature Units of Measure	25
6.3.4	Barometer Units of Measure	25
6.3.5	Wind Speed Units of Measure.....	25
6.3.6	Rainfall Units of Measure	25
6.3.7	Solar Radiation Units of Measure	25
6.3.8	Rainfall Display Increments.....	25
6.3.9	Graph Time	26
6.3.10	Backlight Display.....	26
6.3.11	Longitude and Latitude	26
6.3.12	Barometer Display	28
6.3.13	Weather Threshold	29
6.3.14	Storm Threshold.....	29
6.3.15	Current Weather	29
6.3.16	Rainfall Season	29
6.3.17	Archive Interval	29

6.3.18	Weather Server	29
6.3.19	WiFi Scan.....	32
6.4	Alarm Mode	32
6.5	Calibration Mode.....	33
6.6	Factory Default.....	37
6.6.1	Exporting Data File Format (Data Logging).....	40
7.	Glossary of Terms	41
8.	Specifications.....	43
8.1	Wireless Specifications	43
8.2	Measurement Specifications.....	43
8.3	Power Consumption	43
9.	Maintenance.....	44
9.1	Advanced Rain Gauge Cleaning	44
10.	Troubleshooting Guide.....	46
11.	Accessories.....	48
12.	Liability Disclaimer.....	48
13.	FCC Statement.....	48
14.	Warranty Information	49

1. Introduction

Thank you for your purchase of the Ambient Weather WS-1000-WiFi OBSERVER Solar Powered Wireless WiFi Weather Station. The following user guide provides step by step instructions for installation, operation and troubleshooting. To download the latest manual and additional troubleshooting tips, please visit:

<http://ambientweather.wikispaces.com/ws1001-wifi>

2. Warnings and Cautions

 **Warning:** Any metal object may attract a lightning strike, including your weather station mounting pole. Never install the weather station in a storm.

 **Warning:** Installing your weather station in a high location may result in injury or death. Perform as much of the initial check out and operation on the ground and inside a building or home. Only install the weather station on a clear, dry day.

3. Quick Start Guide

Although the manual is comprehensive, much of the information contained may be intuitive. In addition, the manual does not flow properly because the sections are organized by components.

The following Quick Start Guide provides only the necessary steps to install, operate the weather station, and upload to the internet, along with references to the pertinent sections.

Required		
Step	Description	Section
1	Assemble and power up the sensor array	5.3.1 - 5.3.3
2	Power up the indoor thermometer-hygrometer-barometer	5.4
3	Power up the display console and synchronize with sensor array and thermo-hygrometer-barometer	5.6
6	Mount the sensor array	5.3.4
4	Set date and time on console	6.3.1
5	Calibrate the relative pressure to sea-level conditions (local airport) on console	6.5
7	Reset the rain to zero on console	6.5
Optional		
8	Configure WiFi	6.3.19
9	Register and upload to Weather Server	6.3.18

4. Pre-Installation Checkout and Site Survey

4.1 Pre Installation Checkout

Before installing your weather station in the permanent location, we recommend operating the weather station for one week in a temporary location with easy access. This will allow you to check out all of the functions, insure proper operation, and familiarize you with the weather station and calibration procedures. This will also allow you to test the wireless range of the weather station.

4.2 Site Survey

Perform a site survey before installing the weather station. Consider the following:

1. You must clean the rain gauge every few months and change the rechargeable batteries every 2-3 years. Provide easy access to the weather station.
2. Avoid radiant heat transfer from buildings and structures. In general, install the sensor array at least 5' from any building, structure, ground, or roof top.
3. Avoid wind and rain obstructions. The rule of thumb is to install the sensor array at least four times the distance of the height of the tallest obstruction. For example, if the building is 20' tall, and the mounting pole is 6' tall, install $4 \times (20 - 6) = 56'$ away.
4. Wireless Range. The radio communication between receiver and transmitter in an open field can reach a distance of up to 330 feet, providing there are no interfering obstacles such as buildings, trees, vehicles, high voltage lines. Wireless signals will not penetrate metal buildings. Under most conditions, the maximum wireless range is 100'.
5. Radio interference such as PCs, radios or TV sets can, in the worst case, entirely cut off radio communication. Please take this into consideration when choosing console or mounting locations. Make sure your display console is at least five feet away from any electronic device to avoid interference.
6. Visit Ambient Weather Mounting Solutions for assistance and ideas for mounting your weather station:

<http://www.ambientweather.com/amwemoso.html>





5. Getting Started

The WS-1000-WiFi weather station consists of a display console (receiver), an all in one sensor array,

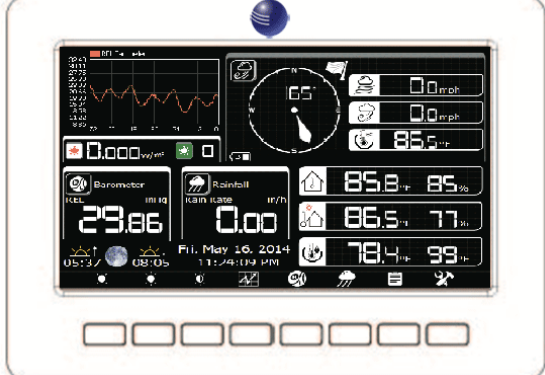
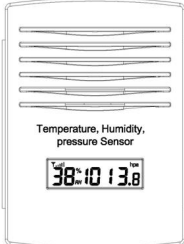
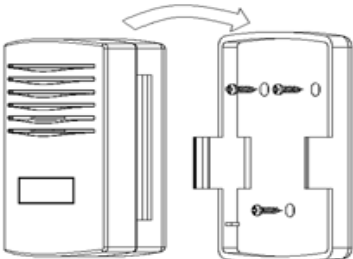
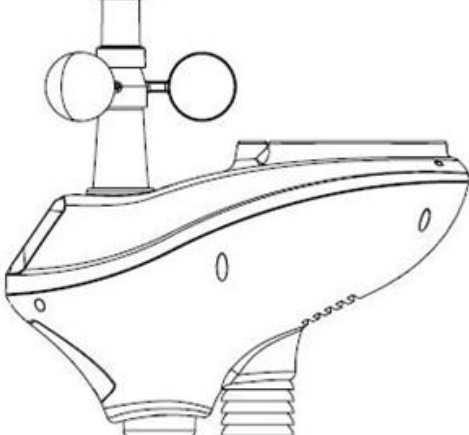
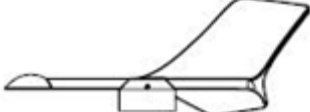
and wireless thermo-hygrometer-barometer.

5.1 Parts List

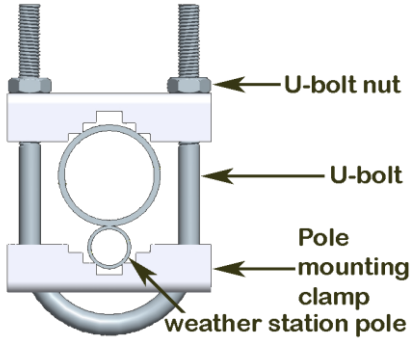
QTY	Item	Image
1	Display Console Frame Dimensions (LxWxH): 7.75 x 5.75 x 0.75" LCD Dimensions (LxW): 6.25 x 3.5"	
1	Thermo-hygrometer-barometer transmitter	
1	Thermo-hygrometer-barometer mounting bracket plus 3 mounting screws	
1	Sensor Array	
1	Wind Vane	

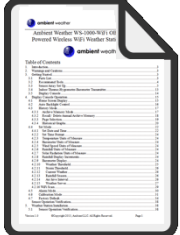
QTY	Item	Image
1	5V DC Adaptor	
2	Pole (straight and crimped)	
2	Pole mounting U-bolt	
4	Pole mounting clamps	
4	Pole mounting U-bolt nuts	
1	Allen wrench	
1	User manual	

5.2 Recommend Tools

- Precision screwdriver (for small Phillips screw on battery cover door)
- Adjustable wrench (for mounting pole)
- Compass or GPS (for wind direction calibration)

5.3 Sensor Array Set Up

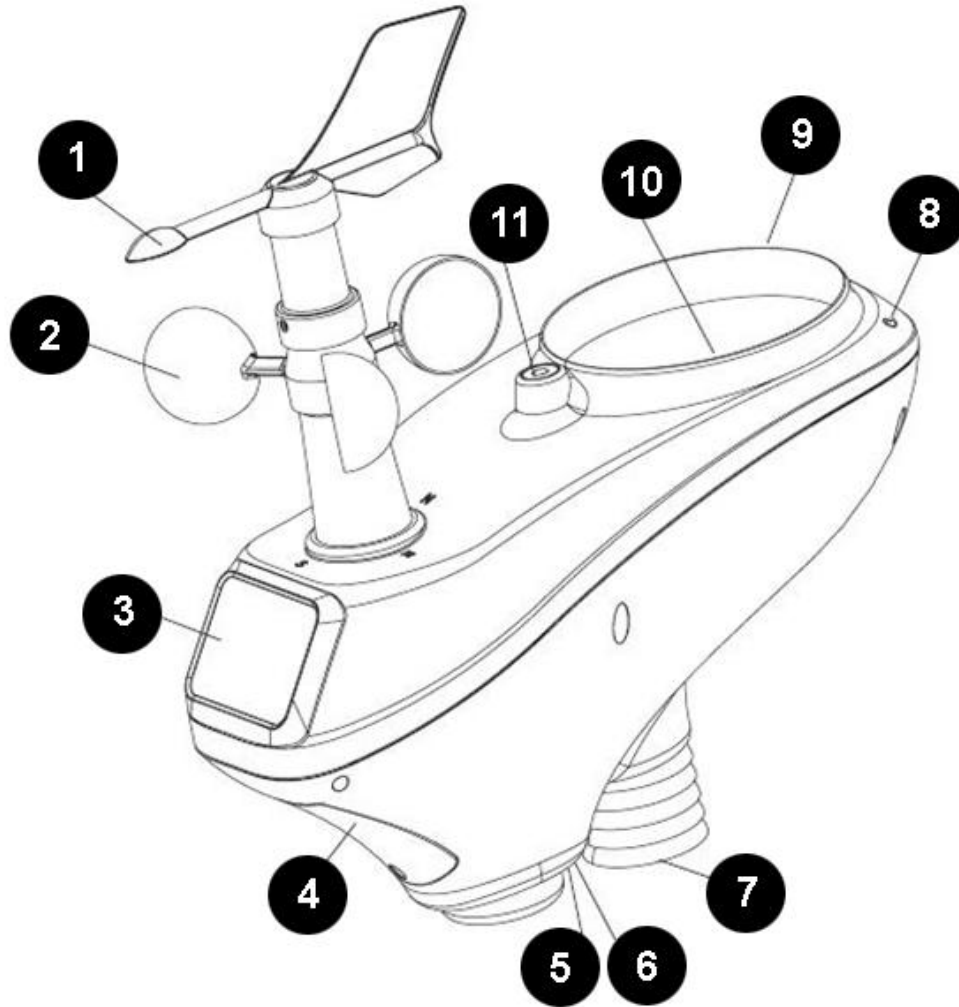

Figure 1

No	Description	No	Description
1	Wind Vane (measures wind direction)	7	Thermo-hygrometer Sensor (measures temperature and humidity)
2	Wind Speed Sensor (measures wind speed)	8	UV Sensor
3	Solar collector	9	Solar Radiation Sensor
4	Rechargeable battery compartment	10	Rain Collector (self emptying)
5	LED transmission indicator (turns on for 4 seconds on power up, flashes once per 16 seconds)	11	Bubble Level
6	Reset button		

5.3.1 Install Wind Vane

Reference Figure 2. (a) Locate and align the flat key on the wind vane shaft to the flat key on the wind vane and push the vane on to the shaft. (b) tighten the set screw with the hex wrench (included).

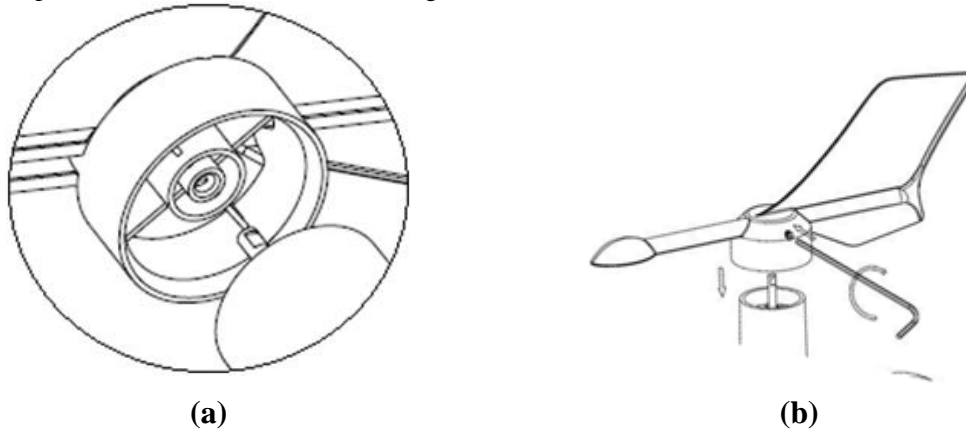

Figure 2

5.3.2 Install Mounting Pole

Reference Figure 3. Remove the mounting pole collar by rotating counter clockwise.

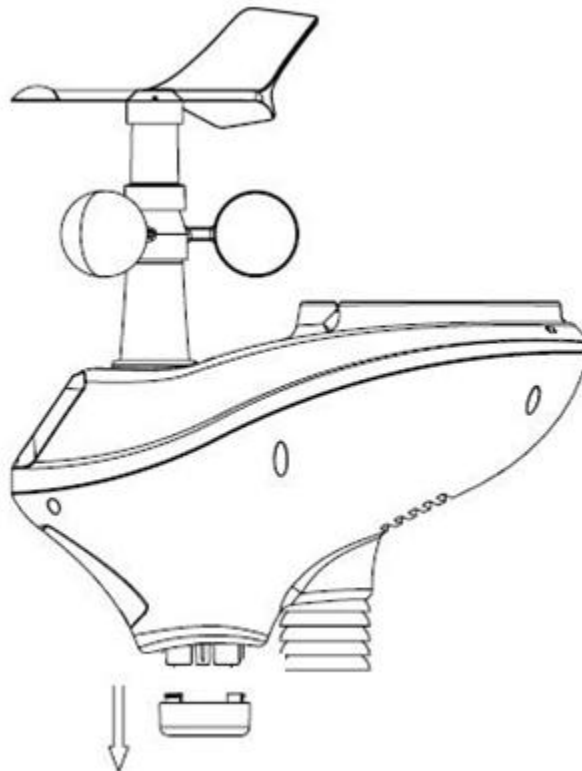

Figure 3

Reference Figure 4. Locate and align the groove on the sensor array and mounting pole.

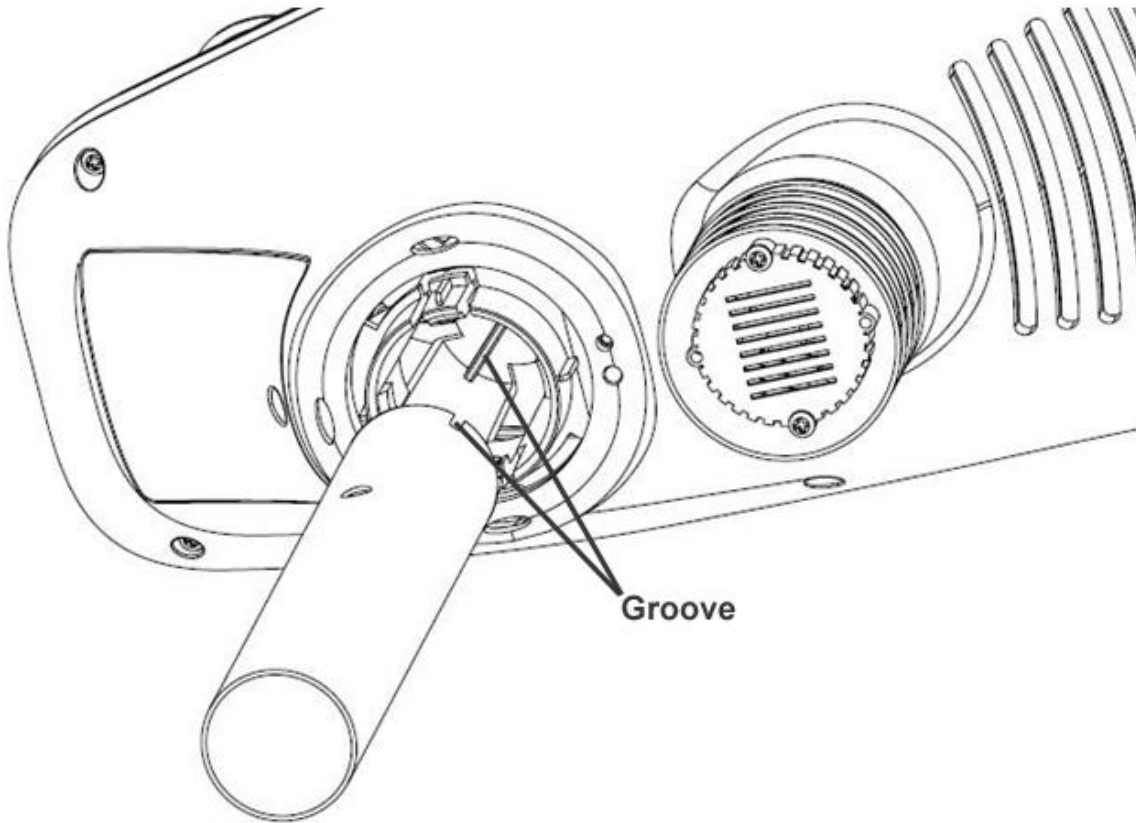

Figure 4

Reference Figure 5. Turn the mounting pole collar to lock the pole into place by rotating clockwise.

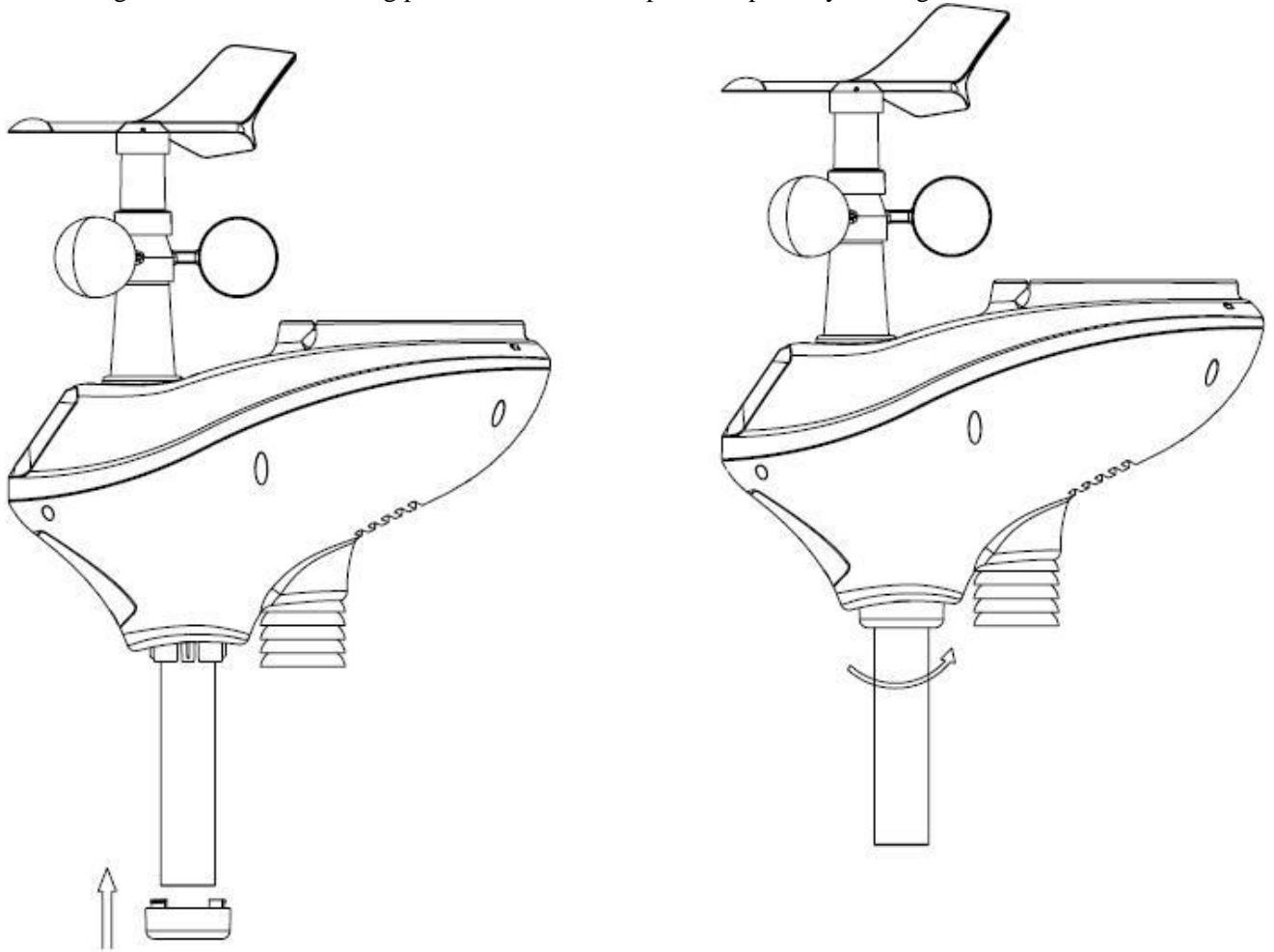

Figure 5

5.3.3 Install Batteries

Reference Figure 6. Locate the battery door on the bottom of the sensor array. Turn the set screw counter clockwise to open the battery compartment. Insert the 3xAA rechargeable batteries (included). The LED indicator on the bottom of the sensor array will turn on for four seconds and normally flash once per 16 seconds (the transmission update period).

Close the battery door and tighten the set screw.

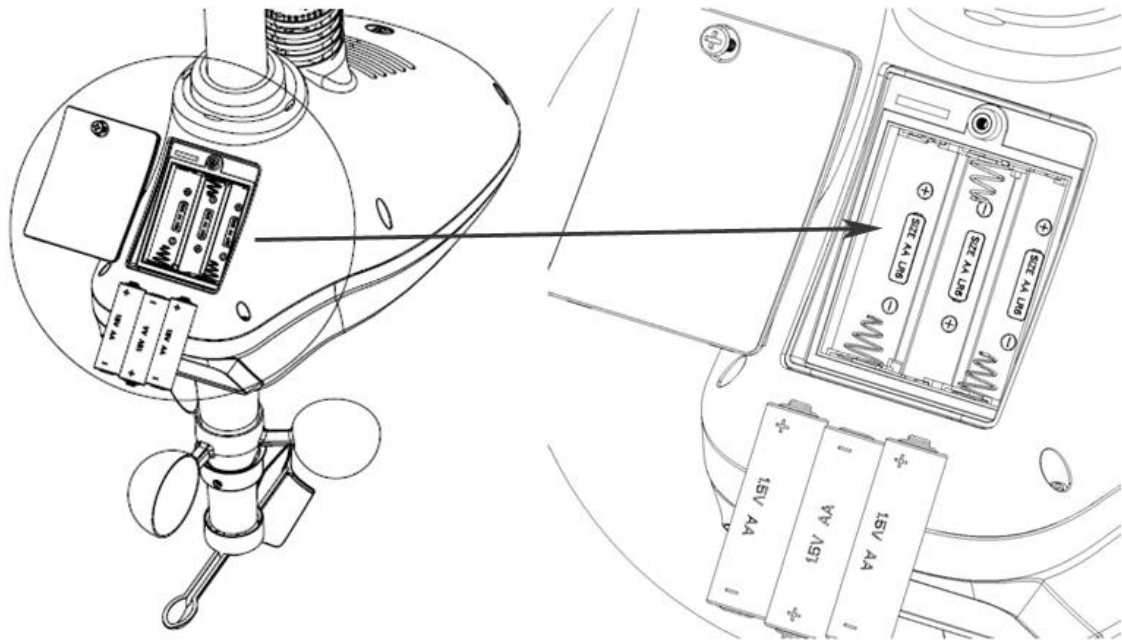

Figure 6

5.3.4 Mount Weather Station

There are two methods for attaching your weather station:

A. Option 1: Mounting Clamps. Fasten the mounting pole to your mounting pole or bracket (purchased separately) with the two U-bolts, mounting pole brackets and nuts, as shown in Figure 7. Tighten the mounting pole to your mounting pole with the U-Bolt assembly. Make sure your mounting pole is as far away from the temperature sensor as possible, as shown in Figure 7.

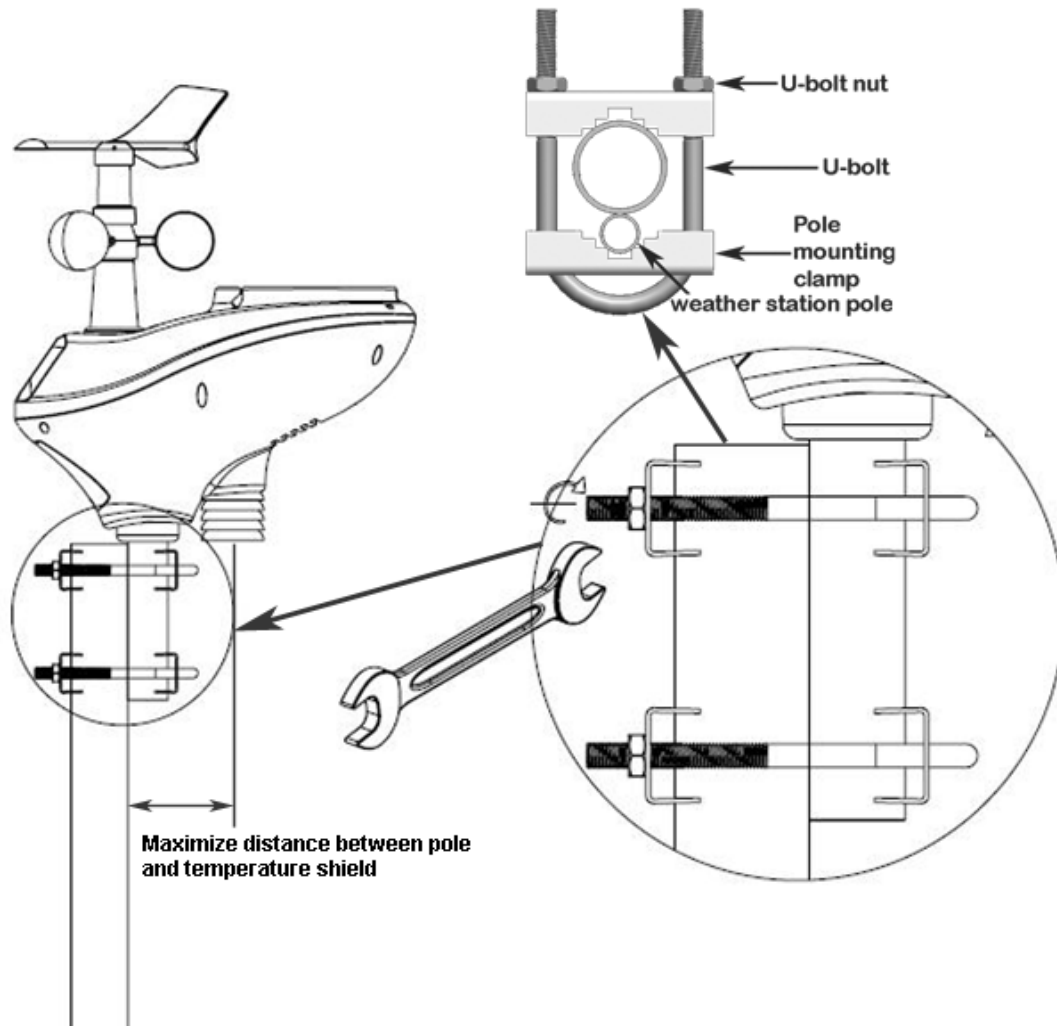

Figure 7

B. Option 2: Swedged Pole Mount. Insert the swedged end of the included mounting pole into the open end of any standard mounting pole solution (1 3/8" diameter) available from Ambient Weather, as shown in Figure 8. For more information on mounting solutions, visit:

<http://www.ambientweather.com/amwemoso.html>

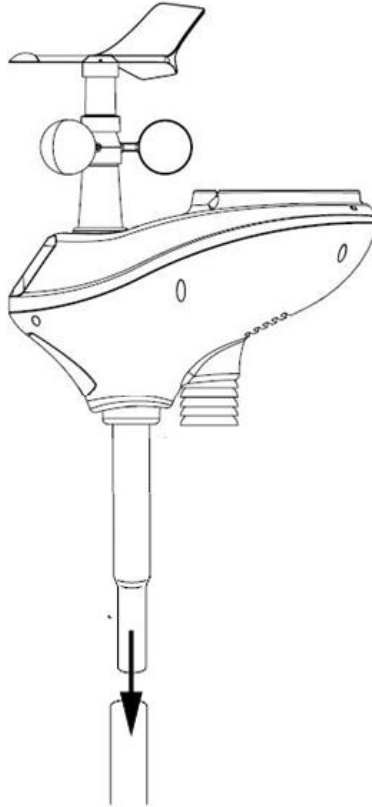

Figure 8

1. Reference Figure 9. Locate the four wind vane compass rose indicators of N, E, S, W (representing North, East, South and West). Align the compass rose direction upon final installation with a compass or GPS.

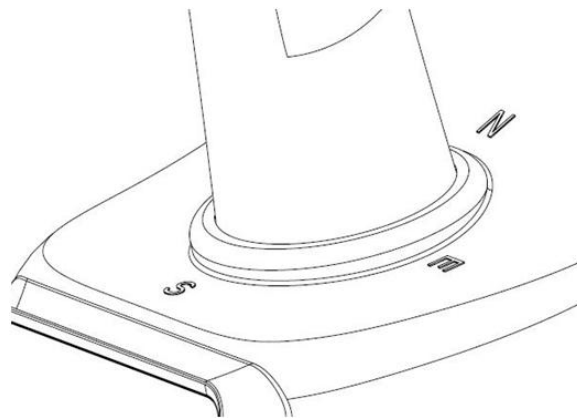

Figure 9

2. Reference Figure 10. Make sure the sensor array is completely level upon final installation. Failure to do so will result in inaccurate rain gauge readings.

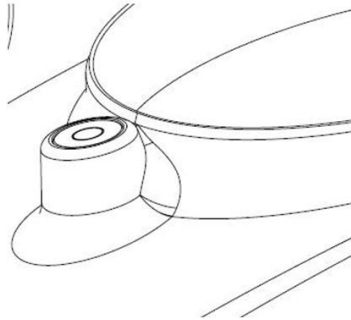

Figure 10

5.3.5 Reset Button and Transmitter LED

In the event the sensor array is not transmitting, reset the sensor array.

With an open ended paperclip, press and hold the **RESET BUTTON** for three seconds to completely discharge the voltage.

Take out the batteries and wait one minute, while covering the solar panel to drain the voltage.

Put batteries back in and resynchronize with console by powering down and up the console with the sensor array about 10 feet away.

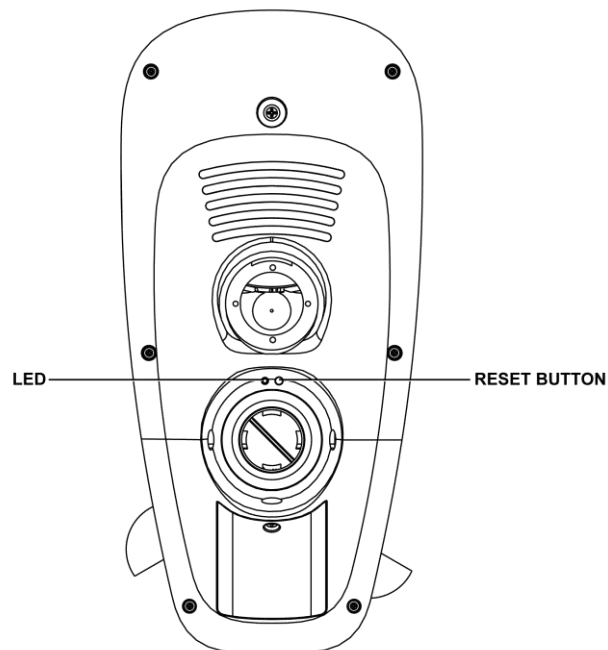

Figure 11

5.4 Indoor Thermo-Hygrometer-Barometer Transmitter

The indoor thermometer, hygrometer and barometer measures and displays the indoor temperature, humidity and pressure and transmits this data to the display console.

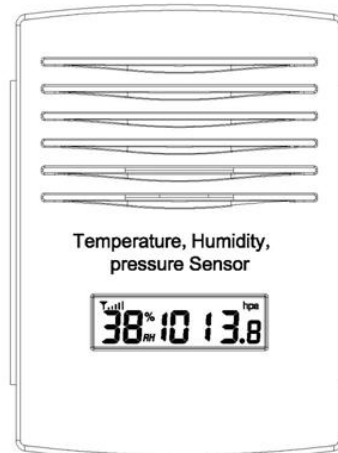





Figure 12

 **Note:** Do not install the thermo-hygrometer-barometer transmitter outside. This will cause errors in the barometric pressure due to large variations in temperature (barometric pressure is temperature compensated for accuracy). Note that pressure readings made inside your home, business, or facility will correspond closely to the actual barometric pressure outside.

 **Note:** The thermo-hygrometer-transmitter transmits directly to the display console. For best results, place between 5 to 20 feet from the display console.

 **Note:** To avoid permanent damage, please take note of the battery polarity before inserting the batteries.

Remove the battery door on the back of the sensor with a Philips screwdriver (there is only one screw, at the bottom of the unit). Insert two AAA batteries, as shown in Figure 13.

Replace the battery door and set screw. Note that the temperature, humidity and barometric pressure will be displayed on the LCD display. Looking at the back of the unit from left to right, the polarity is (-) (+) for the top battery and (+) (-) for the bottom battery.



Figure 13

5.5 Best Practices for Wireless Communication

 **Note:** To insure proper communication, mount the remote sensor(s) upright on a vertical surface, such as a wall. **Do not lay the sensor flat.**

Wireless communication is susceptible to interference, distance, walls and metal barriers. We recommend the following best practices for trouble free wireless communication.

1. **Electro-Magnetic Interference (EMI).** Keep the console several feet away from computer monitors and TVs.
2. **Radio Frequency Interference (RFI).** If you have other 433 MHz devices and communication is intermittent, try turning off these other devices for troubleshooting purposes. You may need to relocate the transmitters or receivers to avoid intermittent communication.
3. **Line of Sight Rating.** This device is rated at 300 feet line of sight (no interference, barriers or walls) but typically you will get 100 feet maximum under most real-world installations, which include passing through barriers or walls.
4. **Metal Barriers.** Radio frequency will not pass through metal barriers such as aluminum siding. If you have metal siding, align the remote and console through a window to get a clear line of sight.

The following is a table of reception loss vs. the transmission medium. Each “wall” or obstruction decreases the transmission range by the factor shown below.

Medium	RF Signal Strength Reduction
Glass (untreated)	5-15%
Plastics	10-15%
Wood	10-40%
Brick	10-40%
Concrete	40-80%
Metal	90-100%

5.6 Display Console

Connect the display console power jack to AC power with the power adapter (included), as shown in Figure 14.

Place the sensor array and indoor thermo-hygrometer transmitter about 5 to 10 feet from the display console and wait several minutes for the remote sensors to synchronize with the display console.

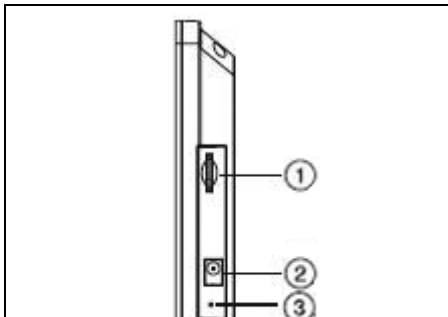
	No	Description
	1	Memory card slot for upgrades and backup data
2	Power jack	

	3	Reset
--	---	-------

Figure 14

6. Display Console Operation

 **Note: About This Section.** The display console includes buttons at the bottom with icons signifying the menu functions. This manual includes “quick menu boxes” as shown below, signifying how to access a setting from home screen. For example, to access Recall and delete annual archive memory, from the home screen, press the History Key twice and the recall page key once:



“Menu box” example. From the home screen, press the History Key twice and the recall page key once.

6.1 Home Screen Display

The display console home screen layout is shown in Figure 15.

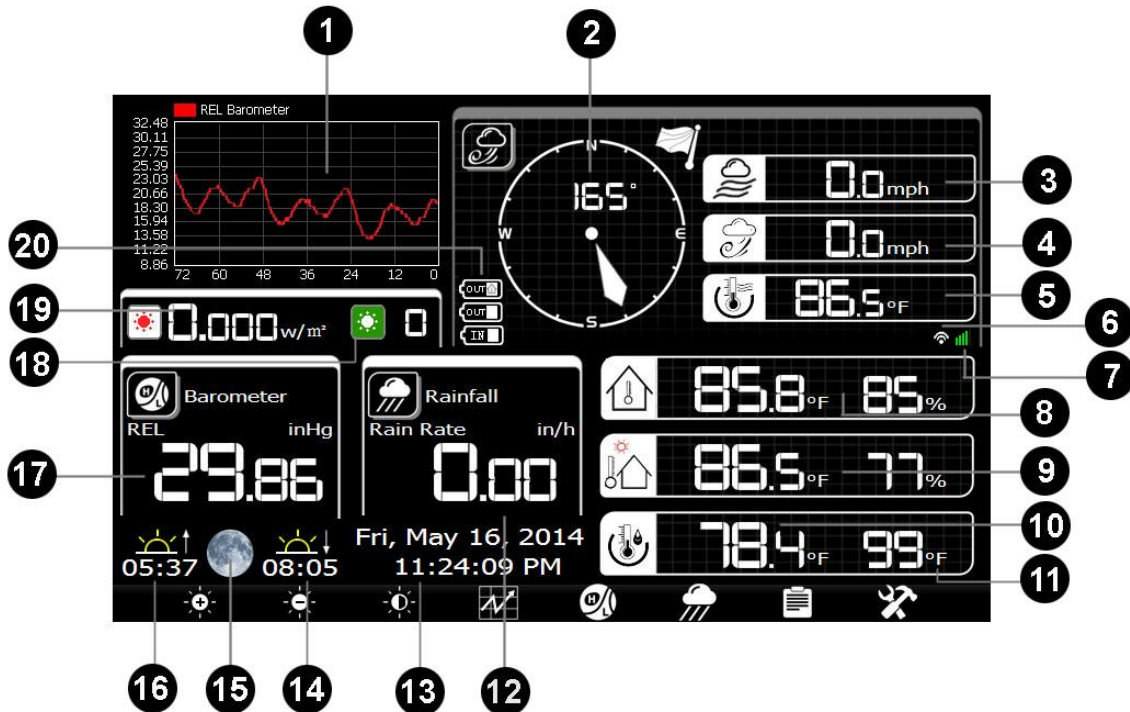









Figure 15

No	Description	No	Description
1	Graph (barometer, temperature or humidity)	11	Heat Index
2	Wind Direction	12	Rainfall
3	Wind Speed	13	Date and Time
4	Wind Gust	14	Sunset
5	Wind Chill	15	Moon Phase
6	Internet Connectivity	16	Sunrise
7	WiFi Connectivity	17	Barometer
8	Indoor Temperature & Humidity	18	UV
9	Outdoor Temperature & Humidity	19	Solar Radiation
10	Dew Point	20	Low Battery Indicators (only displayed when batteries are low) IN – Indoor Thermo-hygrometer-barometer transmitter OUT – Outdoor Sensor Array

Icon	Description
	Brightness control key Press this key to enhance the brightness
	Brightness control key Press this key to decrease the brightness
	Backlight on/off key Press this key to turn on/off the display
	Graph display key Press this key to choose between barometric pressure, indoor and outdoor temperature and indoor and outdoor humidity
	Pressure display key Press this key to choose the display between Absolute pressure and Relative pressure.
	Rain key Press this key to Shift the display between Rain Rate, Rain Day, Rain Week, Rain Month, and Rain Year.
	History key Press this key to enter History Mode
	Set key Press this key to enter Set Mode

6.2 History Mode











	View and reset minimum and maximums.
-------------------------------------------------------------------------------------	--------------------------------------



Figure 16

						
Check parameter to clear	Uncheck parameter to clear	Clear selected parameter.(1)	scroll up	scroll down	View archive memory	return home

(1) The popup message “Are you sure you want to clear the max/min?” Select  to highlight “Yes” and  to confirm.

6.2.1 Archive Memory Mode









 	View archive memory for all parameters, based on the date and time.
-------------------------------------------------------------------------------------------------------------------------------------------------------------------------	---------------------------------------------------------------------



Figure 18

				
Delete annual record	scroll left	scroll right	Recall annual record	return to archive memory mode

6.2.3 Page Selection

While viewing the annual archive memory, press the  key to view a specific page of memory.









No.	Time	Indoor Temperature (°F)	Indoor Humidity (%)	Outdoor Temperature (°F)	Outdoor Humidity (%)	Wind (mph)	Gust (mph)	Dew Point (°F)	Wind Chill (°F)	Wind Dire (°)
625	PM6:54 7/3/2012	79.2	78	79.9	74	0.0	0.0	70.9	79.9	352
626	PM6:55 7/3/2012	79.2	78	79.9	74	0.0	0.0	70.9	79.9	352
627	PM6:56 7/3/2012	79.2	78	79.9	74	0.0	0.0	70.9	79.9	352
628	PM6:57 7/3/2012	79.2	78	79.9	73	0.0	0.0	70.5	79.9	352
629	PM6:58 7/3/2012	79.2	77	80.1	73	0.0	0.0	70.7	80.1	352
630	PM6:59 7/3/2012	79.3	77	80.1	73	0.0	0.0	70.7	80.1	352
631	PM7:00 7/3/2012	79.3	77	80.1	73	0.0	0.0	70.3	80.1	352
632	PM7:01 7/3/2012	79.5	77	80.1	73	0.0	0.0	70.5	80.2	352
633	PM7:02 7/3/2012	79.5	77	80.1	73	0.0	0.0	70.5	80.2	352
634	PM7:03 7/3/2012	79.5	77	80.1	73	0.0	0.0	70.5	80.2	352
635	PM7:04 7/3/2012	79.7	76	80.4	72	0.0	0.0	70.7	80.4	352
636	PM7:05 7/3/2012	79.7	75	80.4	72	0.0	0.0	70.7	80.4	352
637	PM7:06 7/3/2012	79.7	75	80.4	71	0.0	0.0	70.2	80.4	352
638	PM7:07 7/3/2012	79.7	75	80.4	71	0.0	0.0	70.2	80.4	352
639	PM7:08 7/3/2012	79.9	75	78.8	71	0.0	0.0	68.7	78.8	352
640	PM7:09 7/3/2012	79.9	75	80.6	70	0.0	0.0	70.0	80.6	352

The range is 1 to 640

Ok Cancel

+
-
←
→
↑
↓

Figure 19

					
Increase page number	Decrease page number	Scroll digit to left	scroll digit right	Toggle OK or cancel, then press  to confirm	Toggle OK or cancel, then press  to confirm

6.2.4 Historical Graphs





Display historical graph data.

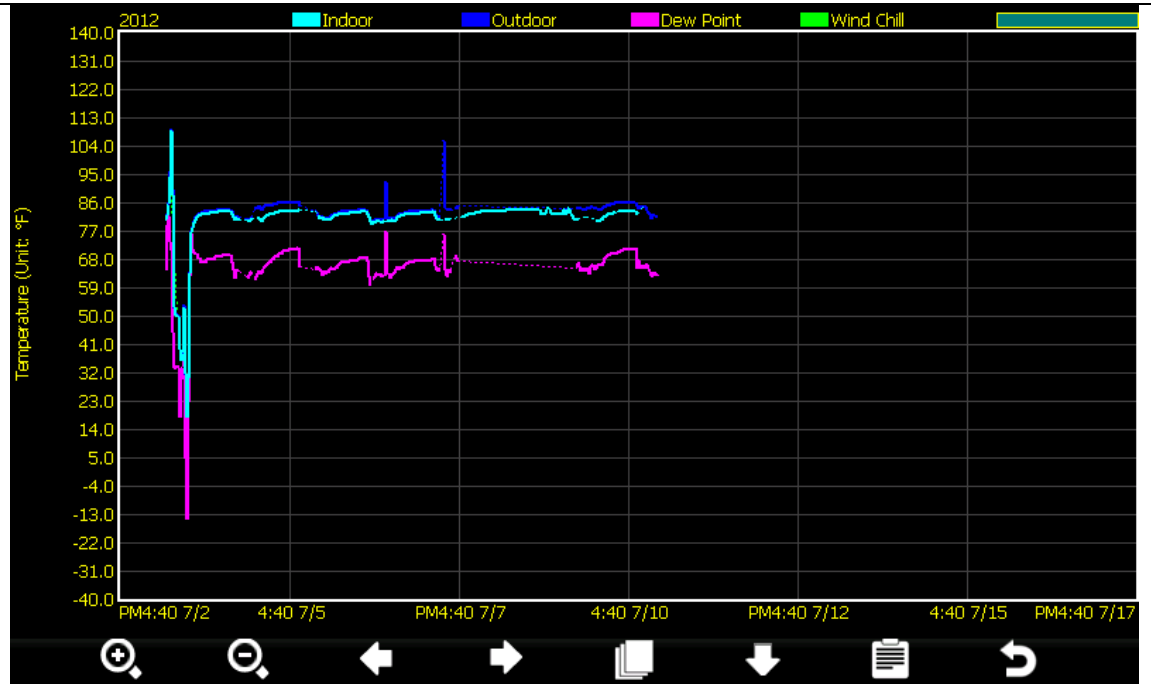









Figure 20

							
Zoom in Y-axis	Zoom out Y-axis	scroll x-axis (time) left	scroll x-axis (time) right	Recall annual archive data	scroll parameter pages	Return to Max/Min	Return home

6.3 Set Mode



Enter the Setup Mode

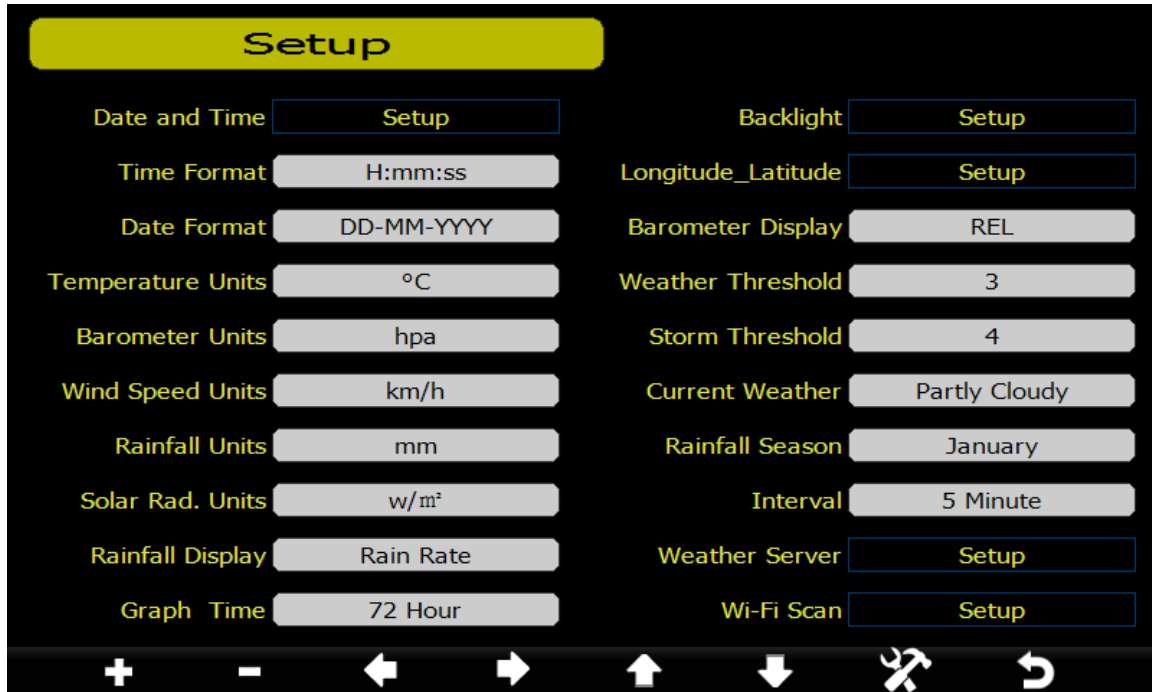





















Figure 21



							
Select units of measure or scroll value up	Select units of measure or scroll value down	Select value	Select value	Scroll field up	Scroll field down	Enter sub-setup mode	return to home



6.3.1 Set Date and Time



Set the date and time. Set automatic time synchronization

1. **Set Time.** (hour:minute:second) Press  to set the time. The hour field will turn red. Press  or  to select hour, minute or second. Press  or  to increase or decrease the value.
2. **Set Date.** (month:day:year) Press  to set the date. The month field will turn red. Press  or  to select month, day or year. Press  or  to increase or decrease the value.
3. **Set Time Zone.** Press  to set the time zone. Press  to increase the time zone and

 to decrease the time zone. With time zone highlighted, press  to set Daylight Savings Time (DST). Press  to toggle ON or OFF. Note: the DST should be always checked to automatically update the time when DST changes.

4. **Set Time Server.** The default time server is time.nist.gov. Press  to set the time server. Press  again to turn ON. Press  to toggle ON or OFF. Press  to immediately to highlight Update and  to immediately update.

 **Note:** The time server will not work until the WiFi connection has been set up.

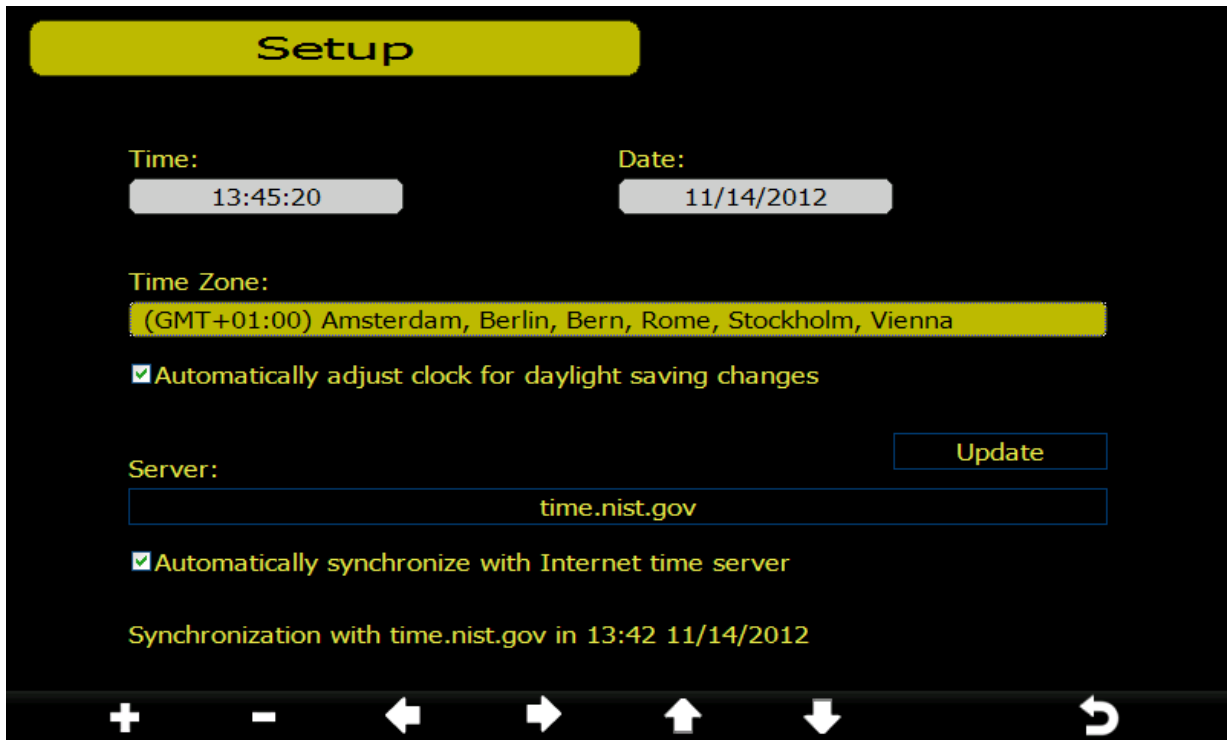









Figure 22

						
scroll value up	scroll value down	Select value	Select value	Scroll field up	Scroll field down	return to Setup

6.3.2 Set Time Format



Press  to change the time format between hour:minute:second (h:mm:ss), AM hour:minute:second (AM h:mm:ss) and hour:minute:second AM (h:mm:ss AM).

6.3.3 Temperature Units of Measure



Press  to change the temperature units of measure between °F and °C.

6.3.4 Barometer Units of Measure



Press  to change the temperature units of measure between inHg, mmHg and hpa.

6.3.5 Wind Speed Units of Measure



Press  to change the wind speed units of measure between mph, bft (beaufort scale), ft/s, m/s, km/h and knot.

6.3.6 Rainfall Units of Measure



Press  to change the rainfall units of measure between in and mm.

6.3.7 Solar Radiation Units of Measure





Press  to change the solar radiation units of measure between W/m², lux and fc.

6.3.8 Rainfall Display Increments





Press  to change the rainfall display increments between Daily Rain, Weekly Rain, Monthly Rain, Yearly Rain, and Rain Rate.

6.3.9 Graph Time



x 9

Press  to change the home screen graph display between 24, 48 and 72 hours (note: the graph will clear when the graph increment of measure is changed). The default is 72 hours.

6.3.10 Backlight Display



x 10

Automatically turn on and off the backlight or adjust the brightness based on the time of day.

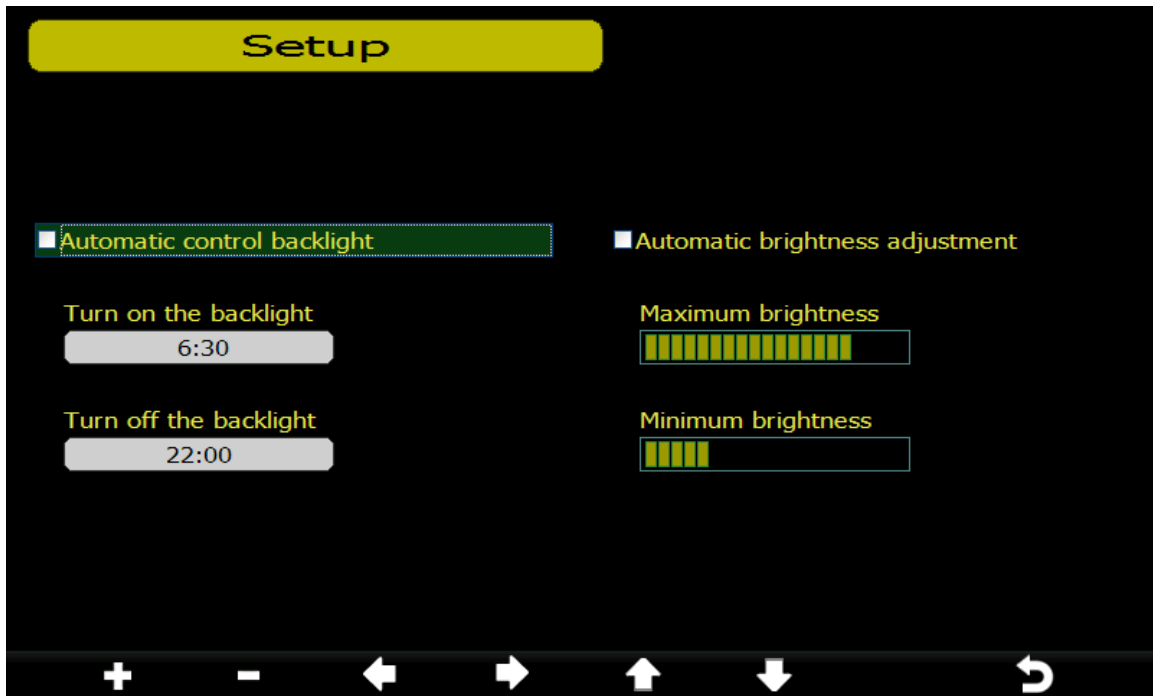













Figure 23

						
adjust up or check	adjust down or uncheck	scroll left	scroll right	scroll up	scroll down	return home

6.3.11 Longitude and Latitude





x 12





Set longitude and latitude for your location. This calculation is used for the sunrise and sunset calculation.

- Latitude.** Press  to set the Northern or Southern Hemisphere. In the USA, the hemisphere setting is **NORTH**. To change to **SOUTH**, press the  key.

Press  to change your latitude. The longitude x 10 will turn red. Press  or  to

increase or decrease the value. Press  or  to change the remaining latitude variables.

2. **Longitude.** Press  to set the Western or Eastern Hemisphere. In the USA, the hemisphere setting is **WEST**. To change to **EAST**, press the  key.

Press  to change your longitude. The longitude x 100 will turn red. Press  or  to increase or decrease the value. Press  or  to change the remaining longitude variables.

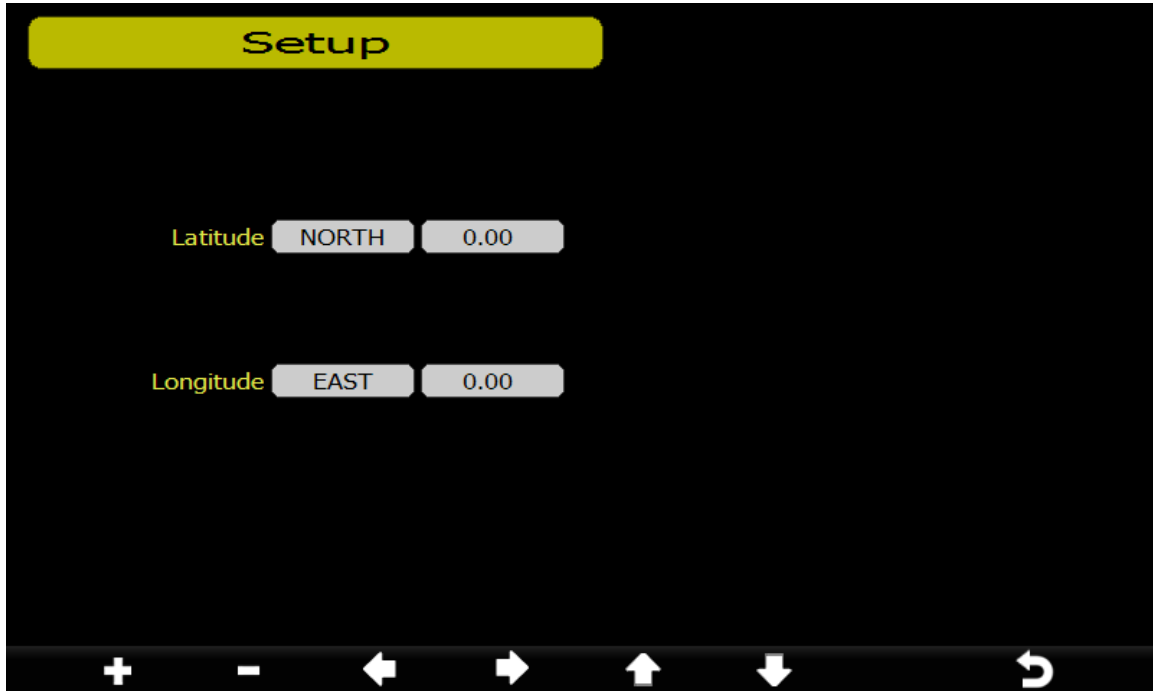

Figure 24

To determine your longitude and latitude, we recommend the following website:

www.bing.com/maps

Reference Figure 25 below:

1. Enter your address and select the search button
2. The latitude (first number) and longitude (second number) are returned. In this example:

Latitude = 33.2981181889772
 Longitude = -111.960209459066

The table below defines the hemisphere based on the positive or negative sign:

Position	Positive	Negative
Latitude	Northern	Southern
Longitude	Eastern	Western

3. In this example, the location entered into the display is as follows:

Latitude = 33.30 North
 Longitude = 111.96 West
 after rounding to two significant digits.

Record your longitude and latitude here for future reference:

Longitude:
Latitude:

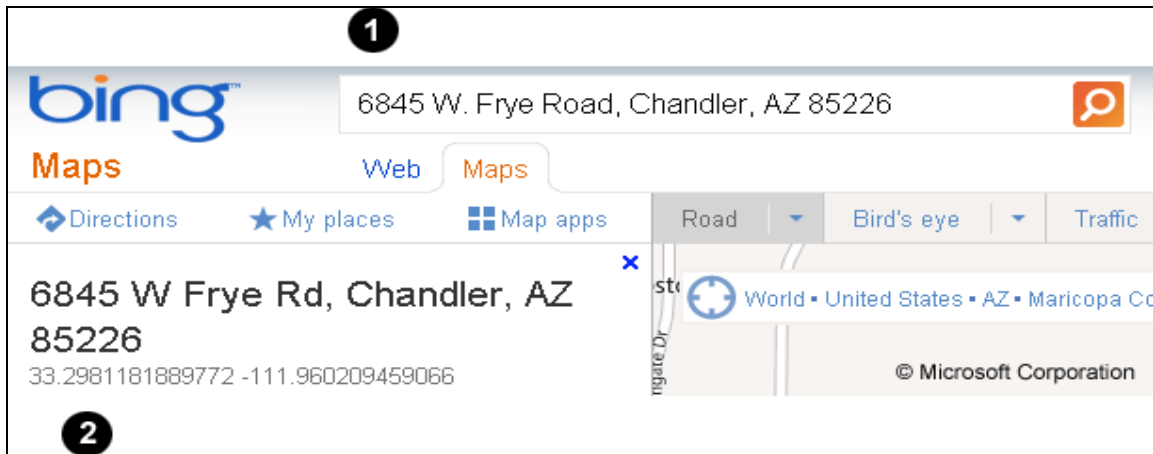





Figure 25

6.3.12 Barometer Display



x 11
 Press  to change the barometer display between REL (relative pressure) and ABS (absolute pressure).

 **Note:** The weather station console displays two different pressures: absolute (measured) and relative (corrected to sea-level).

To compare pressure conditions from one location to another, meteorologists correct pressure to sea-level conditions. Because the air pressure decreases as you rise in altitude, the sea-level corrected pressure (the pressure your location would be at if located at sea-level) is generally higher than your measured pressure.

Thus, your absolute pressure may read 28.62 inHg (969 mb) at an altitude of 1000 feet (305 m), but the relative pressure is 30.00 inHg (1016 mb).

The standard sea-level pressure is 29.92 in Hg (1013 mb). This is the average sea-level pressure around the world. Relative pressure measurements greater than 29.92 inHg (1013 mb) are considered high pressure and relative pressure measurements less than 29.92 inHg are considered low pressure.

6.3.13 Weather Threshold

Currently not used.



6.3.14 Storm Threshold

Currently not used.







6.3.15 Current Weather

Currently not used.



6.3.16 Rainfall Season

		x 13
Press  to change the beginning of the rainfall yearly season month. The default is January.		

6.3.17 Archive Interval

		x 14
Changes the archive interval for historical data and graphing. Press  to change the 100 x minute field. Press  to highlight the 10 x minute field. Press  to change the 10 x minute field. Press  to highlight the minute field. Press  to change the minute field.		

6.3.18 Weather Server

		x 15	
The console is configured to send real-time data to Wunderground.com so there is no need to adjust the Server, Server type, and upload type. Enter the Station ID and Password from Wunderground.com. Enter your Station ID and password obtained from Wunderground.com			

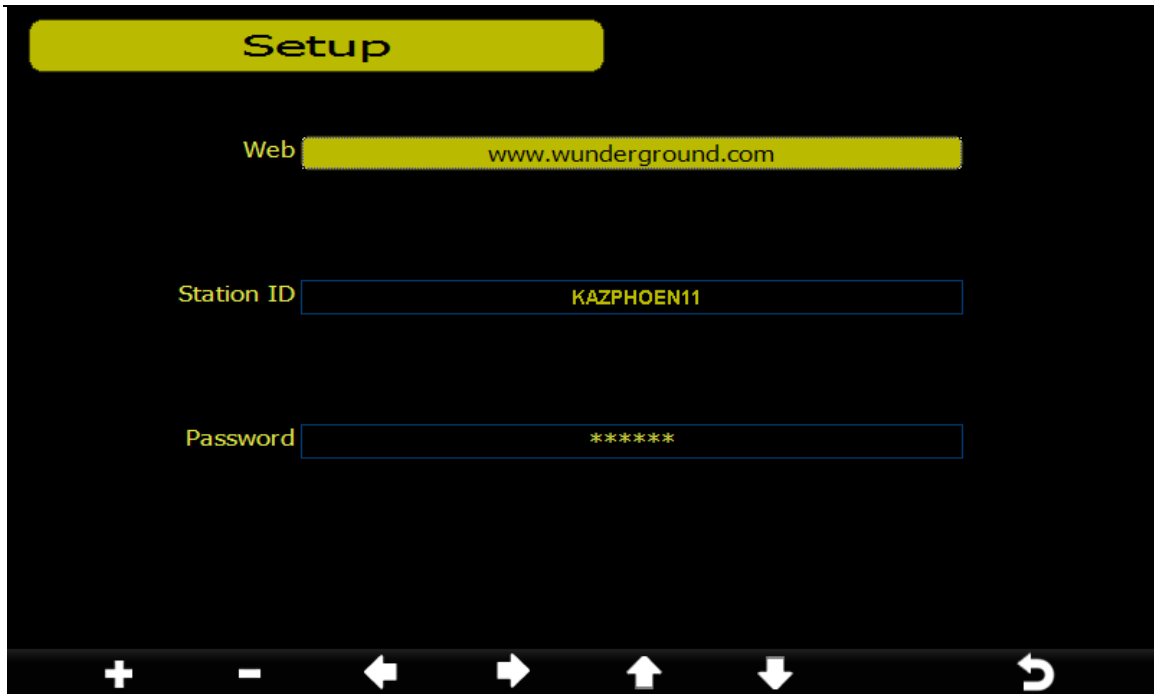























Figure 26

				
scroll value up	scroll value down	Scroll field up	Scroll field down	return to Setup

- Set Station ID.** Press  to highlight the Station ID. Enter your station ID obtained from Wunderground.com. Press  to display the keyboard. Press     to scroll to the character and press  to select the character. Press  to return to the Wunderground.com setup page.
- Set Password.** Press  to highlight the Password. Enter your password obtained from Wunderground.com. Press  to display the keyboard. Press     to scroll to the character and press  to select the character. Press  to return to the Wunderground.com setup page.

 **Note: How to create a Wunderground.com account and station ID.**

- Join the Wunderground.com Community. Visit:
<https://www.wunderground.com/members/signup.asp>
 and sign up with Wunderground.com.

Join the wunderground Community

Become a Member

wunderground Account

Join with New Account

or

Use your Facebook Account

f Join using Facebook

Already a member? [Sign in.](#)

2. **Join the Personal Weather Station (PWS) network.** Visit:

<http://www.wunderground.com/weatherstation/about.asp>

and **Get Started!** to add your weather station and you will receive a Station ID.

Get your own FRONT-DOOR FORECAST! Get Started!

JOIN OUR
PWS NETWORK!

(Personal Weather Station)

WHAT IS A PWS?

THE BENEFITS OF JOINING OUR NETWORK

A personal weather station (PWS) is an outdoor instrument that measures weather conditions.

Basic stations may include a thermometer, barometer, anemometer, hygrometer, and wind vanes. More sophisticated stations may also measure UV index, leaf wetness, soil moisture and temperature, and water temperature.

Learn More

By purchasing your own station and joining our PWS community, you can:

- Get personalized forecasts based on your own weather data
- Access archived data with charts & graphs
- Easily share your weather data

Learn More

Your PWS data will go into our proprietary forecasting model, making forecasts more local and more accurate.

Our PWS network is the world's largest, with over 25,000 active stations and growing. Be a part of our community and join today!

Get Started!

Enter the Station ID obtained and password you entered in the console's Weather Server page.

 **Note:** If Wunderground.com is not updating, make sure the Station ID and Password are correct. The Station ID is all capital letters, and the password is case sensitive. The most common issue is substituting an O for 0 in the Station ID. Example, You live in Phoenix, AZ and you are station number 11:

KAZPHOEN11, not KAZPHOEN11



K = USA station designation









AZ = Arizona



PHOEN = Phoenix

11= station 11 in Phoenix, AZ

6.3.19 WiFi Scan

 x 16
 

Press  to select your wireless network. Press  to enter the password. Press     to scroll to the character and press  to select the character. Press  to return to the WiFi Network setup page. Leave the password blank if the WiFi network is not encrypted.

 **Note:** The WiFi signal strength icon is displayed on the home page. If wireless connectivity is successful and you are reporting to Wunderground.com, the WiFi icon  will be displayed under the wind chill display on the home page.

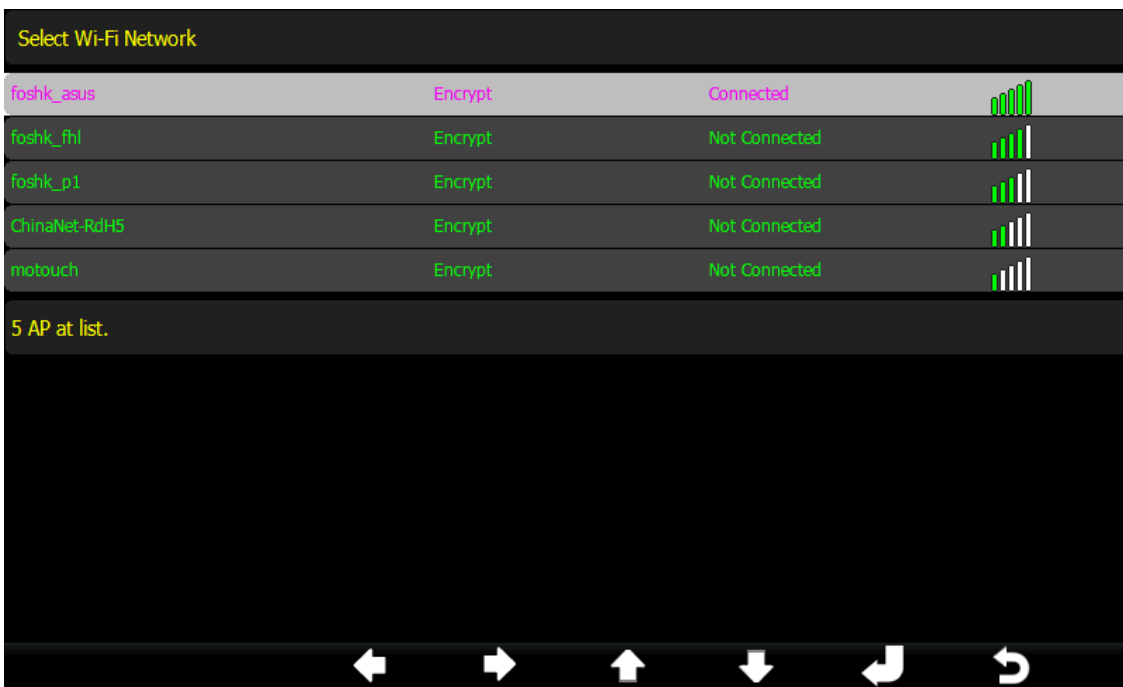









Figure 27



					
Select value	Select value	Scroll field up	Scroll field down	Select	return to Setup



6.4 Alarm Mode



Enter the Alarm Mode

The upper alarm is displayed on the right and the lower alarm is displayed on the left. If the measured value is greater than the maximum alarm setting, the alarm will sound. If the measured value is less than the minimum alarm setting, the alarm will sound.

To adjust the alarm, press  to scroll to the alarm setting you wish to change. Press  to highlight the sign (positive vs. negative) and significant digit. Press  to change the value.

To set the alarm, press  to highlight the alarm symbol  and press  to toggle the alarm ON or OFF.

When a weather alarm condition has been triggered, the alarm will sound for 120 seconds and the corresponding icon will flash until the weather condition is no longer present. Press any key to mute the alarm.

You can also set a time of day alarm using the same method.

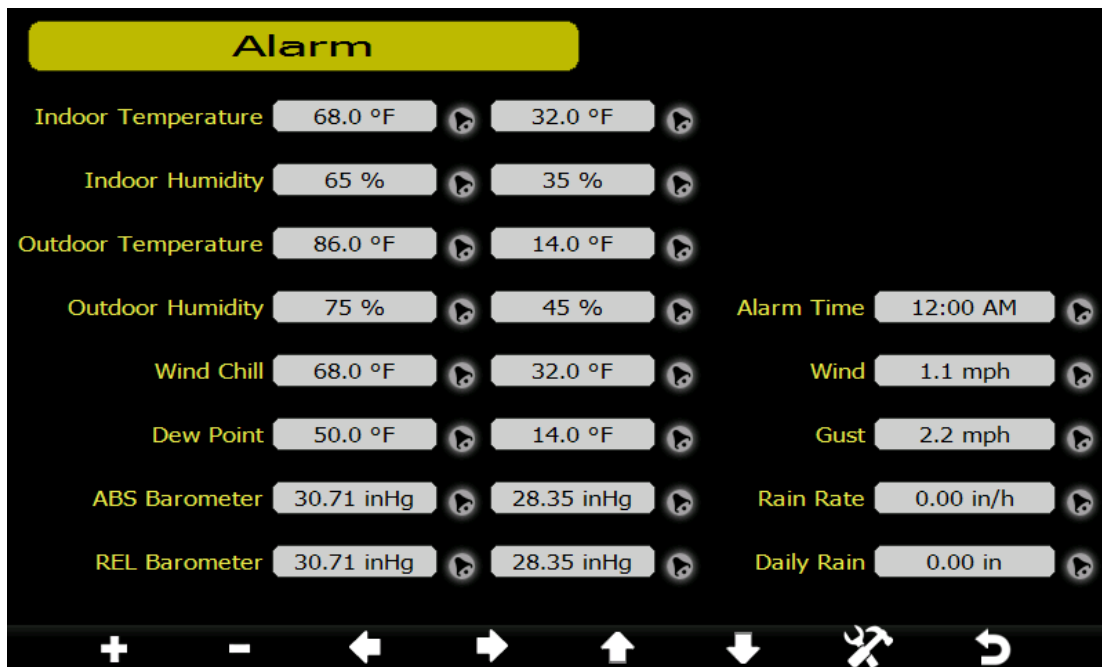









Figure 28

							
Increase alarm limit values	Decrease alarm limit values	Select value	Select value	Scroll field up	Scroll field down	Enter sub-setup mode	return to home

6.5 Calibration Mode



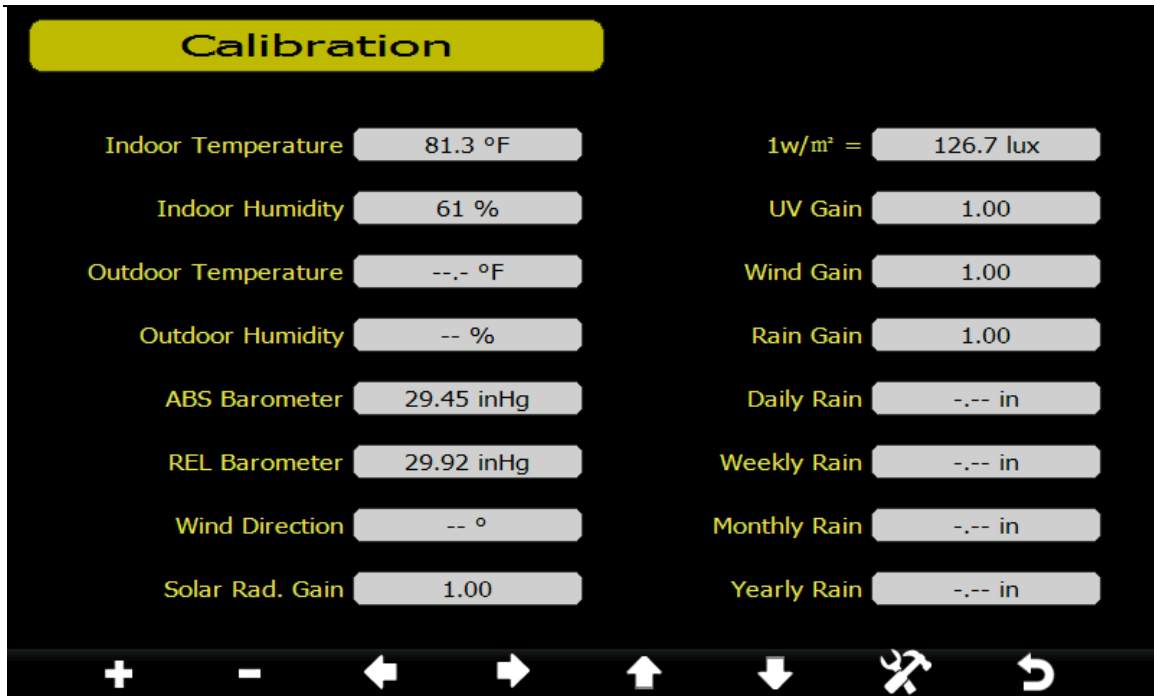













Figure 29

							
Increase calibrated value	Decrease calibrated value	Select value	Select value	Scroll field up	Scroll field down	Enter sub-setup mode	return to home

To adjust the parameter, press  to scroll to the parameter you wish to change. Press  to highlight the sign (positive vs. negative, if applicable) and significant digit. Press  or  to change the calibrated value.

Parameter	Type of Calibration	Default	Typical Calibration Source
Temperature	Offset	Current Value	Red Spirit or Mercury Thermometer (1)
Humidity	Offset	Current Value	Sling Psychrometer (2)
ABS Barometer	Offset	Current Value	Calibrated laboratory grade barometer
REL Barometer	Offset	Current Value	Local airport (3)
Wind Direction	Offset	Current Value	GPS, Compass (4)
Solar Radiation	Gain	1.00	Calibrated laboratory grade solar radiation sensor
1 w/m ²	Gain	126.7 lux	Solar radiation conversion from lux to w/m ² for wavelength correction (5)
Wind	Gain	1.00	Calibrated laboratory grade wind meter (6)
Rain	Gain	1.00	Sight glass rain gauge with an aperture of at least 4" (7)
Daily Rain	Offset	Current Value	Apply an offset if the weather station was not operating for the entire day.
Weekly Rain	Offset	Current Value	Apply an offset if the weather station was not operating for the entire week.
Monthly Rain	Offset	Current Value	Apply an offset if the weather station was not operating for the entire month.
Yearly Rain	Offset	Current Value	Apply an offset if the weather station was not operating for the entire year.

- (1) Temperature errors can occur when a sensor is placed too close to a heat source (such as a building structure, the ground or trees).

To calibrate temperature, we recommend a mercury or red spirit (fluid) thermometer. Bi-metal (dial) and digital thermometers (from other weather stations) are not a good source and have their own margin of error. Using a local weather station in your area is also a poor source due to changes in location, timing (airport weather stations are only updated once per hour) and possible calibration errors (many official weather stations are not properly installed and calibrated).

Place the sensor in a shaded, controlled environment next to the fluid thermometer, and allow the sensor to stabilize for 48 hours. Compare this temperature to the fluid thermometer and adjust the console to match the fluid thermometer.

- (2) Humidity is a difficult parameter to measure electronically and drifts over time due to contamination. In addition, location has an adverse affect on humidity readings (installation over dirt vs. lawn for example).

Official stations recalibrate or replace humidity sensors on a yearly basis. Due to manufacturing tolerances, the humidity is accurate to $\pm 5\%$. To improve this accuracy, the indoor and outdoor humidity can be calibrated using an accurate source, such as a sling

psychrometer.

- (3) The display console displays two different pressures: absolute (measured) and relative (corrected to sea-level).

To compare pressure conditions from one location to another, meteorologists correct pressure to sea-level conditions. Because the air pressure decreases as you rise in altitude, the sea-level corrected pressure (the pressure your location would be at if located at sea-level) is generally higher than your measured pressure.

Thus, your absolute pressure may read 28.62 inHg (969 mb) at an altitude of 1000 feet (305 m), but the relative pressure is 30.00 inHg (1016 mb).

The standard sea-level pressure is 29.92 in Hg (1013 mb). This is the average sea-level pressure around the world. Relative pressure measurements greater than 29.92 inHg (1013 mb) are considered high pressure and relative pressure measurements less than 29.92 inHg are considered low pressure.

To determine the relative pressure for your location, locate an official reporting station near you (the internet is the best source for real time barometer conditions, such as Weather.com or Wunderground.com), and set your weather station to match the official reporting station.

- (4) Only use this if you improperly installed the weather station sensor array, and did not point the direction reference to true north.
- (5) The default conversion factor based on the wavelength for bright sunlight is 126.7 lux / w/m². This variable can be adjusted by photovoltaic experts based on the light wavelength of interest, but for most weather station owners, is accurate for typical applications, such as calculating evapotranspiration and solar panel efficiency.
- (6) Wind speed is the most sensitive to installation constraints. The rule of thumb for properly installing a wind speed sensor is 4 x the distance of the tallest obstruction. For example, if your house is 20' tall and you mount the sensor on a 5' pole:

$$\text{Distance} = 4 \times (20 - 5)' = 60'.$$

Many installations are not perfect and installing the weather station on a roof can be difficult. Thus, you can calibrate for this error with a wind speed multiplier.

In addition to the installation challenges, wind cup bearings (moving parts) wear over time.

Without a calibrated source, wind speed can be difficult to measure. We recommend using a calibrated wind meter (available from Ambient Weather) and a constant speed, high speed fan.

- (7) The rain collector is calibrated at the factory based on the funnel diameter. The bucket tips every 0.01" of rain (referred to as resolution). The accumulated rainfall can be compared to a sight glass rain gauge with an aperture of at least 4". The following is a link to an accurate sight glass rain gauge:

<http://www.ambientweather.com/stpraga.html>

Make sure you periodically clean the rain gauge funnel.









Note: The purpose of calibration is to fine tune or correct for any sensor error associated with the devices margin of error. Errors can occur due to electronic variation (example, the temperature sensor is a resistive thermal device or RTD, the humidity sensor is a capacitance device), mechanical variation, or degradation (wearing of moving parts, contamination of sensors).

Calibration is only useful if you have a known calibrated source you can compare it against, and is optional. This section discusses practices, procedures and sources for sensor calibration to reduce manufacturing and degradation errors. Do not compare your readings obtained from sources such as the internet, radio, television or newspapers. The purpose of your weather station is to measure conditions of your surroundings, which vary significantly from location to location.





6.6 Factory Default







Figure 30









							
Select Setting	Select Setting	Scroll left	Scroll right	Scroll field up	Scroll field down	Enter sub-setup mode	return to home

1. **Re-register Transmitter Indoor.** Re-synchronizes the wireless signal from the indoor thermo-hygrometer-barometer. Press  to highlight this field.









Press  or  key to select re-register indoor transmitter. Press  or  key to popup the Message Box "Are you sure you want to register the new indoor transmitter?"

Press  or  to select Yes or No. Press the  key or  key to confirm the selection.









2. **Re-register Transmitter Outdoor.** Re-synchronizes the wireless signal from the outdoor sensor array. Press  to highlight this field.

Press  or  key to select re-register indoor transmitter. Press  or  key to popup the Message Box "Are you sure you want to register the new outdoor transmitter?" Press  or  to select Yes or No. Press the  key or  key to confirm the selection.









3. **Clear History.** Clears all of the historical data in archive memory. Press  to highlight this field.

Press  or  key to select re-register indoor transmitter. Press  or  key to popup the Message Box "Are you sure you want to clear history?" Press  or  to select Yes or No. Press the  key or  key to confirm the selection.







4. **Clear Max/Min.** Clears all of the minimum and maximum values in stored memory. Press  to highlight this field.

Press  or  key to select re-register indoor transmitter. Press  or  key to popup the Message Box "Are you sure you want to clear the max/min?" Press  or  to select Yes or No. Press the  key or  key to confirm the selection.

5. **Reset to Factory Default.** Clears all stored memory, calibrations and other variables to factory default. Press  to highlight this field.

Press  or  key to select re-register indoor transmitter. Press  or  key to popup the Message Box "Are you sure you want to reset to factory default?" Press  or  to select Yes or No. Press the  key or  key to confirm the selection.

6. **Backup data.** Backup data to micro SD / TF card (see the Accessories section of this manual for more information on micro SD / TF cards). Insert the micro SD / TF Card into the slot, as shown in Figure 14.

Press  to highlight this field. Press  to enter the backup mode. Press  or  to select the history year file. Press  to confirm the selection, and the year field will turn from green to purple. Press  to start the backup, press  key again to cancel the backup.

The data is stored in comma separated value (csv) file format, which can be opened in Microsoft Excel. The TF card can be read by a computer with an SD card adaptor.



Figure 31









							
Select Setting	Select Setting	Select year history file	Select year history file	Scroll field up	Scroll field down	Start or stop backup	return to Factory menu





Figure 32

6.6.1 Exporting Data File Format (Data Logging)

The format of the data is csv (comma separated value) and can be opened in a spreadsheet program such as Microsoft Excel for advanced data analysis, with the following headers:

Column	Parameter
1	No (data point number)
2	Time
3	Indoor Temperature (°F)
4	Indoor Humidity (%)
5	Outdoor Temperature (°F)
6	Outdoor Humidity (%)
7	Dew Point (°F)
8	Wind Chill (°F)
9	Wind (mph)
10	Gust (mph)
11	Wind Direction (°)
12	ABS Barometer (inHg)
13	REL Barometer (inHg)
14	Rain Rate (in/h)
15	Daily Rain (in)
16	Weekly Rain (in)
17	Monthly Rain (in)
18	Yearly Rain (in)
19	Solar Rad. (lux)
20	Heat Index (°F)
21	UV (uW/cm ²)
22	UV Index

- Language.** Supports English, Chinese, Danish, Dutch, French, German, Italian and Spanish.
 Press  to highlight this field. Press  to select the language and  to accept the changes.
- About.** Provides detailed information for troubleshooting purposes.

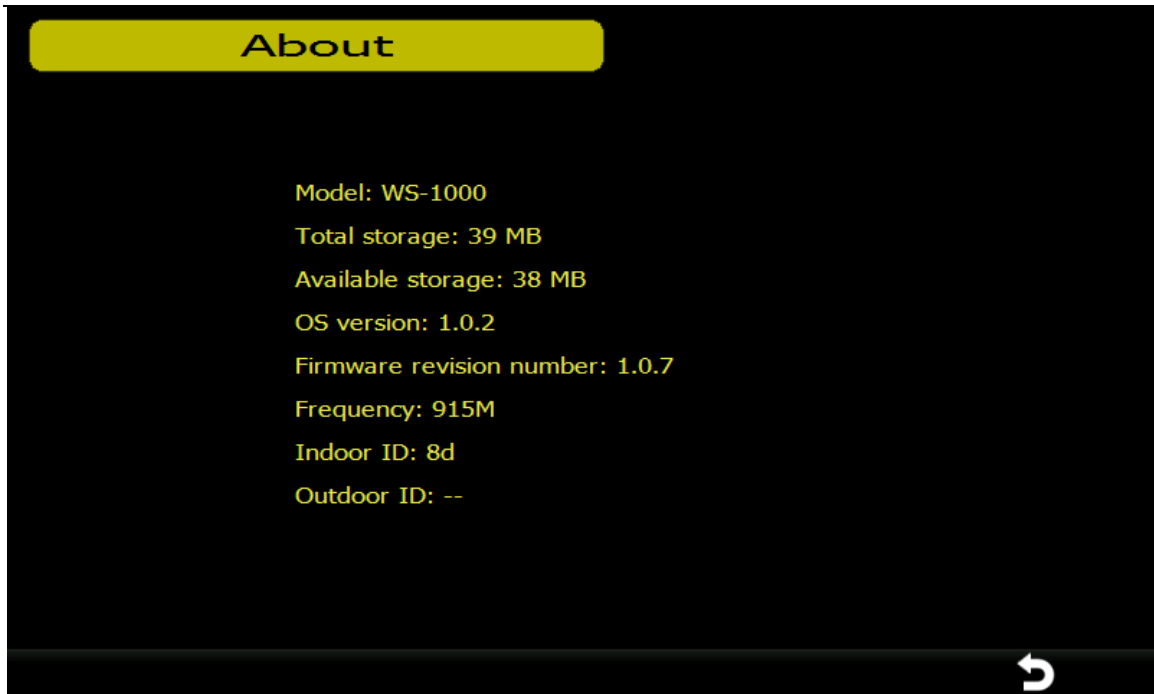

Figure 33

7. Glossary of Terms

Term	Definition
Absolute Barometric Pressure	Absolute pressure is the measured atmospheric pressure and is a function of altitude, and to a lesser extent, changes in weather conditions. Absolute pressure is not corrected to sea-level conditions. <i>Refer to Relative Barometric Pressure.</i>
Accuracy	Accuracy is defined as the ability of a measurement to match the actual value of the quantity being measured.
Barometer	A barometer is an instrument used to measure atmospheric pressure.
Calibration	Calibration is a comparison between measurements – one of known magnitude or correctness of one device (standard) and another measurement made in as similar a way as possible with a second device (instrument).
Dew Point	The dew point is the temperature at which a given parcel of humid air must be cooled, at constant barometric pressure, for water vapor to condense into water. The condensed water is called dew. The dew point is a saturation temperature. The dew point is associated with relative humidity. A high relative humidity indicates that the dew point is closer to the current air temperature. Relative humidity of 100% indicates the dew point is equal to the current temperature and the air is maximally saturated with water. When the dew point remains constant and temperature increases, relative humidity will decrease.
Heat Index	The Heat Index, sometimes referred to as the apparent temperature, is a measure of how hot it really feels when relative humidity is factored with the actual air temperature.

Term	Definition																																																																																																																																																																																																																																																						
	<p>To find the Heat Index temperature, look at the Heat Index chart below. As an example, if the air temperature is 96°F and the relative humidity is 65%, the heat index (how hot it feels) is 121°F.</p> <p>IMPORTANT: Since heat index values were devised for shady, light wind conditions, exposure to full sunshine can increase heat index values by up to 15°F. Also, strong winds, particularly with very hot, dry air, can be extremely hazardous.</p> <p>The Heat Index Chart shaded zone above 105°F shows a level that may cause increasingly severe heat disorders with continued exposure or physical activity.</p> <p>Heat Index is not calculated below 80°F.</p> <div data-bbox="446 661 1372 1270" style="text-align: center;"> <p>Relative Humidity (%)</p> <table border="1" style="display: inline-table; margin-right: 20px;"> <tr><th>°F</th><th>40</th><th>45</th><th>50</th><th>55</th><th>60</th><th>65</th><th>70</th><th>75</th><th>80</th><th>85</th><th>90</th><th>95</th><th>100</th></tr> <tr><th>110</th><td>136</td><td></td><td></td><td></td><td></td><td></td><td></td><td></td><td></td><td></td><td></td><td></td><td></td></tr> <tr><th>108</th><td>130</td><td>137</td><td></td><td></td><td></td><td></td><td></td><td></td><td></td><td></td><td></td><td></td><td></td></tr> <tr><th>106</th><td>124</td><td>130</td><td>137</td><td></td><td></td><td></td><td></td><td></td><td></td><td></td><td></td><td></td><td></td></tr> <tr><th>104</th><td>119</td><td>124</td><td>131</td><td>137</td><td></td><td></td><td></td><td></td><td></td><td></td><td></td><td></td><td></td></tr> <tr><th>102</th><td>114</td><td>119</td><td>124</td><td>130</td><td>137</td><td></td><td></td><td></td><td></td><td></td><td></td><td></td><td></td></tr> <tr><th>100</th><td>109</td><td>114</td><td>118</td><td>124</td><td>129</td><td>136</td><td></td><td></td><td></td><td></td><td></td><td></td><td></td></tr> <tr><th>98</th><td>105</td><td>109</td><td>113</td><td>117</td><td>123</td><td>128</td><td>134</td><td></td><td></td><td></td><td></td><td></td><td></td></tr> <tr><th>96</th><td>101</td><td>104</td><td>108</td><td>112</td><td>116</td><td>121</td><td>126</td><td>132</td><td></td><td></td><td></td><td></td><td></td></tr> <tr><th>94</th><td>97</td><td>100</td><td>103</td><td>106</td><td>110</td><td>114</td><td>119</td><td>124</td><td>129</td><td>135</td><td></td><td></td><td></td></tr> <tr><th>92</th><td>94</td><td>96</td><td>99</td><td>101</td><td>105</td><td>108</td><td>112</td><td>116</td><td>121</td><td>126</td><td>131</td><td></td><td></td></tr> <tr><th>90</th><td>91</td><td>93</td><td>95</td><td>97</td><td>100</td><td>103</td><td>106</td><td>109</td><td>113</td><td>117</td><td>122</td><td>127</td><td>132</td></tr> <tr><th>88</th><td>88</td><td>89</td><td>91</td><td>93</td><td>95</td><td>98</td><td>100</td><td>103</td><td>106</td><td>110</td><td>113</td><td>117</td><td>121</td></tr> <tr><th>86</th><td>85</td><td>87</td><td>88</td><td>89</td><td>91</td><td>93</td><td>95</td><td>97</td><td>100</td><td>102</td><td>105</td><td>108</td><td>112</td></tr> <tr><th>84</th><td>83</td><td>84</td><td>85</td><td>86</td><td>88</td><td>89</td><td>90</td><td>92</td><td>94</td><td>96</td><td>98</td><td>100</td><td>103</td></tr> <tr><th>82</th><td>81</td><td>82</td><td>83</td><td>84</td><td>84</td><td>85</td><td>86</td><td>88</td><td>89</td><td>90</td><td>91</td><td>93</td><td>95</td></tr> <tr><th>80</th><td>80</td><td>80</td><td>81</td><td>81</td><td>82</td><td>82</td><td>83</td><td>84</td><td>84</td><td>85</td><td>86</td><td>86</td><td>87</td></tr> </table> <div style="display: inline-block; vertical-align: middle; text-align: center;"> <p>Heat Index (Apparent Temperature)</p> </div> <div style="display: inline-block; vertical-align: middle; margin-left: 20px;"> <p>With Prolonged Exposure and/or Physical Activity</p> <table border="1" style="width: 100%;"> <tr><th style="background-color: #d62728;">Extreme Danger</th></tr> <tr><td style="text-align: center;">Heat stroke or sunstroke highly likely</td></tr> <tr><th style="background-color: #ffc107;">Danger</th></tr> <tr><td style="text-align: center;">Sunstroke, muscle cramps, and/or heat exhaustion likely</td></tr> <tr><th style="background-color: #ffc107;">Extreme Caution</th></tr> <tr><td style="text-align: center;">Sunstroke, muscle cramps, and/or heat exhaustion possible</td></tr> <tr><th style="background-color: #ffc107;">Caution</th></tr> <tr><td style="text-align: center;">Fatigue possible</td></tr> </table> </div> </div>	°F	40	45	50	55	60	65	70	75	80	85	90	95	100	110	136													108	130	137												106	124	130	137											104	119	124	131	137										102	114	119	124	130	137									100	109	114	118	124	129	136								98	105	109	113	117	123	128	134							96	101	104	108	112	116	121	126	132						94	97	100	103	106	110	114	119	124	129	135				92	94	96	99	101	105	108	112	116	121	126	131			90	91	93	95	97	100	103	106	109	113	117	122	127	132	88	88	89	91	93	95	98	100	103	106	110	113	117	121	86	85	87	88	89	91	93	95	97	100	102	105	108	112	84	83	84	85	86	88	89	90	92	94	96	98	100	103	82	81	82	83	84	84	85	86	88	89	90	91	93	95	80	80	80	81	81	82	82	83	84	84	85	86	86	87	Extreme Danger	Heat stroke or sunstroke highly likely	Danger	Sunstroke, muscle cramps, and/or heat exhaustion likely	Extreme Caution	Sunstroke, muscle cramps, and/or heat exhaustion possible	Caution	Fatigue possible
°F	40	45	50	55	60	65	70	75	80	85	90	95	100																																																																																																																																																																																																																																										
110	136																																																																																																																																																																																																																																																						
108	130	137																																																																																																																																																																																																																																																					
106	124	130	137																																																																																																																																																																																																																																																				
104	119	124	131	137																																																																																																																																																																																																																																																			
102	114	119	124	130	137																																																																																																																																																																																																																																																		
100	109	114	118	124	129	136																																																																																																																																																																																																																																																	
98	105	109	113	117	123	128	134																																																																																																																																																																																																																																																
96	101	104	108	112	116	121	126	132																																																																																																																																																																																																																																															
94	97	100	103	106	110	114	119	124	129	135																																																																																																																																																																																																																																													
92	94	96	99	101	105	108	112	116	121	126	131																																																																																																																																																																																																																																												
90	91	93	95	97	100	103	106	109	113	117	122	127	132																																																																																																																																																																																																																																										
88	88	89	91	93	95	98	100	103	106	110	113	117	121																																																																																																																																																																																																																																										
86	85	87	88	89	91	93	95	97	100	102	105	108	112																																																																																																																																																																																																																																										
84	83	84	85	86	88	89	90	92	94	96	98	100	103																																																																																																																																																																																																																																										
82	81	82	83	84	84	85	86	88	89	90	91	93	95																																																																																																																																																																																																																																										
80	80	80	81	81	82	82	83	84	84	85	86	86	87																																																																																																																																																																																																																																										
Extreme Danger																																																																																																																																																																																																																																																							
Heat stroke or sunstroke highly likely																																																																																																																																																																																																																																																							
Danger																																																																																																																																																																																																																																																							
Sunstroke, muscle cramps, and/or heat exhaustion likely																																																																																																																																																																																																																																																							
Extreme Caution																																																																																																																																																																																																																																																							
Sunstroke, muscle cramps, and/or heat exhaustion possible																																																																																																																																																																																																																																																							
Caution																																																																																																																																																																																																																																																							
Fatigue possible																																																																																																																																																																																																																																																							
HectoPascals (hPa)	Pressure units in SI (international system) units of measurement. Same as millibars (1 hPa = 1 mbar)																																																																																																																																																																																																																																																						
Hygrometer	A hygrometer is a device that measures relative humidity. Relative humidity is a term used to describe the amount or percentage of water vapor that exists in air.																																																																																																																																																																																																																																																						
Inches of Mercury (inHg)	Pressure in Imperial units of measure. 1 inch of mercury = 33.86 millibars																																																																																																																																																																																																																																																						
Rain Gauge	<p>A rain gauge is a device that measures liquid precipitation (rain), as opposed to solid precipitation (snow gauge) over a set period of time.</p> <p>All digital rain gauges are self emptying or self dumping (also referred to as tipping rain gauge). The precision of the rain gauge is based on the volume of rain per emptying cycle.</p>																																																																																																																																																																																																																																																						
Range	Range is defined as the amount or extent a value can be measured.																																																																																																																																																																																																																																																						
Relative Barometric Pressure	Measured barometric pressure relative to your location or ambient conditions.																																																																																																																																																																																																																																																						
Resolution	Resolution is defined as the number of significant digits (decimal places) to which a value is being reliably measured.																																																																																																																																																																																																																																																						

Term	Definition
Solar Radiation	<p>A solar radiation sensor measures solar energy from the sun.</p> <p>Solar radiation is radiant energy emitted by the sun from a nuclear fusion reaction that creates electromagnetic energy. The spectrum of solar radiation is close to that of a black body with a temperature of about 5800 K. About half of the radiation is in the visible short-wave part of the electromagnetic spectrum. The other half is mostly in the near-infrared part, with some in the ultraviolet part of the spectrum.</p>
Thermometer	A thermometer is a device that measures temperature. Most digital thermometers are resistive thermal devices (RTD). RTDs predict change in temperature as a function of electrical resistance.
Wind Vane	A wind vane is a device that measures the direction of the wind. The wind vane is usually combined with the anemometer. Wind direction is the direction from which the wind is blowing.

8. Specifications

8.1 Wireless Specifications

- Line of sight wireless transmission (in open air): 330 feet, 100 feet under most conditions
- Update Rate: Outdoor Sensor: 16 seconds, Indoor Sensor: 64 seconds
- Frequency: 915 MHz

8.2 Measurement Specifications

The following table provides the specifications for the measured parameters.

Measurement	Range	Accuracy	Resolution
Indoor Temperature	32 to 140 °F	± 2 °F	0.1 °F
Outdoor Temperature	-40 to 149 °F sensor -23 to 140 °F rechargeable battery range (alkaline)	± 2 °F	0.1 °F
Indoor Humidity	1 to 99%	± 5%	1 %
Outdoor Humidity	1 to 99%	± 5%	1 %
Barometric Pressure	8.85 to 32.50 inHg	± 0.08 inHg (within range of 27.13 to 32.50 inHg)	0.01 inHg
Light	0 to 400,000 Lux	± 15%	1 Lux
Rain	0 to 394 in.	± 10%	0.01 in
Wind Direction	0 - 360 °	1°	1°
Wind Speed	0 to 100 mph (operational)	± 2.2 mph or 10% (whichever is greater)	0.1 mph

8.3 Power Consumption

- Base station : 5V DC Adaptor (included), Power Consumption: 7.5 Watts
- Indoor Thermo-hygrometer-barometer sensor : 2xAAA batteries (not included)
- Outdoor sensor array: 3xAA alkaline rechargeable batteries (included)

9. Maintenance

1. Clean the rain gauge once every 3 months as follows. Reference Figure 34.

Step 1: Make a note of the current rain totals by referencing the calibration screen (reference Section 6.5). You will need to re-enter these values after the calibration procedure is complete.

Step 2: Pour water into the rain collector to moisturize the dirt inside rain bucket.

Step 3: Use an approximately 3 inch (80 mm) long cotton swab, and push the cotton tip through the rain collector hole until it reaches the self emptying mechanism, and press until the mechanism no longer rotates.

Step 4: Rotate the cotton swab back and forth, removing dirt from the tipping mechanism and rain collector hole.

Step 5: Remove the cotton swab and flush with water to remove any remaining dirt.

Step 6: Re-enter the rain totals recorded in Step 1.

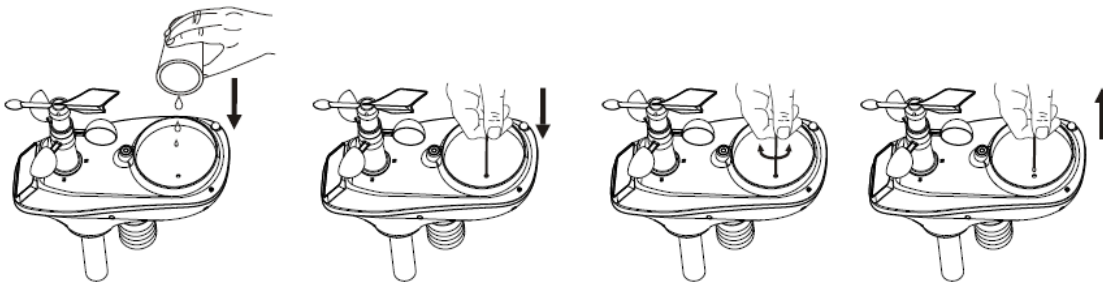

Figure 34

2. Clean the solar radiation sensor every 3 months with water and towel.
3. Replace rechargeable batteries every 2 to 3 years.

9.1 Advanced Rain Gauge Cleaning

If the rain gauge stops updating, it is possible for spiders and other insects to nest inside the sensor array housing and interfere with the rain gauge mechanism.

1. Remove the six screws on the bottom of the sensor array, as shown in Figure 35.
2. **CAREFULLY** separate the top housing from the bottom housing. They cannot be completely separated due to wires. **DO NOT STRESS THE WIRES**. Open the sensor housing slightly, like a clam shell.
3. Clean any debris and spider webs, as shown in Figure 36.

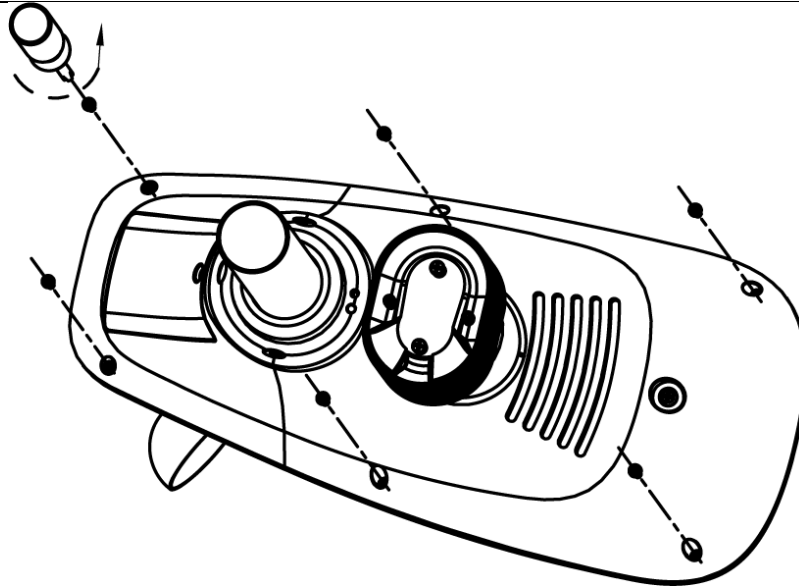
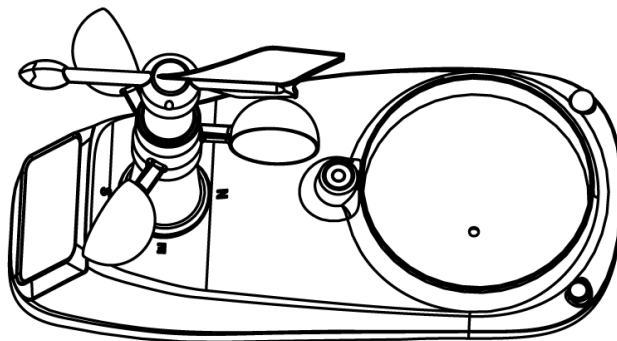

Figure 35



Do not stress wires

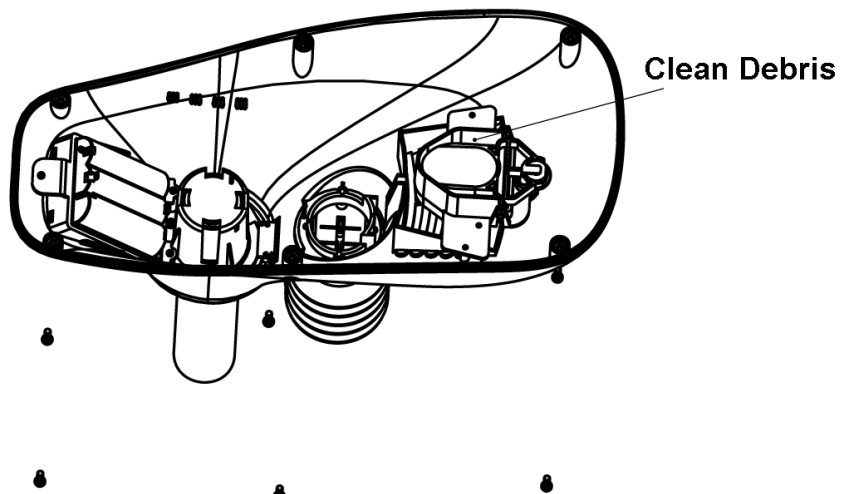



Figure 36

10. Troubleshooting Guide

If your question is not answered here, you can contact us as follows:

1. Email Support: support@ambientweather.com
2. Live Chat Support: www.ambientweather.com/chat.html (M-F 8am to 4pm Arizona Time)
3. Technical Support: 480-346-3398 (M-F 8am to 4pm Arizona Time)

Problem	Solution
<p>Wireless remote (thermo-hygrometer) not reporting in to console.</p> <p>There are dashes on the display console.</p>	<p>The maximum line of sight communication range is about 300'. Move the sensor assembly closer to the display console.</p> <p>Resynchronize the remote sensor(s). Reference Section 6.6.</p> <p>Install a fresh set of batteries in the remote sensor(s).</p> <p>Make sure the remote sensors are not transmitting through solid metal (acts as an RF shield), or earth barrier (down a hill). Radio Frequency (RF) Sensors cannot transmit through metal barriers (example, aluminum siding) or multiple, thick walls.</p> <p>Move the display console around electrical noise generating devices, such as computers, TVs and other wireless transmitters or receivers.</p>
<p>Outdoor sensor array does not communicate to the display console.</p>	<p>The sensor array may have initiated properly and the data is registered by the console as invalid, and the console must be reset. The reset button is next to the LED, near the mounting point on the sensor array, as shown in Figure 11.</p> <p>With an open ended paperclip, press the reset button for 3 seconds to completely discharge the voltage.</p> <p>Take out the batteries and wait one minute, while covering the solar panel to drain the voltage.</p> <p>Put batteries back in and resync with console by powering down and up the console with the sensor array about 10 feet away.</p> <p>Bring the sensor array inside the house (you can disconnect it from the rest of the sensors). The LED next to the battery compartment will flash every 16 seconds. If the LED is not flashing every 16 seconds...</p> <p>Replace the batteries in the outside sensor array. Non-rechargeable batteries are OK for testing purposes. If the batteries were recently replaced, check the polarity. If the sensor is flashing every 48 seconds, proceed to the next step.</p> <p>There may be a temporary loss of communication due to reception loss related to interference or other location factors,</p> <p>or the batteries may have been changed in the sensor array and the console has not been reset. The solution may be as simple as powering down and up the console.</p>

Problem	Solution
	<p>Replace the batteries in the outside sensor array. Non-rechargeable batteries are OK for testing purposes.</p> <p>With the sensor array and console 10 feet away from each other, remove AC power from the display console and wait 10 seconds. Re-connect power.</p>
Temperature sensor reads too high in the day time.	<p>Make certain that the sensor array is not too close to heat generating sources or structures, such as buildings, pavement, walls or air conditioning units.</p> <p>Use the calibration feature to offset installation issues related to radiant heat sources. Reference 6.5.</p>
Absolute pressure does not agree with official reporting station	<p>You may be viewing the relative pressure, not the absolute pressure.</p> <p>Select the absolute pressure. Make sure you properly calibrate the sensor to an official local weather station. Reference Section 6.5 for details.</p>
Rain gauge reports rain when it is not raining	<p>An unstable mounting solution (sway in the mounting pole) may result in the tipping bucket incorrectly incrementing rainfall. Make sure you have a stable, level mounting solution.</p>
Data not reporting to Wunderground.com	<ol style="list-style-type: none"> 1. Confirm your password is correct. It is the password you registered on Wunderground.com. Your Wunderground.com password cannot begin with a non-alphanumeric character (a limitation of Wunderground.com, not the station). Example, \$oewkrf is not a valid password, but oewkrf\$ is valid. 2. Confirm your station ID is correct. The station ID is all caps, and the most common issue is substituting an O for a 0 (or visa versa). Example, KAZPHOEN11, not KAZPH0EN11 3. Make sure the date and time is correct on the console. If incorrect, you may be reporting old data, not real time data. 4. Make sure your time zone is set properly. If incorrect, you may be reporting old data, not real time data. 5. Check your router firewall settings. The console sends data via Port 80.
No WiFi connection	<ol style="list-style-type: none"> 1. Check for WiFi signal strength symbol on the display . If wireless connectivity is successful and reporting to Wunderground.com, the WiFi icon  will be displayed under the wind chill display on the home page. 2. Make sure your modem WiFi settings are correct (network name, password and security settings).
Heat Index is not showing on the display	<p>The heat index is not displayed for values less than 80 °F.</p>
Sunrise and sunset is incorrect	<p>Make certain your time zone, longitude and latitude are set properly.</p>

11. Accessories

The following software and hardware accessories are available for this weather station at www.AmbientWeather.com.

Accessory	Description
microSDHC Class 4 Flash Memory Card SDC4/8GB	MicroSDHC for data backup and advanced data analysis.
Ambient Weather Mounting Solutions	Ambient Weather provides the most comprehensive mounting solutions for weather stations, including tripods, pole extensions, pole mounting kits, guy wires, ground stakes and more.
Ambient Weather WS-1000-BATT 3 x AA Rechargeable Batteries for WS-1000-WiFi Outdoor Sensor Array	Ambient Weather WS-1000-BATT 3 x AA Rechargeable Batteries for WS-1000-WiFi Outdoor Sensor Array (replacement).

12. Liability Disclaimer

Please help in the preservation of the environment and return used batteries to an authorized depot. The electrical and electronic wastes contain hazardous substances. Disposal of electronic waste in wild country and/or in unauthorized grounds strongly damages the environment.

Reading the “User manual” is highly recommended. The manufacturer and supplier cannot accept any responsibility for any incorrect readings and any consequences that occur should an inaccurate reading take place.

This product is designed for use in the home only as indication of weather conditions. This product is not to be used for medical purposes or for public safety information.

The specifications of this product may change without prior notice.

This product is not a toy. Keep out of the reach of children.

No part of this manual may be reproduced without written authorization of the manufacturer.

Ambient, LLC WILL NOT ASSUME LIABILITY FOR INCIDENTAL, CONSEQUENTIAL, PUNITIVE, OR OTHER SIMILAR DAMAGES ASSOCIATED WITH THE OPERATION OR MALFUNCTION OF THIS PRODUCT.

13. FCC Statement

Statement according to FCC part 15.19:

This device complies with part 15 of the FCC rules. Operation is subject to the following two conditions:

1. This device may not cause harmful interference.
2. This device must accept any interference received, including interference that may cause undesired operation.

Statement according to FCC part 15.21:

Modifications not expressly approved by this company could void the user's authority to operate the equipment.

Statement according to FCC part 15.105:

NOTE: This equipment has been tested and found to comply with the limits for a Class B digital device, pursuant to Part 15 of the FCC Rules. These limits are designed to provide reasonable protection against harmful interference in a residential installation. This equipment generates, uses and can radiate radio frequency energy and, if not installed and used in accordance with the instructions, may cause harmful interference to radio communications.

However, there is no guarantee that interference will not occur in a particular installation. If this equipment does cause harmful interference to radio or television reception, which can be determined by turning the equipment off and on, the user is encouraged to try to correct the interference by one or more of the following measures:

- Reorient or relocate the receiving antenna.
- Increase the separation between the equipment and receiver.
- Connect the equipment into an outlet on a circuit different from that to which the receiver is connected.
- Consult the dealer or an experienced radio/TV technician for help.

14. Warranty Information

Ambient, LLC provides a 1-year limited warranty on this product against manufacturing defects in materials and workmanship.

This limited warranty begins on the original date of purchase, is valid only on products purchased and only to the original purchaser of this product. To receive warranty service, the purchaser must contact Ambient, LLC for problem determination and service procedures.

Warranty service can only be performed by a Ambient, LLC. The original dated bill of sale must be presented upon request as proof of purchase to Ambient, LLC.

Your Ambient, LLC warranty covers all defects in material and workmanship with the following specified exceptions: (1) damage caused by accident, unreasonable use or neglect (lack of reasonable and necessary maintenance); (3) damage resulting from failure to follow instructions contained in your owner's manual; (4) damage resulting from the performance of repairs or alterations by someone other than an authorized Ambient, LLC authorized service center; (5) units used for other than personal use (6) applications and uses that this product was not intended (7) the products inability to receive a signal due to any source of interference or metal obstructions and (8) extreme acts of nature, such as lightning strikes or floods.

This warranty covers only actual defects within the product itself, and does not cover the cost of installation or removal from a fixed installation, normal set-up or adjustments, claims based on misrepresentation by the seller or performance variations resulting from installation-related circumstances.

