

# Ambient Weather WS-1070 Wireless Home Weather Station

## User Manual



### Table of Contents

1. Introduction .....	2
2. Warnings and Cautions .....	2
3. Getting Started.....	2
3.1 Parts List .....	3
3.2 Recommend Tools .....	3
3.3 Sensor Assembly Set Up.....	4
3.4 Display Console.....	7
3.4.1 Display Console Layout .....	7
3.4.1 Initial Display Console Set Up .....	9
3.4.2 Radio Controlled Clock (RCC) .....	9
3.4.3 Sensor Operation Verification.....	9
4. Weather Station Installation.....	10
4.1 Pre Installation Checkout.....	10
4.2 Site Survey.....	10
4.3 Final Installation of Sensor Array.....	10
5. Console Operation .....	10
5.1 Set Mode.....	10
5.1.1 Set Time.....	11
5.1.2 Set Date .....	12
5.1.3 Set Indoor Temperature and Outdoor Temperature Units.....	12
5.1.4 Set Barometric Pressure.....	12
5.1.5 Set Wind Units.....	13
5.1.5 Set Rain Units.....	13
5.2 Quick Set Mode .....	13
5.2.1 Outdoor Temperature, Wind chill and Dew Point Display .....	13
5.2.2 Relative and Absolute Pressure Display .....	13
5.2.3 Average Wind Speed and Wind Gust.....	13
5.2.4 Rain Display and Reset.....	13
5.3 History Mode.....	13
5.4 Alarm Mode.....	14
5.4.1 High Alarm Mode.....	14
5.4.2 Low Alarm Mode.....	16
5.4.3 Cancelling an Alarm .....	16
5.4.4 Outdoor Temperature/ Wind Chill / Dew Point Alarm .....	16
5.5 Min/Max Mode.....	17
5.5.1 Maximum Mode .....	17

5.5.2	Minimum Mode .....	18
5.6	Other Console Features.....	19
5.6.1	Weather Forecasting .....	19
5.6.2	Weather Icons .....	19
5.6.3	Weather tendency indicator .....	19
5.6.4	Storm threshold indicator .....	20
5.6.5	Pressure threshold setting .....	20
5.6.6	Pressure Graph.....	20
6.	Glossary of Terms.....	20
7.	Specifications .....	21
7.1	Wireless Specifications .....	21
7.2	Measurement Specifications .....	21
7.3	Power Consumption.....	21
7.4	Cable Lengths .....	21
8.	Troubleshooting Guide .....	22
9.	Accessories.....	23
10.	Liability Disclaimer .....	24
11.	FCC Statement.....	24
12.	Warranty Information.....	25

## 1. Introduction

Thank you for your purchase of the Ambient Weather WS-1070 wireless weather station. The following user guide provides step by step instructions for installation, operation and troubleshooting. To download the latest manual and additional troubleshooting tips, please visit:

<http://ambientweather.wikispaces.com/ws1050>

## 2. Warnings and Cautions

 **Warning:** Any metal object may attract a lightning strike, including your weather station mounting pole.

Never install the weather station in a storm.

 **Warning:** Installing your weather station in a high location may result in injury or death. Perform as much of the initial check out and operation on the ground and inside a building or home. Only install the weather station on a clear, dry day.

## 3. Getting Started

The WS-1070 weather station consists of a display console (receiver), a thermo-hygrometer transmitter unit, a wind speed sensor, a rain gauge, and mounting hardware.

### 3.1 Parts List

QTY	Item
1	Display Console Frame Dimensions (LxWxH): 6.5" x 6" x 1.25" LCD Dimensions (LxW): 5" x 2.75"
1	Thermo-hygrometer transmitter (measures temperature and humidity)
1	Thermo-hygrometer transmitter mounting bracket
1	Thermo-hygrometer transmitter radiation shield
1	Wind speed sensor
1	Rain gauge
1	Rain gauge mounting bracket
1	1" nut and bolt (long)
1	13/16" nut and bolt (short)
1	1/2" set screw (long)
1	3/8" set screw (short) (Optional)
1	Upper pole (L: 12")
1	Lower pole (L: 12")
4	Zip ties
2	Hose clamps (2 3/4" diameter)

### 3.2 Recommend Tools

- Precision screwdriver (for small Phillips screws)
- Pliers
- Phillips screwdriver
- Flat blade screwdriver
- Tack (small) hammer or rubber mallet

### 3.3 Sensor Assembly Set Up

Connect the wind cup assembly to the top end of the top mounting pole. Align the holes, and fasten with long bolt and nut. Tighten with precision screwdriver while securing the nut with pliers, as shown in

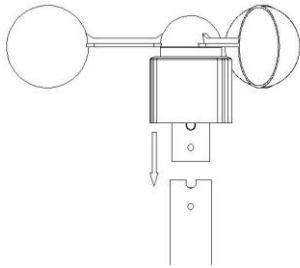

Front

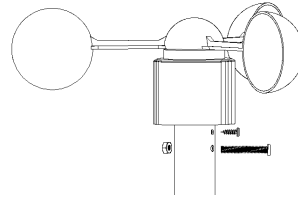

Back

1. Figure 1 (front and back view). Attach the small set screw (optional). The set screw will not set flush with the pole. Do not over tighten.

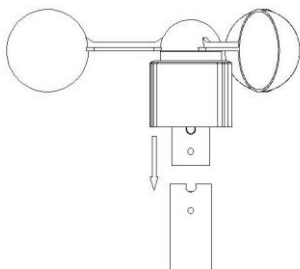

Front

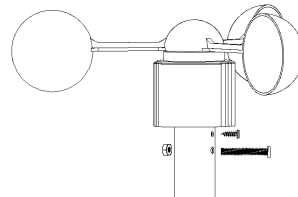

Back

**Figure 1**

2. Connect the rain gauge with long set screw. Tighten with precision screwdriver, as shown in Figure 2.

 **Note:** There may be a slight “play” in the rain gauge and the screw may not be flush. Do not force the screw.

 **Note:** There are two mounting holes on the side of the rain gauge in the event you wish to mount the rain gauge in a different location than the mounting arm.

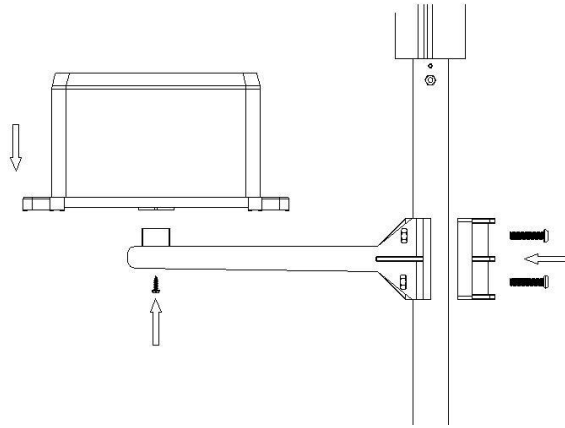

**Figure 2**

3. Connect the thermo-hygrometer with short bolt and nut. Tighten with precision screwdriver, as shown in Figure 3. Slide the radiation shield over the thermo-hygrometer after connecting the cables from the wind speed sensor and rain gauge (Step 7). Attach to the thermo-hygrometer mounting arm to the upper mounting pole.

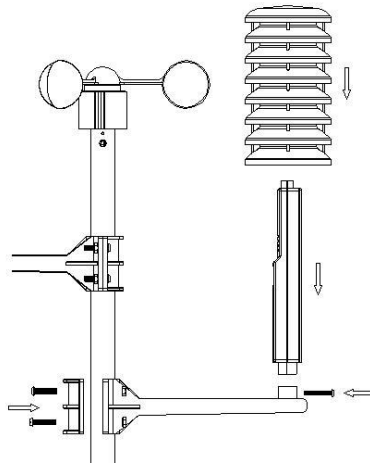

**Figure 3**

4. Connect the wind speed cable to the thermo-hygrometer jack (reference the label on the thermo-hygrometer). Connect the rain gauge cable to the thermo-hygrometer jack (reference the label on the thermo-hygrometer).

5. Insert two AA batteries in the thermo-hygrometer. The transmitter LED will light up momentarily (4 seconds), and then flash once every 48 seconds for each transmission update.

 **Note:** Do not install the batteries backwards. You can permanently damage the thermo-hygrometer.

Do not use rechargeable batteries.

 **Note:** We recommend installing Lithium AA batteries:

<http://www.ambientweather.com/enaaliba4pa.html>

Lithium batteries provide longer life and operate in colder temperatures.

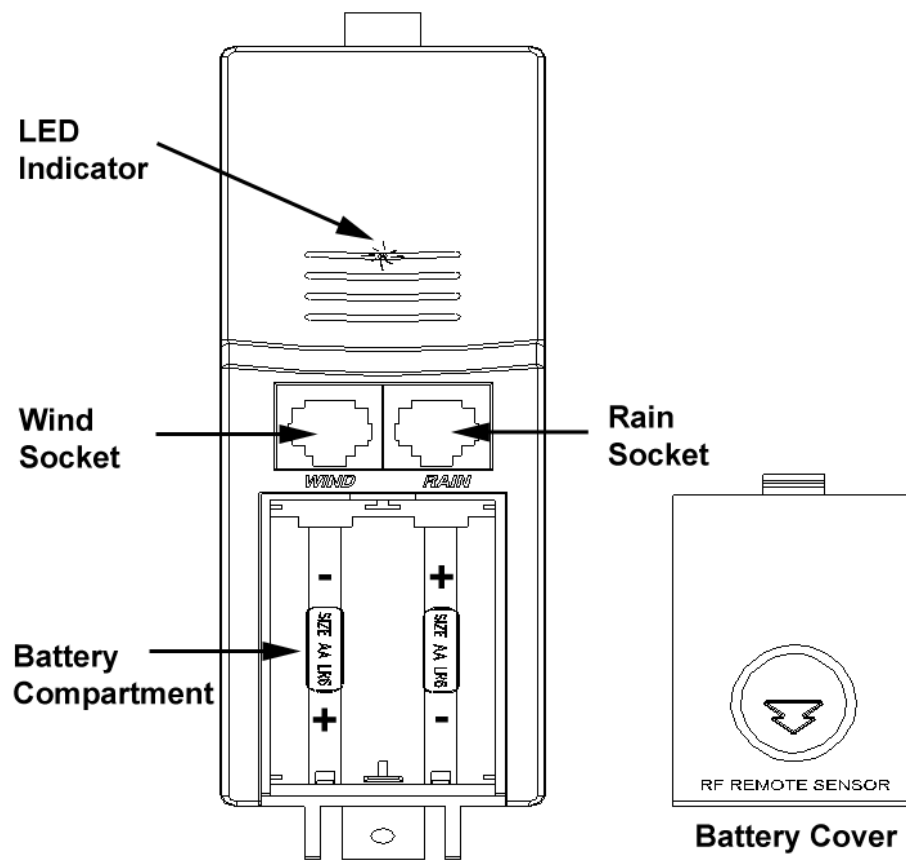
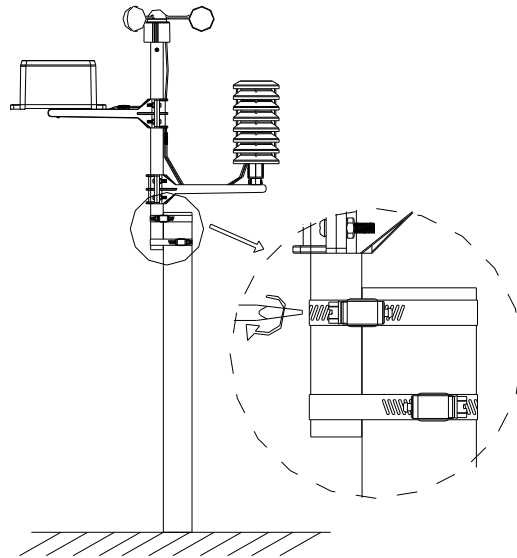

Figure 4

6. Fasten the lower mounting pole (which is swaged on the top end) to your mounting pole or bracket (purchased separately) with the hose clamps. Tighten the lower mounting pole to your mounting pole with the hose clamps with a flat head screw driver, as shown in Figure 5. Slide the top weather station pole (with the sensor array) into the lower pole (connected to your mounting pole) when your station is finally mounted.



**Figure 5**

7. Install the solar shield over the thermo-hygrometer/transmitter, and use the enclosed zip ties to clean up the cables.

## 3.4 Display Console

### 3.4.1 Display Console Layout

 **Note:** The presence of the "Alarm-On icon" in the section means that the particular alarm has been enabled.

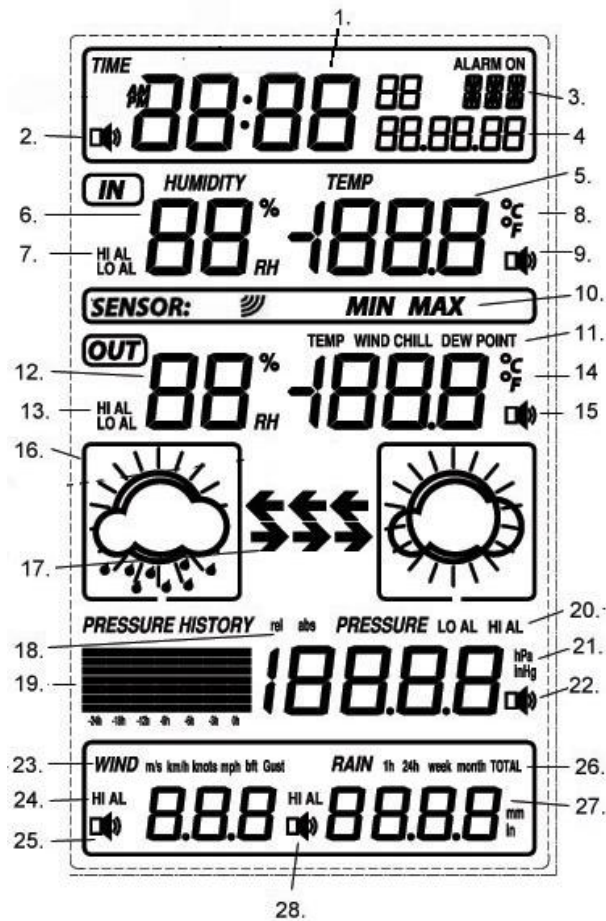



Figure 6

- |   |  |
|---|--|
| 1. Time   | 15. General outdoor alarm icon                                 |
| 2. Alarm on indicator   | 16. Weather forecast icon                                      |
| 3. Day of week/ time zone                                     | 17. Weather tendency indicator                                 |
| 4. Date   | 18. Pressure unit (relative or absolute)                       |
| 5. Indoor temperature display                                 | 19. Pressure with 24 hour history graph                        |
| 6. Indoor humidity display                                    | 20. Pressure low alarm and high alarm                          |
| 7. Indoor temperature and humidity low alarm and high alarm   | 21. Pressure display unit (inHg or hPa)                        |
| 8. Temperature display unit                                   | 22. Pressure alarm on indicator                                |
| 9. General indoor alarm icon                                  | 23. Wind speed display unit (m/s, km/h, knots, chill mph, bft) |
| 10. MIN/MAX information                                       | 24. Wind speed high alarm                                      |
| 11. Wind chill and dew point temperature display              | 25. Wind alarm on indicator                                    |
| 12. Outdoor temperature and humidity display                  | 26. Rainfall display unit (mm/in)                              |
| 13. Outdoor temperature and humidity low alarm and high alarm | 27. Rainfall 1h, 24h, week, month or total hour display        |
| 14. Temperature display unit                                  | 28. Rainfall alarm on indicator                                |



### 3.4.1 Initial Display Console Set Up

 **Note:** The sensor array must be powered and updating before powering up the console, or the console will give up searching for the sensors. Perform this step last.

Make certain the weather station sensor array is at least 10' away from the console and within 300' of the console. If the weather station is too close or too far away, it will not receive a proper signal.

Insert three AA batteries into the battery compartment on the back of the display. After inserting the batteries into the console, all of the LCD segments will light up for a few seconds to verify all segments are operating properly.

The unit will instantly display indoor temperature, humidity, barometer, tendency, date and time. The wind speed, rain, and outdoor temperature and humidity will update on the display within a few minutes. Do not touch the LCD until the outside transmitter report in, otherwise the outdoor sensor search mode will be terminated. When the outdoor transmitter data has been received, the console will automatically switch to the normal mode from which all further settings can be performed.

If it does not update, please reference the troubleshooting guide in Section 8.

### 3.4.2 Radio Controlled Clock (RCC)

After the remote sensor is powered up, the sensor will transmit weather data for 30 seconds, and then the sensor will begin radio controlled clock (RCC) reception. During the RCC time reception period (maximum 10 minutes), no weather data will be transmitted to avoid interference.

If the signal reception is not successful within 1 minute, the signal search will be cancelled and will automatically resume every two hours until the signal is successfully captured. The regular RF link will resume once RCC reception routine is finished. In some locations, RCC reception may take a couple of days to receive the signal.

### 3.4.3 Sensor Operation Verification

The following steps verify proper operation of the sensors prior to installing the sensor array.

1. **Verify proper operation of the rain gauge.** Tip the sensor array back and forth several times. You should hear a “clicking” sound within the rain gauge. Verify the rain reading on the display console is not reading 0.00. Each “click” represents 0.01 inches of rainfall.
2. **Verify proper operating of the wind speed.** Rotate the wind cups manually or with a fan. Verify the wind speed is not reading 0.0.
3. **Verify proper operation of the indoor and outdoor temperature.** Verify the indoor and outdoor temperature match closely with the console and sensor array in the same location (about 10' apart). The sensors should be within 4°F (2°C) (the accuracy is  $\pm 2^\circ\text{F} / 1^\circ\text{C}$ ). Allow about 30 minutes for both sensors to stabilize.
4. **Verify proper operation of the indoor and outdoor humidity.** Verify the indoor and outdoor humidity match closely with the console and sensor array in the same location (about 10' apart). The sensors should be within 8% (the accuracy is  $\pm 4\%$ ). Allow about 30 minutes for both sensors to stabilize.

---

## 4. Weather Station Installation

### 4.1 Pre Installation Checkout

Before installing your weather station in the permanent location, we recommend operating the weather station for one week in a temporary location with easy access. This will allow you to check out all of the functions, insure proper operation, and familiarize you with the weather station and calibration procedures. This will also allow you to test the wireless range of the weather station.

### 4.2 Site Survey

Perform a site survey before installing the weather station. Consider the following:

1. You must clean the rain gauge once per year and change the batteries every two years. Provide easy access to the weather station.
2. Avoid radiant heat transfer from buildings and structures. In general, install the sensor array at least 5' from any building, structure, ground, or roof top.
3. Avoid wind and rain obstructions. The rule of thumb is to install the sensor array at least four times the distance of the height of the tallest obstruction. For example, if the building is 20' tall, install  $4 \times 20' = 80'$  away. Use common sense. If the weather station is installed next to a tall building, the wind and rain will not be accurate.
4. Wireless Range. The radio communication between receiver and transmitter in an open field can reach a distance of up to 330 feet, providing there are no interfering obstacles such as buildings, trees, vehicles, high voltage lines. Wireless signals will not penetrate metal buildings.
5. Radio interference such as PCs, radios or TV sets can, in the worst case, entirely cut off radio communication. Please take this into consideration when choosing console or mounting locations.
6. Visit Ambient Weather Mounting Solutions for assistance and ideas for mounting your weather station:

<http://www.ambientweather.com/amwemoso.html>

### 4.3 Final Installation of Sensor Array

Mount the weather station in the permanent location. Confirm the weather station data is still updating on the display console.

## 5. Console Operation

 **Note:** The display console has five keys for basic operation: **SET** key, **+** key, **HISTORY** key, **ALARM** key and **MIN/MAX** key.

### 5.1 Set Mode

While in the normal mode, press the **SET** key for 3 seconds to enter the Set Mode. The Set mode can be exited at any time by either pressing the **HISTORY** key or waiting for the 10-second time-out to take effect. You can skip over any setting by pressing the **SET** key again.

Holding the **+** key (increase) or **MIN/MAX** key (decrease) when in the Set mode will change values rapidly.

## 5.1.1 Set Time

1. **Time Zone.** The time zone value will begin flashing.

Press the **[+]** key (increase) or **[MIN/MAX]** key (decrease) to adjust the time zone from -12 to 12, based on the number of hours from Coordinated Universal Time, or Greenwich Mean Time (GMT).

The following table provides times zones throughout the world. Locations in the eastern hemisphere are positive, and locations in the western hemisphere are negative.

Hours from GMT	Time Zone	Cities
-12	IDLW: International Date Line West	---
-11	NT: Nome	Nome, AK
-10	AHST: Alaska-Hawaii Standard CAT: Central Alaska HST: Hawaii Standard	Honolulu, HI
-9	YST: Yukon Standard	Yukon Territory
-8	PST: Pacific Standard	Los Angeles, CA, USA
-7	MST: Mountain Standard	Denver, CO, USA
-6	CST: Central Standard	Chicago, IL, USA
-5	EST: Eastern Standard	New York, NY, USA
-4	AST: Atlantic Standard	Caracas
-3	---	São Paulo, Brazil
-2	AT: Azores	Azores, Cape Verde Islands
-1	WAT: West Africa	---
0	GMT: Greenwich Mean WET: Western European	London, England
1	CET: Central European	Paris, France
2	EET: Eastern European	Athens, Greece
3	BT: Baghdad	Moscow, Russia
4	---	Abu Dhabi, UAE
5	---	Tashkent
6	---	Astana
7	---	Bangkok
8	CCT: China Coast	Beijing
9	JST: Japan Standard	Tokyo
10	GST: Guam Standard	Sydney
11	---	Magadan
12	IDLE: International Date Line East NZST: New Zealand Standard	Wellington, New Zealand

2. **12/24 Hour Format.** Press the **[SET]** key to change the 12/24 hour format. Press the **[+]** key to alternate the display unit between 12 hour format and 24 hour format.
3. **Change Hour.** Press the **[SET]** key to set the hour. Press the **[+]** key or **[MIN/MAX]** key to change the hour setting. Manually setting the time overrides the automatic RCC time.
4. **Change Minute.** Press the **[SET]** key to set the minute. Press the **[+]** key or **[MIN/MAX]** key to change the minute setting. Manually setting the time overrides the automatic RCC time.

### 5.1.2 Set Date

1. **Change Year.** Press the **SET** key to set the year. The year will begin flashing. Press the **+** key or **MIN/MAX** key to change the year setting.
2. **Change Month.** Press the **SET** key to set the month. The month will begin flashing. Press the **+** key or **MIN/MAX** key to change the month setting.
3. **Change Day.** Press the **SET** key to set the day. The day will begin flashing. Press the **+** key or **MIN/MAX** key to change the day setting.

### 5.1.3 Set Indoor Temperature and Outdoor Temperature Units

**Change Indoor Temperature Units.** Press the **SET** key to set the indoor and outdoor temperature units. The indoor and outdoor temperature will begin flashing. Press the **+** to alternate the display unit between °C and °F.

### 5.1.4 Set Barometric Pressure

 **Note:** The weather station console displays two different pressures: absolute (measured) and relative (corrected to sea-level).

To compare pressure conditions from one location to another, meteorologists correct pressure to sea-level conditions. Because the air pressure decreases as you rise in altitude, the sea-level corrected pressure (the pressure if you were located at sea-level) is generally higher than your measured pressure.

Thus, your absolute pressure may read 28.62 inHg (969 mb) at an altitude of 1000 feet (305 m), but the relative pressure is 30.00 inHg (1016 mb).

The standard sea-level pressure is 29.92 in Hg (1013 mb). This is the average sea-level pressure around the world. Relative pressure measurements greater than 29.92 inHg (1013 mb) are considered high pressure and relative pressure measurements less than 29.92 inHg are considered low pressure.

To determine the relative pressure for your location, locate an official reporting station near you (the internet is best source for real time barometer conditions, such as Weather.com or Wunderground.com), and set your weather station to match the official reporting station.

1. **Pressure Units.** Press the **SET** key to set the pressure units. The pressure units will begin flashing. Press the **+** key to alternate between in Hg and hPa.
2. **Relative vs. Absolute Pressure Display.** Press the **+** key to alternate the display between relative (rel) pressure and absolute (abs) pressure.
3. **Relative Pressure Calibration.** Press the **SET** key to set the relative pressure. The relative pressure will flash. Press the **+** key or **MIN/MAX** key to change the relative pressure.
4. **Pressure Threshold.** Press the **SET** key to change the pressure threshold. The pressure threshold will be flashing. Press the **+** key to adjust the pressure threshold from 2.0 to 4.0 hPa/hr (the default is 2 hPa/hr).
5. **Storm Threshold.** Press the **SET** key to change the storm threshold. The storm threshold will

be flashing. Press the **+** key to adjust the pressure threshold from 3.0 to 9.0 hPa/hr (the default is 4 hPa/hr).

### 5.1.5 Set Wind Units

**Wind Units.** Press the **SET** key to set the wind units. The wind will begin flashing. Press the **+** key to alternate the display unit between km/h, mph, m/s, knots, and bft (or Beaufort scale).

### 5.1.5 Set Rain Units

**Rain Units.** Press the **SET** key to set the rain units. The rain will begin flashing. Press the **+** key to alternate the display unit between in and mm.

## 5.2 Quick Set Mode

While in the Normal mode, press the **SET** key to enter the Quick Set Mode. The Quick Set mode can be exited at any time by either pressing the **HISTORY** key or waiting for the 10-second time-out to take effect. You can skip over any setting by pressing the **SET** key again.

Holding the **+** key (increase) or **MIN/MAX** key (decrease) when in the Set mode will change values rapidly.

### 5.2.1 Outdoor Temperature, Wind chill and Dew Point Display

**Outdoor Temperature, Wind Chill and Dew Point Display.** The outdoor temperature will begin flashing. Press the **+** key to alternate the display between the outdoor temperature, wind chill and dew point.

### 5.2.2 Relative and Absolute Pressure Display

**Relative and Absolute Pressure Display.** Press the **SET** key to change the pressure display. The pressure will begin flashing. Press the **+** key to alternate the display between absolute and relative pressure.

### 5.2.3 Average Wind Speed and Wind Gust

**Average Wind Speed and Gust.** Press the **SET** key to change the wind speed display. The wind speed will begin flashing. Press the **+** key to alternate the display between the 48 second Wind Average Speed and Gust Speed (or the maximum wind speed in the update period, which is 48 seconds).

### 5.2.4 Rain Display and Reset

1. **Rain Increment Display.** Press the **SET** key to change the rain increment display. The rain will begin flashing. Press the **+** key to alternate the display between the 1 hour rain, 24 hour rain, weekly monthly rain, and total rain (since reset).
2. **Total Rain Reset.** With the total rain flashing in the previous step, press and hold the **SET** key for three seconds, and the total rain will reset to zero.

## 5.3 History Mode

While in the Normal mode, press the **HISTORY** key to enter the History mode.

Select the  key to review historical data archived in the console in increments of two hours (-24, -22, -20, -18, -16, -14, -10, -8, -6, -4 and -2 hours).



## 5.4 Alarm Mode

 **Note:** After initially pressing the **ALARM** key, the display will show the current high and low alarm values. The alarm value will be displayed only for those already activated, otherwise, inactive alarms will show dashes (--).

The Alarm mode can be exited at any time by either pressing the **ALARM** key or waiting for the 10-second time-out to take effect.

### 5.4.1 High Alarm Mode

While in the Normal mode, press the **ALARM** key to enter the High Alarm mode. The **HIAL** icon will be displayed in the **TIME** section.

1. **Time of Day Alarm.** Press the **SET** key to set the hour of day alarm. The hour will begin flashing. Press the  key (increase) or **MIN/MAX** key (decrease) to change the hour value. Press the **SET** key again to set the minute value. The minute will begin flashing. Press the  key or **MIN/MAX** key to increase or decrease the minute value.

Press the **ALARM** key to turn the alarm on or off (if the alarm is enabled, the alarm icon  will be turned on).

2. **Indoor Humidity High Alarm.** Press the **SET** key to set the indoor humidity high alarm. The indoor humidity will begin flashing. Press the  key (increase) or **MIN/MAX** key (decrease) to change the indoor humidity alarm value.

Press the **ALARM** key to turn the alarm on or off (if the alarm is enabled, the alarm icon  will be turned on and the HI AL icon will be displayed).

3. **Indoor Temperature High Alarm.** Press the **SET** key to set the indoor temperature high alarm. The indoor temperature will begin flashing. Press the  key (increase) or **MIN/MAX** key (decrease) to change the indoor temperature alarm value.

Press the **ALARM** key to turn the alarm on or off (if the alarm is enabled, the alarm icon  will be turned on and the HI AL icon will be displayed).

4. **Outdoor Humidity High Alarm.** Press the **SET** key to set the outdoor humidity high alarm. The outdoor humidity will begin flashing. Press the  key (increase) or **MIN/MAX** key (decrease) to change the outdoor humidity alarm value.

Press the **ALARM** key to turn the alarm on or off (if the alarm is enabled, the alarm icon  will be turned on and the HI AL icon will be displayed).

5. **Outdoor Temperature High Alarm.** Press the **SET** key to set the outdoor temperature high alarm. The **TEMP** icon will be displayed and the outdoor temperature will begin flashing.

Press the **[+]** key (increase) or **[MIN/MAX]** key (decrease) to change the outdoor temperature alarm value.

Press the **[ALARM]** key to turn the alarm on or off (if the alarm is enabled, the alarm icon  will be turned on and the HI AL icon will be displayed).

6. **Wind Chill High Alarm.** Press the **[SET]** key to set the wind chill high alarm. The **WIND CHILL** icon will be displayed and the outdoor temperature (wind chill) will begin flashing. Press the **[+]** key (increase) or **[MIN/MAX]** key (decrease) to change the wind chill alarm value.

Press the **[ALARM]** key to turn the alarm on or off (if the alarm is enabled, the alarm icon  will be turned on and the HI AL icon will be displayed).

7. **Dew Point High Alarm.** Press the **[SET]** key to set the dew point high alarm. The **DEW POINT** icon will be displayed and the outdoor temperature (dew point) will begin flashing. Press the **[+]** key (increase) or **[MIN/MAX]** key (decrease) to change the dew point alarm value.

Press the **[ALARM]** key to turn the alarm on or off (if the alarm is enabled, the alarm icon  will be turned on and the HI AL icon will be displayed).

8. **Barometric Pressure High Alarm.** Press the **[SET]** key to set the barometric pressure high alarm. The barometric pressure will begin flashing. Press the **[+]** key (increase) or **[MIN/MAX]** key (decrease) to change the barometric pressure alarm value.

Press the **[ALARM]** key to turn the alarm on or off (if the alarm is enabled, the alarm icon  will be turned on and the HI AL icon will be displayed).

9. **Wind Speed High Alarm.** Press the **[SET]** key to set the wind speed high alarm. The wind speed will begin flashing. Press the **[+]** key (increase) or **[MIN/MAX]** key (decrease) to change the wind speed alarm value.

Press the **[ALARM]** key to turn the alarm on or off (if the alarm is enabled, the alarm icon  will be turned on and the HI AL icon will be displayed).

10. **Wind Gust High Alarm.** Press the **[SET]** key to set the wind gust high alarm. The **GUST** icon will be displayed and the wind speed will begin flashing. Press the **[+]** key (increase) or **[MIN/MAX]** key (decrease) to change the wind gust alarm value.

Press the **[ALARM]** key to turn the alarm on or off (if the alarm is enabled, the alarm icon  will be turned on and the HI AL icon will be displayed).

11. **1 Hour Rain Alarm.** Press the **[SET]** key to set the 1 hour rain alarm. The rain will begin flashing. Press the **[+]** key (increase) or **[MIN/MAX]** key (decrease) to change the 1 hour rain alarm value.

Press the **[ALARM]** key to turn the alarm on or off (if the alarm is enabled, the alarm icon  will be turned on and the HI AL icon will be displayed).

12. **24 Hour Rain Alarm.** Press the **[SET]** key to set the 24 hour rain alarm. The rain will begin flashing. Press the **[+]** key (increase) or **[MIN/MAX]** key (decrease) to change the 24 hour

rain alarm value.

Press the **ALARM** key to turn the alarm on or off (if the alarm is enabled, the alarm icon  will be turned on and the HI AL icon will be displayed).

### 5.4.2 Low Alarm Mode

While in the Normal mode, press the **ALARM** key twice to enter the Low Alarm mode. The **LOAL** icon will be displayed in the **TIME** section.

1. **Time of Day Alarm.** Reference Section 5.4.1.
2. **Indoor Humidity Low Alarm.** Reference Section 5.4.1. The low alarm is similar to the high alarm setting.
3. **Indoor Temperature Low Alarm.** Reference Section 5.4.1. The low alarm is similar to the high alarm setting.
4. **Outdoor Humidity Low Alarm.** Reference Section 5.4.1. The low alarm is similar to the high alarm setting.
5. **Outdoor Temperature Low Alarm.** Reference Section 5.4.1. The low alarm is similar to the high alarm setting.
6. **Wind Chill Low Alarm.** Reference Section 5.4.1. The low alarm is similar to the high alarm setting.
7. **Dew Point Low Alarm.** Reference Section 5.4.1. The low alarm is similar to the high alarm setting.
8. **Barometric Pressure Low Alarm.** Reference Section 5.4.1. The low alarm is similar to the high alarm setting.

### 5.4.3 Cancelling an Alarm

When a weather alarm condition has been triggered, the alarm will sound for 120 second and flash until the weather condition is no longer valid. Press any key to silence the alarm.

The alarm will reactivate automatically once the value has exceeded the alarm limit again. To avoid repeated alarms, you should disable the alarm function or set it to a new value.

### 5.4.4 Outdoor Temperature/ Wind Chill / Dew Point Alarm

When an alarm has been triggered, it will flash on the LCD display and the general outdoor alarm icon and high/low alarm icon will flash accordingly.

For example, when the dew point high alarm is triggered, the **DEW POINT** icon will flash along with general outdoor alarm icon and high alarm icon flashing , as shown in Figure 7.



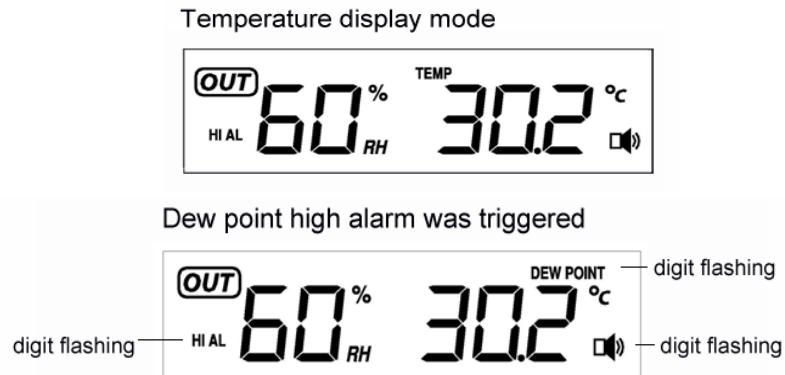

Figure 7

## 5.5 Min/Max Mode

While in the Normal mode, press the **MIN/MAX** key to enter the **Maximum** mode. The maximum values will begin flashing.

Press the **MIN/MAX** key again to enter the **Minimum** mode. The minimum values will begin flashing.

The Min/Max mode can be exited at any time by either pressing the **HISTORY** key or waiting for the 10-second time-out to take effect. You can skip over any setting by pressing the **+** key again.

### 5.5.1 Maximum Mode

1. **Maximum Indoor Humidity.** Press the **+** key to display the maximum indoor humidity with the associated time and date stamp.

Press the **SET** key to reset the maximum indoor humidity to the current value, date and time.

2. **Maximum Indoor Temperature.** Press the **+** key to display the maximum indoor temperature with the associated time and date stamp.

Press the **SET** key to reset the maximum indoor temperature to the current value, date and time.

3. **Maximum Outdoor Humidity.** Press the **+** key to display the maximum outdoor humidity with the associated time and date stamp.

Press the **SET** key to reset the maximum outdoor humidity to the current value, date and time.

4. **Maximum Outdoor Temperature.** Press the **+** key to display the maximum outdoor

temperature with the associated time and date stamp.

Press the **SET** key to reset the maximum outdoor temperature to the current value, date and time.

5. **Maximum Wind Chill.** Press the **+** key to display the maximum wind chill with the associated time and date stamp.

Press the **SET** key to reset the maximum wind chill to the current value, date and time.

6. **Maximum Dew Point.** Press the **+** key to display the maximum dew point with the associated time and date stamp.

Press the **SET** key to reset the maximum dew point to the current value, date and time.

7. **Maximum Pressure.** Press the **+** key to display the maximum pressure with the associated time and date stamp.

Press the **SET** key to reset the maximum pressure to the current value, date and time.

8. **Maximum Wind Speed.** Press the **+** key to display the maximum wind speed with the associated time and date stamp.

Press the **SET** key to reset the maximum wind speed to the current value, date and time.

9. **Maximum Wind Gust.** Press the **+** key to display the maximum wind gust with the associated time and date stamp.

Press the **SET** key to reset the maximum wind gust to the current value, date and time.

## 5.5.2 Minimum Mode

1. **Minimum Indoor Humidity.** Reference Section 5.5.1. The minimum setting is similar to the maximum setting.

2. **Minimum Indoor Temperature.** Reference Section 5.5.1. The minimum setting is similar to the maximum setting.

3. **Minimum Outdoor Humidity.** Reference Section 5.5.1. The minimum setting is similar to the maximum setting.

4. **Minimum Outdoor Temperature.** Reference Section 5.5.1. The minimum setting is similar to the maximum setting.

5. **Minimum Wind Chill.** Reference Section 5.5.1. The minimum setting is similar to the maximum setting.

6. **Minimum Dew Point.** Reference Section 5.5.1. The minimum setting is similar to the maximum setting.

7. **Minimum Pressure.** Reference Section 5.5.1. The minimum setting is similar to the maximum setting.

## 5.6 Other Console Features

The following section describes additional console features.

### 5.6.1 Weather Forecasting



**Note:** The weather forecast or pressure tendency is based on the rate of change of barometric pressure. In general, when the pressure increases, the weather improves (sunny to partly cloudy) and when the pressure decreases, the weather degrades (cloudy to rain).

The weather forecast is an estimation or generalization of weather changes in the next 24 to 48 hours, and varies from location to location. The tendency is simply a tool for projecting weather conditions and is never to be relied upon as an accurate method to predict the weather.

### 5.6.2 Weather Icons

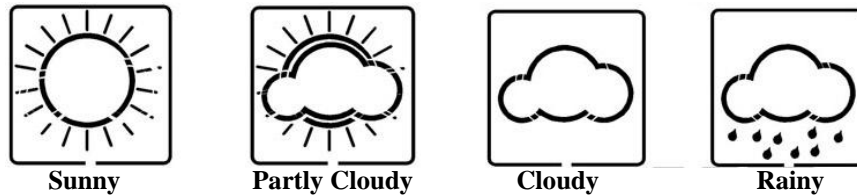

The four weather icons are Sunny, Partly Cloudy, Cloudy and Rainy. There are also two weather tendency indicators to show the air pressure tendency between the weather icons.

### 5.6.3 Weather tendency indicator

The weather tendency arrow is located between the weather icons to show the air pressure tendency and provide a forecast based on increasing or decreasing air pressure.

The arrow pointing to the right indicates that the air pressure is increasing and the weather is expected to improve. The arrow pointing the left indicates that the air pressure is decreasing and the weather is expected to deteriorate.

The weather tendency is based on the pressure change since last six hours. If the weather is changing, the weather tendency indicator (animated arrows) will flash for three hours, indicating the weather is expected to change. If the weather conditions become stable and no new weather change conditions are met, then the arrows will be fixed.

**Example 1:** Pressure is decreasing, weather is deteriorating.

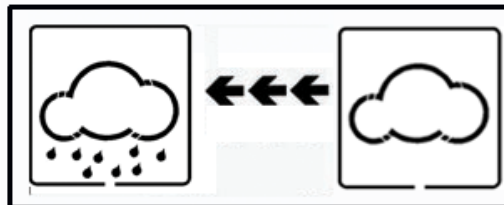

**Example 2:** Pressure is increasing, weather is improving.

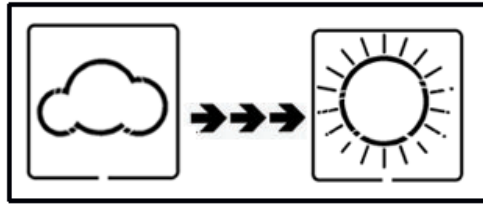

#### 5.6.4 Storm threshold indicator

The storm threshold (the negative rate of pressure change signifying a storm is expected) can be adjusted by the user from level 3 to level 9 (the default level 4).

When negative rate of change of pressure is exceeded for 3 hours, the storm warning indicator will be activated, and the clouds with rain icon and tendency arrows will flash for 3 hours indicating the storm warning feature has been activated.

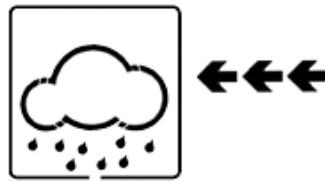

#### 5.6.5 Pressure threshold setting

The pressure threshold (the negative or positive rate of change of pressure signifying a change in the weather) can be adjusted by the user from level 2 to level 4 (default level 2).

The lower the level pressure threshold setting, the higher sensitivity for weather forecast changes. Locations that experience frequent changes in air pressure require a higher setting compared to locations where the air pressure is typically stagnant.

#### 5.6.6 Pressure Graph

 **Note:** The weather station bar graph flashes from left to right to prevent screen burn in. This feature cannot be turned off.

The pressure graph displays the barometric pressure for the last 24 hours. Each bar represents three hours.

## 6. Glossary of Terms

Term	Definition
Absolute Barometric Pressure	Relative barometric pressure, corrected to sea-level. To compare pressure conditions from one location to another, meteorologists correct pressure to sea-level conditions. Because the air pressure decreases as you rise in altitude, the sea-level corrected pressure (the pressure your location would be at if located at sea-level) is generally higher than your measured pressure.

<b>Term</b>	<b>Definition</b>
Accuracy	Accuracy is defined as the ability of a measurement to match the actual value of the quantity being measured.
Hecto Pascals (hPa)	Pressure units in SI (international system) units of measurement. Same as millibars (1 hPa = 1 mbar)
Hygrometer	A hygrometer is a device that measures relative humidity. Relative humidity is a term used to describe the amount or percentage of water vapor that exists in air.
Inches of Mercury (inHg)	Pressure in Imperial units of measure. 1 inch of mercury = 33.86 millibars
Range	Range is defined as the amount or extent a value can be measured.
Relative Barometric Pressure	Measured barometric pressure relative to your location or ambient conditions.
Resolution	Resolution is defined as the number of significant digits (decimal places) to which a value is being reliably measured.

## 7. Specifications

### 7.1 Wireless Specifications

- Line of sight wireless transmission (in open air): 300 feet
- Update Rate: 48 seconds

### 7.2 Measurement Specifications

The following table provides the specifications for the measured parameters.

<b>Measurement</b>	<b>Range</b>	<b>Accuracy</b>	<b>Resolution</b>
Indoor Temperature	32 to 140 °F	± 2 °F	0.1 °F
Outdoor Temperature	-40 to 149 °F	± 2 °F	0.1 °F
Indoor Humidity	10 to 99 %	± 4%	1 %
Outdoor Humidity	10 to 99%	± 4%	1 %
Barometric Pressure	8.85 to 32.50 inHg	± 0.08 inHg (within range of 27.13 to 32.50 inHg)	0.01 inHg
Rain	0 to 394 in.	± 10%	0.01 in
Wind Speed	0 to 112 mph	± 2.2 mph or 10% (whichever is greater)	0.1 mph

### 7.3 Power Consumption

- Base station : 3XAA 1.5V LR6 Alkaline batteries
- Remote sensor : 2xAA 1.5V LR6 Alkaline batteries
- Battery life: Minimum 12 months for base station  
Minimum 24 months for thermo-hygro sensor (use lithium batteries in cold weather climates)

### 7.4 Cable Lengths

- Anemometer to Thermo-Hygrometer-Transmitter: 8.5 feet
- Rain Gauge to Thermo-Hygrometer-Transmitter: 8.5 feet

## 8. Troubleshooting Guide

If your question is not answered here, you can contact us as follows:



1. Email Support: [support@ambientweather.com](mailto:support@ambientweather.com)
2. Live Chat Support: [www.ambientweather.com/chat.html](http://www.ambientweather.com/chat.html) (M-F 8am to 4pm Arizona Time)
3. Technical Support: 480-283-1644 (M-F 8am to 4pm Arizona Time)

<b>Problem</b>	<b>Solution</b>
<p>Wireless remote (thermo-hygrometer) not reporting in to console.</p> <p>There are dashes on the display console.</p>	<p>The maximum line of sight communication range is 300'. Move the sensor assembly closer to the display console.</p> <p>If the sensor assembly is too close (less than 10'), move the sensor assembly away from the display console.</p> <p>Cycle power on the console. The console may have exited the search mode.</p> <p>Install a fresh set of batteries in the remote thermo-hygrometer. For cold weather environments, install lithium batteries.</p> <p>Make sure the remote sensors are not transmitting through solid metal (acts as an RF shield), or earth barrier (down a hill).</p> <p>Move the display console around electrical noise generating devices, such as computers, TVs and other wireless transmitters or receivers.</p> <p>Move the remote sensor to a higher location.</p> <p>Radio Frequency (RF) Sensors cannot transmit through metal barriers (example, aluminum siding) or multiple, thick walls.</p>
<p>Temperature sensor reads too high in the day time.</p>	<p>In hot weather climates, the rain guard and solar shield may not be effective enough. Consider the following radiation shield:  <a href="http://www.ambientweather.com/amwesrpatcan.html">http://www.ambientweather.com/amwesrpatcan.html</a></p>
<p>Indoor and Outdoor Temperature do not agree</p>	<p>Allow up to one hour for the sensors to stabilize due to signal filtering. The indoor and outdoor temperature sensors should agree within 4 °F (the sensor accuracy is <math>\pm 2</math> °F)</p>
<p>Indoor and Outdoor Humidity do not agree</p>	<p>Allow up to one hour for the sensors to stabilize due to signal filtering. The indoor and outdoor humidity sensors should agree within 10 % (the sensor accuracy is <math>\pm 5</math> %)</p>
<p>Absolute pressure does not agree with official reporting station</p>	<p>You may be viewing the relative pressure, not the absolute pressure.</p>

Problem	Solution
	<p>Select the absolute pressure. Make sure you properly calibrate the sensor to an official local weather station. Reference Section 5.1.4 for details.</p> <p>The barometer is only accurate to <math>\pm 0.08</math> inHg within the following relative pressure range: 27.13 to 32.50 inHg, which corresponds to an altitude of -2,200 to 2,700 feet. At higher altitudes, expect some non-linearity or error.</p>
Rain gauge reports rain when it is not raining	An unstable mounting solution (sway in the mounting pole) may result in the tipping bucket incorrectly incrementing rainfall. Make sure you have a stable mounting solution. Move the rain gauge from the pole mount to a flat, stable mount (fixed, flat structure).
Barometer graph flashes. Can I turn this off?	No, this feature prevents burn in of the display monitor.
Wind speed appears low	Average wind speed may have the appearance of low wind. Try switching the display to wind gust.
Can the lamp be turned on all of time?	No, to prevent the bulb from burning out, it can only turn on temporarily.
The forecast icon is not accurate	<p>The weather station console must run for several days to trend barometric pressure.</p> <p>The weather forecast is an estimation or generalization of weather changes in the next 24 to 48 hours, and varies from location to location. The tendency is simply a tool for projecting weather conditions and is never to be relied upon as an accurate method to predict the weather.</p>

## 9. Accessories

The following software and hardware accessories are available for this weather station at [www.AmbientWeather.com](http://www.AmbientWeather.com).

Accessory	Image	Description
<a href="#">BCY29 4 in 1 Pocket Precision Screwdriver</a>		This precision screwdriver kit is a must for assembling this weather station due to the small, precision screws.
<a href="#">Weather Station Mounting Solutions</a>		Pole mounting solutions, tripods, mast to mast mounting kits. The WS-1070 pole mount can be attached to a pole mounting solution with the included hose clamps.
<a href="#">Energizer AA Lithium Battery (2-pack) - Batteries for Long Life and Cold Climates</a>		AA lithium batteries for cold weather climates.

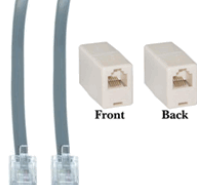
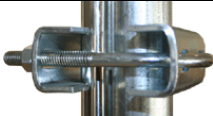
Accessory	Image	Description
<a href="#">SRS100LX Temperature and Humidity Solar Radiation Shield</a>		Solar Radiation Shield improves temperature accuracy for hot weather climates. Remove the rain guard and install over thermo-hygrometer.
<a href="#">Cable Extensions</a>		Cable extension kits allow you to extend the cables between the anemometer and rain gauge to the thermo-hygrometer, improving the flexibility of the installation.
<a href="#">Ambient Weather P2P2 Mast to Mast Mounting Kit</a>		The P2P2 mast to mast reduction kit is used with any of Ambient Weather's mounting pole kits, and allows you to mount smaller diameter poles to larger diameter poles, providing a solid mounting solution. Replaces hose clamps included with weather station for improved mounting stability.

## 10. Liability Disclaimer

Please help in the preservation of the environment and return used batteries to an authorized depot. The electrical and electronic wastes contain hazardous substances. Disposal of electronic waste in wild country and/or in unauthorized grounds strongly damages the environment.

Reading the “User manual” is highly recommended. The manufacturer and supplier cannot accept any responsibility for any incorrect readings and any consequences that occur should an inaccurate reading take place.

This product is designed for use in the home only as indication of weather conditions. This product is not to be used for medical purposes or for public information.

The specifications of this product may change without prior notice.

This product is not a toy. Keep out of the reach of children.

No part of this manual may be reproduced without written authorization of Ambient, LLC.

Ambient, LLC WILL NOT ASSUME LIABILITY FOR INCIDENTAL, CONSEQUENTIAL, PUNITIVE, OR OTHER SIMILAR DAMAGES ASSOCIATED WITH THE OPERATION OR MALFUNCTION OF THIS PRODUCT.

## 11. FCC Statement

### Statement according to FCC part 15.19:

This device complies with part 15 of the FCC rules. Operation is subject to the following two conditions:

1. This device may not cause harmful interference.
2. This device must accept any interference received, including interference that may cause undesired operation.



---

**Statement according to FCC part 15.21:**

Modifications not expressly approved by this company could void the user's authority to operate the equipment.

**Statement according to FCC part 15.105:**

NOTE: This equipment has been tested and found to comply with the limits for a Class B digital device, pursuant to Part 15 of the FCC Rules. These limits are designed to provide reasonable protection against harmful interference in a residential installation. This equipment generates, uses and can radiate radio frequency energy and, if not installed and used in accordance with the instructions, may cause harmful interference to radio communications.

However, there is no guarantee that interference will not occur in a particular installation. If this equipment does cause harmful interference to radio or television reception, which can be determined by turning the equipment off and on, the user is encouraged to try to correct the interference by one or more of the following measures:

- Reorient or relocate the receiving antenna.
- Increase the separation between the equipment and receiver.
- Connect the equipment into an outlet on a circuit different from that to which the receiver is connected.
- Consult the dealer or an experienced radio/TV technician for help.

## 12. Warranty Information

Ambient, LLC provides a 1-year limited warranty on this product against manufacturing defects in materials and workmanship.

This limited warranty begins on the original date of purchase, is valid only on products purchased and only to the original purchaser of this product. To receive warranty service, the purchaser must contact Ambient, LLC for problem determination and service procedures.

Warranty service can only be performed by Ambient, LLC. The original dated bill of sale must be presented upon request as proof of purchase to Ambient, LLC.

Your Ambient, LLC warranty covers all defects in material and workmanship with the following specified exceptions: (1) damage caused by accident, unreasonable use or neglect (lack of reasonable and necessary maintenance); (2) damage resulting from failure to follow instructions contained in your owner's manual; (3) damage resulting from the performance of repairs or alterations by someone other than an authorized Ambient, LLC authorized service center; (4) units used for other than home use (5) applications and uses that this product was not intended (6) the products inability to receive a signal due to any source of interference or metal obstructions and (7) extreme acts of nature, such as lightning strikes or floods.

This warranty covers only actual defects within the product itself, and does not cover the cost of installation or removal from a fixed installation, normal set-up or adjustments, claims based on misrepresentation by the seller or performance variations resulting from installation-related circumstances.

