Ambient Weather WS-1080/WS-1090 Wireless Home Weather Station User Manual



Table of Contents

1.	Introduction	2
2.	Warnings and Cautions.....	2
3.	Getting Started	2
3.1	Parts List.....	2
3.2	Recommend Tools.....	3
3.3	Sensor Assembly Set Up	3
3.4	Display Console	10
3.4.1	Display Console Layout.....	10
3.4.1	Initial Display Console Set Up.....	11
3.4.2	Sensor Operation Verification	12
3.4.3	Radio Controlled Clock (WS-1090 only).....	12
4.	Weather Station Installation	12
4.1	Pre Installation Checkout	12
4.2	Site Survey	12
4.3	Final Installation of Sensor Array.....	13
5.	Console Operation.....	13
5.1	Indoor Temperature	13
5.2	Outdoor Temperature, Wind Chill and Dew Point	14
5.3	Indoor Humidity	15
5.4	Outdoor Humidity	16
5.5	Wind Speed	17
5.6	Rain	17
5.7	Weather Forecast (Tendency)	18
5.8	Barometric Pressure	19
5.9	Pressure Graph	21
5.10	Time	21
5.11	Date	22
5.12	Memory	23
6.	PC Software	24
6.1	EasyWeather Overview	24
6.2	Connect PC Connection	25
6.3	EasyWeather Software Installation.....	25
6.4	Run EasyWeather	25
6.5	EasyWeather Features	25
6.5.1	Main Display.....	25
6.5.2	Set-up and Alarms	26
6.5.3	Alarm Values	27
6.5.4	Historical Highs and Lows.....	28
6.5.5	Historical Data	29
6.5.6	Graph Data	30
6.5.7	EasyWeather Legal Notes	31
7.	Glossary of Terms	31

8.	Specifications.....	32
8.1	Wireless Specifications	32
8.2	Measurement Specifications.....	32
8.3	Power Consumption	32
8.4	Cable Lengths.....	32
9.	Maintenance.....	33
10.	Troubleshooting Guide.....	33
11.	Accessories.....	35
12.	Liability Disclaimer.....	36
13.	FCC Statement.....	37
14.	Warranty Information	37

1. Introduction

Thank you for your purchase of the Ambient Weather WS-1080/WS-1090 wireless weather station. The following user guide provides step by step instructions for installation, operation and troubleshooting. To download the latest manual and additional troubleshooting tips, please visit:

<http://ambientweather.wikispaces.com/ws1080>

2. Warnings and Cautions

⚠ Warning: Any metal object may attract a lightning strike, including your weather station mounting pole. Never install the weather station in a storm.

⚠ Warning: Installing your weather station in a high location may result in injury or death. Perform as much of the initial check out and operation on the ground and inside a building or home. Only install the weather station on a clear, dry day.

3. Getting Started

The WS-1080 weather station consists of a display console (receiver), a thermo-hygrometer transmitter unit, a wind direction sensor, a wind speed sensor, a rain gauge, mounting hardware, USB cable and a PC software package on CD-ROM.

3.1 Parts List

QTY	Item
1	Display Console Frame Dimensions (LxWxH): 9" x 5 3/4" x 1 1/4" LCD Dimensions (LxW): 5 3/4" x 4 1/4"
1	Thermo-hygrometer transmitter
1	Thermo-hygrometer transmitter mounting bracket
1	Thermo-hygrometer transmitter radiation shield
1	Wind direction sensor
1	Wind speed sensor
1	Anemometer mounting arm (L: 12")

1	Rain gauge
1	Rain gauge mounting bracket
1	USB cable (L: 41")
1	Easy Weather CD
3	1" nuts and bolts (long)
1	13/16" bolt (short)
1	1/2" set screw (long)
1	3/8" set screw (short) (Optional)
1	Upper pole (L: 12")
1	Lower pole (L: 12")
4	Zip ties
2	Hose clamps (2 3/4" diameter)

3.2 Recommend Tools

- Precision screwdriver (for small Phillips screws)
- Pliers
- Phillips screwdriver
- Flat blade screwdriver
- Tack (small) hammer or rubber mallet
- Compass or GPS (for wind direction calibration)

3.3 Sensor Assembly Set Up

1. Connect the wind cup assembly to either end of the anemometer mounting arm. Align the holes, and fasten with long bolt and nut. Tighten with precision screwdriver while securing the nut with pliers, as shown in Figure 1.

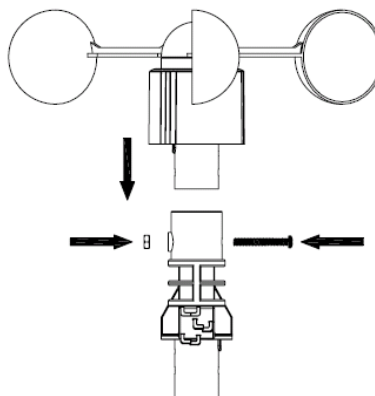

①

Figure 1

2. Connect the wind vane assembly to the other end of the anemometer mounting arm. Align the holes, and fasten with long bolt and nut. Tighten with precision screwdriver while securing the nut with pliers, as shown in Figure 2.

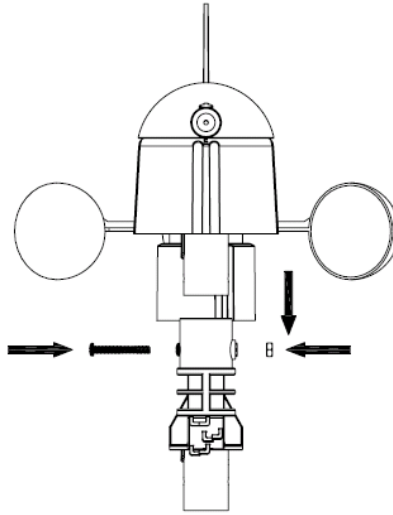

2

Figure 2

3. Connect the anemometer assembly to the top mounting pole, align the holes, and fasten with short set screw (optional) and long bolt and nut. Tighten with precision screwdriver while securing the nut with pliers, as shown in Figure 3.

 **Note:** This may be a tight fit – rotate the pole back and forth to shave off some of the plastic, and use a small hammer to tap the top of the anemometer mounting arm while securing the pole on a solid, flat surface. Use a piece of cloth or padding to dampen the hammer and avoid damage to the anemometer mounting arm.

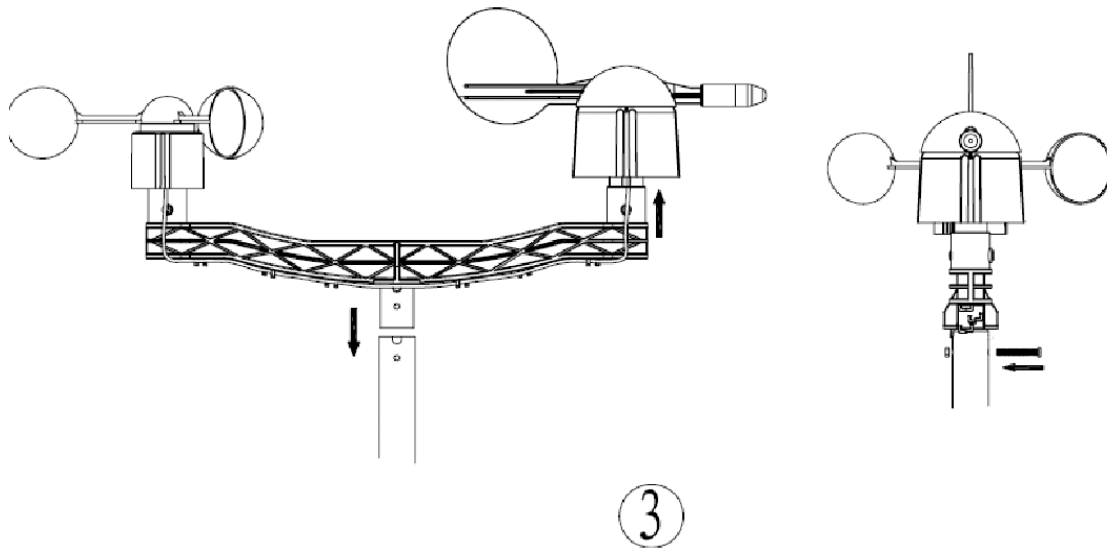



Figure 3

4. Connect the rain gauge with long set screw. Tighten with precision screwdriver, as shown in Figure 4.

 **Note:** There may be a slight “play” in the rain gauge and the screw may not be flush. Do not force the screw.

Attach the rain gauge mounting arm to the upper mounting pole, at right angles to the wind speed and wind direction assembly to avoid obstruction of rainfall.

 **Note:** There are two mounting holes on the side of the rain gauge in the event you wish to mount the rain gauge in a different location than the mounting arm

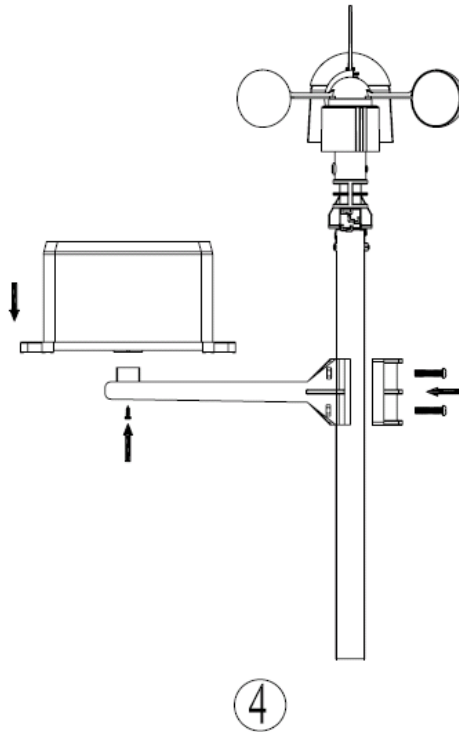

Figure 4

5. Connect the thermo-hygrometer with short bolt and nut. Tighten with precision screwdriver, as shown in Figure 5. Slide the radiation shield over the thermo-hygrometer after connecting the cables from the anemometer and rain gauge (step 7). Attach to the thermo-hygrometer mounting arm to the upper mounting pole.

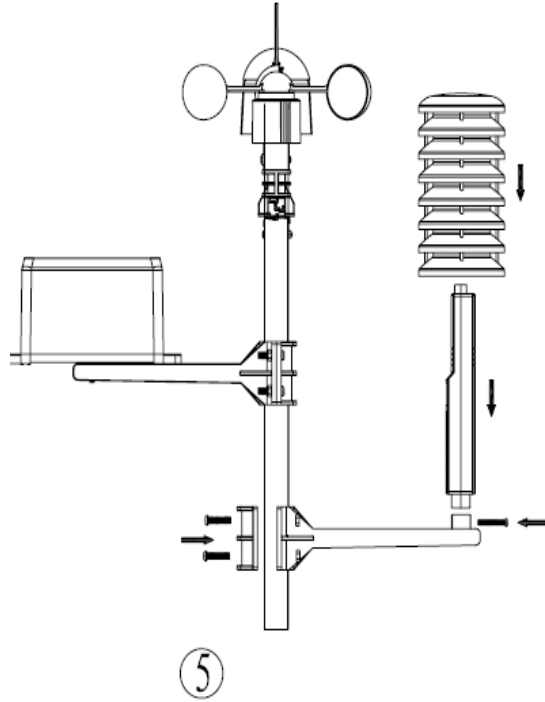

Figure 5

6. Fasten the lower mounting pole (which is swaged on the top end) to your mounting pole or bracket (purchased separately) with the hose clamps. Tighten the lower mounting pole to your mounting pole with the hose clamps with a flat head screw driver, as shown in Figure 6. Slide the top weather station pole (with the sensor array) into the lower pole (connected to your mounting pole) when your station is finally mounted.

When you install the weather station, you will need to calibrate the anemometer pointer to true north. True north can be estimated with a compass (which points to magnetic north) or a GPS, which provides true north. Wind direction is defined as the direction the wind is coming from (example, Winds from the north).

Note the four channels on the side of the wind vane. Each quadrant is labeled North, South, East and West (reference Figure 6 as an example for “E” or East). Locate the North direction (“N”) and mark it with a piece of tape for future reference. You will need this for wind direction calibration upon final assembly.

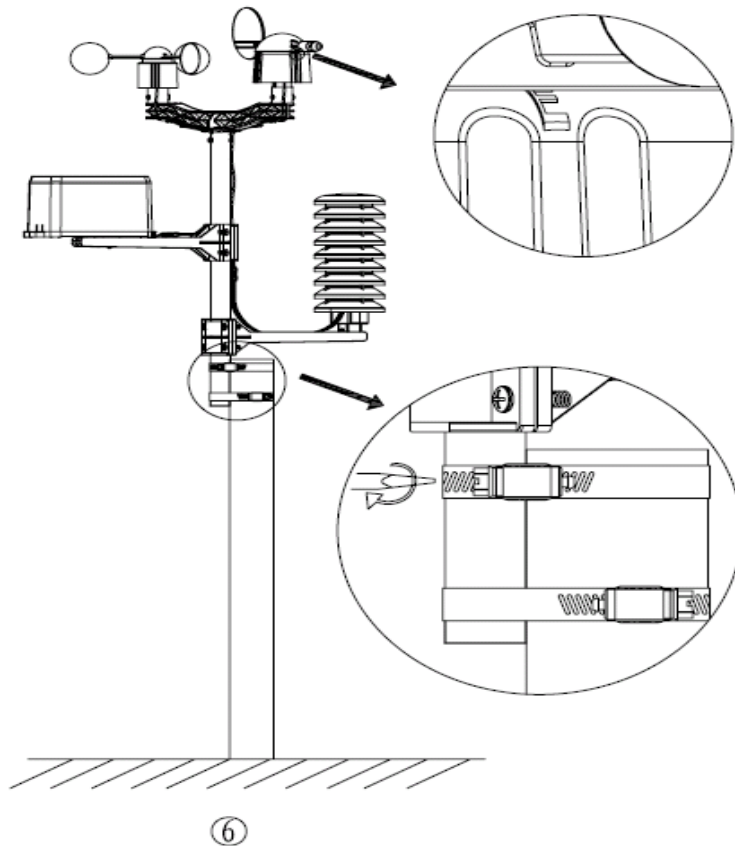



Figure 6

Connect the wind speed cable to the wind direction phone jack, as shown in Figure 8. Connect the wind direction cable to the thermo-hygrometer phone jack (reference the label on the thermo-hygrometer). Connect the rain gauge cable to the thermo-hygrometer phone jack (reference the label on the thermo-hygrometer).

Insert two AA batteries in the thermo-hygrometer, as shown in Figure 7. The transmitter LED will light up momentarily (4 seconds), and then flash once every 48 seconds for each transmission update.

 **Note:** Do not install the batteries backwards. You can permanently damage the thermo-hygrometer. Do not use rechargeable batteries.

 **Note:** We recommend installing Lithium AA batteries:

<http://www.ambientweather.com/enaaliba4pa.html>

Lithium batteries provide longer life and operate in colder temperatures.

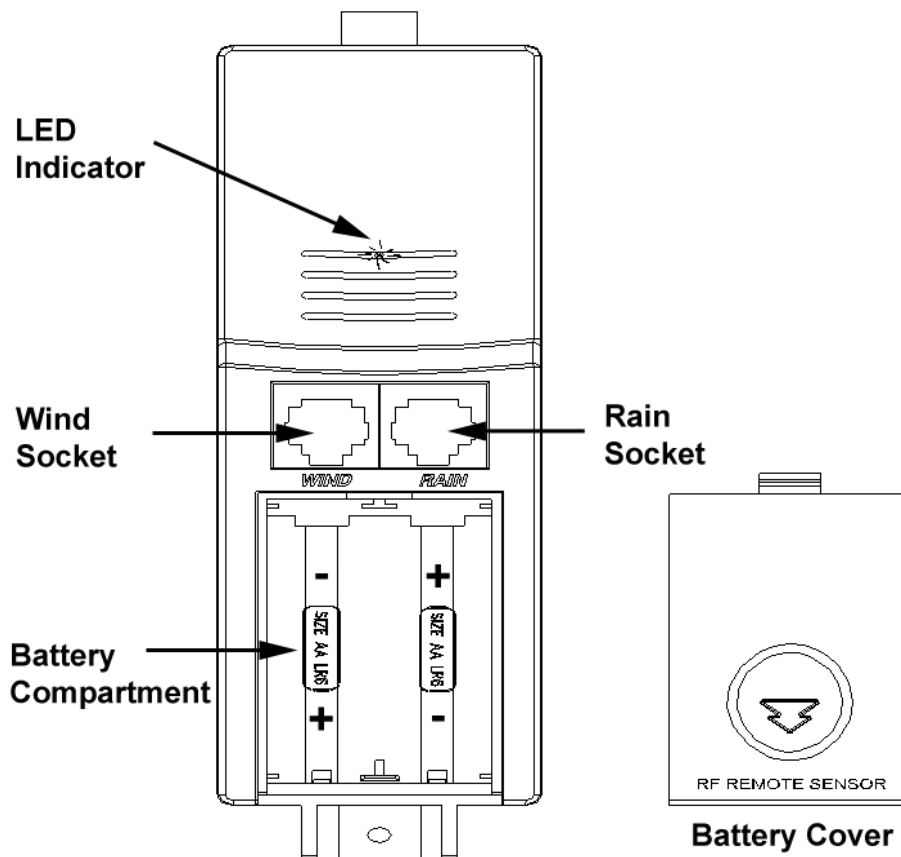

Figure 7

Install the solar shield over the thermo-hygrometer/transmitter, and use the enclosed zip ties to clean up the cables.

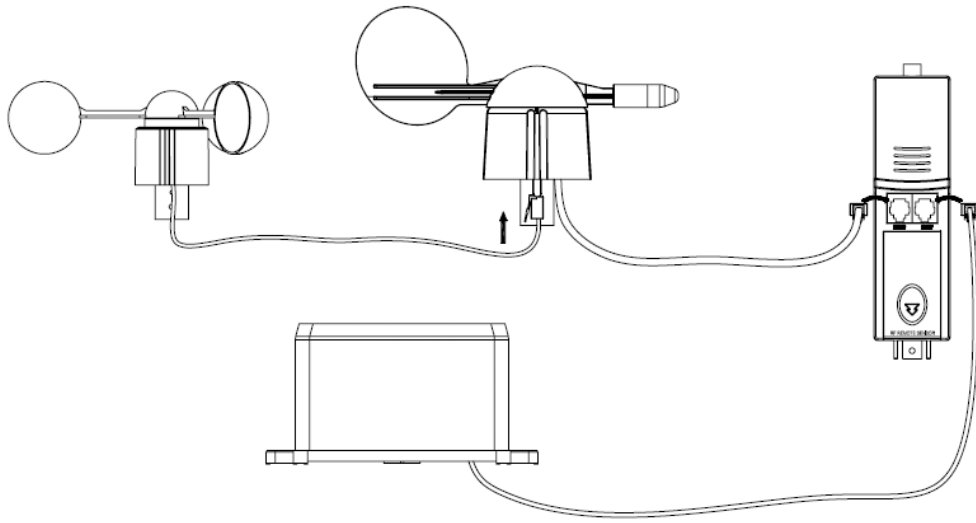



Figure 8

3.4 Display Console

3.4.1 Display Console Layout

 **Note:** All display console touch screen commands are issued by touching (not pressing) the related areas as shown in Figure 9. Pressing hard on the display console may damage the unit.

The touch screen LCD monitor is laid out as follows:

Left Top LCD:	IN-OUT temperature and humidity
Right Top LCD:	Wind and Rain measurement
Left Middle LCD:	Weather Forecast (Tendency)
Right Middle LCD:	Air Pressure and Air Pressure History
Bottom Line LCD:	Time and Date, Memory Data Usage

 **Note:** The presence of the "Alarm-On icon" in the section means that the particular alarm has been enabled.

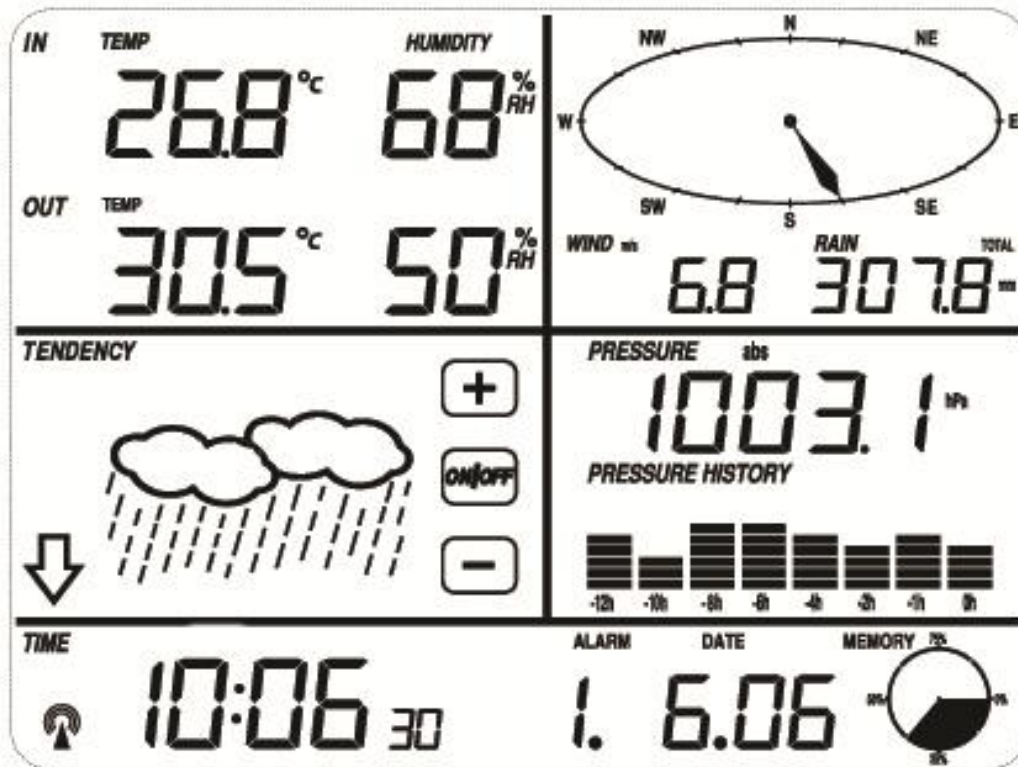



Figure 9

3.4.1 Initial Display Console Set Up

 **Note:** The sensor array must be powered and updating before powering up the console, or the console will give up searching for the sensors. Perform this step last.

Make certain the weather station sensor array is at least 10' away from the console and within 300' of the console. If the weather station is too close or too far away, it will not receive a proper signal.

Insert three AA batteries into the battery compartment on the back of the display. After inserting the batteries into the console, all of the LCD segments will light up for a few seconds to verify all segments are operating properly.

The unit will instantly display indoor temperature, humidity, barometer, tendency, date and time. The wind speed, wind direction, rain, and outdoor temperature and humidity will update on the display within a few minutes. Do not touch the LCD until the outside transmitter report in, otherwise the outdoor sensor search mode will be terminated. When the outdoor transmitter data has been received, the console will automatically switch to the normal mode from which all further settings can be performed.

If it does not update, please reference the troubleshooting guide in Section 9.

 **Note:** When making an adjustment to a parameter, touch the flashing , ON/OFF or symbols in

the tendency section of the display to increase, set or decrease values. Every time you touch the screen, the backlight will light up and a beep will sound. After 30 seconds of inactivity, the LCD will automatically revert to the normal display mode (automatic time out).

3.4.2 Sensor Operation Verification

The following steps verify proper operation of the sensors prior to installing the sensor array.

1. **Verify proper operation of the rain gauge.** Tip the sensor array back and forth several times. You should hear a “clicking” sound within the rain gauge. Verify the rain reading on the display console is not reading 0.00. Each “click” represents 0.01 inches of rainfall.
2. **Verify proper operation of the wind direction.** Align the wind vane pointer to North (as determined in Section 3.3). Verify the display reads North. Repeat for each quadrant (North, South, East, and West).
3. **Verify proper operating of the wind speed.** Rotate the wind cups manually or with a fan. Verify the wind speed is not reading 0.0.
4. **Verify proper operation of the indoor and outdoor temperature.** Verify the indoor and outdoor temperature match closely with the console and sensor array in the same location (about 10’ apart). The sensors should be within 4°F (2°C) (the accuracy is $\pm 2^\circ\text{F} / 1^\circ\text{C}$). Allow about 30 minutes for both sensors to stabilize.
5. **Verify proper operation of the indoor and outdoor humidity.** Verify the indoor and outdoor humidity match closely with the console and sensor array in the same location (about 10’ apart). The sensors should be within 8% (the accuracy is $\pm 4\%$). Allow about 30 minutes for both sensors to stabilize.

3.4.3 Radio Controlled Clock (WS-1090 only)

After the remote sensor is powered up, the sensor will transmit weather data for 30 seconds, and then the sensor will begin radio controlled clock (RCC) reception. During the RCC time reception period (maximum 10 minutes), no weather data will be transmitted to avoid interference.

If the signal reception is not successful within 1 minute, the signal search will be cancelled and will automatically resume every two hours until the signal is successfully captured. The regular RF link will resume once RCC reception routine is finished. In some locations, RCC reception may take a couple of days to receive the signal.

4. Weather Station Installation

4.1 Pre Installation Checkout

Before installing your weather station in the permanent location, we recommend operating the weather station for one week in a temporary location with easy access. This will allow you to check out all of the functions, insure proper operation, and familiarize you with the weather station and calibration procedures. This will also allow you to test the wireless range of the weather station.

4.2 Site Survey

Perform a site survey before installing the weather station. Consider the following:

1. You must clean the rain gauge once per year and change the batteries every two years. Provide easy access to the weather station.
2. Avoid radiant heat transfer from buildings and structures. In general, install the sensor array at

- least 5' from any building, structure, ground, or roof top.
3. Avoid wind and rain obstructions. The rule of thumb is to install the sensor array at least four times the distance of the height of the tallest obstruction. For example, if the building is 20' tall, install $4 \times 20' = 80'$ away. Use common sense. If the weather station is installed next to a tall building, the wind and rain will not be accurate.
 4. Wireless Range. The radio communication between receiver and transmitter in an open field can reach a distance of up to 330 feet, providing there are no interfering obstacles such as buildings, trees, vehicles, high voltage lines. Wireless signals will not penetrate metal buildings.
 5. Radio interference such as PCs, radios or TV sets can, in the worst case, entirely cut off radio communication. Please take this into consideration when choosing console or mounting locations.
 6. Visit Ambient Weather Mounting Solutions for assistance and ideas for mounting your weather station:

<http://www.ambientweather.com/amwemoso.html>

4.3 Final Installation of Sensor Array

Mount the weather station in the permanent location. To calibrate the wind direction, align the wind direction pointer with the "N" marking on the side of the wind direction sensor, as described in Section 3.3. Rotate the upper pole until the vane pointer, marking, and true north wind direction are aligned.

5. Console Operation

 **Note:** The programming procedure can be exited at any time by touching any other function area (except "+", "-", or "ON/OFF").

The following procedures are initiated by touching the Touch Screen in the desired display area.

 **Note:** You can also program the weather station console through the PC software (recommended).

5.1 Indoor Temperature

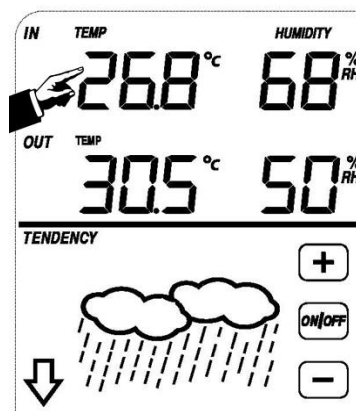













Figure 10



1. Touch the indoor temperature once, as shown in Figure 10. The indoor temperature will begin





flashing and the  button and  button will be flashing (in the tendency section of the display).

2. **Indoor Temperature Units.** Touch the  button or  button to alternate the display unit between °C and °F (press the indoor temperature again if you wish to skip this setting).
3. **Indoor Temperature High Alarm.** Touch the INDOOR TEMPERATURE section again to set the indoor temperature high alarm function. The ,  and  button will be flashing, and HI AL (high alarm) icon will light up.

Touch the  button or  button to change the value, or hold the  button or  button for 3 seconds to rapidly change the setting.

Touch the  button to select the alarm on or off (if the alarm is enabled, the speaker icon will be turned on, indicating the alarm function has been enabled).

4. **Indoor Temperature Low Alarm.** Touch the INDOOR TEMPERATURE section again to set the indoor temperature low alarm function. The ,  and  button will be flashing, and LO AL (high alarm) icon will light up.

Touch the  button or  button to change the value, or hold the  button or  button for 3 seconds to rapidly change the setting.

Touch the  button to select the alarm on or off (if the alarm is enabled, the speaker icon will be turned on, indicating the alarm function has been enabled).

5. **Indoor Temperature Record High.** Touch the INDOOR TEMPERATURE section again to display maximum indoor temperature record since the last reset. The maximum record will be flashing, and the MAX icon will light up. To reset, press the maximum temperature value for 3 seconds, and the maximum value will be reset to current reading.
6. **Indoor Temperature Record Low.** Touch the INDOOR TEMPERATURE section again to display minimum indoor temperature record since the last reset. The minimum record will be flashing, and the MIN icon will light up. To reset, press the minimum temperature value for 3 seconds, and the minimum value will be reset to current reading.

5.2 Outdoor Temperature, Wind Chill and Dew Point

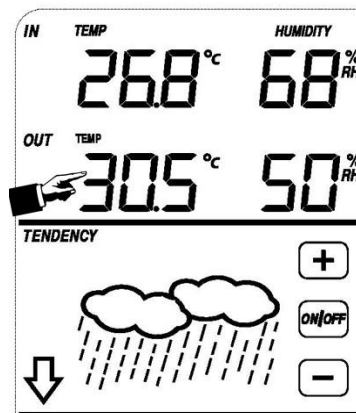







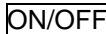















Figure 11

1. Touch the outdoor temperature once, as shown in Figure 11. The outdoor temperature will begin flashing and the  button and  button will be flashing (in the tendency section of the display).
2. **Outdoor Temperature, Wind chill and Dew Point.** Touch the  button or  button to alternate the display between the outdoor temperature, wind chill and dew point.
3. **Outdoor Temperature Units.** Touch the  button or  button to alternate the display unit between °C and °F (press the outdoor temperature again if you wish to skip this setting).
4. **Outdoor Temperature High Alarm.** Touch the OUTDOOR TEMPERATURE section again to set the outdoor temperature high alarm function. The ,  and  button will be flashing, and HI AL (high alarm) icon will light up.

Touch the  button or  button to change the value, or hold the  button or  button for 3 seconds to rapidly change the setting.

Touch the  button to select the alarm on or off (if the alarm is enabled, the speaker icon will be turned on, indicating the alarm function has been enabled).

5. **Outdoor Temperature Low Alarm.** Touch the OUTDOOR TEMPERATURE section again to set the outdoor temperature low alarm function. The ,  and  button will be flashing, and LO AL (high alarm) icon will light up.

Touch the  button or  button to change the value, or hold the  button or  button for 3 seconds to rapidly change the setting.

Touch the  button to select the alarm on or off (if the alarm is enabled, the speaker icon will be turned on, indicating the alarm function has been enabled).

6. **Outdoor Temperature Record High.** Touch the OUTDOOR TEMPERATURE section again to display maximum outdoor temperature record since the last reset. The maximum record will be flashing, and the MAX icon will light up. To reset, press the maximum temperature value for 3 seconds, and the maximum value will be reset to current reading.
7. **Outdoor Temperature Record Low.** Touch the OUTDOOR TEMPERATURE section again to display minimum outdoor temperature record since the last reset. The minimum record will be flashing, and the MIN icon will light up. To reset, press the minimum temperature value for 3 seconds, and the minimum value will be reset to current reading.

8. Repeat the above steps for wind chill and dew point.

5.3 Indoor Humidity

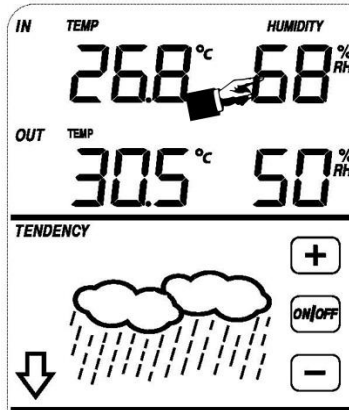

Figure 12

1. Touch the indoor humidity once, as shown in Figure 12. The indoor humidity will begin flashing and the **+** button and **-** button will be flashing (in the tendency section of the display).
2. **Indoor Humidity High Alarm.** Touch the INDOOR HUMIDITY section again to set the indoor humidity high alarm function. The **+**, **ON/OFF** and **-** button will be flashing, and **HI AL** (high alarm) icon will light up.

Touch the **+** button or **-** button to change the value, or hold the **+** button or **-** button for 3 seconds to rapidly change the setting.

Touch the **ON/OFF** button to select the alarm on or off (if the alarm is enabled, the speaker icon will be turned on, indicating the alarm function has been enabled).

3. **Indoor Humidity Low Alarm.** Touch the INDOOR HUMIDITY section again to set the indoor humidity low alarm function. The **+**, **ON/OFF** and **-** button will be flashing, and **LO AL** (low alarm) icon will light up.

Touch the **+** button or **-** button to change the value, or hold the **+** button or **-** button for 3 seconds to rapidly change the setting.

Touch the **ON/OFF** button to select the alarm on or off (if the alarm is enabled, the speaker icon will be turned on, indicating the alarm function has been enabled).

4. **Indoor Humidity Record High.** Touch the INDOOR HUMIDITY section again to display maximum indoor humidity record since the last reset. The maximum record will be flashing, and the **MAX** icon will light up. To reset, press the maximum temperature value for 3 seconds, and the maximum value will be reset to current reading.
5. **Indoor Humidity Record Low.** Touch the INDOOR HUMIDITY section again to display minimum indoor humidity record since the last reset. The minimum record will be flashing, and the **MIN** icon will light up. To reset, press the minimum temperature value for 3 seconds, and the minimum value will be reset to current reading.

5.4 Outdoor Humidity

Please reference Section 5.3. The outdoor procedure is similar to the indoor humidity procedure.

5.5 Wind Speed

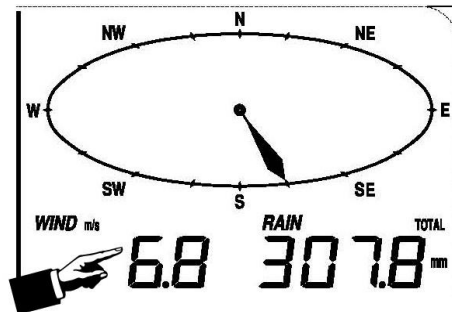

Figure 13

1. Touch the wind speed once, as shown in Figure 11. The wind speed will begin flashing and the button and button will be flashing (in the tendency section of the display).
2. **Average Wind Speed and Wind Gust.** Touch the button or button to alternate the display between the 48 second Wind Average Speed and Gust Speed (and the maximum wind speed in the update period, which is 48 seconds).
3. **Wind Speed Units.** Touch the WINDSPEED again to set the wind speed units, and the button or button to alternate the display unit between km/h, mph, m/s, knots, and bft (or Beaufort scale) (press the wind speed again if you wish to skip this setting).
4. **Wind Speed High Alarm.** Touch the WIND SPEED section again to set the wind speed high alarm function. The , and button will be flashing, and **HI AL** (high alarm) icon will light up.

Touch the button or button to change the value, or hold the button or button for 3 seconds to rapidly change the setting.

Touch the button to select the alarm on or off (if the alarm is enabled, the speaker icon will be turned on, indicating the alarm function has been enabled).

5. **Wind Direction Alarm.** Touch the WIND SPEED section again to set the wind direction alarm function. The , and button will be flashing, and the wind direction arrow will start to flashing.

Touch the button or button to change the value.

Touch the button to select the alarm on or off (if the alarm is enabled, the speaker icon will be turned on, indicating the alarm function has been enabled).

6. **Wind Speed Record High.** Touch the WIND SPEED section again to display maximum wind speed record since the last reset. The maximum record will be flashing, and the **MAX** icon will light up. To reset, press the wind speed value for 3 seconds, and the maximum value will be reset to current reading.

5.6 Rain

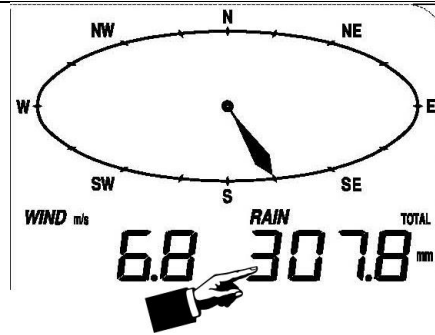

















Figure 14

1. Touch the rain once, as shown in Figure 14. The rain will begin flashing and the  button and  button will be flashing (in the tendency section of the display).
2. **Rain Increment.** Touch the  button or  button to alternate the display unit between 1 hour, 24 hour, week, month and total rain (press the rain again if you wish to skip this setting).
3. **Rain Units.** Touch the  button or  button to alternate the display unit between mm and inch (press the rain again if you wish to skip this setting).
4. **Rain High Alarm.** Touch the RAIN section again to set the rain high alarm function. The ,  and  button will be flashing, and HI AL (high alarm) icon will light up.
 Touch the  button or  button to change the value, or hold the  button or  button for 3 seconds to rapidly change the setting.
 Touch the  button to select the alarm on or off (if the alarm is enabled, the speaker icon will be turned on, indicating the alarm function has been enabled).
5. **Rain Record High.** Touch the RAIN section again to display maximum outdoor rain record since the last reset. The maximum record will be flashing, and the MAX icon will light up. To reset, press the maximum rain value for 3 seconds, and the maximum value will be reset to current reading.
6. **Reset Rain.** Touch the RAIN section again to reset the rain values. To reset, press the rain value for 3 seconds and the 1 hour, 24 hour, week, month and total rain will reset to 0.

5.7 Weather Forecast (Tendency)

 **Note:** The weather forecast or pressure tendency is based in the rate of change of barometric pressure. In general, when the pressure increases, the weather improves (sunny to partly cloudy) and when the pressure decreases, the weather degrades (cloudy to rain).

The weather forecast is an estimation or generalization of weather changes in the next 24 to 48 hours, and varies from location to location. The tendency is simply a tool for projecting weather conditions and is never to be relied upon as an accurate method to predict the weather.

TENDENCY

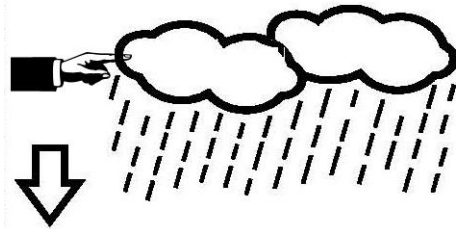















Figure 15

1. Touch the tendency once, as shown in Figure 15. The tendency will begin flashing and the  button and  button will be flashing (in the tendency section of the display).
2. **Change Tendency.** Select the  button or  button to alternate the display unit between SUNNY, PARTLY CLOUDY and CLOUDY, and RAINY (press the tendency again if you wish to skip this setting).
3. **Pressure Threshold.** Touch the TENDENCY section again, and the  button and  button will be flashing. Touch the  button or  button to adjust the pressure threshold from 2.0 to 4.0 hPa/hr (the default is 2 hPa/hr).
4. **Storm Threshold.** Touch the TENDENCY section again, and the  button and  button will be flashing. Touch the  button or  button to adjust the storm threshold from 3.0 to 9.0 hPa/hr (the default is 4 hPa/hr).

5.8 Barometric Pressure

 **Note:** The weather station console displays two different pressures: absolute (measured) and relative (corrected to sea-level).

To compare pressure conditions from one location to another, meteorologists correct pressure to sea-level conditions. Because the air pressure decreases as you rise in altitude, the sea-level corrected pressure (the pressure your location would be at if located at sea-level) is generally higher than your measured pressure.

Thus, your absolute pressure may read 28.62 inHg (969 mb) at an altitude of 1000 feet (305 m), but the relative pressure is 30.00 inHg (1016 mb).

The standard sea-level pressure is 29.92 in Hg (1013 mb). This is the average sea-level pressure around the world. Relative pressure measurements greater than 29.92 inHg (1013 mb) are considered high pressure and relative pressure measurements less than 29.92 inHg are considered low pressure.

To determine the relative pressure for your location, locate an official reporting station near you (the internet is best source for real time barometer conditions, such as Weather.com or Wunderground.com), and set your weather station to match the official reporting station.

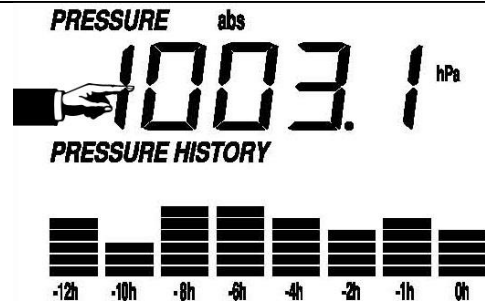























Figure 16



1. Touch the **PRESSURE** once, as shown in Figure 16. The barometric pressure will begin flashing and the  button and  button will be flashing (in the tendency section of the display).
2. **Relative vs. Absolute Pressure Display.** Touch the  button or  button to alternate the display unit between relative pressure and absolute pressure (press the **PRESSURE** again if you wish to skip this setting).
3. **Pressure Units.** Touch the **PRESSURE** section again to change the pressure units. Touch the  button or  button to alternate the display unit between hPa, inHg and mmHg.
4. **Relative Pressure Calibration.** Touch the **PRESSURE** section again to change the relative pressure. The ,  and  button will be flashing, and **rel** (relative pressure) icon will flash.





Touch the  button or  button to change the value, or hold the  button or  button for 3 seconds to rapidly change the setting.

5. **Pressure Rate of Change High Alarm.** Touch the **PRESSURE** section again to set the pressure rate of change (per hour) high alarm function. The ,  and  button will be flashing, and **HI AL** (high alarm) icon will light up.

Touch the  button or  button to change the value, or hold the  button or  button for 3 seconds to rapidly change the setting.

Touch the  button to select the alarm on or off (if the alarm is enabled, the speaker icon will be turned on, indicating the alarm function has been enabled).

6. **Pressure Rate of Change Low Alarm.** Touch the **PRESSURE** section again to set the pressure rate of change (per hour) low alarm function. The ,  and  button will be flashing, and **LO AL** (low alarm) icon will light up.

Press the  button or  button to change the value, or hold the  button or  button for 3 seconds to rapidly change the setting.

Press the  button to select the alarm on or off (if the alarm is enabled, the speaker icon will be turned on, indicating the alarm function has been enabled).



7. **Pressure Record High.** Touch the **PRESSURE** section again to display maximum pressure record since the last reset. The maximum record will be flashing, and the **MAX** icon will light up. To reset, press the maximum pressure value for 3 seconds, and the maximum value will be reset to current reading.



- Pressure Record Low.** Touch the PRESSURE section again to display minimum pressure record since the last reset. The minimum record will be flashing, and the MIN icon will light up. To reset, press the pressure value for 3 seconds, and the minimum value will be reset to current reading.

Note: when absolute pressure is selected, step 4 will be skipped.

5.9 Pressure Graph

 **Note:** The weather station bar graph flashes from left to right to prevent screen burn in. This feature cannot be turned off.



Touch the PRESSURE GRAPH once, as shown in Figure 16. The barometric pressure will begin flashing and the  button and  button will be flashing (in the tendency section of the display).



Press the  button or  button to change the pressure history time axis between 12 hours and 24 hours.



5.10 Time





Figure 17

- Display Contrast Level.** Touch the TIME once, as shown in Figure 17. The display contrast value will begin flashing (example, lcd0 thru lcd8), and the  button and  button will be flashing (in the tendency section of the display).

Press the  button or  button to adjust the contrast level from 0 to 8. (the default is 5).

- Time Zone.** Touch the TIME button again to display the time zone. The time zone value will begin flashing and the  button and  button will be flashing (in the tendency section of the display).

Press the  button or  button to adjust the time zone from -12 to 12, based on the number of hours from Coordinated Universal Time, or Greenwich Mean Time (GMT).

The following table provides times zones throughout the world. Locations in the eastern hemisphere are positive, and locations in the western hemisphere are negative.

Hours from GMT	Time Zone	Cities
-12	IDLW: International Date Line West	---
-11	NT: Nome	Nome, AK
-10	AHST: Alaska-Hawaii Standard CAT: Central Alaska HST: Hawaii Standard	Honolulu, HI
-9	YST: Yukon Standard	Yukon Territory

-8	PST: Pacific Standard	Los Angeles, CA, USA
-7	MST: Mountain Standard	Denver, CO, USA
-6	CST: Central Standard	Chicago, IL, USA
-5	EST: Eastern Standard	New York, NY, USA
-4	AST: Atlantic Standard	Caracas
-3	---	São Paulo, Brazil
-2	AT: Azores	Azores, Cape Verde Islands
-1	WAT: West Africa	---
0	GMT: Greenwich Mean WET: Western European	London, England
1	CET: Central European	Paris, France
2	EET: Eastern European	Athens, Greece
3	BT: Baghdad	Moscow, Russia
4	---	Abu Dhabi, UAE
5	---	Tashkent
6	---	Astana
7	---	Bangkok
8	CCT: China Coast	Beijing
9	JST: Japan Standard	Tokyo
10	GST: Guam Standard	Sydney
11	---	Magadan
12	IDLE: International Date Line East NZST: New Zealand Standard	Wellington, New Zealand

- 12/24 Hour Format.** Touch the TIME section again to change the 12/24 hour format. Touch the button or button to alternate the display unit between 12 hour format and 24 hour format.
- Daylight Saving Time.** Touch the TIME section again to turn ON and OFF daylight savings time observance (example, Arizona and parts of Indiana do not observe daylight savings time). Touch the button or button to alternate the display unit between ON and OFF.
- Change Hour.** Touch the TIME section again to set the hour. Touch the button or button to change the hour setting.
- Change Minute.** Touch the TIME section again to set the minute. Touch the button or button to change the minute setting.



5.11 Date







Figure 18



- Alarm Time, Date and Date of the Week.** Touch the TIME once, as shown in Figure 18. The date and time will begin flashing and the button and button will be flashing (in the





tendency section of the display).



Press the  button or  button to adjust the alternate the display between the alarm time, and date and week date.





2. **Date Format.** Touch the DATE button again to display the date format (Md for month/day or Dm for Day/Month). The date value will begin flashing and the  button and  button will be flashing (in the tendency section of the display).



Press the  button or  button to adjust the alternate the display between the DD-MM format and MM-DD format for the date.





3. **Change Year.** Touch the DATE section again to set the year. Touch the  button or  button to change the year setting. The year will begin flashing.



Press the  button or  button to change the value, or hold the  button or  button for 3 seconds to rapidly change the setting.





4. **Change Month.** Touch the DATE section again to set the month. Touch the  button or  button to change the year setting. The month will begin flashing.



Press the  button or  button to change the value, or hold the  button or  button for 3 seconds to rapidly change the setting.





5. **Change Day.** Touch the DATE section again to set the day. Touch the  button or  button to change the year setting. The day will begin flashing.

Press the  button or  button to change the value, or hold the  button or  button for 3 seconds to rapidly change the setting.

6. **Change Alarm Hour.** Touch the DATE section again to set the alarm hour. Touch the  button or  button to change the alarm hour setting. The alarm hour will begin flashing.

Press the  button or  button to change the value, or hold the  button or  button for 3 seconds to rapidly change the setting.

7. **Change Alarm Minute.** Touch the DATE section again to set the alarm minute. Touch the  button or  button to change the alarm minute setting. The alarm hour will begin flashing.

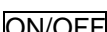

Press the  button or  button to change the value, or hold the  button or  button for 3 seconds to rapidly change the setting.



Touch the  button to select the alarm on or off (if the alarm is enabled, the speaker icon will be turned on, indicating the alarm function has been enabled).

5.12 Memory

For a comprehensive weather history, the console stores up to 4080 complete sets of weather data with time and date stamp. The base station will lose all of the weather data if there a power interruption. In the event the memory is full, the old data is overwritten by the new data.

1. **Review Historical Archived Data.** Touch the MEMORY section once (next to the date

section) to review memory or historical archived data. The  button and  button will be flashing (in the tendency section of the display).

Select the  button to review historical data archived in the console. Select the  button to advance historical data archived in the console (default is 30 minute intervals).

When history data displayed, the corresponding date and time will be displayed at the time section area.

The historical archive interval can only be changed using the PC software that comes with this product. The factory default archive interval is 30 minutes.

2. **Clear Memory.** Touch the MEMORY section again to clear memory. The word “CLEAR” will be displayed and the memory fill icon will be flashing. Press and hold the memory full icon for 3 seconds to clear memory.

6. PC Software

 **Note:** EasyWeather software is included with this weather station package. Easy Weather runs on most PC operating systems. Cumulus is free internet publishing PC software application by Sandaysoft. WeatherSnoop is a paid software and internet publishing application for Macs by Tee-Boy.

For EasyWeather updates and alternate PC applications, visit:

<http://ambientweather.wikispaces.com/ws1080>

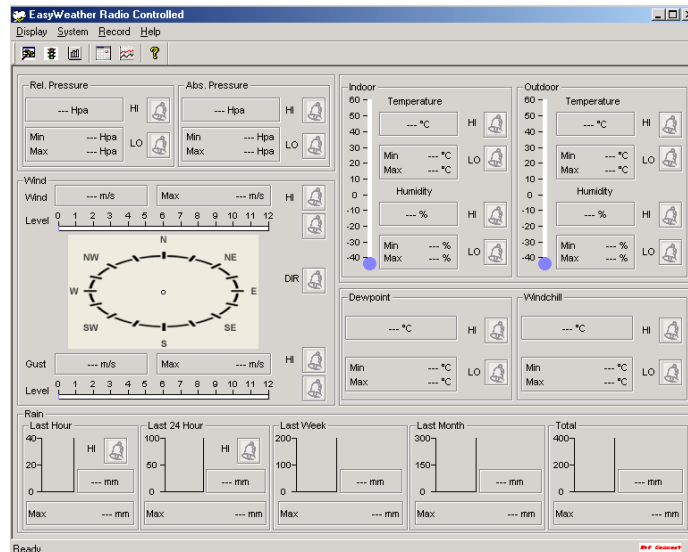

Figure 19

6.1 EasyWeather Overview

EasyWeather allows you to display real-time data, program the display console, set alarms, view and

export historical data and create graphs. Whereas the weather station console is limited to 4080 records, EasyWeather is only limited by your PC's memory.

6.2 Connect PC Connection

Connect the weather station console to the PC using the included USB cable. The computer should acknowledge the connection with a beep and the device installation notice will be displayed if connected for the first time.

6.3 EasyWeather Software Installation

Insert the included CD into your hard drive and the software installer will automatically start. If it does not, browse to My Computer (or Computer) in windows and locate the CD Drive. Right click on this drive, select **Explore** and run **Setup.exe**.

The software will install to the program files directory.

6.4 Run EasyWeather

To run EasyWeather, in Windows, select Start -> **All Programs** -> **Easy Weather**.

 **Note:** You may be prompted to run EasyWeather as the administrator (Vista and Windows7). To perform this action, browse to the program files directory location using Windows explorer, commonly located here:

C:\Program Files\EasyWeather

Right Click on the **EasyWeather.exe** icon, select the **Compatibility** Tab and under **Privilege Level**, select **Run as Administrator**.

Failure to run the program as administrator may limit the graphical display mode capability, since EasyWeather writes data to file locations deemed protected with strict Microsoft protection enabled.

 **Note:** If you run the program for the first time, the current weather will be displayed and at the bottom line of the window, and the program will show related information regarding reading historical data into the PC.

When there is large amount of archived data to be uploaded, it may take a few minutes before the system will respond to your requests. Otherwise, it will display the "read weather data fail" error message, since the USB port is reading the data from the memory and the system is not able to respond to requests.

6.5 EasyWeather Features

The following section outlines the features available in the EasyWeather Software.

6.5.1 Main Display

When you launch EasyWeather, the main display will be shown. The main display shows current weather conditions, alarm settings and minimum and maximum data.

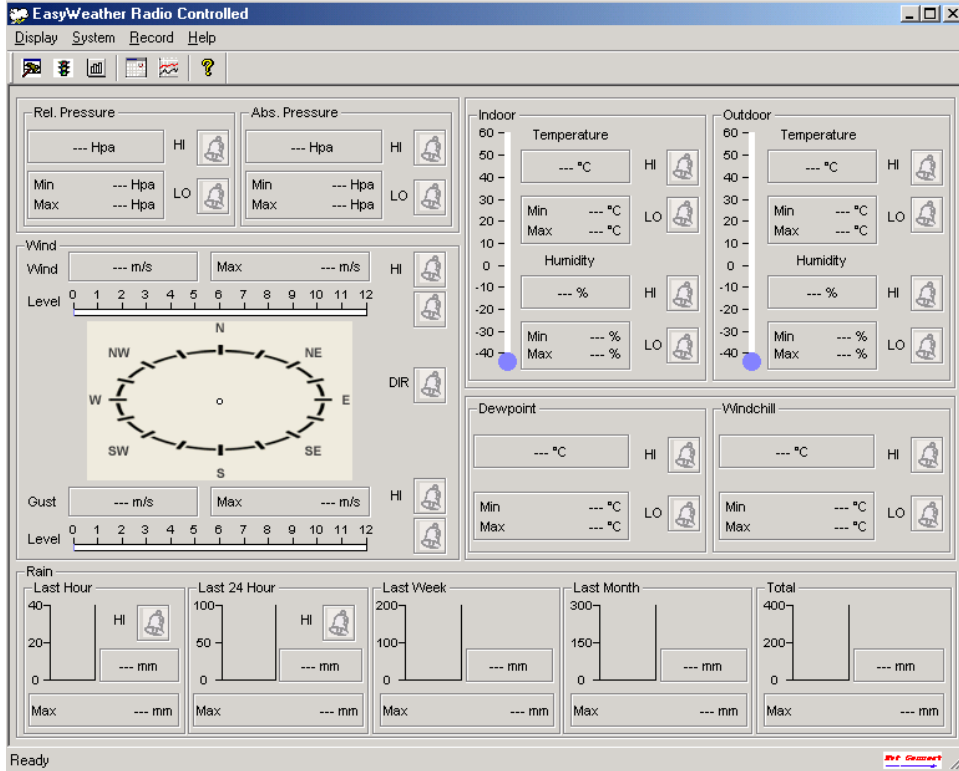



Figure 20

When console is connected to PC, the connected icon  will be displayed on the main display panel. If the console is not connected, the not connected icon  will be displayed.

6.5.2 Set-up and Alarms

Select **System | Setup** from the menu bar to program general weather station console settings and turn on and off alarm conditions, or select the  icon.

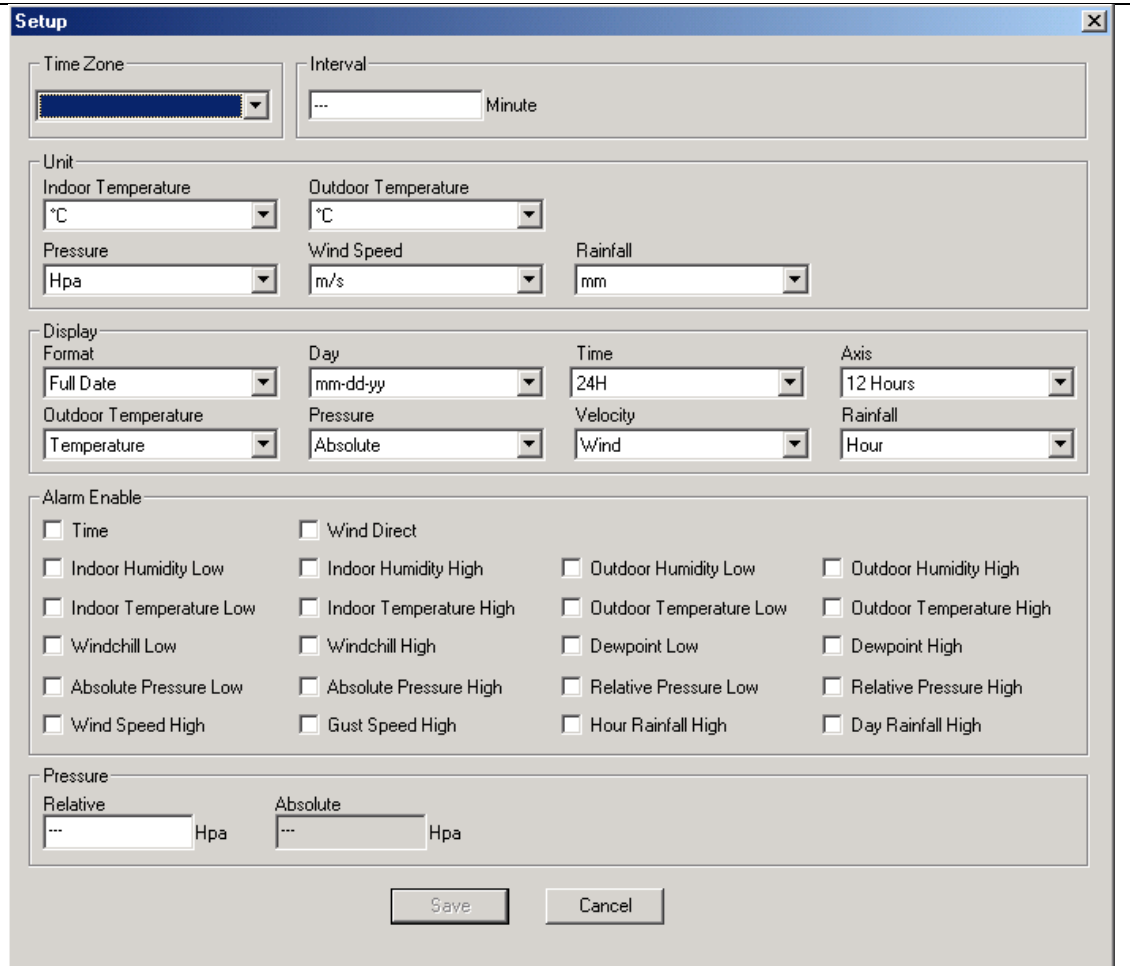



Figure 21

6.5.3 Alarm Values

Select **System | Alarm** from the menu bar to program general to set the alarm ranges, or select the  icon.

Alarm
✕

Time
 Hour: Minute:

Indoor Humidity
 High: % Low: %

Outdoor Humidity
 High: % Low: %

Indoor Temperature
 High: °C Low: °C

Outdoor Temperature
 High: °C Low: °C

Windchill
 High: °C Low: °C

Dewpoint
 High: °C Low: °C

Absolute Pressure
 High: inHg Low: inHg

Relative Pressure
 High: inHg Low: inHg

Wind
 High: km/h bft

Gust
 High: km/h bft

Rain
 High Hour: mm High 24 Hour: mm

Wind Direct

Figure 22

6.5.4 Historical Highs and Lows

Select **System | Scope** from the menu bar to view the historical highs and lows, or select the  icon.

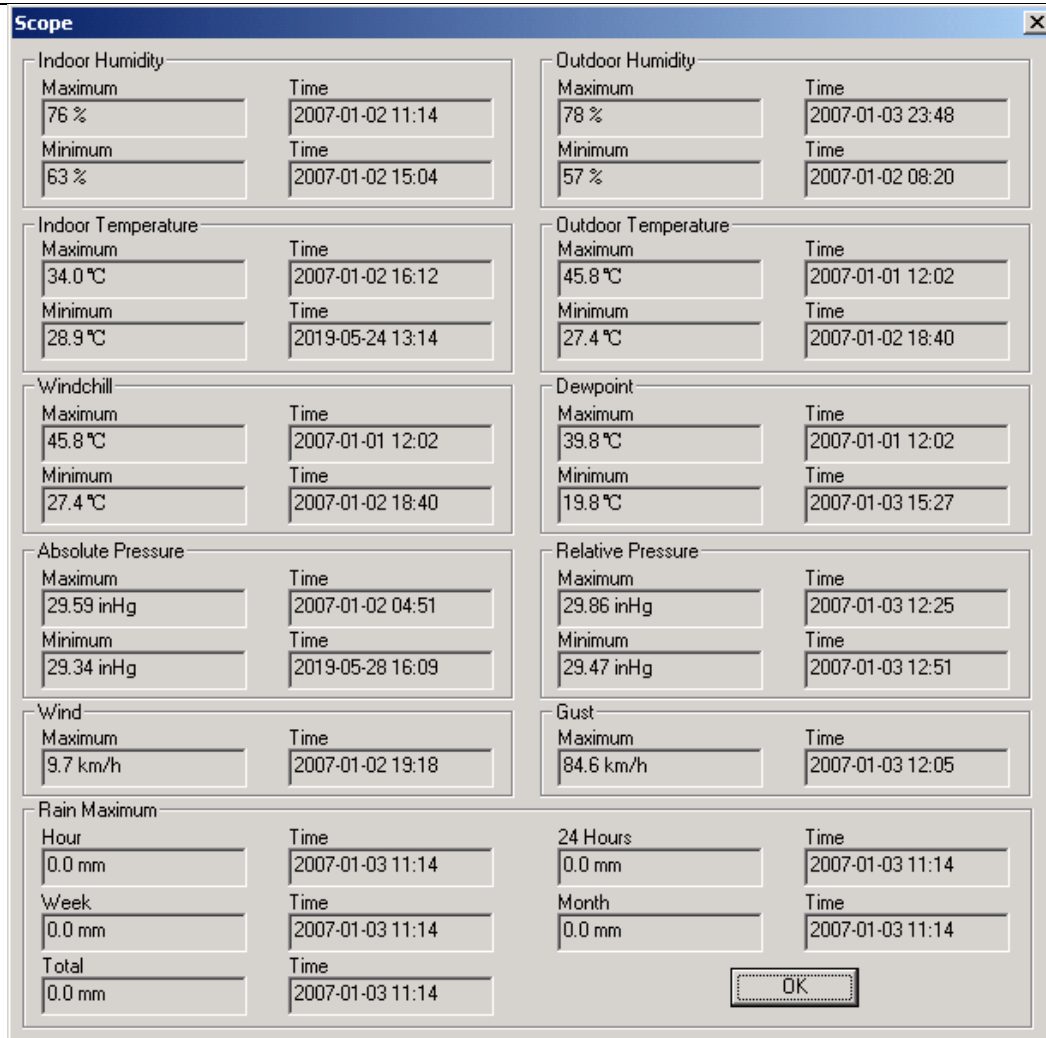

Figure 23

6.5.5 Historical Data

Select **Record | History** from the menu bar to view the historical data, or select the



icon.

This window displays the recorded history data in a spread sheet format. If you want to see all history data in a specified time period, enter the time duration and press **Search** to reload the historical data.

You can export the selected historical data into a text format file by selecting the **Export** button.

When memory on the console is full, select the **Clear Memory** button to clear memory on the console (remember to upload all of the data before pressing this button).

If you want to start a new weather history record, select the **Clear Data** button to clear the database, and all historical weather data will be deleted (if you would like to keep a back up history file before

deleting all weather data, you can make a copy of the “EasyWeather.dat” file into another folder or just rename the “EasyWeather.dat” file, such as “Jan-07.dat”, for future reference.

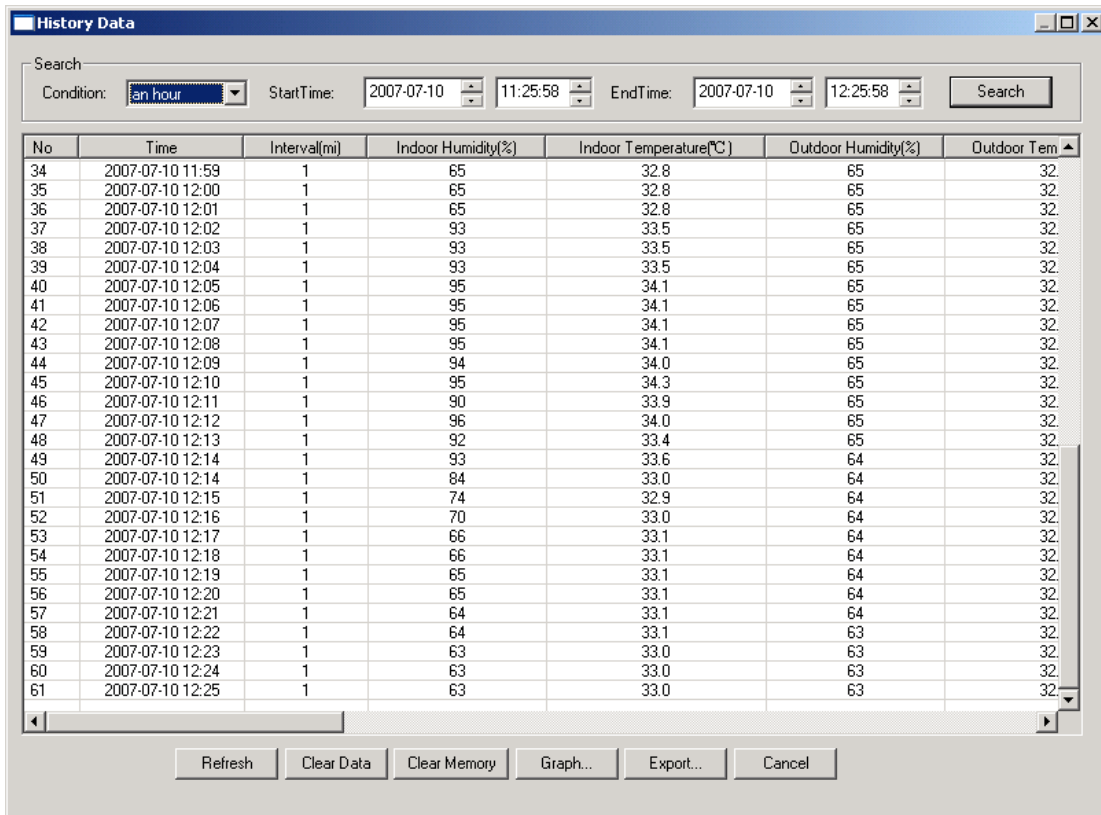

Figure 24

6.5.6 Graph Data

Select **Record | Graph** from the menu bar to view the graphical data, or select the

 icon.



Figure 25

6.5.7 EasyWeather Legal Notes

- We reserve the right to delete or change any image whether or not purposely uploaded onto the server by a user of the EasyWeather software products.
- The EasyWeather software products are protected by copyright laws and international copyright treaties as well as other intellectual property laws and treaties.
- You may not copy the printed materials accompanying the products.

7. Glossary of Terms

Term	Definition
Absolute Barometric Pressure	Relative barometric pressure, corrected to sea-level. To compare pressure conditions from one location to another, meteorologists correct pressure to sea-level conditions. Because the air pressure decreases as you rise in altitude, the sea-level corrected pressure (the pressure your location would be at if located at sea-level) is generally higher than your measured pressure.
Accuracy	Accuracy is defined as the ability of a measurement to match the actual value of the quantity being measured.
HectoPascals (hPa)	Pressure units in SI (international system) units of measurement. Same as millibars (1 hPa = 1 mbar)
Hygrometer	A hygrometer is a device that measures relative humidity. Relative humidity is a term used to describe the amount or percentage of water vapor that exists in air.
Inches of Mercury (inHg)	Pressure in Imperial units of measure.

Term	Definition
	1 inch of mercury = 33.86 millibars
Range	Range is defined as the amount or extent a value can be measured.
Relative Barometric Pressure	Measured barometric pressure relative to your location or ambient conditions.
Resolution	Resolution is defined as the number of significant digits (decimal places) to which a value is being reliably measured.
Wind Vane	A wind vane is a device that measures the direction of the wind. The wind vane is usually combined with the anemometer. Wind direction is the direction from which the wind is blowing.

8. Specifications

8.1 Wireless Specifications

- Line of sight wireless transmission (in open air): 300 feet
- Update Rate: 48 seconds
- Frequency
 - WS-1080: 433 MHz
 - WS-1090: 916 MHz

8.2 Measurement Specifications

The following table provides the specifications for the measured parameters.

Measurement	Range	Accuracy	Resolution
Indoor Temperature	32 to 140 °F	± 2 °F	0.1 °F
Outdoor Temperature	-40 to 149 °F	± 2 °F	0.1 °F
Indoor Humidity	10 to 99 %	± 4%	1 %
Outdoor Humidity	10 to 99%	± 4%	1 %
Barometric Pressure	8.85 to 32.50 inHg	± 0.08 inHg (within range of 27.13 to 32.50 inHg)	0.01 inHg
Rain	0 to 394 in.	± 10%	0.01 in
Wind Direction	0 - 360 °	22.5° (16 point compass)	22.5° (16 point compass)
Wind Speed	0 to 112 mph	± 2.2 mph or 10% (whichever is greater)	0.1 mph

8.3 Power Consumption

- Base station : 3XAA 1.5V LR6 Alkaline batteries
- Remote sensor : 2xAA 1.5V LR6 Alkaline batteries
- Battery life: Minimum 12 months for base station
Minimum 24 months for thermo-hygro sensor (use lithium batteries in cold weather climates)

8.4 Cable Lengths

- Anemometer to Thermo-Hygrometer-Transmitter: 8.5 feet

- Rain Gauge to Thermo-Hygrometer-Transmitter: 8.5 feet

9. Maintenance

1. Clean the rain gauge once every 3 months
2. Replace the thermo-hygrometer transmitter batteries once every 1-2 years
3. Clean the wind vane and thermo-hygrometer transmitter connectors with rubbing alcohol and q-tip once every 1-2 years.

10. Troubleshooting Guide

If your question is not answered here, you can contact us as follows:









1. Email Support: support@ambientweather.com
2. Live Chat Support: www.ambientweather.com/chat.html (M-F 8am to 4pm Arizona Time)
3. Technical Support: 480-283-1644 (M-F 8am to 4pm Arizona Time)

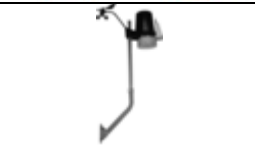

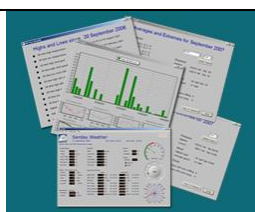

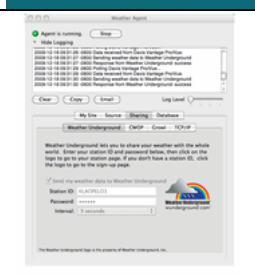
Problem	Solution
<p>Wireless remote (thermo-hygrometer) not reporting in to console.</p> <p>There are dashes on the display console.</p>	<p>The maximum line of sight communication range is 300'. Move the sensor assembly closer to the display console.</p> <p>If the sensor assembly is too close (less than 10'), move the sensor assembly away from the display console.</p> <p>Cycle power on the console. The console may have exited the search mode.</p> <p>Install a fresh set of batteries in the remote thermo-hygrometer. For cold weather environments, install lithium batteries.</p> <p>Make sure the remote sensors are not transmitting through solid metal (acts as an RF shield), or earth barrier (down a hill).</p> <p>Move the display console around electrical noise generating devices, such as computers, TVs and other wireless transmitters or receivers.</p> <p>Move the remote sensor to a higher location.</p> <p>Radio Frequency (RF) Sensors cannot transmit through metal barriers (example, aluminum siding) or multiple, thick walls.</p>
<p>Temperature sensor reads too high in the day time.</p>	<p>In hot weather climates, the rain guard and solar shield may not be effective enough. Consider the following radiation shield: http://www.ambientweather.com/amwesrpatcan.html</p>
<p>Indoor and Outdoor Temperature do not</p>	<p>Allow up to one hour for the sensors to stabilize due to</p>

agree	signal filtering. The indoor and outdoor temperature sensors should agree within 4 °F (the sensor accuracy is ± 2 °F)
Indoor and Outdoor Humidity do not agree	Allow up to one hour for the sensors to stabilize due to signal filtering. The indoor and outdoor humidity sensors should agree within 10 % (the sensor accuracy is ± 5 %)
Humidity is reading dashes (--)	The humidity sensor is out of range (10 to 99 %)
Absolute pressure does not agree with official reporting station	<p>You may be viewing the relative pressure, not the absolute pressure.</p> <p>Select the absolute pressure. Make sure you properly calibrate the sensor to an official local weather station. Reference Section 5.8 for details.</p> <p>The barometer is only accurate to ± 0.08 inHg within the following relative pressure range: 27.13 to 32.50 inHg, which corresponds to an altitude of -2,200 to 2,700 feet. <u>At higher altitudes, expect some non-linearity or error.</u></p>
Rain gauge reports rain when it is not raining	An unstable mounting solution (sway in the mounting pole) may result in the tipping bucket incorrectly incrementing rainfall. Make sure you have a stable mounting solution. Move the rain gauge from the pole mount to a flat, stable mount (fixed, flat structure).
Touch screen is not responding	Use your thumbs to activate the touch screen as opposed to your other fingers. Your thumbs have a larger surface area.
Software does not recognize weather station	Make sure the USB cable is plugged in and recognized by the PC operating system. If it is not recognized, try a different USB connection. Avoid USB hubs.
Barometer graph flashes. Can I turn this off?	No, this feature prevents burn in of the display monitor.
Wind speed appears low	Average wind speed may have the appearance of low wind. Try switching the display to wind gust.
Display console is difficult to read	<p>Change the display contrast level as described in Section 5.10.</p> <p>Replace the batteries in the console with a fresh set of batteries.</p>
Can the lamp be turned on all of time?	No, to prevent the bulb from burning out, it can only turn on temporarily.
The forecast icon is not accurate	<p>The weather station console must run for several days to trend barometric pressure.</p> <p>The weather forecast is an estimation or generalization of weather changes in the next 24 to 48 hours, and varies from location to location. The tendency is simply a tool for projecting weather conditions and is never to be relied upon as an accurate method to predict the weather.</p>

11. Accessories

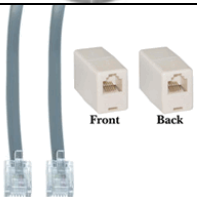
The following software and hardware accessories are available for this weather station at www.AmbientWeather.com.

Accessory	Image	Description
Ambient Weather BCY29 4 in 1 Pocket Precision Screwdriver		This precision screwdriver kit is a must for assembling this weather station due to the small, precision screws.
Weather Station Mounting Solutions		Pole mounting solutions, tripods, mast to mast mounting kits. The WS-1080 pole mount can be attached to a pole mounting solution with the included hose clamps.
D4 Universal Weather Station Console Desk Stand		Universal desk stand allows the display console to stand upright.
Cumulus Software by Sandaysoft www.sandaysoft.com		Free internet publishing software allows you to publish to the internet real time. Supports www.WeatherUnderground.com and CWOP/APRS. Choose the Fine Offset weather station option.
WeatherSnoop Weather Underground Publishing Mac Software 		WeatherSnoop connects your weather station to your Mac to the WeatherUnderground with a simple, easy to use interface. WeatherSnoop stores all of your weather data locally in a compact SQLite database. This data can then be used by other applications for detailed analysis and trending.
Weather Exchange		Free internet client software receives data posted by www.WeatherUnderground.com and allows you to view your weather station data real time, along with thousands of other weather stations. Includes forecasts, radar and alarms.
Kestrel Instruments Silva Polaris Handheld Compass for Anemometer Calibration		Handheld compass for wind direction calibration.
Energizer AA Lithium Battery (2-pack) - Batteries for Long Life and Cold Climates		AA lithium batteries for cold weather climates.

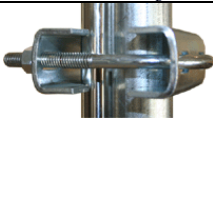
Accessory	Image	Description
SRS100LX Temperature and Humidity Solar Radiation Shield		Solar Radiation Shield improves temperature accuracy for hot weather climates. Remove the rain guard and install over thermo-hygrometer.
Cable Extensions		Cable extension kits allow you to extend the cables between the anemometer and rain gauge to the thermo-hygrometer, improving the flexibility of the installation.
WS-1080-C Wireless Home Weather Station (Console Only)		Add as many wireless display consoles as you like. This allows you to free up a display console for your computer and one for different rooms in your house or business.
WeatherHub AMBNSLU2 Universal IP Ethernet Server		The WeatherHub2 is a data logger and IP Ethernet Weather Station Server in one. Simply plug the WeatherHub2 data logger into the back of your console and connect the cable to your cable/DSL router. Within minutes, you'll be able to see your weather data live on the Internet. Allows you to turn off your PC. Perfect for remote monitoring.
WS-1080 Weather Station Replacement Parts and Accessories		Ambient Weather provides all replacement and warranty parts for the WS-1080 weather station. The weather station includes a 1 year factory warranty.
Ambient Weather P2P2 Mast to Mast Mounting Kit		The P2P2 mast to mast reduction kit is used with any of Ambient Weather's mounting pole kits, and allows you to mount smaller diameter poles to larger diameter poles, providing a solid mounting solution. Replaces hose clamps included with weather station for improved mounting stability.

12. Liability Disclaimer

Please help in the preservation of the environment and return used batteries to an authorized depot. The electrical and electronic wastes contain hazardous substances. Disposal of electronic waste in wild country and/or in unauthorized grounds strongly damages the environment.

Reading the “User manual” is highly recommended. The manufacturer and supplier cannot accept any responsibility for any incorrect readings and any consequences that occur should an inaccurate reading take place.

This product is designed for use in the home only as indication of weather conditions. This product is not to be used for medical purposes or for public information.

The specifications of this product may change without prior notice.

This product is not a toy. Keep out of the reach of children.

No part of this manual may be reproduced without written authorization of the manufacturer.

Ambient, LLC WILL NOT ASSUME LIABILITY FOR INCIDENTAL, CONSEQUENTIAL, PUNITIVE, OR OTHER SIMILAR DAMAGES ASSOCIATED WITH THE OPERATION OR MALFUNCTION OF THIS PRODUCT.

13. FCC Statement

Statement according to FCC part 15.19:

This device complies with part 15 of the FCC rules. Operation is subject to the following two conditions:

1. This device may not cause harmful interference.
2. This device must accept any interference received, including interference that may cause undesired operation.

Statement according to FCC part 15.21:

Modifications not expressly approved by this company could void the user's authority to operate the equipment.

Statement according to FCC part 15.105:

NOTE: This equipment has been tested and found to comply with the limits for a Class B digital device, pursuant to Part 15 of the FCC Rules. These limits are designed to provide reasonable protection against harmful interference in a residential installation. This equipment generates, uses and can radiate radio frequency energy and, if not installed and used in accordance with the instructions, may cause harmful interference to radio communications.

However, there is no guarantee that interference will not occur in a particular installation. If this equipment does cause harmful interference to radio or television reception, which can be determined by turning the equipment off and on, the user is encouraged to try to correct the interference by one or more of the following measures:

- Reorient or relocate the receiving antenna.
- Increase the separation between the equipment and receiver.
- Connect the equipment into an outlet on a circuit different from that to which the receiver is connected.
- Consult the dealer or an experienced radio/TV technician for help.

14. Warranty Information

Ambient, LLC provides a 1-year limited warranty on this product against manufacturing defects in materials and workmanship.

This limited warranty begins on the original date of purchase, is valid only on products purchased and only to the original purchaser of this product. To receive warranty service, the purchaser must contact Ambient, LLC for problem determination and service procedures.

Warranty service can only be performed by Ambient, LLC. The original dated bill of sale must be presented upon request as proof of purchase to Ambient, LLC.

Your Ambient, LLC warranty covers all defects in material and workmanship with the following specified exceptions: (1) damage caused by accident, unreasonable use or neglect (lack of reasonable

and necessary maintenance); (3) damage resulting from failure to follow instructions contained in your owner's manual; (4) damage resulting from the performance of repairs or alterations by someone other than an authorized Ambient, LLC authorized service center; (5) units used for other than home use (6) applications and uses that this product was not intended (7) the products inability to receive a signal due to any source of interference or metal obstructions and (8) extreme acts of nature, such as lightning strikes or floods.

This warranty covers only actual defects within the product itself, and does not cover the cost of installation or removal from a fixed installation, normal set-up or adjustments, claims based on misrepresentation by the seller or performance variations resulting from installation-related circumstances.

