WS-11 Wireless 8 Channel Advanced Weather Station with Temperature Spectrum Color Changing Backlight User Manual



Table of Contents

1	Introduction.....	2
2	Getting Started	2
2.1	Parts List.....	2
2.2	Recommend Tools	3
2.3	Thermo-Hygrometer Sensor Set Up.....	3
2.4	Display Console Set Up	5
2.4.1	Display Console Layout.....	6
2.4.2	Sensor Operation Verification	7
3	Remote Sensor Installation	8
4	Display Features.....	8
4.1	Comfort Icon	8
4.2	Low Battery Icon.....	8
5	Console Operation.....	9
5.1	Quick Display Mode	9
5.4	Sensor Search Mode.....	13
5.5	History Graph Mode.....	13
5.6	Reset Min/Max record.....	13
5.7	Snooze Mode.....	14
5.8	Backlight Mode.....	14
5.9	Adjustment or Calibration	15
5.9.1	Temperature Calibration.....	15
5.9.2	Setting Calibrated Humidity.....	15
5.9.3	Setting Calibrated Barometric Pressure	16
6	Alarm Mode	17
6.1	Alarm Operation.....	17
6.2	Alarm Settings.....	17
6.3	Setting the Alarms	17
6.4	Alarm and Command Key Beeper ON/OFF Mode.....	18
7	Other Console Features	18
7.1	Weather Forecasting	19
7.2	Weather Icons	19

7.3	Storm Threshold Indicator.....	20
7.4	Pressure Threshold Setting.....	20
7.5	Personalizing Color Ranges.....	20
8.	Glossary of Terms.....	21
9.	Specifications.....	21
9.1	Wireless Specifications.....	21
9.2	Measurement Specifications.....	22
9.3	Power Consumption.....	22
10	Troubleshooting Guide.....	22
11	Accessories.....	24
12	Liability Disclaimer.....	24
13	FCC Statement.....	24
14	Warranty Information.....	25

1 Introduction

Thank you for your purchase of the WS-11 Wireless 8 Channel Advanced Weather Station. The following user guide provides step by step instructions for installation, operation and troubleshooting. To download the latest manual and additional troubleshooting tips, please visit:

<http://ambientweather.wikispaces.com/ws11>

2 Getting Started

 **Note:** The power up sequence must be performed in the order shown in this section (insert batteries in the remote transmitter(s) first, Display Console second).

The unit consists of a display console (receiver), and a thermo-hygrometer (remote transmitter).

2.1 Parts List

QTY	Item
1	Display Console Frame Dimensions (LxHxW): 7.7 x 5.4 x 1.1 in LCD Dimensions (LxW): 5.1 x 4.3in
1	Thermo-hygrometer transmitter (FT007TH) Dimensions (LxHxW): 4.5 x 2.0 x 0.75in
1	Manual
1	Power Adapter

2.2 Recommend Tools

Hammer and nail for hanging remote thermo-hygrometer transmitter.

2.3 Thermo-Hygrometer Sensor Set Up

1. Remove the battery door on the back of the sensor by removing the set screw, as shown in Figure 1.

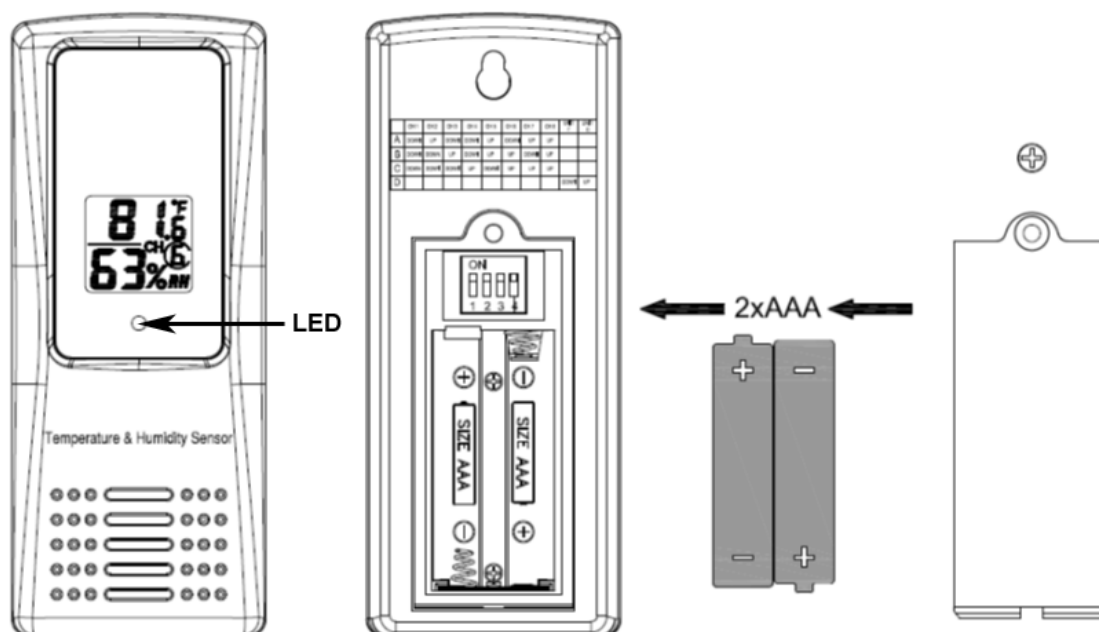

Figure 1

2. **BEFORE** inserting the batteries, locate the dip switches on the inside cover of the lid of the transmitter.

Figure 2 displays all four switches in the OFF position (factory default setting).



Figure 2

3. **Channel Number:** The WS-11 supports up to eight transmitters. To set each channel number (the default is Channel 1), change Dip Switches 1, 2 and 3, as referenced in Table 1.
4. **Temperature Units of Measure:** To change the transmitter display units of measure (°F vs. °C), change Dip Switch 4, as referenced in Table 1.

DIP SWITCH				FUNCTION
1	2	3	4	
DOWN	DOWN	DOWN	---	Channel 1
DOWN	DOWN	UP	---	Channel 2
DOWN	UP	DOWN	---	Channel 3
DOWN	UP	UP	---	Channel 4
UP	DOWN	DOWN	---	Channel 5
UP	DOWN	UP	---	Channel 6
UP	UP	DOWN	---	Channel 7
UP	UP	UP	---	Channel 8
---	---	---	DOWN	°F
---	---	---	UP	°C

Table 1

5. Insert two AAA batteries.
6. After inserting the batteries, the remote sensor LED indicator will light for 4 seconds, and then flash once per 60 seconds thereafter. Each time it flashes, the sensor is transmitting data.
7. Verify the correct channel number (CH) and temperature units of measure (°F vs. °C) are on the display, as shown in Figure 3.

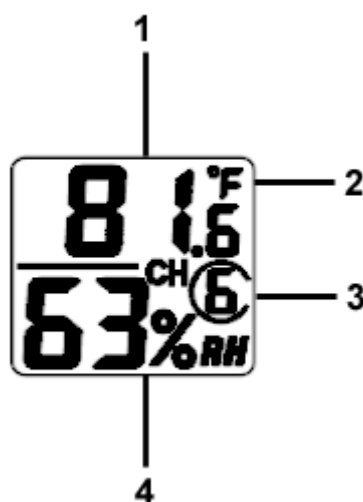



Figure 3

- (1) temperature
 - (2) temperature units (°F vs. °C)
 - (3) channel number
 - (4) relative humidity
8. Close the battery door. Make sure the gasket (around the battery compartment) is properly seated in its trace prior to closing the door. Tighten the set screw.

2.4 Display Console Set Up

1. Move the remote thermo-hygrometer(s) about 5 to 10' away from the display console (if the sensor is too close, it may not be received by the display console). If you have more than one transmitter, make sure they are all powered up and transmitting on different channels.
2. Remove the battery door on the back of the display, as shown in Figure 4. Insert four AA (alkaline or lithium) batteries in the back of the display console.

The display will beep once and all of the LCD segments will light up for a few seconds to verify all segments are operating properly. The console will cycle through a spectrum of colors.

 **Note:** The character contrast is best from a slightly elevated viewing angle.

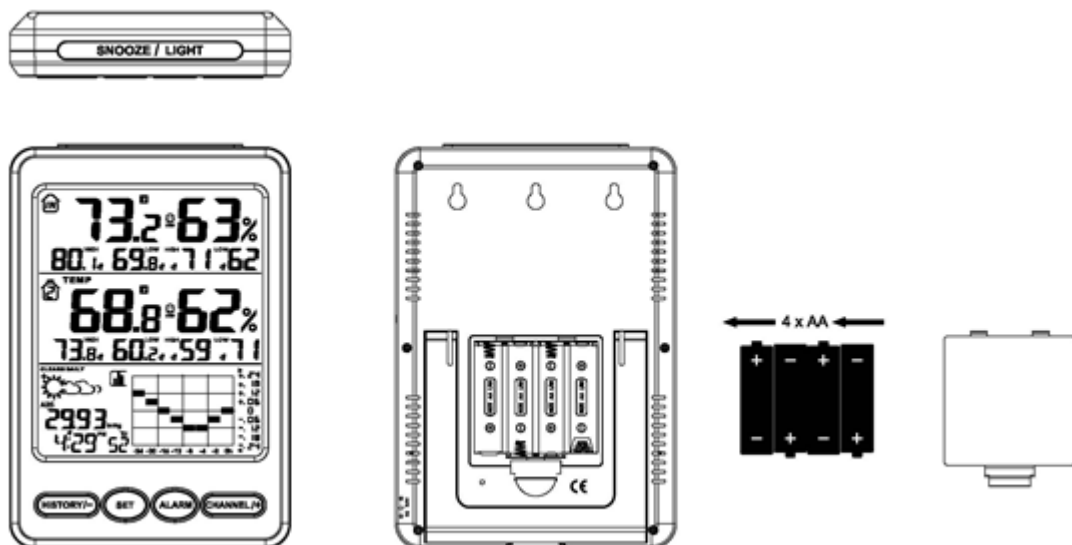



Figure 4

3. Replace the battery door, and fold out the desk stand and place the console in the upright position.

The console will instantly display indoor temperature, humidity, barometer, tendency, date and time. The remote temperature and humidity will update on the display within a few minutes on the appropriate channel.

While in the search mode, the remote search icon  will be constantly displayed.

If you have more than once remote sensor (up to eight remotes are supported), the display will automatically toggle between sensors until all sensors have reported in.

Do not touch any buttons until the remote sensor has reported in, or the radio search icon  is no longer on, otherwise the remote sensor search mode will be terminated. When the remote sensor temperature and humidity has been received, the console will automatically switch to the normal mode, and all further settings can be performed.

If the remote does not update, please reference the troubleshooting guide in Section 10.



 **Note:** The power adapter is intended to be correctly oriented in a vertical or floor mounted position. The prongs are not designed to hold the plug in place if it is plugged into a ceiling, under-the-table or cabinet outlet.

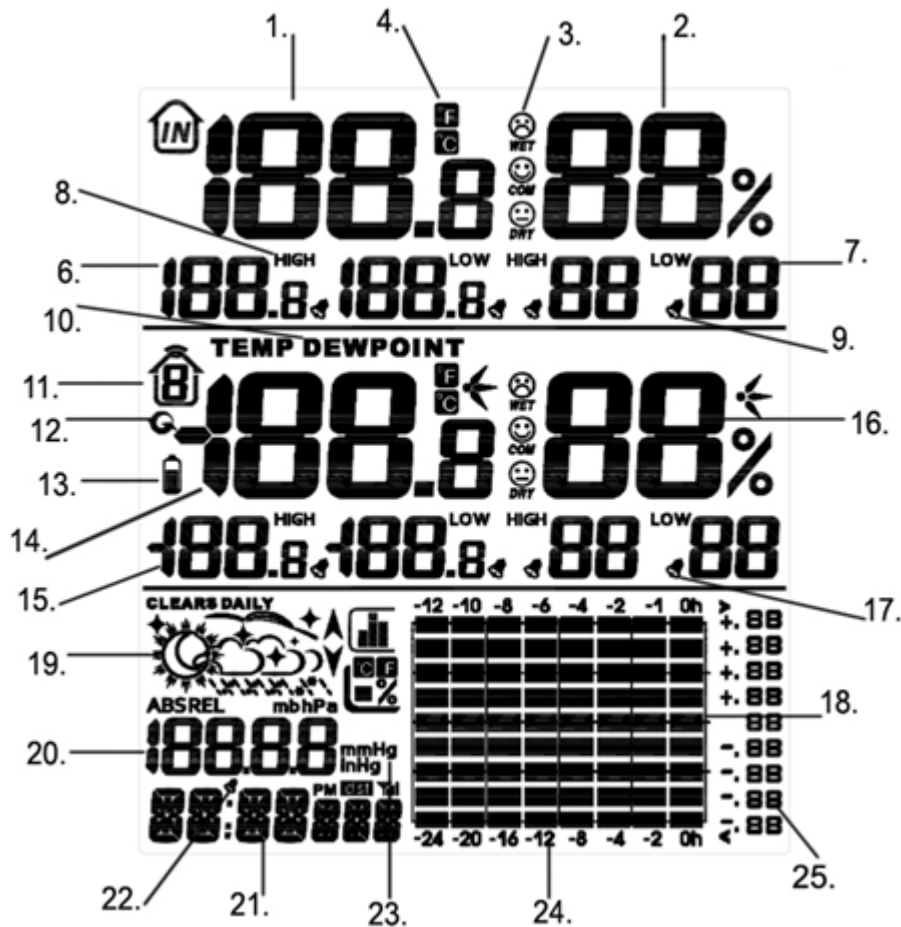

Figure 5

 **Note:** If the power adapter is plugged in, **AC ON** will display in the time area for three seconds when powered up. Conversely, if the power adapter is not plugged in, **AC OFF** will be displayed.

2.4.1 Display Console Layout

 **Note:** The following illustration shows the full segment LCD display for description purposes only and will not appear like this during normal operation.



- | | |
|--|---|
| 1. Indoor temperature display | 12. Scroll mode indicator |
| 2. Indoor humidity display | 13. Low power indicator |
| 3. Humidity Comfort Icon | 14. Outdoor temperature display |
| 4. Temperature units (°F or °C) | 15. Outdoor temperature and humidity Mix/Max information |
| 6. Indoor temperature and humidity Mix/Max information | 16. Outdoor humidity display |
| 7. Indoor and outdoor humidity low alarm and high alarm | 17. Outdoor alarm icon |
| 8. Indoor and outdoor temperature low alarm and high alarm | 18. Temperature, humidity and pressure history graph |
| 9. Indoor alarm icon | 19. Weather tendency indicator |
| 10. Dew point temperature display | 20. Barometer air pressure |
| 11. Channel 1,2,3,4,5,6,7,8 indicator | 21. Time and date |
| | 22. Time alarm |
| | 23. Pressure display unit (inhg, hpa or mmHg) |
| | 24. Time format of history graph (12h or 24h) |
| | 25. Temperature, humidity and pressure variation in past 12h or 24h |

Figure 6

2.4.2 Sensor Operation Verification

Verify the indoor and outdoor humidity match closely with the console and sensor array in the same location (about 5 to 10' apart). The sensors should be within 10% (the accuracy is $\pm 5\%$). Allow about 30 minutes for both sensors to stabilize. The humidity can be adjusted or calibrated later to match each other a known source.

Verify the indoor and outdoor temperature match closely with the console and sensor array in the

same location (about 5 to 10' apart). The sensors should be within 3°F (the accuracy is $\pm 2^\circ\text{F}$). Allow about 30 minutes for both sensors to stabilize. The temperature can be adjusted or calibrated later to match each other or a known source.

3 Remote Sensor Installation

It is recommended you mount the remote sensor outside in a shaded area. A north facing wall is preferred because it is in the shade most of the day. Direct sunlight and radiant heat sources will result in inaccurate temperature readings. Although the sensor is water resistant, it is best to mount in a well protected area, such as under an eave. Use a screw or nail (not included) to affix the remote sensor to the wall, as shown in Figure 7.

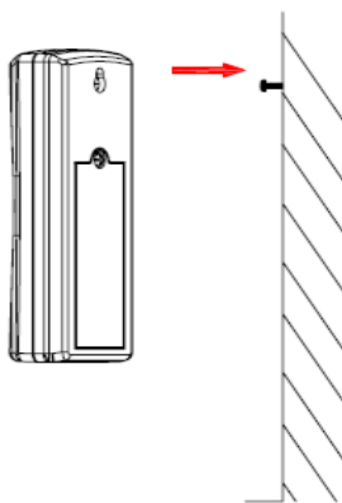

Figure 7

4 Display Features

4.1 Comfort Icon

The comfort icon is based on humidity ranges specified in Figure 8. The icon is displayed for indoor humidity, remote channel 1 humidity and optional remote channels 2 through 8 humidity.



RH<45%	RH 45%~65%	RH >65%
		
Dry	Comfortable	Wet

Figure 8

4.2 Low Battery Icon

A low battery indicator icon is shown in the display window for each sensor. When the low battery

icon appears (the battery voltage is lower than 2.4V), replace the batteries in the sensor with fresh batteries. Be sure to never mix old and new batteries, and never mix battery types such as alkaline and lithium together.

5 Console Operation

 **Note:** The console has five keys for easy operation: **HISTORY/-** key, **SET** key, **ALARM** key, **CHANNEL/+** and **SNOOZE/LIGHT** key.

5.1 Quick Display Mode

While in Normal Mode, press (do not hold) the **SET** key to enter the Quick Display Mode as follows:

- once for time, date and time/week,
- twice for absolute pressure and relative pressure,
- three times for outdoor temperature and dew point
- four times for 12h or 24h graph record

1. **Time, Date, Time/Week.** Press the **CHANNEL/+** or **HISTORY/-** key to toggle between Time, Date, Time/Week
2. **Absolute Pressure and Relative Pressure.** Press the **CHANNEL/+** or **HISTORY/-** key to toggle between absolute and relative pressure.
3. **Outdoor Temperature and Dew Point.** Press the **CHANNEL/+** or **HISTORY/-** key to toggle between the outdoor temperature and dew point.
4. **12h or 24h Graph Record.** Press the **CHANNEL/+** or **HISTORY/-** key to toggle between the last -12 hours or -24 hours record time. Each bar represents the corresponding data and time for pressure, temperature or humidity.(default is -24 hours)

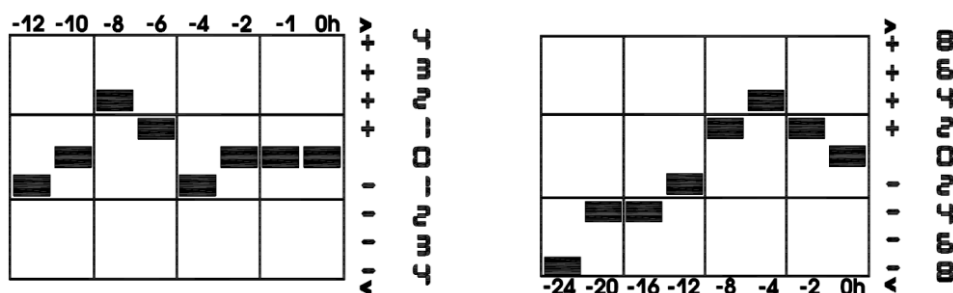





Figure 9

 **Note:** The graph displays hours on the horizontal or x-axis (the most recent data to the right of the graph). For example, 0h is the current data and -12 is 12 hours ago. The vertical axis or y-axis auto-scales, displays the deviation from the current value (the most recent data will always display 0). For example, when in temperature mode, if the bar displays +4, this represents 4 degrees higher than the current value.

5.2 Set (Program) Mode

While in Normal Mode, **press and hold** the **SET** key for at least three seconds to enter the Set Mode. The first setting will begin flashing. You can press the **SET** key again to skip any step, as defined below.

 **Note:** In the Set mode, press the [+] key or [-] key to change or scroll the value. Hold the [+] key or [-] key for three seconds to increase/decrease rapidly.

 **Note:** In Set mode, to enter the normal mode, complete all set mode operations or wait 30 seconds for timeout.

1. **12/24 Hour Format (default: 12h):** Press the **SET** key again to adjust the 12/24 hour format setting (FMT). Press the [+] key to change between 12 hour and 24 hour format.
2. **Change Hour.** Press the **SET** key again to set the hour. Press the [+] key or [-] key to adjust the hour up or down. Note the PM icon is present during afternoon hours.
3. **Change Minute.** Press the **SET** key again to set the minute. Press the [+] key or [-] key to adjust the minute up or down.
4. **Date Format (default: DD-MM):** Press the **SET** key again to enter the day/month format mode. Press the [+] key to switch between MM-DD-YY, DD-MM-YY or YY-MM-DD.
5. **Change Day.** Press the **SET** key again to set the calendar day. Press the [+] key or [-] key to adjust the calendar day.
6. **Change Month.** Press the **SET** key again to set the calendar month. Press the [+] key or [-] key to adjust the calendar month.
7. **Change Year.** Press the **SET** key again to set the calendar year. Press the [+] key or [-] key to adjust the calendar year.
8. **Max/Min Clearing.** Press the **SET** key again to set the max/min clearing mode (CLR). The Max/Min can be programmed to clear daily (at midnight) or manually. Press the [+] key to switch between “Clears Daily” and Clears Manually.
9. **Temperature Units of Measure (default: °F):** Press the **SET** key again to change the temperature units of measure (the **UNITSET** icon will be displayed). Press the [+] key to switch between °F and °C units of measure.
10. **Barometric Pressure Display Units** (mmhg, inHg or hPa). Press the **SET** key again to change the pressure units of measure (the **UNITSET** icon will be displayed). Press the [+] key to toggle the pressure units between mmhg, inHg or hPa.
11. **Pressure Threshold Setting (default level 2).** Press the **SET** key again adjust the Pressure threshold setting (the **WEATHER** icon will be displayed). Press [+] key or [-] key to adjust the pressure threshold setting up or down. Refer to Section 7.4 for more details on this function.
12. **Storm Threshold Setting (default level 4).** Press the **SET** key again entering into the storm threshold setting (the **STORM** icon will be displayed). Press the [+] key or [-] key to adjust the storm threshold up or down. Refer to Section 7.3 for more details on this function.
13. **Weather Forecast Icon Setting (default: partly cloudy).** Press the **SET** key again to set the weather forecast icon initial conditions (based on the current weather conditions). Press the [+]

key or [-] key to toggle weather icons between sunny, partly cloudy, cloudy, or rainy.

 **Note:** On a sunny day, from 7:01 am to 6:59 pm, the daytime icon is displayed (sun).

From 7:00 pm to 7:00 am, the nighttime icon is displayed (moon and stars).

14. **Backlight Color Setting (default: OUT).** Press the **SET** key again to set the backlight color defined parameter (the **LED** icon will be displayed). Press [+] key or [-] key to toggle between **IN** (uses the indoor temperature to automatically display backlight color), **OUT** (uses the channel 1 temperature to automatically display backlight color) or **USE** (manually set your own backlight color to one of 11 choices).

The following section is based on the IN, OUT or USE setting selected.

- 14.1 **IN** Backlight Color Setting (reference Figure 10).
- 14.2 **Indoor Backlight Color Low (IN default: 58):** Press the **SET** key again to change the lower range of the color changing backlight spectrum (the **LOWER** icon will be displayed). Press the [+] key or [-] key to adjust the low temperature limit.
- 14.3 **Indoor Backlight Color High (default: 85):** Press the SET key again to change the upper range of the color changing backlight spectrum (the **UPPER** icon will be displayed).
- 14.4 **OUT** Backlight Color Setting uses Channel 1 (reference Figure 10).
- 14.5 **Outdoor Backlight Color Low (OUT default: 10):** Press the **SET** key again to change the lower range of the color changing backlight spectrum (the **LOWER** icon will be displayed). Press the [+] key or [-] key to adjust the low temperature limit.
- 14.6 **Indoor Backlight Color High (default: 100):** Press the SET key again to change the upper range of the color changing backlight spectrum (the **UPPER** icon will be displayed).
- 14.7 **USE** Backlight Color Setting (reference Figure 10).
- 14.8 **Backlight Color (USE):** Press the **SET** key again to manually select the backlight color (the **COLOR** icon will be displayed). Press [+] key or [-] key to choose among 11 different colors.

The following table provides 11 different backlight colors for reference:

No	Color (USE)	Colors	Outdoor Temperature (CH1)	Indoor Temperature	Comments (Manually set maximum and minimum values)
0	Cold Purple		<10	<58	LOW
1	Fuchsia		10-20	58-61	Color Increment = (HI-LOW)/9
2	Purple		20-30	61-64	
3	Blue		30-40	64-67	
4	Aqua		40-50	67-70	
5	Dark Green		50-60	70-73	
6	Light Green		60-70	73-76	
7	Yellow		70-80	76-79	
8	Orange		80-90	79-82	
9	Red		90-100	82-85	
10	Red Hot		>100	>85	HI

Figure 10

 Note: This manual is not printed in color. To view the actual color chart, visit:

<http://site.ambientweatherstore.com/Manuals/ws11.pdf>

to view the actual color.

 Note: Reference **Section 7.5 Personalizing Color Ranges** to modify the color changes to best suit your comfort level and location.





15. **Backlight Contrast:** Press the **SET** key again to change the backlight brightness (the **BRIGHT** icon will be displayed). Press the **[+]** key or **[-]** key to adjust the backlight contrast from 1 (dim) to 8 (bright).

5.3 Channel Selection

Press the **CHANNEL/+** button to switch the display between remote sensors 1 through 8, and scroll mode . In scroll mode, all of the indoor and detected outdoor sensors will be displayed in five second intervals.

5.4 Sensor Search Mode

If any of the sensor communication is lost, dashes (---) will be displayed on the screen. To reacquire the signal:

1. If a specific channel is lost, press the **CH/+** button to display this channel, then Press and hold the **CH/+** button for **3** seconds, and the remote search icon  will be constantly displayed for up to 3 minutes. Once the signal is reacquired, the remote search icon  will turn off, and the current values will be displayed.
2. If new sensors are added, subtracted, or multiple sensor channels are lost, Press and hold the **CH/+** button for **5** seconds (on any channel), and the remote search icon  will be constantly displayed for up to 10 minutes. Once the signal is reacquired, the remote search icon  will turn off, and the current values will be displayed.

5.5 History Graph Mode

The historical graph on the display changed to display the measured parameters.

In normal mode, press the **HISTORY/-** key to toggle between:

- the barometer graph (the **BAROREL** icon is displayed),
- indoor temperature graph (the **TEMP-IN** icon is displayed)
- indoor humidity graph (the **HUMI-IN** icon is displayed)
- outdoor temperature graph (the **TEMPOUT** icon is displayed)
- outdoor humidity graph (the **HUMIOUT** icon is displayed)

5.6 Reset Min/Max record

If you own more than one remote sensor, press the **CHANNEL/+** button first to display the specific channel you wish to clear.

In normal mode press and hold the **HISTORY/-** key for 3 seconds, and the maximum values will

begin flashing and the **MAX CLR** icon will be displayed. Press the **SET** key to clear the maximum values. The maximum values will now display the current values.

Press the **HISTORY/-** key again (do not hold), and the minimum values will begin flashing and the **MIN CLR** icon will be displayed. Press the **SET** key to clear the minimum values. The minimum values will now display the current values.

Press the **ALARM** key to exit the min/max checking and cleaning mode, return to normal display mode.

5.7 Snooze Mode

If the alarm sounds, and you wish to silence the alarm, press the **SNOOZE/LIGHT** key, the backlight will turn. The alarm icon will continue to flash and the alarm will silence for five minutes. Press any key (**HISTORY/+**, **SET**, **ALARM**, **CHANNEL/+**) to permanently exit the **Snooze** mode.

5.8 Backlight Mode

IF the LED is off, press the **LIGHT** button once. The backlight will turn on for five seconds, and if no operation is performed for three seconds, the backlight will turn off.

Press and hold the **LIGHT** key for two seconds, and the backlight will turn on permanently, and display **LED ON** icon will be displayed for three seconds in the time field.

IF the LED is on, press and hold the **LIGHT** button once, and the LED will turn off.

 **Note:** To dim the backlight display, press the **SNOOZE/LIGHT** button (on the top of the console) to toggle the backlight contrast level between 1 (the lowest setting) and the current setting (1-8).

 **Note:** To easily adjust the backlight when the backlight is on, press the **SNOOZE/LIGHT** button twice in quick succession to enter the **Backlight Contrast** Mode. **BRIGHT 4** will be displayed. Press **[+]** key or **[-]** key to adjust contrast value from 1 to 8, and press the **SET** key to exit.

 **Note:** If plugged into AC power, the time area will display **AC ON** and the backlight will remain on. It is not recommended leaving the backlight on for a long period of time when operating on batteries only, or the batteries will run down quickly.

5.9 Adjustment or Calibration

 **Note:** The calibrated value can only be adjusted on the console. The remote sensor(s) always displays the un-calibrated or measured value.

 **Note:** The measured humidity range is between 10 and 99%. Humidity cannot be accurately measured outside of this range. Thus, the humidity cannot be calibrated below 10% or above 99%.

The purpose of calibration is to fine tune or correct for any sensor error associated with the devices margin of error. The measurement can be adjusted from the console to calibrate to a known source.

Calibration is only useful if you have a known calibrated source you can compare it against, and is optional. This section discusses practices, procedures and sources for sensor calibration to reduce manufacturing and degradation errors. Do not compare your readings obtained from sources such as the internet, radio, television or newspapers. They are in a different location and typically update once per hour.

The purpose of your weather station is to measure conditions of your surroundings, which vary significantly from location to location.

The WS-110 supports up to eight remote sensors. Each of the eight sensors can be calibrated.

If you own more than one remote sensor, press the **CHANNEL/+** button first to display the specific channel you wish to calibrate.

5.9.1 Temperature Calibration

In normal mode, press and hold the **SET** and **CHANNEL/+** keys at the same time for five seconds to enter the temperature calibration mode. The indoor temperature will begin flashing.

Press the **[+]** or **[-]** key to increase or decrease the temperature reading (in increments of 0.1). Press and hold the **[+]** or **[-]** key for three seconds to increase or decrease rapidly.

Press the **SET** key switch to next channel (1through 8). If no operation is performed, the calibration mode will timeout in 30 seconds.

To restore to factory default, press the **ALARM** key to reset current value.

5.9.2 Setting Calibrated Humidity

In normal mode, press and hold the **SET** and **HISTORY/-** keys at the same time for five seconds to enter the humidity calibration mode. The indoor humidity will begin flashing.

Press the [+] or [-] key to increase or decrease the humidity reading (in increments of 1%). Press and hold the [+] or [-] key for three seconds to increase or decrease rapidly.

Press the **SET** key switch to next channel (1 through 8). If no operation is performed, the calibration mode will timeout in 30 seconds.

To restore to factory default, press the **ALARM** key to reset current value.

 **Note:** Humidity is a difficult parameter to measure accurately and drifts over time. The calibration feature allows you to zero out this error. To calibrate humidity, you will need an accurate source, such as a sling psychrometer or Humidipaks One Step Calibration kit.

5.9.3 Setting Calibrated Barometric Pressure

In normal mode, press and hold the **SET** and **ALARM** keys at the same time for five seconds to enter the barometric pressure calibration mode. The absolute relative pressure (ABS) will begin flashing.

1. **Absolute Pressure.** Press the [+] or [-] key to increase or decrease the absolute pressure reading (in increments of 0.01). Press and hold the [+] or [-] key for three seconds to increase or decrease rapidly.

Press the **SET** key to adjust the relative pressure.

To restore to factory default, press the **ALARM** key to reset current value.

2. **Relative Pressure.** Press the [+] or [-] key to increase or decrease the relative pressure reading (in increments of 0.01). Press and hold the [+] or [-] key for three seconds to increase or decrease rapidly.

Press the SET key to exit the calibration mode. If no operation is performed, the calibration mode will timeout in 30 seconds.

To restore to factory default, press the **ALARM** key to reset current value.

 **Note:** The absolute pressure setting should not require adjusting, but if you do adjust the absolute pressure, exit the calibration mode before adjusting the relative pressure.

 **Note:** The display console displays two different pressures: absolute (measured) and relative (corrected to sea-level).

To compare pressure conditions from one location to another, meteorologists correct pressure to sea-level conditions. Because the air pressure decreases as you rise in altitude, the sea-level corrected pressure (the pressure your location would be at if located at sea-level) is generally higher than your measured pressure.

Thus, your absolute pressure may read 28.62 inHg (969 mb) at an altitude of 1000 feet (305 m), but the relative pressure is 30.00 inHg (1016 mb).

The standard sea-level pressure is 29.92 in Hg (1013.2hpa). This is the average sea-level pressure around the world. Relative pressure measurements greater than 29.92 inHg (1013.2hpa) are considered high pressure and relative pressure measurements less than 29.92 inHg are considered low pressure.

To determine the relative pressure for your location, locate an official reporting station near you (the internet is the best source for real time barometer conditions, such as Weather.com or Wunderground.com), and set your weather station to match the official reporting station.

6 Alarm Mode

The WS-11 includes time alarm, temperature alarm and humidity alarm features for indoor and Channel 1.

6.1 Alarm Operation

When an alarm condition is exceeded, the alarm icon will flash  (visual) and the alarm beeper will sound (audible). To silence the beeper, press any key. The alarm beeper can be permanently silenced by referencing Section 6.4.

6.2 Alarm Settings

Time of day, indoor and channel 1 alarms are supported. Channels 2-8 alarms are not supported.

To view the current alarm settings, press the **ALARM** key to enter the alarm mode.

6.3 Setting the Alarms

To set the alarms, press and hold the **SET** key for three seconds. The alarm parameter will begin flashing. To adjust the alarm parameter, press the [+] or [-] key to increase or decrease the alarm setting slowly, or press and hold the [+] or [-] key for three seconds to increase or decrease the alarm setting rapidly.

Press the **ALARM** key to turn on (the alarm icon will appear ) and off the alarm.

To save the alarm setting and proceed to the next alarm parameter, press (do not hold) the **SET** key.

After 30 seconds of inactivity, the alarm mode will time out and return to normal mode.

The following is a list of the individual alarm parameters that are set (in order):

1. Alarm hour
2. Alarm minute
3. Indoor temperature high alarm
4. Indoor temperature low alarm
5. Indoor humidity high alarm
6. Indoor humidity low alarm
7. Outdoor 1 (channel 1) temperature high alarm
8. Outdoor 1 (channel 1) temperature low alarm
9. Outdoor 1 (channel 1) dew point high alarm
10. Outdoor 1 (channel 1) dew point low alarm
11. Outdoor 1 (channel 1) humidity high alarm
12. Outdoor 1 (channel 1) humidity low alarm

 **Note:** To prevent repetitive alarming of temperature, there is a 0.9 °F tolerance band. For example, if you set the high alarm to 80.0 °F and silence the alarm, the alarm icon will continue to flash until the temperature falls below 79.1 °F, at which point, the alarm will reset and must increase above 80.0 °F to activate again.

 **Note:** To prevent repetitive alarming of humidity, there is a 4% tolerance band. For example, if you set the high alarm to 60% and silence the alarm, the alarm icon will continue to flash until the humidity falls below 56%, at which point, the alarm will reset and must increase above 60% to activate again.

6.4 Alarm and Command Key Beeper ON/OFF Mode

The beeper can be silenced for both alarms and key strokes.

In normal mode, press and hold the **ALARM** key for five seconds to toggle the beeper on or off (depending on the current setting).

The **BUZZON** (beeper on) or **BUZZOFF** (beeper off) icon will appear in the time area for three seconds. Press and hold the **ALARM** button again for five seconds to toggle the **BUZZON** or **BUZZOFF** command.

7 Other Console Features

The following section describes additional features and display icons.





7.1 Weather Forecasting

 **Note:** The weather forecast or pressure tendency is based on the rate of change of barometric pressure. In general, when the pressure increases, the weather improves (sunny to partly cloudy) and when the pressure decreases, the weather degrades (cloudy to rain).

The weather forecast is an estimation or generalization of weather changes in the next 24 to 48 hours, and varies from location to location. The tendency is simply a tool for projecting weather conditions and is never to be relied upon as an accurate method to predict the weather.

7.2 Weather Icons

The following icons are displayed based on the rate of change threshold defined in Section 7.4.

Condition	Icon	Description
Sunny		Pressure is rising and the previous condition is partly cloudy.
Stars and Moon		On a sunny day, between 7:00pm and 7:00am (night time), the stars and moon will be displayed instead of the sunny icon.
Partly Cloudy		Pressure is falling and the previous condition is sunny or Pressure is rising and the previous condition is cloudy.
Cloudy		Pressure is falling and the previous condition is partly cloudy or Pressure is rising and the previous condition is rainy.
Rainy		Pressure is falling and the previous condition is cloudy.



Sunny and high pressure		Previous condition is sunny and pressure continuous to rise, designating rising, high pressure system.
Rainy and low pressure		Previous condition is rainy and pressure continuous to fall, designating falling, low pressure system.

Figure 11

7.3 Storm Threshold Indicator

The storm threshold (the negative rate of pressure change signifying a storm is expected) can be adjusted from 3 mbar/hour to level 9 mbar/hour (the default level 4 mbar/hour). The lower the level pressure threshold setting, the higher sensitivity for weather forecast changes. Locations that experience frequent changes in air pressure require a higher setting compared to locations where the air pressure is typically stagnant.

When negative rate of change of pressure is exceeded for three hours, the storm warning indicator will be activated, and the clouds with rain icon will flash for three hours, indicating the storm warning feature is active.

7.4 Pressure Threshold Setting

The pressure threshold (the negative or positive rate of change of pressure signifying a change in the weather) can be adjusted from 2 mbar/hour to 4 mbar/hour (default level 2 mbar/hour).

The lower the level pressure threshold setting, the higher sensitivity for weather forecast changes. Locations that experience frequent changes in air pressure require a higher setting compared to locations where the air pressure is typically stagnant.

7.5 Personalizing Color Ranges

You can customize your background color ranges to suit your location, or personal preferences.

For example, if you live in Alaska, your definition of hot and cold may be very different if you live in Arizona.

Likewise, if you track your indoor comfort level, your comfort range may be very different than someone else.

Example 1: I live in Arizona, and the temperature ranges from 20 °F to 110 °F.

Color Increment = (HI-LOW)/9 = (110 – 20)/9 = 10 °F.

Example 2: I live in Alaska, and the temperature ranges from -20°F to 70°F.

Color Increments = (HI-LOW)/11 = (70 – (-20))/9 = 10 °F.

8. Glossary of Terms

Term	Definition
Accuracy	Accuracy is defined as the ability of a measurement to match the actual value of the quantity being measured.
Hygrometer	A hygrometer is a device that measures relative humidity. Relative humidity is a term used to describe the amount or percentage of water vapor that exists in air.
Range	Range is defined as the amount or extent a value can be measured.
Absolute Barometric Pressure	Relative barometric pressure, corrected to sea-level. To compare pressure conditions from one location to another, meteorologists correct pressure to sea-level conditions. Because the air pressure decreases as you rise in altitude, the sea-level corrected pressure (the pressure your location would be at if located at sea-level) is generally higher than your measured pressure.
Relative Barometric Pressure	Measured barometric pressure relative to your location or ambient conditions.
HectoPascals (hPa)	Pressure units in SI (international system) units of measurement. Same as millibars (1 hPa = 1 mbar)
Inches of Mercury (inHg)	Pressure in Imperial units of measure. 1 inch of mercury = 33.86 millibars

9. Specifications

9.1 Wireless Specifications

- Line of sight wireless transmission (in open air): 300 feet, 100 feet under most conditions.
- Frequency: 433 MHz
- Update Rate: 60 seconds

9.2 Measurement Specifications



The following table provides specifications for the measured parameters.

Measurement	Range	Accuracy	Resolution
Indoor Temperature	32 to 140 °F	± 1 °F	0.1 °F
Outdoor Temperature	-40 to 140 °F	± 1 °F	0.1 °F
Indoor Humidity	10 to 99 %	± 5% (only guaranteed between 20 to 90%)	1 %
Outdoor Humidity	10 to 99%	± 5% (only guaranteed between 20 to 90%)	1 %
Barometric Pressure:	8.85 to 32.50 inHg	± 0.08 inHg	0.01 inHg

9.3 Power Consumption

- Base station (display console) : 4 x AA 1.5V Alkaline or Lithium batteries (not included)
- Remote sensor : 2 x AAA 1.5V Alkaline or Lithium batteries (not included)
- Battery life: Minimum 12 months for base station with one sensor and excellent reception. Intermittent reception and multiple sensors may reduce the battery life.
Minimum 12 months for thermometer-hygrometer sensor (use lithium batteries in cold weather climates less than -4 °F)

10 Troubleshooting Guide

Problem	Solution
<p>Wireless remote (thermo-hygrometer) not reporting in to console.</p> <p>There are dashes (---) on the display console.</p>	<p>If any of the sensor communication is lost, dashes (---) will be displayed on the screen. To reacquire the signal, press and hold the CHANNEL/+ button for 3 seconds, and the remote search icon  will be constantly displayed. Once the signal is reacquired, the remote search icon  will turn off, and the current values will be displayed.</p> <p>The maximum line of sight communication range is 300 feet and 100 feet under most conditions. Move the sensor assembly closer to the display console.</p> <p>If the sensor assembly is too close (less than 5'), move the sensor assembly away from the display console.</p>

Problem	Solution
	<p>Make sure the remote sensor LCD display is working and the transmitter light is flashing once per 60 seconds.</p> <p>Install a fresh set of batteries in the remote thermo-hygrometer. For cold weather environments, install lithium batteries.</p> <p>Make sure the remote sensors are not transmitting through solid metal (acts as an RF shield), or earth barrier (down a hill).</p> <p>Move the display console around electrical noise generating devices, such as computers, TVs and other wireless transmitters or receivers.</p> <p>Move the remote sensor to a higher location. Move the remote sensor to a closer location.</p>
Temperature sensor reads too high in the day time.	<p>Make sure the thermo-hygrometer is mounted in a shaded area. The pre preferred location is a north facing wall because it is in the shade most of the day. Consider the following radiation shield if this is not possible:</p> <p>http://www.ambientweather.com/amwerspatean.html</p>
Indoor and Outdoor Temperature do not agree	<p>Allow up to one hour for the sensors to stabilize due to signal filtering. The indoor and outdoor temperature sensors should agree within 2 °F (the sensor accuracy is ± 1 °F).</p> <p>Use the calibration feature to match the indoor and outdoor temperature to a known source.</p>
Indoor and Outdoor Humidity do not agree	<p>Allow up to one hour for the sensors to stabilize due to signal filtering. The indoor and outdoor humidity sensors should agree within 10 % (the sensor accuracy is ± 5 %).</p> <p>Use the calibration feature to match the indoor and outdoor humidity to a known source.</p>
Display console contrast is weak	Replace console batteries with a fresh set of batteries.
Outdoor color does not change as expected.	Make sure the outdoor sensor is assigned to Channel 1.

11 Accessories

The following software and hardware accessories are available for this weather station at www.AmbientWeather.com.

Accessory	Description
Energizer AAAS Lithium Battery (2-pack) - Batteries for Long Life and Cold Climates	AAA lithium batteries for cold weather climates.
Ambient Weather SRS100LX Temperature and Humidity Solar Radiation Shield	Solar Radiation Shield improves temperature accuracy for hot weather climates. Remove the rain guard and install over thermo-hygrometer.
Ambient Weather Humidity Calibration Kits	One step calibration kits for digital hygrometers use salt slurry formula to accurately calibrate the indoor and outdoor hygrometers.

12 Liability Disclaimer

Please help in the preservation of the environment and return used batteries to an authorized depot. The electrical and electronic wastes contain hazardous substances. Disposal of electronic waste in wild country and/or in unauthorized grounds strongly damages the environment.

Reading the “User manual” is highly recommended. The manufacturer and supplier cannot accept any responsibility for any incorrect readings and any consequences that occur should an inaccurate reading take place.

This product is designed for use in the home only as indication of weather conditions. This product is not to be used for medical purposes or for public information.

The specifications of this product may change without prior notice.

This product is not a toy. Keep out of the reach of children.

No part of this manual may be reproduced without written authorization of the manufacturer.

Ambient, LLC WILL NOT ASSUME LIABILITY FOR INCIDENTAL, CONSEQUENTIAL, PUNITIVE, OR OTHER SIMILAR DAMAGES ASSOCIATED WITH THE OPERATION OR MALFUNCTION OF THIS PRODUCT.

13 FCC Statement

Statement according to FCC part 15.19:

This device complies with part 15 of the FCC rules. Operation is subject to the following two conditions:

1. This device may not cause harmful interference.
2. This device must accept any interference received, including interference that may cause undesired operation.

Statement according to FCC part 15.21:

Modifications not expressly approved by this company could void the user's authority to operate the equipment.

Statement according to FCC part 15.105:

NOTE: This equipment has been tested and found to comply with the limits for a Class B digital device, pursuant to Part 15 of the FCC Rules. These limits are designed to provide reasonable protection against harmful interference in a residential installation. This equipment generates, uses and can radiate radio frequency energy and, if not installed and used in accordance with the instructions, may cause harmful interference to radio communications.

However, there is no guarantee that interference will not occur in a particular installation. If this equipment does cause harmful interference to radio or television reception, which can be determined by turning the equipment off and on, the user is encouraged to try to correct the interference by one or more of the following measures:

- Reorient or relocate the receiving antenna.
- Increase the separation between the equipment and receiver.
- Connect the equipment into an outlet on a circuit different from that to which the receiver is connected.
- Consult the dealer or an experienced radio/TV technician for help.

14 Warranty Information

Ambient, LLC provides a 1-year limited warranty on this product against manufacturing defects in materials and workmanship.

This limited warranty begins on the original date of purchase, is valid only on products purchased and only to the original purchaser of this product. To receive warranty service, the purchaser must contact Ambient, LLC for problem determination and service procedures.

Warranty service can only be performed by a Ambient, LLC. The original dated bill of sale must be presented upon request as proof of purchase to Ambient, LLC.

Your Ambient, LLC warranty covers all defects in material and workmanship with the following specified exceptions: (1) damage caused by accident, unreasonable use or neglect (lack of reasonable and necessary maintenance); (2) damage resulting from failure to follow instructions contained in your owner's manual; (3) damage resulting from the performance of repairs or alterations by someone other than an authorized Ambient, LLC authorized service center; (4) units used for other than home use (5) applications and uses that this product was not intended (6) the products inability to receive a signal due to any source of interference or metal obstructions and

(7) extreme acts of nature, such as lightning strikes or floods.

This warranty covers only actual defects within the product itself, and does not cover the cost of installation or removal from a fixed installation, normal set-up or adjustments, claims based on misrepresentation by the seller or performance variations resulting from installation-related circumstances.

