

BAOFENG

GMRS Two Way Radio

G11S

User Manual

PREFACE

Thank you for purchasing G11S Two Way Radio, It is a multitask GMRS transceiver. Combining the latest technology in radio communication along with a sturdy mechanical frame, G11S is the ideal and effective solution for the professionals who need to stay in touch with the working team (in construction sites, buildings, shows, trade fairs or hotels) or for leisure users that just want to keep up with friends and family.

IMPORTANT NOTICE

To help you ward off bodily injury or property loss that may arise from improper operation, please read all the information carefully before using our products. This contains instructions for safe usage and RF energy awareness and control for compliance with applicable standards and regulation.

Safety Information for GMRS Radios

Your wireless handheld portable transceiver contains a low power transmitter. When the talk button is pushed, it sends out radio frequency (RF) signals. The device is authorized to operate at a duty factor not to exceed 50%. In August 1996, the Federal Communications Commissions (FCC) adopted RF exposure guidelines with safety levels for handheld wireless devices.

FCC Part 15.21 Warning Statement

THE GRANTEE IS NOT RESPONSIBLE FOR ANY CHANGES OR MODIFICATIONS NOT EXPRESSLY APPROVED BY THE PARTY RESPONSIBLE FOR COMPLIANCE. SUCH MODIFICATIONS COULD VOID THE USER'S AUTHORITY TO OPERATE THE EQUIPMENT.

Table of Contents

1. GETTING STARTED		5. BASIC OPERATIONS	
1.1 Regulations and Safety Warnings	01	5.1 Turning your Radio On and Off	13
1.2 Content of the packaging	06	5.2 Setting the Volume	13
1.3 Main features	06	5.3 Choosing a Channel	13
2. BATTERY INFORMATION		5.4 Talking and Listening	13
2.1 Charging the Battery Pack	07	5.5 SCAN	13
2.2 Charger Supplied	07	5.6 Monitor	14
2.3 How to Charge	08	5.7 Keypad lock	14
2.4 LED Indicator	08	5.8 A/B switch	14
3. INSTALLATION OF ACCESSORIES		5.9 Flashlight and Emergency Alert	14
3.1 Installing / Removing the Antenna	09	5.10 FM Radio (FM)	14
3.2 Installing the belt clip	09	5.11 NOAA Weather Radio	15
3.3 Installing the battery pack	09	5.12 1000Hz, 1450Hz, 1750Hz Tone-burst	15
3.4 Additional Speaker/Microphone (Optional)	09	6. WORKING THE MENU SYSTEM	
4. RADIO OVERVIEW		6.1 Basic use	16
4.1 Main controls and parts of the radio	10	6.2 Shortcut Menu operations	17
4.2 LCD Display	12	6.3 Menu settings	20
		Appendix A. - Trouble shooting guide	26
		Appendix B. - Technical Specifications	27
		Appendix C. - Shortcut Menu operations	28

1. GETTING STARTED

1.1 Regulations and Safety Warnings

This device complies with Part 15 of the FCC Rules. Operation is subject to the following two conditions:

(1) This device may not cause harmful interference.

(2) This device must accept any interference received, including interference that may cause undesired operation.

Important: Any changes or modifications not expressly approved by the party responsible for compliance could void the user's authority to operate this device. Your radio is set up to transmit a regulated signal on an assigned frequency. It is against the law to alter or adjust the settings inside the radio to exceed those limitations. Any adjustments to your radio must be made by qualified technicians.

To be safe and sure:

- Never open your radio's case.
- Never change or replace anything in your radio except the battery.

Your radio might cause TV or radio interference even when it is operating properly. To determine whether your radio is causing the interference, turn it off. If the interference goes away, your radio is causing it. Try to eliminate the interference by moving your radio away from the receiver. If you cannot eliminate the interference, the FCC requires that you stop using the radio.

Hazardous Environments: Do not operate the radio in hazardous environments. Explosion or fire may result.

Do not operate the radio near unshielded electrical blasting caps.

Under certain conditions, radios can interfere with blasting operations and may cause an explosion. Turn your radio OFF to prevent accidental transmission when in a blasting area or in areas posted: "Turn off two-way radio." Construction crews often use remote control RF devices to set off explosives.

Care and Safety: To clean the radio, use a soft cloth dampened with water. Do not use cleaners or solvents because they can harm the body of the unit and leak inside, causing permanent damage. Use a dry, lint-free cloth to clean the battery contacts.

RF Exposure Information

WARNING! Read this information before using the radio. In August 1996 the Federal Communications Commission (FCC) of the United States with its action in Report and Order FCC 96-326 adopted an updated safety standard for human exposure to radio frequency electromagnetic energy emitted by FCC regulated transmitters.

Those guidelines are consistent with the safety standard previously set by both U.S. and international standards bodies. The design of the radio complies with the FCC guidelines and these international standards.

Never allow children to operate the radio without adult supervision and the knowledge of the following guidelines.

WARNING! It is up to the user to properly operate this radio transmitter to insure safe operation. Please adhere to the following:

Use only the supplied or an approved antenna. Unauthorized antennas, modifications, or attachments could impair call quality, damage the radio, or result in violation of FCC regulations.

Do not use the radio with a damaged antenna.

If a damaged antenna comes into contact with the skin, a minor burn may result. Please contact your local dealer for a replacement antenna.

Hand-held Operation (Held-to-Face)

This device was evaluated for typical hand-held (held-to-face) operations with a 1 inch spacing from the front of the radio. For hand-held operation, the radio should be held 1 inch from the user's face in order to comply with FCC RF exposure requirements.

For more information about RF exposure, please visit the FCC web site at www.fcc.gov.

Body-worn Operation

This device was evaluated for body-worn operations with the supplied belt-clip accessory. (All necessary accessories are included in the package; any additional or optional accessories are not required for compliance with the guidelines.) Third party accessories (unless approved by the manufacturer) should be avoided as these might not comply with FCC RF exposure guidelines.

For more information about RF exposure, please visit the FCC web site at www.fcc.gov.

GMRS Communication

This GMRS (General Mobile Radio Service) feature is a land-mobile service available for short-distance, two-way communications in the USA. You must have a valid FCC license to communicate on these channels. The GMRS frequencies that radio this radio uses are set aside for communicating with others while hiking, biking, and working; keeping track of family and friends at a crowded public event; checking with travel companions in another car; talking with neighbors; arranging meeting spots with others while shopping at the mall. Licensed users will be issued a call sign by the FCC, which should be used for station identification when operating this radio. GMRS users should also cooperate by engaging in permissible transmissions only, avoiding channel interference with other GMRS users, and being prudent with the length of their transmission time.

FCC License Required

This two way radio complies with Parts 95 and 15 of the Federal Communications Commission(FCC) Rules. This two-way radio operates on GMRS (General Mobile Radio Service) frequencies which require an FCC (Federal Communications Commission) license. A user must be licensed prior to transmitting on the GMRS band with this radio. Serious penalties could result for unlicensed use of GMRS channels, in violation of FCC rules. Operation of this radio is subject to additional rules specified in 47 C.F.R. Part 95. For licensing information and application forms, please call the FCC Hotline at 800418-FORM. Request form #159 and form #605. Questions regarding the license application should be directed to the FCC at 888-CALL-FCC. Additional information is available on the FCC's website at www.fcc.gov.

NOTE: Even if you operate this radio on FRS (Family Radio Service) channels at low power (0.5 watt), you are required to have an FCC license. Because this radio operates in the 0.5 to 5 watt GMRS power range all GMRS rules apply and will require you have a GMRS license even for FRS (Family Radio Service) communication. Normal FRS only radios operate at a maximum power of 0.5 watt (500 mill watt) power and have an integral (non-detachable) antenna.

Precautions for Portable Terminals

■ Operating Prohibitions

To protect you against any property loss, bodily injury or even death, be sure to observe the following safety instructions:

1. Do not operate the product in a location containing fuels, chemicals, explosive atmospheres and other flammable or

explosive materials. In such location, only an approved Ex-protection model is allowed for use, but any attempt to assemble or disassemble it is strictly prohibited.

2. Do not operate the product near or in any blasting area.
3. Do not operate the product near any medical or electronic equipment that is vulnerable to RF signals.
4. Do not hold the product while driving.
5. Do not operate the product in any area where use of wireless communication equipment is completely prohibited.

Important Tips

To help you make better use of the product, be sure to observe the following instructions:

1. Do not use any unauthorized or damaged accessory.
2. Keep the product at least 2.5 centimeters away from your body during transmission.
3. Do not keep the product receiving at high volume for a long time.
4. For vehicles with an air bag, do not place the product in the area over the air bag or in the air bag deployment area.
5. Keep the product and its accessories out of reach of children and pets.
6. Please operate the product within the specified temperature range.
7. Continuous transmission for a long time may lead to heat accumulation within the product. In this case, please keep it at a proper location for cooling.
8. Handle the product with care.
9. Do not disassemble, modify or repair the product and its accessories without authorization.

■ Precautions for Batteries

Charging Prohibitions

To protect you against any property loss, bodily injury or even death, be sure to observe the following safety instructions:

1. Do not charge or replace your battery in a location containing fuels, chemicals, explosive atmospheres and other flammable or explosive materials.
2. Do not charge your battery that is wet. Please dry it with a soft and clean cloth prior to charge.
3. Do not charge your battery suffering deformation, leakage and overheat.

4. Do not charge your battery with an unauthorized charger.
5. Do not charge your battery in a location where strong radiation is present.
6. Overcharge shall always be prohibited for it may shorten the life of your battery.

Maintenance Instructions

To help your battery work normally or prolong its life, be sure to observe the following instructions:

1. Accumulated dust on charging connector may affect normal charging. Please use a clean and dry cloth to wipe it on a regular basis.
2. It is recommended to charge the battery under 5°C~40°C. Violation of the said limit may cause battery life reduction or even battery leakage.
3. To charge a battery attached to the product, turn it off to ensure a full charge.
4. Do not remove the battery or unplug the power cord during charging to ensure a smooth charging process.
5. Do not dispose of the battery in fire.
6. Do not expose the battery to direct sunlight for a long time nor place it close to other heating sources.
7. Do not squeeze and penetrate the battery, nor remove its housing.

Transportation Instructions

1. Damaged batteries must not be transported.
2. To avoid short circuit, separate the battery from metal parts or from each other if two or more batteries are transported in one packaging.
3. The radio must be switched off and secured against switch-on, if the battery is attached.

The content of the shipment must be declared in the shipping documents and by a Battery Shipping Label on the packaging. Contact your hauler for the local regulations and further information.

1.2 Content of the packaging

- 1 G11S transceiver
- 1 Fast desktop charger
- 1 Belt clip
- 1 Li-Ion battery pack 1500mAh 7.4V
- 1 Wall adaptor

*If any item is missing, please verify with your BAOFENG dealer.

1.3 Main features

- Scanning receiver frequency band: 136.0-174.0 & 400.0-512.0MHz
- 30 GMRS channel transmission (compatible with FSR channel)
- 10 Selectable Call/Call Alerts
- 258 Privacy Codes (50 CTCSS Tones and 208 DCS Codes)
- SOS Emergency function
- Channel Monitor, Channel Scan, Dual Watch functions
- CTCSS and DCS codes research
- Hands-Free Operation (VOX)
- Frequency step: 2.5/5/6.25/10/12.5/25KHz
- VOICE: Vocal indication of the function selected
- Low battery voice indicator
- Support USB (Type-C) charging
- 2pin Kenwood accessory jack
- Output power: 3W
- 11 Channels NOAA Weather Radio
- 1750Hz tone for repeaters
- TOT (Time out timer)30/60/90/120/150/180s
- Busy Channel Lockout function (BCL)
- LED Flashlight
- Squelch adjustable in 9 levels
- Keypad lock
- Battery Saver
- Li-Ion 1500mAh battery pack
- Up to 8 Mile Range*

*Range may vary depending on environmental and/or topographical conditions.

About Range

Your G11S Series radios are designed to give you maximum range under optimum conditions.

- Maximum Range: Little to No sight Obstruction.
- Medium Range: Partial Obstruction to line of sight.
- Short Range: Major Obstruction to Line of Sight.

Optimum Conditions are:

- Over water
- Open rural areas without obstructions
- Flat areas where you can see the other person

To ensure you get maximum range:

- Be sure to use fresh or fully charged batteries - low batteries will cause low power conditions.
- Be sure you are on a GMRS channel - FRS channels are restricted by the FCC to low power.
- Be sure to set your radio to use Hi power.

2. BATTERY INFORMATION

2.1 Charging the Battery Pack

The Li-ion battery pack is not charged at the factory; please charge it before use. Charging the battery pack for the first time after purchase or extended storage (more than 2 months) may not bring the battery pack to its normal maximum operating capacity. Best operation will require fully charging/ discharging the battery two or three times before the operating capacity will reach its best performance. The battery pack life may be depleted when it's operating time decreases even though it has been fully and correctly charged. If this is the case, replace the battery pack.

2.2 Charger Supplied

Please use the specified charger provided by BAOFENG. Other models may cause explosion and personal injury. After installing the battery pack, and if the radio displays low battery with a voice prompt, please charge the battery.

2.3 How to Charge

Your radios include a charging cradle and battery packs. Follow these instructions to recharge your radios.

Make sure to turn the radio OFF before placing the radio in the charging cradle.

- 1) Connect the adapter's plug to DC IN 10V jack of the charging cradle and plug the other end into an AC outlet.
- 2) Set the charging cradle on the desk or tabletop and place the radio in the charging cradle with the keypad facing forward.
- 3) Make sure that the LED illuminates. Charge the battery pack for 6 hours and remove the radio from the charging cradle after charging.

Note:

- Use only the supplied battery and AC adapter or approved accessories from BAOFENG.
- Charge time may vary depending on the battery life remaining.
- The battery must be installed for the unit to operate, even if the unit is also connected to external power.
- If battery power is low, you cannot operate the radio even using external power. Allow the battery to charge before using. If you try to transmit while power is low, the radio will automatically turn off.
- For fastest charging, turn off the radio before charging.

2.4 LED Indicator

STATUS	LED
No Battery	Green and red alternately flashing
Charge Normally	Red
Fully Charged	Green
Trouble	Red blinks fast for a long time

NOTE: Trouble means battery too warm, battery short-circuited or charger short-circuited.

3. INSTALLATION OF ACCESSORIES

Before the radio is ready for use we need to attach the battery pack, as well as charge the battery.

3.1 Installing/ Removing the Antenna

- a. Installing the Antenna: Screw the antenna into the connector on the top of the transceiver by holding the antenna at its base and turning it clockwise until secure.
- b. Removing the Antenna: Turn the antenna counter-clockwise to remove it.

3.2 Installing the belt clip

- a. To install the BELT CLIP, slide the clip down into the slot on the back of the radio until the BELT CLIP LATCH clicks.
- b. To remove the BELT CLIP, press the LOCK TAB down, and then gently pull the belt clip up toward the top of the radio.

3.3 Installing the battery pack

Before attaching or removing the battery make sure your radio is turned off by turning the power/volume knob all the way counter-clockwise.

To install the battery pack:

- a. With the back of the radio facing you, insert the bottom part of the Li-ion battery pack to the bottom of the radio.
- b. Push down the Li-ion battery pack into the radio until the Battery Lock Tab locks into place.

To remove the battery pack:

- a. Press the Battery Lock Tab downward until the Li-ion battery pack unlocks from the radio.
- b. Pull the Li-ion battery pack away from the radio.



3.4 Installing the Additional Speaker/Microphone (Optional)

Pry open the rubber MIC-Headset jack cover and then insert the Speaker / Microphone plug into the double jack.

4. RADIO OVERVIEW

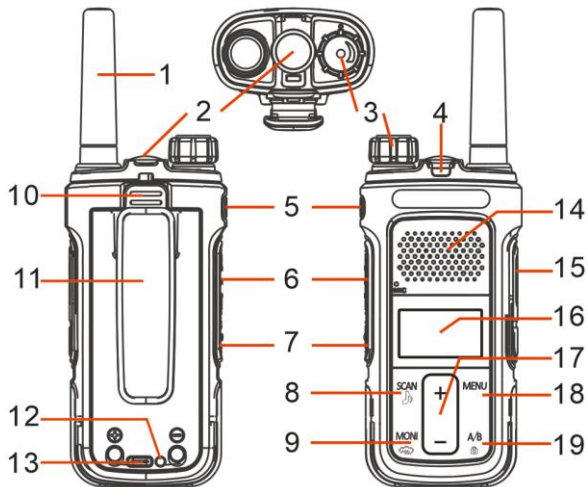
4.1 Main controls and parts of the radio



1.	Antenna
2.	LED Flashlight
3.	Power Switch/ Volume control
4.	Led: transmission (red) / reception (green)
5.	[LAMP]: Press the key once to turn on the flashlight, Press and hold the key again to flash the flashlight, and press the hand again to turn off the flashlight; Press and hold the key to turn on the audible and visual alarm function
6.	[PTT]:Transmit key, hold the key to speak, release the key after speaking, and receive incoming calls;
7.	FM: Press to turn on the radio function, and press again to turn off the radio function;
8.	[SCAN ]: Press to send a CALL ALERT signal; Press and hold to enter SCAN mode.
9.	[MON ]: Press to enter weather forecast mode; Press and hold to enter MONITOR mode.
10.	Battery release latch
11.	Belt clip
12.	Charging indicator: The red light is always on during charging, and the green light is always on when charging is full.
13.	Micro-USB Charging Port: DC5V USB input
14.	Speaker
15.	External Speaker/Microphone Jack: allows the connection with external devices such as headsets, microphones.
16.	LCD Display
17.	+/- keys: push to select functions or Menu. Channel mode, press + to switch up the channel; press - to switch channel down.
18.	Menu: press to enter the Menu functions and to confirm your selections.
19.	[A/B ] In standby mode, press this key to switch between main/sub channels between A/B channels. Press and hold this key to lock or unlock the keyboard. Menu mode, Press the key to exit the menu; Press to enter SCAN mode. Press and hold to turn KEY LOCK on/off.

4.2 LCD Display

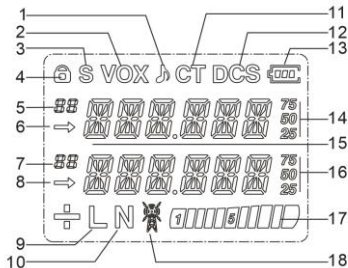

1. Call Tone (Off, 1–10)	10. Narrowband indicator (working at 12.5KHz)
2. VOX(OFF,1-5)	11.CTC Indicator(67.0-254.1)
3. Dual Channel Monitor(ON/OFF)	12.DCS Indicator(D023I/N-D754I/N)
4. Keypad Lock	13. Battery Indicator (3 Battery Levels)
5. A Channel number (1-22) or menu number (1-17)	14. The last two digits of RX/TX frequency (4-5 digits after the decimal point)
6. A Channel arrow pointer	15. Frequency/channel alias display area
7.B Channel number (1-22)	16. The last two digits of RX/TX frequency (4-5 digits after the decimal point)
8. B Channel arrow pointer	17. Transmit power indicator (half grid for low power, full grid for high power)
9. Low power indication	18. Status (Transmit/ Receive)

5. BASIC OPERATIONS

5.1 Turning your Radio On and Off

To turn your radio **ON**, turn the rotary knob clockwise.

To turn your radio **OFF**, turn the rotary knob counterclockwise.

5.2 Setting the Volume

Increase volume by turning the rotary knob clockwise.

To decrease volume, turn the rotary knob counterclockwise.

Do not hold the radio close to your ear. If the volume is set to an uncomfortable level, it could hurt your ear.

5.3 Choosing a Channel

Your radio has 30 channels and 260 Privacy codes you can use to talk to others. In order to speak to someone, both your radios must be set to the same channel and Privacy code.

Press **[+/UP]** to move up one channel at a time. Press and hold the key to scroll quickly up the channels.

Press **[-/DOWN]** to move down one channel at a time. Press and hold the key to scroll quickly down the channels.

5.4 Talking and Listening

All radios in your group must be set to the same channel and Sub-Code in order to communicate.

1. Hold your radio 2–3 cm from your mouth.
2. Press and hold the **[PTT]** key while speaking. The Transmit **TX ---** icon appears on the display.
3. Release the **[PTT]** key. You can now receive incoming calls. When you do, the Receive **RX ---** icon appears on the display.

For maximum clarity, hold the radio 2 to 3 cm away and avoid covering the microphone while talking.

5.5 SCAN

Your G11S can scan all 30 channels for activity. Pressing and holding **[SCAN]** key for 2 seconds to enter. Repeat the same procedure to exit.

Your radio will rapidly scan each of the 30 channels and stop on any active channel. Your radio will resume scanning after 4

seconds when the channel is no longer active.

When you press the **[PTT]** key to transmit on an active channel, the scanning function will stop and remain on the active channel for 5 seconds before resuming scan when **[PTT]** key is no longer pressed.

To resume scanning, quickly press the key.

5.6 Monitor

Press and hold the **[MONI]** key for around 2 second will let you hear noise so you can adjust the volume level of the radio when not receiving a signal. This should be used to check activity on your current channel before transmitting.

Press and hold the **[MONI]** key for 3 second again to get out of Monitor mode.

5.7 Keypad lock

This function locks the keypad to prevent accidental pressure of the controls.

To avoid accidentally changing the radio setting, press the **[A/B]** key for 2 seconds. The  icon will appear on the display. **PTT, LAMP, MONITOR, and FM Radio** keys will still be active. Repeat the same procedure to unlock the keypad.

5.8 A/B switch

Press the **[A/B]** switch to select the master frequency.

5.9 Flashlight and Emergency Alert

This function is very useful for night illumination.

To turn it on press **[LAMP]**; push it again, the flash light will be strobe; push it again: it will turn off.

Open radio, press and hold the **[LAMP]** key for about 2 seconds to activate the sound and light alarm function. Press **[LAMP]** key again to exit the alarm state.

5.10 FM Radio (FM)

The frequency range to listen to the radio is 78-108MHz.

With G11S turned on, Press **[FM]** to turn on the radio. Select the desired radio frequency with the **[+UP]/[-DOWN]** keys. Press **[FM]** to exit FM radio.

Note: while you are listening to the radio, the channel of A / B receiving signal will automatically



switch to the channel mode for normal transmitting and receiving.

When the signal disappears the radio will automatically switch again to FM radio mode.

5.11 NOAA Weather Radio

Your radio can receive weather broadcasts from the NOAA National Weather Service.

While using the Weather Radio, you are not able to receive GMRS communications.

1> To turn on the Weather Radio Broadcast mode, press [MONI ]. WEATHE appears.

2> Press [+UP]/[-DOWN] to select the desired number of weather channels.

3> To exit the Weather Radio Broadcast mode, press [MONI ]. WEATHE disappears.

NOTE: There are 11 NOAA channel frequencies available and these frequencies are common between the US and Canada. You need to know what frequency is being transmitted in your location.

NOAA Weather Radio Frequency List:

Chan.	Freq. (MHz)	Chan.	Freq. (MHz)
WEATHER 1	162.550	WEATHER 7	162.525
WEATHER 2	162.400	WEATHER 8	161.650
WEATHER 3	162.475	WEATHER 9	161.775
WEATHER 4	162.425	WEATHER10	161.750
WEATHER 5	162.450	WEATHER11	162.000
WEATHER 6	162.500	---	---

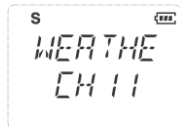

5.12 1000Hz, 1450Hz, 1750Hz Tone-burst

To send out a tone-burst; you simultaneously will press a key while holding down the PTT. No further configuration required using this feature.

The following configurations will transmit accordingly:

- [PTT] +[-DOWN] = Transmits 1450Hz Tone Burst
- [PTT] +[+UP] = Transmits 1750Hz Tone Burst
- [PTT] +[MENU] = Transmits 2100Hz Tone Burst

If you have the keypad lock enabled on your radio, you can still send a 1750Hz tone the regular way without having to unlock your radio.

6. WORKING THE MENU SYSTEM

6.1 Basic use

Using the menu with arrow keys

1> Press the **[MENU]** key to enter the menu.

2> Use the **[+UP]** and **[-DOWN]** keys to navigate between menu items.

3>Once you find the desired menu item, press **[MENU]** again to select that menu item.

4>Use the **[+UP]** and **[-DOWN]** keys to select the desired parameter.





5>When you've selected the parameter you want to set for a given menu item;





a). To confirm your selection, press **[MENU]** and it will save your setting and bring you back to the main menu.



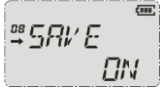

b). To cancel your changes, press **[A/B]** and it will reset that menu item and bring you out of the menu entirely.

6> To exit out of the menu at any time, press the **[A/B]** key.

6.2 Shortcut Menu operations

MENU No.	Name (Full Name)	LCD display	Selectable
1	RXCODE -Receiver Privacy Codes		OFF;67.0...D754N The Privacy Codes is off, and the display is OFF. When the display is OFF, press +key to select CTCSS with priority; When the display is OFF, press - key to select DCS with priority.
2	TXCODE -Transmitter Privacy Codes		OFF;67.0...D754N The Privacy Codes is off, and the display is OFF. When the display is OFF, press +key to select CTCSS with priority; When the display is OFF, press - key to select DCS with priority.
3	SQL - Squelch Level		.0-9 Levels .0:Lowest .9:Highest
4	LIGHT -Back Light		.OFF .ON .KEY

5	BEEP - Keypad Beep		.OFF .ON *Allows audible confirmation of a key press.
6	VOX - VOX		.OFF will turn off VOX function. .1:Lowest Sensitivity .5:Highest Sensitivity
7	TDR – Dual Watch Operation		OFF ON *Monitor [A] and [B] at the same time. Activate the dual watch, and the screen will display the 'S' icon.
8	SAVE - Battery Saving		OFF: ON:
9	TOT - Time-Out-Timer		OFF,30,60...180S *This feature provides a safety switch that limits transmission time to a programmed value. This will promote battery conservation by not allowing you to make excessively long transmissions, and in the event of a stuck PTT switch it can prevent interference to other users as well as battery depletion

10	BCLO -Busy Channel Lock-out		OFF ON *Disables the[PTT] key on a channel that is already in use. The transceiver will sound a beep tone and will not transmit if the[PTT] key is pressed when a channel is already in use.
11	RING -Call Tone Select		.OFF- close call tone; .Select 1-10 process, you can listen to the call tone.
12	VOICE -Voice Reminding		.OFF - turn off voice prompts; .CHI- voice prompt is Chinese; .ENG- voice prompts in English. *Allows audible voice confirmation of a key press.
13	RESET -Restore defaults		*Resets the radio to factory defaults.
14	W/N -Wide/Narrow Bandwidth		.Wide is 25KHz .Narrow is 12.5KHz. NOTE: On channels 8-14, this function cannot be modified.

6.3 Menu settings

6.3.1 Receiving with Privacy Codes (RXCODE) - MENU 01

You can configure different Receiving Privacy Codes for each channel. The selected Privacy Code may be different for each channel.

Note: Selecting a Privacy Code of "OFF" will disable the Privacy feature. To communicate between two G11S radios, all radios in your group must be set to the same channel and Privacy Code selections.

The Receiving Privacy Codes setting steps are as follows:

1> Press **[MENU]** key to enter the main menu, and press **[+UP]/[-DOWN]** key to enter the MENU 01.

2> Press **[MENU]** key again to enter the **RXCODE** menu;

3> Press **[+UP]/[-DOWN]** key to select the Privacy Code, and the selection range is OFF / 67.0~754N.

Note: The state of the Privacy Code is off, and the display is OFF. When the display is OFF, press the [+UP] key to select CTCSS with priority, range 67~254.1Hz (50 groups in total); when the display is OFF, press the [-DOWN] key to select DCS with priority, range D754I-023N (104 groups in total).

During the selection process, Pressing and holding the [+UP]/[-DOWN] key to quickly search for the sub-tone code.

4> Press **[MENU]** key to confirm;

5> Press **[PTT]** or **[A/B]** key to exit the menu mode.

6.3.2 Transmitting with Privacy Codes (TXCODE) --- MENU 02

You can configure different transmission Privacy Codes for each channel. The selected Privacy Code may be different for each channel.

Note: Selecting a Privacy Code of "OFF" will disable the Privacy feature. To communicate between two G11S radios, all radios in your group must be set to the same channel and Privacy Code selections.

The transmission Privacy Codes setting steps are as follows:

1> Press **[MENU]** key to enter the main menu, and press **[+UP]/[-DOWN]** key to enter the MENU 02.

2> Press **[MENU]** key again to enter the **TXCODE** menu;

3> Press **[+UP]/[-DOWN]** key to select the Privacy Code, and the selection range is OFF / 67.0~754N.

Note: The state of the Privacy Code is off, and the display is OFF. When the display is OFF, press the [+UP] key to select CTCSS with priority, range 67~254.1Hz (50 groups in total); when the display is OFF, press the [-DOWN] key to select DCS with priority, range D754I-023N (104 groups in total).

During the selection process, Pressing and holding the [+UP] / [-DOWN] key to quickly search for the sub-tone code.

4> Press [MENU] key to confirm;

5> Press [PTT] or [A/B] key to exit the menu mode.

6.3.3 Squelch level (SQL) - MENU 03

This function turns on the Squelch when the signal is strong; the Squelch will stay off when the signal is weak. Set the same DCS codes of your group and turn on the squelch.

By setting the level too high, you may not receive the weak signals; while by setting it too low you may receive noises or undesired signals.

NOTE: This transceiver has 10 (0-9) available levels: 0 means that the Squelch is turned on. From level 1 to level 9 you will have different levels of noises reduction.

The higher is the level, the louder will be the Squelch.

The steps for setting the squelch level are as follows:

1> Press [MENU] key to enter the main menu, and press [+UP]/[-DOWN] key to enter the MENU 03.

2> Press [MENU] key again to enter the SQL menu;

3> Press [+UP]/[-DOWN] key to select the squelch level, select the range 0, 1-9

4> Press [MENU] key to confirm;

5> Press [PTT] or [A/B] key to exit the menu mode.

6.3.4 Backlight intensity (LIGHT) - MENU 04

The LCD backlight is convenient for you to use at night or in a dark environment. The LCD backlight setting steps are as follows:

1> Press [MENU] key to enter the main menu, and press [+UP]/[-DOWN] key to enter the MENU 04.

2> Press [MENU] key again to enter the LIGHT menu;

3> Press [+UP]/[-DOWN] key to select the LCD backlight switch, and the selection range is ON/OFF/KEY;

Note: ON-backlight will be always on; OFF-backlight will be always off; KEY-touch key will automatically activate the backlight. Without any key operation, the backlight will be automatically turned off after a delay of 5 seconds.

4> Press [MENU] key to confirm;

5> Press [PTT] or [A/B] key to exit the menu mode.

6.3.5 Beep tone (BEEP) - MENU 05

If you enable this function, every time a key is pressed, you will hear a Beep tone. You can set it as follows:

1> Press [MENU] key to enter the main menu, and press the [+UP]/[-DOWN] key to enter the MENU 05.

2> Press [MENU] key again to enter the BEEP menu;

3> Press [+UP]/[-DOWN] key to select the BEEP switch, and the selection range is ON/OFF;

Note: ON-turn on the key prompt sound; OFF-turn off the key prompt sound.

4> Press [MENU] key to confirm;

5> Press [PTT] or [A/B] key to exit the menu mode.

6.3.6 VOX (VOX) - MENU 06

Your radio has 5 VOX level settings: (OFF/1~5).

This function allows hands-free conversations: just speak in the direction of the microphone and the communication will be automatically activated.

The steps for setting up VOX voice control transmission are as follows:

1> Press [MENU] key to enter the main menu, and press the [+UP]/[-DOWN] key to enter the MENU 06.

2> Press [MENU] key again to enter the VOX menu;

3> Press [+UP]/[-DOWN] key to select the VOX switch and sensitivity, the selection range is OFF, 1~5;

Note: Level 5 low sensitivity, use under high background noise; Level 1 high sensitivity, use under low background noise.

Select 'OFF' will turn off the VOX function. After the VOX function is turned on, the screen will display the 'VOX' icon.

4> Press [MENU] key to confirm;

5> Press [PTT] or [A/B] key to exit the menu mode.

6.3.7 Dual Watch function (TDR) - Menu 07

This function is a dual-channel monitor scan, which can monitor the A and B segments in the normal mode. If a signal is received on the monitoring channel, the scan stays on this channel. The steps for setting the dual-frequency waiting function are as follows:

- 1> Press **[MENU]** key to enter the main menu, press **[+UP]/[-DOWN]** key to enter the MENU 07.
- 2> Press **[MENU]** key again to enter the TDR menu;
- 3> Press **[+UP]/[-DOWN]** key to select the dual-frequency wait switch, and the selection range is ON/OFF;

Note: OFF-turn off the dual watch function; ON-turn on the dual watch function.

Turn on the dual watch function; the screen will display the 'S' icon.

- 4> Press **[MENU]** key to confirm;
- 5> Press **[PTT]** or **[A/B]** key to exit the menu mode.

6.3.8 Power save (SAVE) - MENU 08

To save battery power, this function can turn off the transceiver when no signal is received.

- 1> Press **[MENU]** key to enter the main menu, press **[+UP]/[-DOWN]** key to enter the MENU 08.
- 2> Press **[MENU]** key again to enter the SAVE menu;
- 3> Press **[+UP]/[-DOWN]** key to select the power saving mode, and the selection range is ON/OFF;

Note: ON-turn on the power saving mode; OFF-turn off the power saving mode.

- 4> Press **[MENU]** key to confirm;
- 5> Press **[PTT]** or **[A/B]** key to exit the menu and return to normal operation mode.

6.3.9 Time out Timer (TOT) - MENU 09

The TOT function is used to prevent a too long transmission. This function temporarily blocks transmissions if the radio has been used beyond the maximum time permitted. Once reached the preset timer, the radio will be forced in reception mode. The transmission time can be set in 6 levels with 30 seconds each (between 30 and 180 seconds). The setting steps are as follows:

- 1> Press **[MENU]** key to enter the main menu, press **[+UP]/[-DOWN]** key to enter the MENU 09.

- 2> Press **[MENU]** key again to enter the **TOT** menu;
- 3> Press **[+UP] / [-DOWN]** key to select the transmission time limit, the selection range is OFF/30S/60S/90S/120S/150S/180S;
- 4> Press **[MENU]** key to confirm;
- 5> Press **[PTT]** or **[A/B]** key to exit the menu mode.

6.3.10 Busy channel lockout (BCLO) - MENU 10

When this function is active, if you select a busy channel and press the PTT, the transceiver will not transmit.

- 1> Press **[MENU]** key to enter the main menu, press the **[+UP]/[-DOWN]** key to enter the MENU 10.
- 2> Press **[MENU]** key again to enter the **BCLO** menu;
- 3> Press **[+UP]/[-DOWN]** key to select the switch and select the range ON/OFF;
- 4> Press **[MENU]** key to confirm;
- 5> Press **[PTT]** or **[A/B]** key to exit the menu mode.

6.3.11 Call Tone Select (RING)- MENU 11

This setting will allow you to transmit a unique Call Tone alert to identify your radio when you transmit messages. You can select from one of 10 different Call Tone signals. To Set Call Tone:

- 1> Press **[MENU]** key to enter the main menu, press **[+UP]/[-DOWN]** key to enter the MENU 11.
- 2> Press **[MENU]** key again to enter the **RING** menu;
- 3> Press the **[+UP]/[-DOWN]** key to select a different Call Tone. An example of each call tone will sound for 1.5 seconds.

Note: OFF-turn off the call reminder tone; during the selection of 1-10, you can listen to the call tone.

Before you initiate a voice intercom, you can press the [CALL] key to remind the call.

- 4> Press **[MENU]** again to confirm;
- 5> Press **[PTT]** or **[A/B]** key to exit the menu and return to normal operation mode.

6.3.12 VOICE Selection (VOICE) - MENU 12

Your G11S radio has voice prompt function for channel and function operation, you can choose to switch voice function or prompt language type. The setting steps are as follows:

- 1> Press **[MENU]** key to enter the main menu, and press **[+UP]/[-DOWN]** key to enter the MENU 12.

2> Press [MENU] key again to enter the **VOICE** menu;

3> Press [+UP]/[-DOWN] key to OFF or Chinese and English selection, the selection range is OFF/CHI/ENG

Note: OFF-turn off the voice prompts function; CHI-prompt voice is Chinese; ENG-prompt voice is English.

After turning off the voice prompt function, there will be a beep prompt when you select a channel or menu setting.

4> Press [MENU] key to confirm;

5> Press [PTT] or [A/B] key to exit the menu mode.

6.3.13 Restore factory settings (RESET)-MENU 13

Your G11S radio has a reset function. To reset the radio, proceed as follows:

1>Press [MENU] key to enter the main menu, and press [+UP]/[-DOWN] key to enter the **MENU 13**, the screen displays **RESET**.

2> Press [MENU] key to confirm, and the radio resets the parameters.

6.3.14 Wide/Narrow bandwidth (WN) - MENU 14

This function is used to set the working bandwidth of the radio. You can choose between wide or narrow bandwidth.

To set the working bandwidth of the radio, proceed as follows:

1>Press [MENU] key to enter the main menu, and press [+UP]/[-DOWN] key to enter the MENU 14, the screen displays 14 W/N.

2> Press [MENU] key again to enter the W/N menu;

3> Press [+UP]/[-DOWN] key to select the Wide or Narrow bandwidth;

4> Press [MENU] key to confirm;

5> Press [PTT] or [A/B] key to exit the menu mode.

Note: The broadband is 25KHz, and the narrowband is 12.5KHz. On channels 8-14, this function cannot be modified.

Appendix A. – Trouble shooting guide

Phenomena	Analysis	Solution
You cannot turn on the radio.	The battery may be installed improperly.	Remove and reattach the battery.
	The battery power may run out.	Recharge or replace the battery.
	The battery may suffer from poor contact caused by dirty or damaged battery contacts.	Clean the battery contacts or replace the battery.
During receiving, the voice is weak or intermittent.	The battery voltage maybe low.	Recharge or replace the battery.
	The volume level may be low.	Increase the volume.
	The antenna maybe loose or maybe installed incorrectly.	Turnoff the radio, and then remove and reattach the antenna.
	The speaker maybe blocked.	Clean the surface of the speaker.
You cannot communicate with other group members.	The frequency or signaling type maybe inconsistent with that of other members.	Verify that your TX/RX frequency and signaling type are correct.
	You may be too far away from other members.	Move towards other members.
You hear unknown voices or noise.	You may be interrupted by radios using the same frequency.	Change the frequency, or adjust the squelch level.
	The radio in analog mode maybe set with no signaling.	Request your dealer to set signaling for the current channel to avoid interference
You are unable to hear anyone because of too much noise and hiss.	You may be too far away from other members.	Move towards other members.
	You may be in an unfavorable position. For example, your communication may be blocked by high buildings or blocked in an underground area.	Move to an open and flat area, restart the radio, and try again.
	It may be the result of external disturbance (such as electromagnetic interference).	Stay away from equipment that may cause interference.
The radio keeps transmitting.	VOX may be turned on or the headset is not installed in place	Turn off the VOX function. Check that the headphones are in place.

Appendix B. - Technical Specifications

General

Frequency Range	GMRS (RX & TX) 136.0-174.0 & 400.0-512.0MHz (Scanning Receiver)
Memory Channel	30 GMRS Channels + 11 NOAA Weather
Operation Voltage	DC7.4V \pm 10%
Battery Capacity	1500mAH (Li-Ion)
Frequency Stability	\pm 2.5ppm
Operating Temperature	-20°C to +60°C
Mode of Operation	Simplex
Antenna Impedance	50ohm

Transmitter Part

FM Modulation	11K0F3E@12.5KHz
Adjacent Channel Power	60dB @ 12.5 KHz
Transmission current	\leq 600mA

Receiver Part

Receive Sensitivity	0.25 μ V (12dB SINAD)
Adjacent Channel Selectivity	\geq 55dB@12.5KHz
Inter Modulation and Rejection	\geq 55dB@12.5KHz
Conducted Spurious Emission	\leq -57dB@12.5KHz
Rated Audio Power Output	1W @16ohms
Receive current	\leq 350mA
Rated Audio Distortion	\leq 5%

NOTE: All specifications may be modified without prior notice or liability. Thank you.

Appendix C. - GMRS Frequency Chart (MHz)

CH.No	CH.Freq.	Power Output	CH.No	CH.Freq.	Power Output
1	462.5625	High	16	462.5750	High
2	462.5875	High	17	462.6000	High
3	462.6125	High	18	462.6250	High
4	462.6375	High	19	462.6500	High
5	462.6625	High	20	462.6750	High
6	462.6875	High	21	462.7000	High
7	462.7125	High	22	462.7250	High
8	467.5625	Low	23	462.5500(RX)/467.5500(TX)	High
9	467.5875	Low	24	462.5750(RX)/467.5750(TX)	High
10	467.6125	Low	25	462.6000(RX)/467.6000(TX)	High
11	467.6375	Low	26	462.6250(RX)/467.6250(TX)	High
12	467.6625	Low	27	462.6500(RX)/467.6500(TX)	High
13	467.6875	Low	28	462.6750(RX)/467.6750(TX)	High
14	467.7125	Low	29	462.7000(RX)/467.7000(TX)	High
15	462.5500	High	30	462.7250(RX)/467.7250(TX)	High

Disclaimer

The Company endeavors to achieve the accuracy and completeness of this manual, but no warranty of accuracy or reliability is given. All the specifications and designs are subject to change without notice due to continuous technological development. No part of this manual may be copied, modified, translated, or distributed in any manner without the prior written consent of the Company.

We do not guarantee, for any particular purpose, the accuracy, validity, timeliness, legitimacy or completeness of the third-party products and contents involved in this manual.

BAOFENG

FIND TUTORIALS, SUPPORT AND MORE

www.baofengradio.com

 <https://www.facebook.com/BaofengOfficial>



FC CE 06780  **ROHS**

Print version: G11S_GMRS_ V1