

BAOFENG

GMRS Two Way Radio

UV-9G

User Manual

PREFACE

Congratulations on your purchase of a high quality BAOFENG product. Your two-way radio represents the state-of-the-art in high-tech engineering. Designed for GMRS (General Mobile Radio Service) operation, this compact package is big in performance. It is a quality piece of electronic equipment, skillfully constructed with the finest components. The circuitry is all solid-state and mounted on a rugged printed circuit board. This easy-to-use radio will deliver you secure, instant and reliable communications at peak efficiency. Please read this manual carefully before use. The information presented herein will help you to derive maximum performance from your radio.



WARNING: MODIFICATION OF THIS DEVICE TO RECEIVE CELLULAR RADIOTELEPHONE SERVICE SIGNALS IS PROHIBITED UNDER FCC RULES AND FEDERAL LAW.



FCC Part 15.21 Warning Statement

NOTE: THE GRANTEE IS NOT RESPONSIBLE FOR ANY CHANGES OR MODIFICATIONS NOT EXPRESSLY APPROVED BY THE PARTY RESPONSIBLE FOR COMPLIANCE. SUCH MODIFICATIONS COULD VOID THE USER'S AUTHORITY TO OPERATE THE EQUIPMENT.



ATTENTION! Before using this product, read the RF Energy Exposure and Product Safety Guide that ship with the radio which contains instructions for safe usage and RF energy awareness and control for compliance with applicable standards and regulation.

Table of Contents

Chapter1. Getting Started			
1.1 Regulations and Safety Warnings	01	5.3 Making a call	17
1.2 Main features	05	5.4 Channel selection	18
1.3 Content of the packaging	05	5.5 Frequency (VFO) mode	18
Chapter2. Charging the Battery		5.6 Channel (MR) mode	18
2.1 Charging the Battery Pack	06	Chapter6. Advanced Features	
2.2 Charger Supplied	06	6.1 Frequency scanning	19
2.3 Use Caution with the Li-ion Battery	06	6.2 Channel scanning	19
2.4 How to Charge	07	6.3 Search CTCSS/DCS Code	19
2.5 LED Indicator	07	6.4 Cursor ▼ ▲ Conversion (A/B)	20
2.6 How to Store the Battery	08	6.5 Keypad lock	20
Chapter3. Installation of Accessories		6.6 FM Radio (FM)	20
3.1 Installing / Removing the Antenna	08	6.7 Flashlight	21
3.2 Installing the belt clip	08	6.8 TX 1000Hz, 1450Hz, 1750Hz Tone-burst	21
3.3 Installing the battery pack	09	6.9 Manual Programming (Channels Memory)	21
3.4 Additional Speaker/Microphone (Optional)	10	Chapter7. Working the MENU System	
Chapter4. Radio Overview		7.1 Basic use	23
4.1 Buttons and controls of the radio	11	7.2 Using short-cuts	23
4.2 Display of the radio	13	7.3 Functions and operations	24
4.3 Status Indications	14	Appendix A. - Technical Specifications	32
4.4 Main keypad controls	14	Appendix B. - Trouble shooting guide	33
Chapter5. Basic Operations		Appendix C. - Shortcut Menu operations	34
5.1 Power on the radio	17	Appendix D. - GMRS Frequency Chart (MHz)	41
5.2 Adjusting the volume	17	Appendix E. - Weather Channel Assignments	41

Chapter 1. Getting Started

1.1 Regulations and Safety Warnings

IMPORTANT NOTICE: FCC LICENSE REQUIRED

This two-way radio operates on GMRS (General Mobile Radio Service) frequencies which require an FCC (Federal Communications Commission) license. A user must be licensed prior to operating on Channels 1 through 7 on high power or 15 through 22, which comprise the GMRS channels of this radio. Serious penalties could result for unlicensed use of GMRS channels, in violation of FCC rules. Operation of this radio is subject to additional rules specified in 47 C.F.R. Part 95. Licensed users will be issued a call sign by the FCC, which should be used for station identification when operating this radio. GMRS users should also cooperate by engaging in permissible transmissions only, avoiding channel interference with other GMRS users, and being prudent with the length of their transmission time.

For licensing information and application forms, please call the FCC Hotline at 800-418-FORM. Request form #159 and form #605. Questions regarding the license application should be directed to the FCC at 888-CALLFCC. Additional information is available on the FCC's website at www.fcc.gov.

WARNING: Changes or modifications to this unit not expressly approved by the party responsible for compliance could void the user's authority to operate the equipment."

NOTE: This equipment has been tested and found to comply with the limits for a Class B digital device, pursuant to Part 15 of the FCC Rules. These limits are designed to provide reasonable protection against harmful interference in a residential installation. This equipment generates, uses and can radiate radio frequency energy and, if not installed and used in accordance with the instructions, may cause harmful interference to radio communications.

However, there is no guarantee that interference will not occur in a particular installation. If this equipment does cause harmful interference to radio or television reception, which can be determined by turning the equipment off and on, the user is encouraged to try to correct the interference by one or more of the following measures:

- Reorient or relocate the receiving antenna.

- Increase the separation between the equipment and receiver.
- Connect the equipment into an outlet on a circuit different from that to which the receiver is connected.
- Consult the dealer or an experienced radio/TV technician for help.

RF Exposure Compliance and Control Guidelines and Operating Instructions

To control your exposure and ensure compliance with the occupational/ controlled environmental exposure limits, always adhere to the following procedures.

Guidelines:

- Do not remove the RF Exposure Label from the device.
- User awareness instructions should accompany device when transferred to other users.
- Do not use this device if the operational requirements described herein are not met.

Operating Instructions:

- Transmit no more than the rated duty factor of 50% of the time. To transmit (talk), press the Push-to-Talk (PTT) key. To receive calls, release the [PTT] key. Transmitting 50% of the time, or less, is important because the radio generates measurable RF energy only when transmitting (in terms of measuring for standards compliance).
- Keep the radio unit at least 2.5cm away from the face. Keeping the radio at the proper distance is important as RF exposure decreases with distance from the antenna. The antenna should be kept away from the face and eyes.
- When worn on the body, always place the radio in an approved holder, holster, case, or body harness or by use of the correct clip for this product. Use of non-approved accessories may result in exposure levels which exceed the FCC's occupational/ controlled environmental RF exposure limits.
- Use of non-approved antennas, batteries, and accessories causes the radio to exceed the FCC RF exposure guidelines.
- Contact your local dealer for the product's optional accessories.

■ Precautions for Portable Terminals

Operating Prohibitions

To protect you against any property loss, bodily injury or even death, be sure to observe the following safety instructions:

1. Do not operate the product in a location containing fuels, chemicals, explosive atmospheres and other flammable or explosive materials. In such location, only an approved Ex-protection model is allowed for use, but any attempt to assemble or disassemble it is strictly prohibited.
2. Do not operate the product near or in any blasting area.
3. Do not operate the product near any medical or electronic equipment that is vulnerable to RF signals.
4. Do not hold the product while driving.
5. Do not operate the product in any area where use of wireless communication equipment is completely prohibited.

Important Tips

To help you make better use of the product, be sure to observe the following instructions:

1. Do not use any unauthorized or damaged accessory.
2. Keep the product at least 2.5 centimeters away from your body during transmission.
3. Do not keep the product receiving at high volume for a long time.
4. For vehicles with an air bag, do not place the product in the area over the air bag or in the air bag deployment area.
5. Keep the product and its accessories out of reach of children and pets.
6. Please operate the product within the specified temperature range.
7. Continuous transmission for a long time may lead to heat accumulation within the product. In this case, please keep it at a proper location for cooling.
8. Handle the product with care.
9. Do not disassemble, modify or repair the product and its accessories without authorization.

■ Precautions for Batteries

Charging Prohibitions

To protect you against any property loss, bodily injury or even death, be sure to observe the following safety instructions:

1. Do not charge or replace your battery in a location containing fuels, chemicals, explosive atmospheres and other

flammable or explosive materials.

2. Do not charge your battery that is wet. Please dry it with a soft and clean cloth prior to charge.
3. Do not charge your battery suffering deformation, leakage and overheat.
4. Do not charge your battery with an unauthorized charger.
5. Do not charge your battery in a location where strong radiation is present.
6. Overcharge shall always be prohibited for it may shorten the life of your battery.

Maintenance Instructions

To help your battery work normally or prolong its life, be sure to observe the following instructions:

1. Accumulated dust on charging connector may affect normal charging. Please use a clean and dry cloth to wipe it on a regular basis.
2. It is recommended to charge the battery under 5°C~40°C. Violation of the said limit may cause battery life reduction or even battery leakage.
3. To charge a battery attached to the product, turn it off to ensure a full charge.
4. Do not remove the battery or unplug the power cord during charging to ensure a smooth charging process.
5. Do not dispose of the battery in fire.
6. Do not expose the battery to direct sunlight for a long time nor place it close to other heating sources.
7. Do not squeeze and penetrate the battery, nor remove its housing.

Transportation Instructions

1. Damaged batteries must not be transported.
2. To avoid short circuit, separate the battery from metal parts or from each other if two or more batteries are transported in one packaging.
3. The radio must be switched off and secured against switch-on, if the battery is attached.

The content of the shipment must be declared in the shipping documents and by a Battery Shipping Label on the packaging. Contact your hauler for the local regulations and further information.

1.2 Main features

- Dual band (VHF/UHF) displayed
- 22 Modifiable GMRS Two-Way Channels (RX &TX)
- 87 Programmable Scanner Channels (Receive Only)
- Output power: 5W/0.5W (GMRS)
- 155 Privacy Codes (50 CTCSS codes/ 105 DCS codes)
- SOS Emergency function
- Built-in FM Radio (88-108MHz)
- 328 Motorola accessory jack
- TOT (Time out timer)
- Reverse function
- Busy Channel Lockout function (BCL)
- Frequency step: 2.5/5/6.25/10/12.5/25KHz
- Repeater shift
- Power Save
- IP57 certified
- Comply with FCC two way radio related standards, FCC ID: 2AJGM-P52UV
- Operating modes: UHF/VHF, UHF/UHF, VHF/VHF
- 8 Modifiable GMRS Repeater Channels (RX & TX)
- 11 NOAA Weather Radio & Scan (Channels 117-127)
- CTCSS and DCS codes research
- 1750Hz tone for repeaters
- Tri-Color Adjustable Backlight
- VOX, Scan, Dual Watch functions
- Channel or frequency mode selection
- DTMF function
- Setting and storing of channel names
- VOICE: vocal indication of the function selected
- Frequency offset (adjustable): 0-69.990MHz
- Squelch adjustable in 9 levels
- Li-Ion 1800mAh battery pack

1.3 Content of the packaging

- 1 UV-9G transceiver with antenna
- 1 Fast desktop charger
- 1 Belt clip
- 1 Li-Ion battery pack
- 1 Wall adaptor

If any item is missing, please verify with your BAOFENG dealer.

Chapter2. Charging the Battery

2.1 Charging the Battery Pack

The Li-ion battery pack is not charged at the factory; please charge it before use. Charging the battery pack for the first time after purchase or extended storage (more than 2 months) may not bring the battery pack to its normal maximum operating capacity. Best operation will require fully charging/ discharging the battery two or three times before the operating capacity will reach its best performance. The battery pack life may be depleted when its operating time decreases even though it has been fully and correctly charged. If this is the case, replace the battery pack.

2.2 Charger Supplied

Please use the specified charger provided by BAOFENG. Other models may cause explosion and personal injury. After installing the battery pack, and if the radio displays low battery with a voice prompt, please charge the battery.

2.3 Use Caution with the Li-ion Battery

- a. Do not short the battery terminals or throw the battery into a fire. Never attempt to remove the casing from the battery pack, as BAOFENG cannot be held responsible for any accident caused by modifying the battery.
- b. The ambient temperature should be between 5°C-40°C (40°F - 105°F) while charging the battery. Charging outside this range may not fully charge the battery.
- c. Please turn off the radio before inserting it into the charger. It may otherwise interfere with correct charging.
- d. To avoid interfering with the charging cycle, please do not cut off the power or remove the battery during charging until the green light is on.
- e. Do not recharge the battery pack if it is fully charged. This may shorten the life of the battery pack or damage the battery pack.
- f. Do not charge the battery or the radio if it is damp. Dry it before charging to avoid damage.

WARNING !

When keys, ornamental chain or other electric metals contact the battery terminal, the battery may become damage or injure a human. If the battery terminals are short circuited it will generate a lot of heat. Take care when carrying and using the battery. Remember to put the battery or radio into an insulated container. Do not put it into a metal container.

2.4 How to Charge

- a. Plug the AC adaptor into the AC outlet, and then plug the cable of the AC adaptor into the DC jack located on the back of the charger. The indicator light blinks orange and is then ready to charge a battery.
- b. Plug the battery or the radio into the charger. Make sure the battery terminals are good in contact with charging terminals. The indicator light turns to red--- charging begins.
- c. It takes approximately 2-5 hours to fully charge the battery. When the lamp lights green, the charging is completed. Remove the battery or the radio unit with its battery from socket.

When charging a radio (with battery) the indicating lamp will not turn into green to show the fully charged status if the radio is powered on. Only when the radio is switched off will the lamp indicate normal operation. The radio consumes energy when it is power-on, and the charger cannot detect the correct battery voltage when the battery has been fully charged. So the charger will charge the battery in constant voltage mode and fail to indicate correctly when the battery has been fully charged.

2.5 LED Indicator

STATUS	LED
No Battery	Green and red alternately flashing
Charge Normally	Red
Fully Charged	Green
Trouble	Red blinks fast for a long time

NOTE: Trouble means battery too warm, battery short-circuited or charger short-circuited.

2.6 How to Store the Battery

- a. If the battery needs to be stored, keep it in status of 80% discharged.
- b. It should be kept in low temperature and dry environment.
- c. Keep it away from hot places and direct sunlight.
 - » Do not short circuit the battery terminals.
 - » Never attempt to remove the casing from the battery pack.
 - » Never store the battery in unsafe surroundings, as a short may cause an explosion.
 - » Do not put the battery in a hot environment or throw it into a fire, as it may cause an explosion.

Chapter3. Installation of Accessories

Before the radio is ready for use we need to attach the antenna and battery pack, as well as charge the battery.

3.1 Installing/ Removing the Antenna

- a. Installing the Antenna: Screw the antenna into the connector on the top of the transceiver by holding the antenna at its base and turning it clockwise until secure.
- b. Removing the Antenna: Turn the antenna counter-clockwise to remove it.

3.2 Installing the belt clip

- a. Install the fixing head: Install the random belt clip fixing head in the slot on the back of the two-way radio and tighten the screws.
- b. Insert the rotating belt clip: Slide the fixed head of the machine along the guide of the rotating back clip until you hear a "click" sound.
- c. Remove the belt clip: Use the key to press the disassembly engine upwards until it

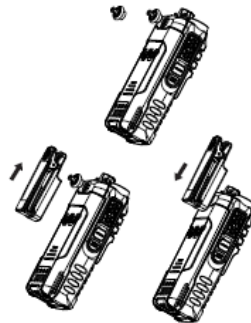

releases, and then push the belt clip with your thumb until the belt clip is removed.

3.3 Installing the battery pack

Before attaching or removing the battery make sure your radio is turned off by turning the power/volume knob all the way counter-clockwise.

Insert the two protrusions on the front of the battery into the notches on the bottom of the radio, and then press the tail of the battery toward the radio until you hear a "click".

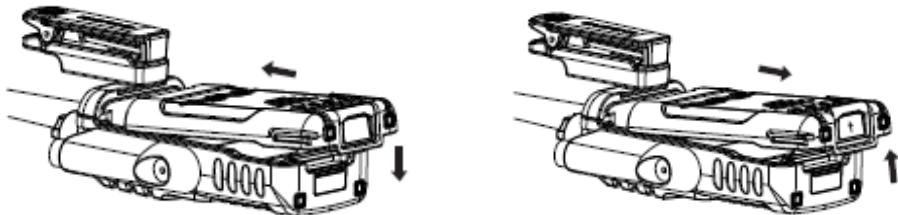

Remove the battery pack

Turn off the radio. Then lift the battery push button at the end of the battery in the direction indicated by the arrow to disengage the tail of the battery from the intercom and remove the battery backwards.

3.4 Installing the Additional Speaker/Microphone (Optional)

- a. Use a flat-blade screwdriver to unscrew the screw at the lower end of the cover counterclockwise to remove the headset cover.
- b. Insert the protruding part of the lower end of the headset into the slot indicated by the arrow in the figure below, and then align the nut on the upper end of the headset with the corresponding threaded hole of the transceiver and rotate it clockwise until it is tightened.

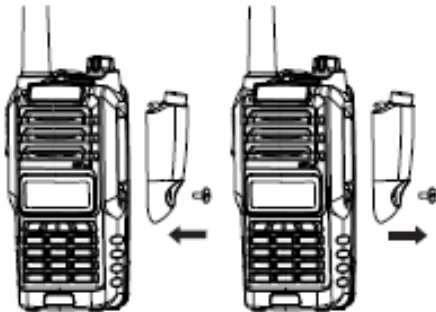

NOTE: Please install accessories correctly; otherwise the waterproof performance of this product may be affected.

Chapter4. Radio Overview

4.1 Buttons and controls of the radio

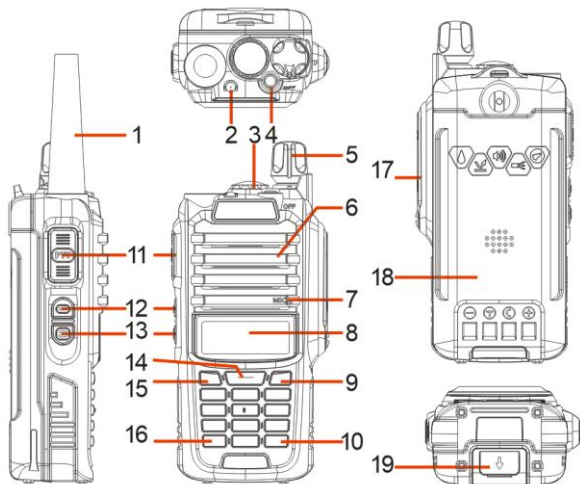

1. Antenna
2. Led: transmission (red) ; reception (green)
3. Flashlight
4. SOS: If you keep it pressed for 5 seconds you will hear an alarm note and the radio will switch to alarm mode
5. Power / Switch / Volume control: Rotate to switch on/off the radio and adjust the volume
6. Speaker
7. Microphone
8. LCD display
9. EXIT: press to exit the Menu and functions. A/B (appears on the display): push to select the desired frequency (VHF or UHF) in the main or secondary display
10. #**PTO**: Keypad lock. Long pressure: the keypad will be locked. Short pressure: high or low power selection
11. PTT
12. SK1: Press it activate the FM radio
13. SK2: Long press: to activate the Monitor function. Short press: turns the flashlight on. Press it again to issue an emergency light
14. ▲ / ▼ keys: to select the functions/menu
15. MENU: enter the MENU functions and confirms the selection. In the off state, press and hold this key to turn on the radio, allowing switching between frequency mode or channel mode
16. *SCAN: Reverse frequency/SCAN. Press to activate the Reverse frequency; keep it pressed to activate the SCAN function
17. MIC/SP: External speaker/mike jacks
18. 1800mAh Li-Ion battery pack
19. Battery release latch

4.2 LCD Display of the radio

LCD Display

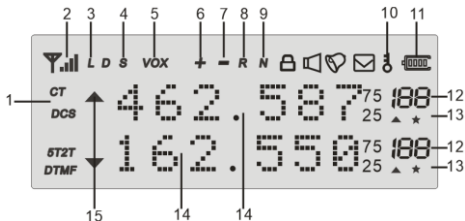

1. These symbols show that you set a **DCS** or **CTCSS** code in tx or rx. In tx mode it appears while you are transmitting, while in rx mode it is shown also in stand-by condition.
2. **Received signal strength.**
3. **Low power selection**
4. This letter is displayed when the **Dual Watch** function is active.
5. **VOX** function enabled.
6. Appears when a **positive shift** is activated.
7. Appears when a **negative shift** is enabled.
8. **Reverse** frequency
9. **Narrow bandwidth:** N = narrow. When the wide (W) bandwidth is activated, no icon is displayed.
10. This icon indicates the **keypad lock**. To unlock it press **[#TTO]**.

11. **Battery level indicator.** When the battery is almost used up, the icon starts blinking and the transmission is blocked. Charge the radio.
12. Indicates the **channel number** that you stored
13. When the radio is in **reception mode**, this icon is displayed
14. Depending on the setting, it will show the frequency in use, the channel name, the menu setting, etc
15. Indicates the **VFO** in use and the current menu or function setting. This icon is displayed close to the band in use or to the menu settings.

Battery Level Indicator

When the battery level indicator reads  the battery is depleted. At this point the radio will start beeping periodically as well as flash the backlight of the display and when voice prompts are enabled, a "Low Voltage" announcement will be heard, indicating that you need to change your battery or put your radio in the charger.

4.3 Status Indications

The status LED has a very simple and traditional design.

LED Indicator	Radio Status
Constant Red	Transmitting.
Constant Green	Receiving.

4.4 Main keypad controls

- **[SOS] key:** Press it for a long time you will activate the alarm function. Press it again to turn off this feature.
- **[SK1] key:** Press it for a short time to turn on the FM radio. Press it again to turn it off.
- **[SK2] key:** Press it for a short time to light up the flashlight. If you push this button again, the flashlight will light up to strobe mode. Press **[SK2]** a third time to turn off the flashlight.
To activate the Monitor function presses the button for a long time.

- **[MENU]** key: It is used for activating the MENU, choose each MENU selection and confirm the parameter.
In the off state, press and hold this key to turn on the radio, allowing to switch between frequency (VFO) mode or memory (MR) mode.
To save frequencies to channel memory you must be in Frequency (VFO) mode. Memory mode is sometimes also referred to as Channel mode.
- **[▲]** key: Press it for more than 2 seconds, the channel and frequency will move upwards rapidly; in SCAN mode, press this control to move the scanning upwards.
- **[▼]** key: Keep it pressed it for more than 2 seconds, the channel and frequency will move downwards rapidly; in SCAN mode, press this control to move the scanning downwards.
- **[EXIT]** key: press to exit the Menu and functions. A/B (appears on the display): push to select the desired frequency (VHF or UHF) in the main or secondary display. When listening to broadcast FM, the **[EXIT]** key switches between 65-75 MHz and 76-108 MHz band.

• Numeric keypad

With these keys you can input the information or your selections on the radio. In tx mode, push the number keys to send a corresponding DTMF code.

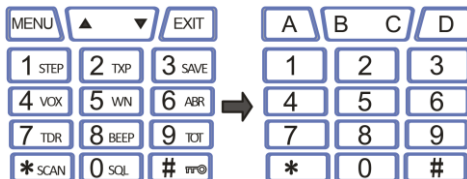

- ***SCAN Key**

A short momentary press of the key enables the reverse function.

When listening to broadcast FM a momentary press will start the scanning. Scanning in broadcast FM will stop as soon as an active station is found, regardless of scanner resume method.

To enable the scanner, press and hold the [***SCAN**] key for about two seconds.

- **Zero 0 Key**

The BAOFENG UV-9G features a battery voltage meter that the current voltage of the battery on the display.

To see the voltage displayed, press and hold the [**0SQL**] key for about two seconds.

- **#P0 key**

If you press shortly [**#P0**] you will switch to High /Middle /Low output power.

If you press this button for more than 2 seconds you will lock/unlock the keypad.

5. BASIC OPERATIONS

5.1 Power on the radio

• Turning the unit on

To turn the unit on, simply rotate the **Volume/Power** knob clockwise until you hear a "click". If your radio powers on correctly there should be an audible double beep after about one second and the display will show a message or flash the LCD depending on settings for about one second. Then it will display a frequency or channel. If the Voice prompt is enabled, the voice will announce "frequency mode" or "channel mode".

• Turning the unit off

Turn the **volume/power** knob counter-clock wise all the way until you hear a "click". The unit is now off.

5.2 Adjusting the volume

To turn up the volume, turn the volume/power knob clock-wise. To turn the volume down, turn the **volume/power** knob counter-clock-wise. Be careful not to turn it too far, as you may inadvertently turn your radio off.

5.3 Making a call

NOTE: Press the [EXIT] key to switch the main channel to the other channel if there is 2 channels shown on the display. In the off state, press and hold the [MENU] key to turn on the radio; it will switch between frequency mode or channel mode.

After selecting a channel, hold down the **[PTT]** key to initiate a call to the current channel. Speak into the microphone with normal tone. Initiate a call, the red LED is on.

When you release the **[PTT]** key, you can answer it without any action.

When receiving a call, the green LED is on.

NOTE: To ensure the best reception volume, keep the distance between the microphone and the mouth at the time of transmission from 2.5 cm to 5 cm.

NOTE: In frequency mode, transmission is prohibited.

5.4 Channel selection

There are two modes of operation: Frequency (VFO) mode, and Channel or Memory (MR) mode.

For everyday use, Channel (MR) mode is going to be a whole lot more practical than Frequency (VFO) mode. However, Frequency (VFO) mode is very handy for experimentation out in the field. Frequency (VFO) mode is also used for programming channels into memory.

In Channel (MR) mode you can navigate up and down the channel by using the ▲ and ▼ keys.

Ultimately which mode you end up using will depend entirely on your use case.

5.5 Frequency (VFO) mode

In Frequency (VFO) mode you can navigate up and down the band by using the ▲ and ▼ keys. Each press will increment or decrement your frequency according to the frequency step you've set your transceiver to.

You can also input frequencies directly on your numeric keypad with kilohertz accuracy.

The following example assumes the use of a 12.5 kHz frequency step.

Example. Entering the frequency 432.6125 MHz on display A

a. The off state, hold press [MENU] key to open the radio, switching to the frequency (VFO) mode.

b. Press [EXIT] until the ▲ icon appears next to the upper display. .

c. Enter [4][3][2][6][1][2][5] on the numeric keypad.

NOTE:

Frequency mode can be used for scanning channel storage and frequency scanning. It is forbidden to transmit in frequency mode.

WARNING!

Just because you can program in a channel does not mean you're automatically authorized to use that frequency. However, it is legal in most jurisdictions to listen. Contact your local regulatory body for further information on what laws, rules and regulations apply to your area.

5.6 Channel (MR) mode

The use of Channel (MR) mode is dependent on actually having programmed in some channels to use.

Once you have channels programmed and ready, you can use the ▲ and ▼ keys to navigate between channels.

NOTE:

Channels 1-30 are GMRS communication channels, which are allowed to be transmitted. However, these frequencies are

fixed and cannot be modified.

Channels 117-127 are NOAA channels, and the frequency is fixed and cannot be modified. It is allowed to scan and receive. Channel 55-116 is a user-defined scan receiving channel. Only the receiving frequency is allowed to be set, and the transmitting frequency is forbidden.

6. ADVANCED FEATURES

6.1 Frequency scanning

This function can scan the frequency.

- a. In frequency mode, press **[*SCAN]** key for more than 2 seconds. The radio will start scanning the frequency according to the set frequency step.
- b. You can change the scanning direction with the ▲ and ▼ keys.
- c. Press any key to stop the scanning.

Note: for Scan mode, see Menu No.18.

6.2 Channel scanning

This function can scan the channels.

- a. In channels mode, press **[*SCAN]** key for more than 2 seconds. The radio will start scanning according to the channel you set.
- b. You can change the scanning direction with the ▲ and ▼ keys.
- c. Press any key to stop scanning.

Note: for Scan mode, see Menu No.18.

6.3 Search CTCSS/DCS Code

With this function you can search and store the CTCSS/DCS code used by other radios.

Procedure:

- a. In frequency mode press **[MENU]+[1][1]**.
- b. Press **[MENU]** key again.
- c. Press **[*SCAN]** key; CT will blink on the display.
- d. When another radio is transmitting, the display will show the CTCSS/DCS code.

e. After searching the CTCSS code, the radio will beep and stop scanning.

f. After setting, press [MENU] key for confirmation and store, or press [PTT] or [EXIT] key to return to standby mode.

NOTE 1: The DCS scanning has the same procedure of CTCSS code, but you have to select MENU+10 to enter scanning.

NOTE 2: If CTCSS has not searched the code, you can search using the DCS mode.

6.4 Cursor ▼ ▲ Conversion (A/B)

Directly press [EXIT] key to move the cursor up and down. Then, you can modify or confirm the parameters indicated by the cursor.

Important1: UV-9G has a dual-frequency display function. In frequency mode, you will see on the display two different receiving and transmitting frequencies; while in channel mode the two different channels will be displayed.

Important2: In frequency or channel mode, press the [EXIT] key to shift between the main channel A and the sub-channel B ▲ on the display indicates on which channel (main channel A or sub channel B) you are operating.

▼ is displayed next to the channel.

6.5 Keypad lock

This function locks the keypad to prevent accidental pressure of the controls.

To unlock the keypad, press [#PTT] for more than 2 seconds.

6.6 FM Radio (FM)

The frequency range to listen to the radio is 65-108MHz. When listening to broadcast FM, press [EXIT] key switches between 65-75 MHz and 76-108 MHz band.

a. In frequency or channel mode, Press [SK1] to turn on the radio.

b. Select the desired radio frequency with the ▲ or ▼ keys or input the frequency. Or

- Press [*SCAN] to automatically search a radio station.

c. Press [SK1] to exit FM radio.

Note: while you are listening to the radio, the frequency or channel of A / B receiving signal will automatically switch to the frequency or channel mode for normal transmitting and receiving.

When the signal disappears the radio will automatically switch again to FM radio mode.

6.7 Flashlight

This function is very useful for night illumination.

To turn it on press MON; push it again, the flash light will be strobe; push it again: it will turn off.

6.8 TX 1000Hz, 1450Hz, 1750Hz, 2100Hz repeaters tone

Press [PTT] + [SOS] to send 1750Hz repeaters tone. This function is useful for communications through repeaters.

If you have the keypad lock enabled on your radio, you can still send a 1750Hz tone the regular way without having to unlock your radio.

6.9 Manual Programming (Scanning Channels Memory)

Memory channels are an easy way to store commonly used frequencies so that they can easily be retrieved at a later date. The BAOFENG UV-9G features 128 memory channels that each can hold: Receive frequencies, group signaling information, bandwidth, ANI/ PTT-ID settings and a six character alphanumeric identifier or channel name ¹.

Frequency Mode vs. Channel Mode

In the off state, press and hold the [MENU] key to turn on the radio; it will switch between frequency mode or channel mode.

These two modes have different functions and are often confused.

Frequency Mode (VFO) : Used for a temporary frequency assignment, such as a test frequency or quick field programming if permitted.

Channel Mode (MR) : Used for selecting preprogrammed channels.

Ex 1. Programming a Channel Repeater Offset with CTCSS Tone

EXAMPLE New memory in Channel 60:

RX = 432.000 MHz

- a. Turn off the radio.
- b. Hold press [MENU] key to open the radio, switching to the frequency mode.
Channel number at the right will disappear.
- c. [MENU] [2][8] [MENU] [6] [0] [MENU] [EXIT] Deletes Prior Data in channel (Ex. 60)

- d. **[MENU] [1][1] [MENU] 123.0 [MENU] [EXIT]** Selects desired RX encode tone
- e. Enter RX frequency (Ex. **432000**)
- f. **[MENU] [2][7] [MENU] [6][0] [MENU]** Enter the desired channel (Ex 60)
 -->>[EXIT] RX has been added
- g. In the off state, press and hold the **[MENU]** key to turn on the radio return to MR mode, and the channel number will reappear.

Ex 2. Programming a Simplex Channel with CTCSS tone

EXAMPLE New memory in Channel 60:

RX = **436000** MHz

RX CTCSS tone 123.0

- a. Change from Menu to Menu by pressing the **[EXIT]** button.
- b. The off state, hold press **[MENU]** key to open the radio, return to the frequency mode.
 Channel number at the right will disappear.
- c. **[MENU] [2][8][MENU] [6] [0] [MENU] [EXIT]** Deletes Prior Data in channel (Ex. 60)
- d. **[MENU] [1][1] [MENU] 123.0 [MENU] [EXIT]** Select desired RX encode tone (Ex 123 CTCSS)
 -->>Use [EXIT] to select Upper display
- e. Enter RX frequency (Ex. **436000**)
- f. **[MENU] [2][7] [MENU] [6][0] [MENU]** Enter the desired channel (Ex 60)
 -->> [EXIT] Channel has been added
- g. In the off state, press and hold the **[MENU]** key to turn on the radio return to MR mode, and the channel number will reappear.

7. WORKING THE MENU SYSTEM

For a complete reference on available menu items and parameters, see **Appendix C, Shortcut Menu operations**.

Note: in channel mode, the setting of these features is not possible: CTCSS/ DCS tones, wide/narrow bandwidth, PTT-ID, Busy channel lock out, channel name edit.

7.1 Basic use

Using the menu with arrow keys

- a. Press the **[MENU]** key to enter the menu.
- b. Use the **[▲]** and **[▼]** keys to navigate between menu items.
- c. Once you find the desired menu item, press **[MENU]** again to select that menu item.
- d. Use the **[▲]** and **[▼]** keys to select the desired parameter.
- e. When you've selected the parameter you want to set for a given menu item;
 - a). To confirm your selection, press **[MENU]** and it will save your setting and bring you back to the main menu.
 - b). To cancel your changes, press **[EXIT]** and it will reset that menu item and bring you out of the menu entirely.
- f. To exit out of the menu at any time, press the **[EXIT]** key.

7.2 Using short-cuts

As you may have noticed if you looked at **Appendix C, Shortcut Menu operations**, every menu item has a numerical value associated with it. These numbers can be used for direct access of any given menu item.

The parameters also have a number associated with them, see **Appendix C, Shortcut Menu operations** for details.

Using the menu with short-cuts

- a. Press the **[MENU]** key to enter the menu.
- b. Use the numerical keypad to enter the number of the menu item.
- c. To enter the menu item, press the **[MENU]** key.
- d. For entering the desired parameter you have two options:
 - a). Use the arrow keys as we did in the previous section; or
 - b). Use the numerical keypad to enter the numerical short-cut code.
- e. And just as in the previous section;
 - a). To confirm your selection, press **[MENU]** and it will save your setting and bring you back to the main menu.

- b). To cancel your changes, press **[EXIT]** and it will reset that menu item and bring you out of the menu entirely.
- f. To exit out of the menu at any time, press the **[EXIT]** key.
- g. All further examples and procedures in this manual will use the numerical menu short- cuts.

7.3 Functions and operations

(1) Squelch level (SQL) - MENU No.0

Thanks to this function you can adjust the squelch in 10 different levels:

- **level 0:** opened squelch. With this setting, UV-9G will detect all signals, also the weakest ones, but will also receive the background noise or undesired signals.
- **levels 1- 9:** level 1 (lowest squelch level), level 9 (highest squelch level).

If the squelch is set to the highest level, the radio will receive the strongest signals only.

(2) Step frequency (STEP) - MENU No.1

This function lets you select the desired frequency step.

The selectable steps are the following: 2.5/5.0/6.25/10.0/12.5/20.0/25.0/50.0 KHz

Note: in channel mode, this function cannot be modified.

(3) Output power (TXP) - MENU No.2

In this MENU you can select the high/middle/ low output power.

Low power $\leq 0.5W$; Middle power $\leq 2W$; High power $\leq 5W$

Note: select the output power can improve the quality of the call, while the low output power can reduce the radiation and the battery capacity loss. On channels 8-14, the output power cannot be modified.

(4) Battery save (SAVE) - MENU No.3

The power save feature enables a reduction in the consumption of the battery when the radio is in standby.

You have 5 selections available: OFF / 1:1 / 1:2 / 1:3 / 1:4.

For example: 1:1 = 1s' working and 1s' battery saving. 1:2 = 1s' working and 2s' battery saving.

(5) VOX Function (VOX) - MENU No.4

This function allows hands-free conversations: just speak in the direction of the microphone and the communication will be

automatically activated.

You can choose amongst 11 levels: OFF-10. 1 is the highest level, 10 is the lowest one.

Note: the higher is the level, the higher is the microphone sensitivity. The VOX function cannot be modified in SCAN and FM radio mode.

(6) Wide/Narrow bandwidth (WN) - MENU No.5

This function is used to set the working bandwidth of the radio.

You can choose between wide or narrow bandwidth.

WIDE: 25KHz, NARROW: 12.5KHz

Note: On channels 8-14, this function cannot be modified.

(7) Backlight (ABR) - MENU No. 6

With this function you can adjust the auto off time of the display backlight (1-5s).

Note: we suggest you setting 4-5s levels.

(8) Dual Watch Operation (TDR) - MENU No. 7

When this function is activated, you can receive the frequency of channel A and channel B at the same time.

If a signal is detected, the ▼/▲ pointer will blink on the corresponding channel or frequency.

Note: In Dual Watch operation mode, you can change the parameter of AB channel or frequency freely.

(9) Keypad beep (BEEP) - MENU No. 8

When this function is enabled, every time a button is pressed, you will hear a beep tone.

(10) Time-Out-Timer (TOT) - MENU No.9

The TOT function is used to prevent a too long transmission and limits the tx time: TOT temporarily stops the transmission if the radio has been used beyond the max pre-set time (for example 15s, 30s, 45s, etc).

(11) Receiving DCS (R-DCS) - MENU No.10

DCS codes are similar to access codes and can be added to channels, so as to create a sort of personal channel. They enable the radio to communicate with the users that are tuned on the same channel and have set the same DCS code.

You can choose amongst:

- **OFF:** OFF
- **R-DCS:** D023N-D754N (Normal DCS)
- **R-DCS:** D023I-D754I (Inverse DCS)

Note: In UV-9G there are 208 groups of normal and inverse DCS codes. This function cannot be amended in channel mode.

(12) Receiving CTCSS (R-CTCSS) - MENU No.11

As DCS codes, the CTCSS codes can be added to the channels for creating new private channels.

Note: there are 50 groups of CTCSS tones. In channel mode the CTCSS tones cannot be changed.

(13) Transmitting DCS - (T-DCS) - MENU No.12

In this Menu you activate DCS codes in tx mode. You can choose between normal R-DCS (D023N-D754N) and inverted R-DCS (D023I-D754I)

Note: the groups of DCS codes are 208. DCS codes cannot be changed in channel mode.

(14) Transmitting CTCSS (T-CTCSS) - MENU No.13

In this Menu you can set a CTCSS tone in tx mode.

You can choose: OFF or CTCSS (67.0 to 254.1 Hz)

Note: there are 50 groups of CTCSS tones. In channel mode the CTCSS tones cannot be changed.

(15) Voice function (VOICE) - MENU No. 14

With this function, you activate a voice that informs you about any operation/ selection you are doing.

(16) ANI-ID (ANI-ID) - MENU No.15

With this function you can set your ID-code. It can be programmed by the proper programming software. You can edit up to 5 digits.

(17) DTMFST (DTMFST) - MENU No.16

Determines when DTMF Side Tones can be heard from the transceiver speaker.

(18) Signal code (S-CODE) - MENU No.17

Selects 1 of 15 DTMF codes. The DTMF codes are programmed with software and are up to 5 digits each.

(19) SCAN Resume Mode (SC-REV) - MENU No.18

Thanks to this function, UV-9G can SCAN in frequency or channel mode. You can choose amongst three options:

- **TO: Time-operated SCAN**

Whenever a signal is detected, the radio will suspend the SCAN for 5 seconds, and then will continue to SCAN even if the signal is still present.

- **CO: Carrier-operated SCAN**

Whenever a signal is detected, the radio will stop scanning. It will resume to SCAN once the signal will disappear.

- **SE: Search SCAN**

The radio will stop scanning once a signal is detected.

(20) PTT-ID (PTT-ID) - MENU No.19

With this function you can decide when sending the ANI-ID code in tx mode.

You can choose amongst 4 possibilities.

- **OFF:** press PTT to turn it off
- **BOT:** the code is sent when you press the PTT
- **EOT:** the code is sent when the PTT is released
- **BOTH:** the code is sent when you press and release the PTT

Note: select 'OFF' when using in case of affecting the radio.

(21) PTT ID delay (PTT-LT) - MENU No.20

In this MENU you can set the delay time (0-30ms) sending the PTT-ID.

Note: select '0' in normal using.

(22) Channel A Display Mode (MDF-A) - MENU No.21

This function is used to set the display mode of channel A.

Display modes:

- **FREQ.:** Frequency + channel No.
- **CH:** Channel number
- **NAME:** Channel name

Note: Channel name mode must be set by the programming software. Up to three numbers or characters can be edited.

(23) Channel B Display Mode (MDF-B) - MENU No.22

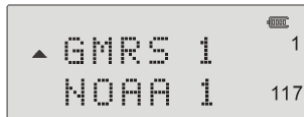

In this menu you can delete a channel of the radio.

(30) Standby backlight (WT-LED) - MENU No.29

In this MENU you can choose the color of the backlight when the radio is in standby mode.

You can choose amongst:

- **OFF** (backlight off)
- **PURPLE**
- **BLUE**
- **ORANGE**

(31) RX backlight (RX-LED) - MENU No. 30

In this MENU you can choose the backlight color when the radio is receiving.

You can choose amongst:

- **OFF** (backlight off)
- **PURPLE**
- **BLUE**
- **ORANGE**

(32) TX backlight (TX-LED) - MENU No.31

You can choose the backlight color when the radio is transmitting.

Available colors:

- **OFF** (backlight off)
- **PURPLE**
- **BLUE**
- **ORANGE**

(33) Alarm Mode (AL-MOD) - MENU No.32

This function can set the tone alarm/code alarm/site alarm of the radio.

Keep pressed the **[CALL]** key for 3 seconds to start the alarm tone.

The following three options can be selected:

- **SITE:** the speaker emits an alarm tone but the radio doesn't transmit;
- **-tone:** the speaker emits an alarm tone and the radio transmits it;
- **CODE:** the speaker emits an alarm tone and the radio transmits it followed by ANI-ID code.

(34) Dual Watch (TDR-AB) - Menu No.34

When this function is on, you may receive signals of A/B channel or frequency. It can also be used for cross band receiving and transmitting. You can choose amongst the following settings:

OFF: UV-9G can receive in both VFO (not simultaneously); ▲ or ▼ will blink on the transmitting frequency band.

A: The radio can receive in both VFO (not simultaneously) but can transmit in VFO A only.

B: UV-9G can receive in both VFO (not simultaneously) but can transmit in VFO B only.

If you choose option A, it means that 432.5875MHz is the tx frequency band, while 145.550MHz is the rx frequency band; the upper VFO shows 432.5875 MHz while in the lower VFO 145.550MHz will be displayed; you can receive on both 432.5875 MHz and 145.550 MHz, but can transmit on 432.5875 MHz only.

While if you choose option B, 145.550MHz is the tx frequency band and 432.5875MHz is the rx frequency band. In the upper VFO 432.5875 MHz will be displayed while the lower VFO will show 145.550 MHz; you can receive on both 432.5875 MHz and 145.550 MHz, but transmit on 145.550 MHz only. Example: the LCD displays

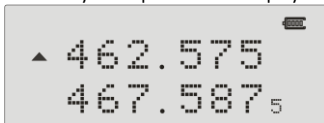

(35) Side tone elimination (STE) - Menu No. 35

This feature is helpful to eliminate the annoying audio tone after the transmission is finished (end transmission noise muffler).

(36) Side tone elimination in communication through repeater (RP-STE) - Menu No. 36

This function is used when the radio operates through a repeater; when the PTT is released, the repeater will emit the end transmission tone to confirm it is working.

Available settings:

OFF 1,2,3,4,5,.....10 to set the delay time.

Note: Please disable this function in normal using, lest affect your normal conversation.

(37) Delay time of side tone elimination in communication through repeater (RPT-RL) - Menu No.37

With this function you have the confirmation that the repeater has transferred the signal. You can choose amongst: OFF 1,2,3,4,5,.....10 to set the delay time.

(38) Display mode at the turning on (PONMSG) Menu No.38

With this function you can set the display mode when the radio is turned on. Available options:

- **FULL:** full frequency character is displayed.
- **MSG: UV-9G is displayed.**

(39) Roger beep (ROGER) - Menu No. 39

When the PTT is released, the radio will beep to confirm to other users that you have finished your transmission and that they can start talking.

(40) Reset (RESET) - Menu No.40

With this function you can reset the transceiver to the factory-programmed settings and parameters. After that, you can set the desired functions.

There are two types of reset:

- **VFO:** Menu Reset
- **ALL:** Menu and channel Reset

(41) 1000Hz, 1450Hz, 1750Hz, 2100Hz Repeater Tone (R-TONE) - Menu No.41

With this function you can select **1000Hz, 1450Hz, 1750Hz, 2100Hz** repeater tone. To send out a repeater tone; You hold down the [PTT] + [SOS] key.

If you have the keypad lock enabled on your radio, you can still send a 1750Hz tone the regular way without having to unlock your radio.

Appendix A. – Trouble shooting guide

Phenomena	Analysis	Solution
You cannot turn on the radio.	The battery may be installed improperly.	Remove and reattach the battery.
	The battery power may run out.	Recharge or replace the battery.
	The battery may suffer from poor contact caused by dirty or damaged battery contacts.	Clean the battery contacts or replace the battery.
During receiving, the voice is weak or intermittent.	The battery voltage maybe low.	Recharge or replace the battery.
	The volume level may be low.	Increase the volume.
	The antenna maybe loose or maybe installed incorrectly.	Turnoff the radio, and then remove and reattach the antenna.
	The speaker maybe blocked.	Clean the surface of the speaker.
You cannot communicate with other group members.	The frequency or signaling type maybe inconsistent with that of other members.	Verify that your TX/RX frequency and signaling type are correct.
	You may be too far away from other members.	Move towards other members.
You hear unknown voices or noise.	You may be interrupted by radios using the same frequency.	Change the frequency, or adjust the squelch level.
	The radio in analog mode maybe set with no signaling.	Request your dealer to set signaling for the current channel to avoid interference
You are unable to hear anyone because of too much noise and hiss.	You may be too far away from other members.	Move towards other members.
	You may be in an unfavorable position. For example, your communication may be blocked by high buildings or blocked in an underground area.	Move to an open and flat area, restart the radio, and try again.
	It may be the result of external disturbance (such as electromagnetic interference).	Stay away from equipment that may cause interference.
The radio keeps transmitting.	VOX may be turned on or the headset is not installed in place	Turn off the VOX function. Check that the headphones are in place.

NOTE: If the above solutions cannot fix your problems, or you may have some other queries, please contact your dealer for more technical support.

Appendix B. - Technical Specifications



Frequency Range	136.0-174.0 & 400.0-480.0MHz (Scanning Receiver) GMRS 462.5500 ~ 467.7250 MHz (Rx & Tx)
Memory Channel	30 GMRS Channels + 11NOAA Weather + 87Scanner Channels
Operation Voltage	DC 7.4 V \pm 10%
Battery Capacity	1800mAh (Li-Ion)
Transmission current	\leq 1500mA
Receive Sensitivity	0.25 μ V (12dB SINAD)
Power Output	1W @16 ohms
Receive current	\leq 380mA
Rated Audio Distortion	\leq 5%
Connection for accessories	2 pin Kenwood jack

ATTENTION!

Operating frequency is divided into transmit and receive frequencies, please comply with the Radio Regulations in this country or territory.

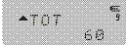
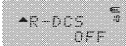

Appendix C. - Shortcut Menu operations

MENU No.	Name (Full Name)	Enter item	LCD display	Selectable
0	SQL - Squelch Level	MENU+0		0-9 Levels 0:Lowest 9:Highest
1	STEP –Step Frequency	MENU+1		2.5K/5.0K/6.25K/10.0K 12.5K/20.0K/25.0K/50.0K
2	TXP – Transmit Power	MENU+2		HIGH:5W Low:1W On channels 8-14, the output power cannot be modified.
3	SAVE - Battery Saving	MENU+3		OFF: 1:1 2:2 3:3 4:4
4	VOX - VOX	MENU+4		OFF, 1-9 OFF: off 1:Highest Sensitivity 9:Highest Sensitivity
5	WN-Wide/Narrow Bandwidth	MENU+5		WIDE:25.0K NARR:12.5K On channels 8-14, this function cannot be modified.

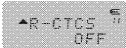
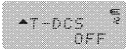
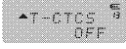
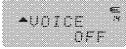
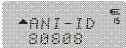
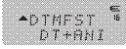
6	ABR –Auto Backlight	MENU+6		OFF/1,2,3...8, 9,10 *Time-out for the LCD backlight. (seconds)
7	TDR – Dual Watch Operation	MENU+7		OFF ON *Monitor [A] and [B] at the same time. The display with the most recent activity ([A] or [B]) becomes the selected display.
8	BEEP - Keypad Beep	MENU+8		OFF ON *Allows audible confirmation of a key press.
9	TOT- Time-Out-Timer	MENU+9		15,30...600S *This feature provides a safety switch that limits transmission time to a programmed value. This will promote battery conservation by not allowing you to make excessively long transmissions, and in the event of a stuck PTT switch it can prevent interference to other users as well as battery depletion
10	R-DCS - Receiver DCS	MENU+10		OFF D023I ...D754I D023N...D754N *Mutes the speaker of the transceiver in the absence of a specific low-level digital signal. If the station you are listening to does not transmit this specific signal, you will not hear anything.

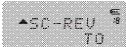
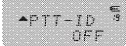
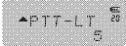
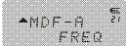
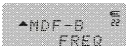
11	R-CTCS - Receiver CTCSS	MENU+11		OFF 67.0HZ...254.1HZ *Mutes the speaker of the transceiver in the absence of a specific and continuous sub-audible signal. If the station you are Listening to does not transmit this specific and continuous signal, you will not hear anything.
12	T-DCS -Transmitter DCS	MENU+12		OFF D023N...D754N D023I ...D754I *Transmits a specific low-level digital signal to unlock the squelch of a distant receiver (usually a repeater).
13	T-CTCS - Transmitter CTCSS	MENU+13		OFF 67.0HZ...254.1HZ *Transmits a specific and continuous sub audible signal to unlock the squelch of a distant receiver (usually a repeater).
14	VOICE - Voice Reminding	MENU+14		OFF CHI ENG *Allows audible voice confirmation of a key press.
15	ANI-ID -ANI-ID	MENU+15		It can be programmed by software
16	DTMFST - DTMFST	MENU+16		OFF: No DTMF Side Tones are heard DT-ST : Side Tones are heard only from manually keyed DTMF codes ANI-ST: Side Tones are heard only from automatically keyed DTMF codes DT+ANI : All DTMF Side Tones are heard

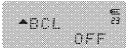
17	S-CODE - Signal Code	MENU+17		1,...,15
18	SC-REV - Scanner Resume Method	MENU+18		TO : Time Operation - scanning will resume after a fixed time has passed CO : Carrier Operation -scanning will resume after the signal disappears SE : Search Operation -scanning will not resume
19	PTT-ID - PTT-ID	MENU+19		OFF: No ID is sent BOT: The selected S-CODE is sent at the beginning EOT: The selected S-CODE is sent at the ending BOTH : The selected S-CODE is sent at the beginning and ending
20	PTT-LT – PTT ID delay	MENU+20		0,1,2,...,50ms *PTT-ID Delay (milliseconds)
21	MDF-A - Channel A Display Mode	MENU+21		FREQ: Displays programmed Frequency CH: Displays the channel number NAME: Displays the channel name *Note: Names must be entered using software.
22	MDF-B - Channel B Display Mode	MENU+22		FREQ: Displays programmed Frequency CH: Displays the channel number NAME: Displays the channel name *Note: Names must be entered using software.

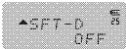
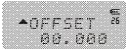
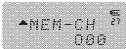
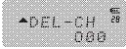
23	BCL – Busy Channel Lock-out	MENU+23		OFF ON *Disables the [PTT] button on a channel that is already in use. The transceiver will sound a beep tone and will not transmit if the [PTT] button is pressed when a channel is already in use.
24	AUTOLK – Automatic Keypad Lock	MENU+24		OFF ON *When ON, the keypad will be locked if not used in 8 seconds. Pressing the [#PTT] key for 2 seconds will unlock the keypad.
25	SFT-D – Frequency Offset Direction	MENU+25		OFF: TX = RX (simplex) +: TX will be shifted higher in frequency than RX - : TX will be shifted lower in frequency than RX
26	OFFSET -Frequency shift amount	MENU+26		00.000...69.990 *Specifies the difference between the TX and RX frequencies
27	MEM-CH - Store a Memory Channel	MENU+27		000...127 *This menu is used to either create new or modify existing channels (0 through 127) so that they can be accessed from MR/Channel Mode
28	DEL-CH - Delete a memory channel	MENU+28		000...127 *This menu is used to delete the programmed information from the specified channel (0 through 127) so that it can either be programmed again or be left empty.

Appendix D. - GMRS Frequency Chart (MHz)

CH.No	CH.Freq.	CH.No	CH.Freq.	CH.No	CH.Freq.
1	462.5625	11	467.6375	21	462.7000
2	462.5875	12	467.6625	22	462.7250
3	462.6125	13	467.6875	23	467.5500 (Tx)/ 462.5500 (Rx)
4	462.6375	14	467.7125	24	467.5750(Tx)/ 462.5750(Rx)
5	462.6625	15	462.5500	25	467.6000 (Tx)/ 462.6000(Rx)
6	462.6875	16	462.5750	26	467.6250(Tx)/ 462.6250(Rx)
7	462.7125	17	462.6000	27	467.6500(Tx)/ 462.6500(Rx)
8	467.5625	18	462.6250	28	467.6750(Tx)/ 462.6750(Rx)
9	467.5875	19	462.6500	29	467.7000(Tx)/ 462.7000(Rx)
10	467.6125	20	462.6750	30	467.7250(Tx)/ 462.7250(Rx)

Appendix E. - Weather Channel Assignments

Channel Number	RX Frequency MHz	Weather Channel	Channel Number	RX Frequency MHz	Weather Channel
117	162.550	WX1	123	162.525	WX 7
118	162.400	WX 2	124	161.650	WX 8
119	162.475	WX 3	125	161.775	WX 9
120	162.425	WX 4	126	161.750	WX 10
121	162.450	WX 5	127	162.000	WX 11
122	162.500	WX 6	---	---	---

Disclaimer

The Company endeavors to achieve the accuracy and completeness of this manual, but no warranty of accuracy or reliability is given. All the specifications and designs are subject to change without notice due to continuous technological development. No part of this manual may be copied, modified, translated, or distributed in any manner without the prior written consent of the Company.

We do not guarantee, for any particular purpose, the accuracy, validity, timeliness, legitimacy or completeness of the



WARNING: MODIFICATION OF THIS DEVICE TO RECEIVE CELLULAR RADIOTELEPHONE SERVICE SIGNALS IS PROHIBITED UNDER FCC RULES AND FEDERAL LAW.

BAOFENG

FIND TUTORIALS, SUPPORT AND MORE

www.baofengradio.com

 <https://www.facebook.com/BaofengOfficial>



FC CE 06780  **ROHS**

Print version: UV-9G_GMRS_V2.0