



Designed by SainSonic , Produced by BAOFENG



GT-3WP

SainSONIC® | BAOFENG

PREFACE

Thank you for purchasing SainSonic Amateur Portable Radio. We always offer high performance, stable wireless two way radio. BAOFENG factory developed GT-3WP water proof two way radio, especially for maritime, shipping users. Please read this manual carefully before use. The information presented herein will help you to drive maximum performance from your radio.

SAFETY INFORMATION:

The following safety precautions shall always be observed during operation, service and repair of this equipment.

- This equipment shall be serviced by qualified technicians only.
- Do not modify the radio for any reason.
- Use only BAOFENG supplied or approved batteries and chargers.
- Do not use any portable radio that has a damaged antenna. If a damaged antenna comes into contact with your skin, a minor burn can result.
- Turn off your radio prior to entering any area with explosive and flammable materials.
- Do not charge your battery in a location with explosive and flammable materials.
- To avoid electromagnetic interference and/or compatibility conflicts, turn off your radio in any area where posted notices instruct you to do so.
- Turn off your radio before boarding an aircraft. Any use of a radio must be in accordance with airline regulations or crew instructions.
- Turn off your radio before entering a blasting area.
- For vehicles with an air bag, do not place a radio in the area over an air bag or in the air bag deployment area.
- Do not expose the radio to direct sunlight over a long time, nor place it close to heating source.
- When transmitting with a portable radio, hold the radio in a vertical position with the microphone 3 to 4 centimeters away from your lips. Keep antenna at least 2.5 centimeters away from your body when transmitting.



WARNING: If you wear a radio on your body, ensure the radio and its antenna are at least 2.5 centimeters away from your body when transmitting.

CONTENT

FEATURES AND FUNCTIONS	i
UNPACKING AND CHECKING EQUIPMENTS	01
OPTIONAL ACCESSORIES	01
INSTALLATION OF ACCESSORIES	02
1.INSTALLING THE ANTENNA	02
2.INSTALLING THE BELT CLIP	02
3.MICRO-HEADSET INSTALLATION OF EXTERNAL	03
4.BATTERY INSTALLATION	03
BATTERY CHARGING	04
BATTERY INFORMATION	05
1.INITIAL USE	05
2.BATTERY TIPS	05
3.PROLONG BATTERY LIFE	06
4.BATTERY STORAGE	06
PARTS, CONTROLS AND KEYS	07
1.RADIO OVERVIEW	07
2.COMMAND/KEY DEFINITION	08
"LCD" DISPLAY	09
BASIC OPERATION	10
1.RADIO ON-OFF/VOLUME CONTROL	10
2.Transmit and Receive	11
3.FUNCTION "VOX" (VOICE OPERATED TRANSMISSION)	11
4-AUTOLK (keypad Locked Automatically)	12
5.VFO/Channel mode	12
6.TDR (Dual Watch/ Dual Reception)	13
7.DEL-CH (Delete Channel)	13
8. MEM-CH (Stored In Memory Channel)	13
9. CTCSS/DCS SCANNING	15
10.REPEATER TAIL TONE	15
11.CTCSS/DCS	16
CTCSS TABLE	17
DCS TABLE	17
SHORTCUT MENU OPERATION	19
SET MENU DESCRIPTION	20
Reset(Restore To Default Setting)	22
COPYING	22
TECHNICAL SPECIFICATION	23
1.GENERAL	23
2.TRANSMITTER	24
3. RECEIVER	24
TROUBLESHOOTING	25
WARRANTY: (Better buy the radios from local dealer)	27

FEATURES AND FUNCTIONS:

This is a GT-3WP dust and waterproof resisting two way radio. After 30 minutes into one meter underwater, the radio still works very well. So that its ensure the product reliability in wet environments.

Drop resistance, Rolling resistance
Chinese /English Switchover

- Dual-band handheld transceiver, with display function menu on the display "LCD".
Working Frequency: VHF130-176MHz & UHF400-520MHz
- High power/ mid / low (5 W/3W/1 W) selectable
- Up to 128 memory channels.
- Cross band reception/transmission
- A variety of display channel number, frequency, channel frequency, channel name, etc.
- CTCSS & DCS
- Tone end of transmission
- Function "VOX" (voice operated transmission).
- DTMF emergency alarm
- ANI code
- Selectable Frequency Step 2.5/5/6.25/10/12.5/20/25/50 kHz
- Frequency reverse
- Battery saving function "SAVE".
- Emergency SOS sound and light alarm
- Programmable by PC.
- Broadband (Wide 25KHz) / Narrowband (Narrow 12.5KHz), selectable..
- Commercial FM radio receiver (65 MHz ~ 108 MHz).
- Display illumination and programmable keyboard.
- Built-in LED flashlight

UNPACKING AND CHECKING EQUIPMENTS:

Carefully unpack the transceiver. We recommend that you identify the items listed in the following before discarding the packing material. If any items are missing or have been damaged during shipment, please contact your dealers immediately.

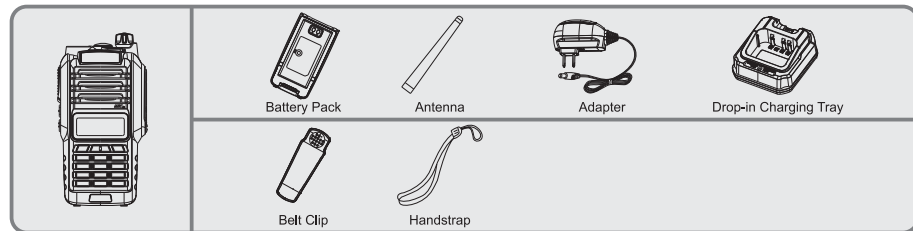

Note:

Items included in the package, may differ from those listed in the table above depending on the country of purchase. For more information, consult your dealer or vendor.

OPTIONAL ACCESSORIES:

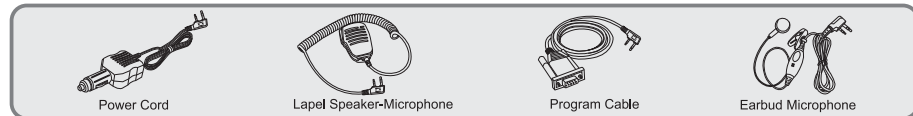

Note:

Consult the dealer or retailer for information about options available.

INSTALLATION OF ACCESSORIES:

1. INSTALLING THE ANTENNA:

Install the antenna as shown in the figure below and turn it clockwise until it stops.

Note:

- When installing the antenna, don't rotate it by its top, holding it by its base and turn.
- If you use an external antenna, make sure the "SWR" is about 1.5:1 or less, to avoid damage to the transceiver's final transistors.
- Do not hold the antenna with your hand or wrap the outside of it to avoid bad operation of the transceiver.
- Never transmit without an antenna.

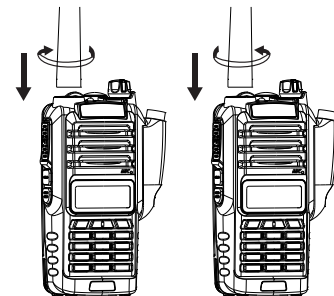

2. INSTALLING THE BELT CLIP:

If necessary, install the belt clip at the rear of the battery compartment cover as shown in the figure below.

Note:

- Do not use any kind of glue to fix the screw on the belt clip. The solvents Glue may damage the battery casing.

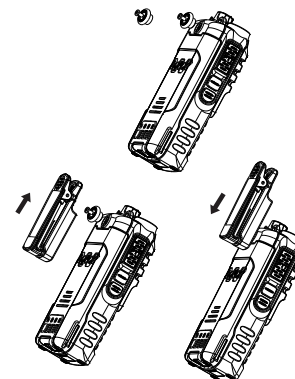

3. MICRO-HEADSET INSTALLATION OF EXTERNAL:

Plug the external micro-headset connector into the jack of "SP. & MIC" of the transceiver as shown in the figure below.

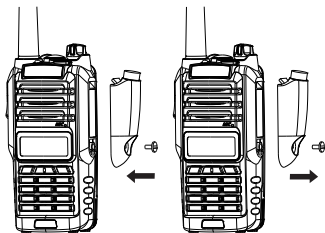

4. BATTERY INSTALLATION:

When attaching the battery, make sure the battery is in parallel and in good contact with the aluminum chassis. The battery bottom is about 1 to 2 centimeters below the bottom of the radio's body.

Align the battery with the guide rails on the aluminum chassis and slide it upwards until a "click" is heard.

The battery latch at the bottom locks the battery.

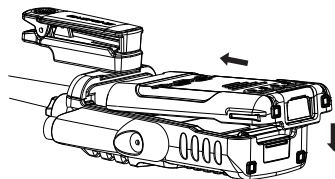

Turn off the radio before removing the battery.

Slide the battery latch, at the bottom of the radio's body, in the direction indicated by the arrow.

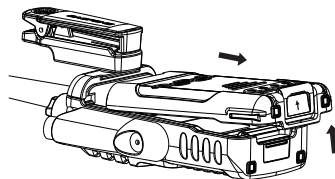

Slide down the battery for about 1 to 2 centimeters, and then remove the battery from the radio's body.

BATTERY CHARGING:

Use only the charger specified by the manufacturer. The charger's LED indicates the charging progress.

CHARGING STATUS	LED INDICATION
Standby (no-load)	Red LED flashes, while Green LED glows
Charging	Red LED solidly glows
Fully Charged	Green LED solidly glows
Error	Red LED flashes, while Green LED glows

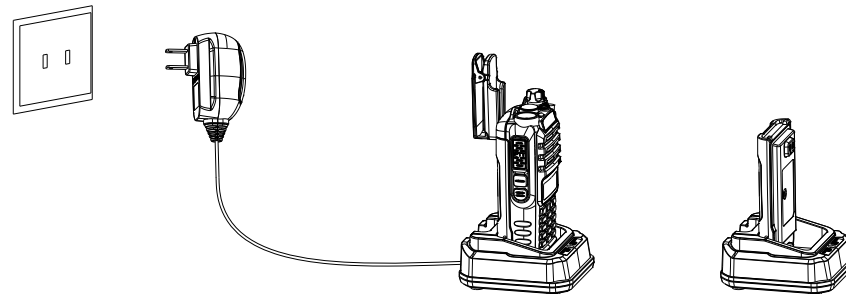

Please follow these steps:

1. Plug the power cord into the adapter.
2. Plug the AC connector of the adapter into the AC outlet socket.
3. Plug the DC connector of the adapter into the DC socket on the back of the charger.

4. Place the radio with the battery attached, or the battery alone, in the charger.
5. Make sure the battery is in good contact with the charging terminals. The charging process initiates when the red LED lights.
6. The green LED lights about 4 hours later indicating the battery is fully charged. Then remove the radio with the battery attached or the battery alone from the charger.

BATTERY INFORMATION:

1.INITIAL USE

New batteries are shipped uncharged fully from the factory. Charge a new battery for 5 hours before initial use. The maximum battery capacity and performance is achieved after three full charge/discharge cycles. If you notice the battery power runs low, please recharge the battery.

WARNING: • To reduce the risk of injury, charge only the battery specified by the manufacturer. Other batteries may burst, causing bodily injury and property damage.



- To avoid risk of personal injury, do not dispose of batteries in a fire!
- Dispose of batteries according to local regulations (e.g. recycling). Do not dispose as household waste.
- Never attempt to disassemble the battery.

2.BATTERY TIPS:

1. When charging your battery, keep it at a temperature among 5°C - 40°C. Temperature out of the limit may cause battery leakage or damage.
2. When charging a battery attached to a radio, turn the radio off to ensure a full charge.
3. Do not cut off the power supply or remove the battery when charging a battery.

4. Never charge a battery that is wet. Please dry it with a soft cloth prior to charge.
5. The battery will eventually wear out. When the operating time (talk-time and standby time) is noticeably shorter than normal performance, it is time to buy a new battery.

3.PROLONG BATTERY LIFE:

1. Battery performance will be greatly decreased at a temperature below 0°C. A spare battery is necessary in cold weather. The cold battery unable to work in this situation may work under room temperature, so keep it for later use.
2. The dust on the battery contact may cause the battery cannot work or charge. Please use a clean dry cloth to wipe it before attaching the battery to the radio.

4.BATTERY STORAGE:

1. Fully charge a battery before you store it for a long time, to avoid battery damage due to over-discharge.
2. Recharge a battery after several months' storage (Li-Ion batteries: 6 months), to avoid battery capacity reduction due to over-discharge.
3. Store your battery in a cool and dry place under room temperature, to reduce self-discharge.

PARTS, CONTROLS AND KEYS:

1.RADIO OVERVIEW:

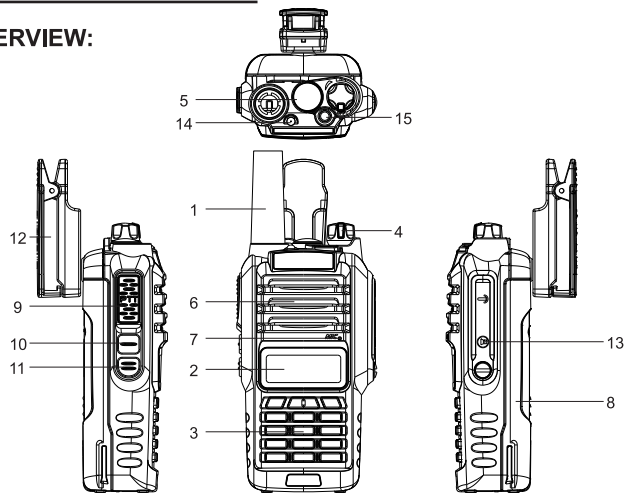

1.Antenna	6.Speaker	11. SK-side key2/M
2. LCD	7. Microphone	12. Strap buckle
3. Keypad	8.Battery latch	13. Accessory jack
4. Knob (ON/OFF, volume)	9.PTT	14. LED indicator
5.Flashlight	10. SK-side key1/F	15. Alarm key

2.COMMAND/KEY DEFINITION:

Power On:

Rotate PWR/VOL Switch clockwise, you will hear a sound "Beep", report the present channel, the transceiver is ready for working, meanwhile rotate PWR/VOL Switch to adjust the volume

[SOS]Emergency Alarm:

Long press[SOS] to open the alarm function, at this moment, the green light, red light, hand lamp flashes shin at the same time. Press this button again to release the alarm.

[PTT]:

Press and hold PTT button , then talk to the microphone. Release PTT to receive.

SK-SIDE KEY1/[F]:

Press the [F] button, to activate the FM Radio on; Press it again to deactivate the FM Radio.

SK-SIDE KEY2/[M]:

Press the [M] button, to turn on the flashlight; Press it again to turn off. Press and hold on the [M] button, to monitor the signal.

FUNCTION KEYPAD:

[MENU] key:

To enter the menu of the radio and confirm the setting.
Press and hold [MENU] button, then power on, to switch the frequency mode and channel mode.

[▲] [▼]key:

Press and hold [▲] or [▼] key for frequency up or down fast.
Press [▲] or [▼] key, the scanning will be opposite.

[EXIT/AB]key:

To cancel /clear or exit.

While standby, press [EXIT/AB] key to switch between Channel A and Channel B.

Under FM radio mode, press [EXIT/AB] key to switch the FM radio band 65-75MHz/76-108MHz.

NUMERIC KEYPAD:

Used to enter information for programming the radio's lists and the non-standard CTCSS

Under transmission mode, press the numeric key to send the signal code(the code should be set by PC software).



"LCD" DISPLAY:

The display icons appear when certain operations or specific features are activated.

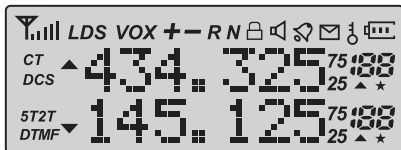

Icon	Description
CT	'CTCSS' activated.
DCS	'DCS' activated.

+	Frequency Shift +
-	Frequency Shift -
+ -	Frequency offset direction for accessing repeaters.
S	Dual Watch/Dual Reception functions activated.
VOX	Function 'VOX' enabled.
R	Reverse function activated.
N	Wide Band selected.
☰	Battery Level indicator
🔒	Keypad lock function activated.
L	Low transmit power.
▲▼	Operation frequency.
📶	Signal Strength Level.
:88	Operating channel.
75 25	Operating frequency.

BASIC OPERATION:

1.RADIO ON-OFF/VOLUME CONTROL:

Make sure the antenna and battery are installed correctly and the battery charged. Rotate the knob clockwise to turn the radio on, and rotate the knob fully counter-clockwise until

a 'click' is heard to turn the radio off. Turn the knob clockwise to increase the volume, or counter-clockwise to decrease the volume

Caution: The radio will not sound 'click' if you turn off the voice prompt function.
The boot mode display can be set from Function 38

2. Transmit and Receive:

Choose the correct channel No. or enter the frequency which you need, Then press and hold PTT button, the radio is transmitting now, then talk to the microphone, your sound will be transmitted. Release PTT to receive.

When you press PTT, the LCD shows L, it means the radio is in low power
When you press PTT, the LCD shows M, it means the radio is in Mid power
When you press PTT, the LCD shows H, it means the radio is in High power
Press [PTT] and then press [SOS] to transmit 1750HZ
Press [PTT] then press DTMF Numbers to transmit DTMF

3.FUNCTION "VOX" (VOICE OPERATED TRANSMISSION):

This function is not necessary to push the [PTT] on the transceiver for a transmission. Transmission is activated automatically by detecting the radio voice. When finish speaking, the transmission automatically terminated and the transceiver will automatically receive signal. Be sure to adjust the VOX Gain level to an appropriate sensitivity to allow smooth transmission.

Operate:

- 1.Press[MENU] to menu setting
- 2.Press [▲] or [▼] to Function 4, the screen shows

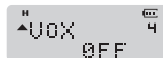

- 3.Press [MENU], sound "VOX" then press [▲] or [▼] to choose the level 1-10, 10 is the most sensitive level
- 4.Press[MENU] to confirm the setting. The LCD screen shows VOX after this function was setting, for example,
- 5.You can choose the VOX level to OFF, and press[MENU] then you will off this function

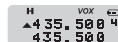

4-AUTOLK (keypad Locked Automatically)

The transceiver has two options: auto lock and manual lock

OFF: Turn off auto lock

ON: When you set autolock the keyboard press for more than 2 seconds

Operate:

In standby, press [menu] + number key 24, then the screen will display "AUTOLK"
Press [MENU] enter, then press [up] and [down] to select keyboard lock ON or OFF
Press [MENU] to confirm, then press [EXIT] to return to standby.

5.VFO/Channel mode

Turn off the radio, then press [MENU] and rotate the sound knob to turn on the radio, the screen

shows or the lower right corner of the LCD displays the channel

number, which means its in the channel mode. In this way, you can also change the channel mode to VFO

SELECTING A FREQUENCY OR CHANNEL:

Press the key [▲] or [▼] to select the desired frequency/channel you want. The display shows the frequency / channel selected.

Press and hold down the key [▲] or [▼] for frequency up or down fast.

When the radio is on VFO mode, the frequency can be input by the keypad directly.

Note:

- You can not select a channel without previously stored.

6.TDR (Dual Watch/ Dual Reception)

This feature allows you to operate between frequency A and frequency B. Periodically, the transceiver checks whether a signal is received on another frequency that we have scheduled. If you receive a signal, the unit will remain in the frequency until the received signal disappears.

In standby, press[MENU] + keyboard [7TDR] and then screen will display 'TDR'. Press [MENU] enter, then press [UP] or [DOWN] to select 'TDR' OFF or ON. Press [MENU] to confirm, then press [EXIT] to return to standby.

7.DEL-CH (Delete Channel)

In standby, press [MENU]+ [Number key 28] and then screen will display 'DEL-CH' Press [MENU] enter, press [UP] or [DOWN] to select the channel you want to delete. Press [MENU] to confirm, then press [EXIT] to return to standby.

The transceiver has 128 memory channels from 000 to 127. Operate invalid when you into channel without DH- display, it means this channel not parameter.

8. MEM-CH (Stored In Memory Channel)

When transceiver works in frequency mode or in standby, input the frequency and any kind of parameter you want to store.

In standby, press [MENU] +[Number key 27] and then screen will display 'MEM-CH' , then press [MENU] enter, press [UP] or [DOWN] to select the desired channel order. Press [MENU] to confirm then press [EXIT] to return to standby.

A complete memory channel includes RX frequency, TX frequency, CTCSS, DCS, RF Power, Bandwidth, PTT-ID, BCL, ANI, Scan add to, Channel Name, etc. Except for the setting of Scan add to and Channel Name, other settings could be finished by keypad under VFO mode.

Example: We want programming all the data into CH106, please do as following:

RX Frequency	440.625MHz
TX Frequency	430.625MHz
RX CTCSS	100.0Hz
TX DCS	250.3Hz
RF Power	High
Bandwidth	Wide
PTT-ID	OFF

- 1.We have to check whether there are any data in CH106 or not. Come to MENU 28, if there is a 'CH' before '106', that means there are data. So please delete it and you will find there is not a 'CH' before '106', or else you can't have new data in this channel.
- 2.Press and hold [MENU] key, then power on, come to VFO mode. Press [EXIT/AB] key to select frequency A (UP).
- 3.Enter 440.625MHz

4. Now through the MENU, you can set other parameters. CTCSS, DCS, RF Power, Bandwidth, etc.
 5. After you finish all the other settings, press [MENU] key, then come to MENU 27, press [MENU] key two times, you will know all the data have been stored into CH106, however now only RX frequency was stored. At the same time, you press [MENU] key another two times,

Note:

- If you want the TX frequency 430.625 stored into CH106, you should do the same steps after you store the RX frequency into CH106.

9. CTCSS/DCS SCANNING

Before setting the CTCSS/DCS scanning, you should have a RX frequency and cancel the Dual Standby function, ensure the radio is working under VFO mode.

Come to MENU 11, press [MENU] one time, then press [*/SCAN] key, at the same time, you should press the PTT of another radio, then you will see the CTCSS scanning automatically. When the scanning stops, that means you find the same CTCSS as that of another radio, now press [MENU] to store the CTCSS.

10. REPEATER TAIL TONE

We all know that repeaters receive on one frequency and simultaneously retransmit that same information on a different frequency. We hear the courtesy tone almost every time we use the repeater. It's that innocuous beep that lets us know that the repeater is alive and, most importantly, that it has heard us. The MENU 35, 36, 37 are very helpful settings while your radio work through repeater. MENU 35 and MENU 36 better be set OFF. The parameter of MENU 37 is from 1-10, better set 5.

Sound-Light Alarm/ Cancel the alarm

There are 3 alarm modes in this radio, Alarm, Sending alarm code, sending the background sound. Press [SOS] alarm function, the radio will sound the alarm sound, the light flashes also. Press [SOS] again to stop the alarm.

When the radio is in emergency alarm, there are only [PTT] and SOS key workable. Press [PTT] to transmit, when the radio receive the transmit the alarm will stop also.

11. CTCSS/DCS:

In some cases only want to establish communications in a closed user group at a particular frequency or channel, for it will use "CTCSS" or code "DCS" for reception.

The "squelch" opens only when receiving a frequency with "CTCSS" or codes "DCS" same as the programmed in your transceiver. If codes of the received signal differs from those programmed in your transceiver, the "squelch" will not open and the received signal can be heard.

Note:

- The use of "CTCSS" or "DCS" in a communication, does not guarantee complete confidentiality communication.

CTCSS TABLE:

Nº	Tone (Hz)	Nº	Tone (Hz)	Nº	Tone (Hz)	Nº	Tone (Hz)	Nº	Tone (Hz)
1	67.0	11	94.8	21	131.8	31	171.3	41	203.5
2	69.3	12	97.4	22	136.5	32	173.8	42	206.5
3	71.9	13	100.0	23	141.3	33	177.3	43	210.7
4	74.4	14	103.5	24	146.2	34	179.9	44	218.1
5	77.0	15	107.2	25	151.4	35	183.5	45	225.7
6	79.7	16	110.9	26	156.7	36	186.2	46	229.1
7	82.5	17	114.8	27	159.8	37	189.9	47	233.6
8	85.4	18	118.8	28	162.2	38	192.8	48	241.8
9	88.5	19	123.0	29	165.5	39	196.6	49	250.3
10	91.5	20	127.3	30	167.9	40	199.5	50	254.1

DCS TABLE:

Nº	Code	Nº	Code	Nº	Code	Nº	Code	Nº	Code
1	D023N	22	D131N	43	D251N	64	D371N	85	D532N
2	D025N	23	D132N	44	D252N	65	D411N	86	D546N
3	D026N	24	D134N	45	D255N	66	D412N	87	D565N

4	D031N	25	D143N	46	D261N	67	D413N	88	D606N
5	D032N	26	D145N	47	D263N	68	D423N	89	D612N
6	D036N	27	D152N	48	D265N	69	D431N	90	D624N
7	D043N	28	D155N	49	D266N	70	D432N	91	D627N
8	D047N	29	D156N	50	D271N	71	D445N	92	D631N
9	D051N	30	D162N	51	D274N	72	D446N	93	D632N
10	D053N	31	D165N	52	D306N	73	D452N	94	D645N
11	D054N	32	D172N	53	D311N	74	D454N	95	D654N
12	D065N	33	D174N	54	D315N	75	D455N	96	D662N
13	D071N	34	D205N	55	D325N	76	D462N	97	D664N
14	D072N	35	D212N	56	D331N	77	D464N	98	D703N
15	D073N	36	D223N	57	D332N	78	D465N	99	D712N
16	D074N	37	D225N	58	D343N	79	D466N	100	D723N
17	D114N	38	D226N	59	D346N	80	D503N	101	D731N
18	D115N	39	D243N	60	D351N	81	D506N	102	D732N
19	D116N	40	D244N	61	D356N	82	D516N	103	D734N
20	D122N	41	D245N	62	D364N	83	D523N	104	D743N
21	D125N	42	D246N	63	D365N	84	D526N	105	D754N

SHORTCUT MENU OPERATION:

- 1.Press the key MENU,then press the key [▲] or [▼] to select the desired menu.
- 2.Press the key MENU again, come to the parameter setting.
- 3.Press the key [▲] or [▼] to select the desired parameter.
- 4.Press the key MENU to confirm and save, press the key EXIT to cancel setting or clear the input.

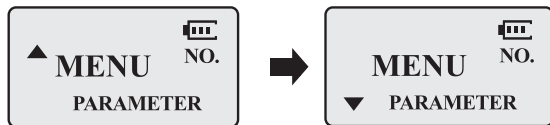

Note:

- Under channel mode, the following menu settings are invalid: CTCSS,DCS,W/N,PTT-ID,BCL, SCAN ADD TO,S-CODE,CHANNEL NAME. Only the H/L power could be changed by pressing #↵.

SET MENU DESCRIPTION:

Menu	Function/Description	Available settings
0	SQL (Squelch level)	0-9
1	STEP(Frequency step)	2.5/5/6.25/10/12.5/20/25/50kHz
2	TXP(Transmit power)	HIGH/MID/LOW
3	SAVE(Battery save,1:1/1:2/1:3/1:4)	OFF/1/2/3/4
4	VOX(Voice operated transmission)	OFF/1-10
5	W/N(Wideband/narrowband)	WIDE/NARR
6	ABR(Display illumination)	OFF/1/2/3/4/5s
7	TDR(Dual watch/dual reception)	OFF/ON
8	BEEP(Keypad beep)	OFF/ON
9	TOT(Transmission timer)	15/30/45/60.../585/600seconds
10	R-DCS(Reception digital coded squelch)	OFF/D023N...D754I
11	R-CTS(Reception Continuous Tone Coded Squelch)	67.0Hz...254.1Hz
12	T-DCS(Transmission digital coded squelch)	OFF/D023N...D754I
13	T-CTS(Transmission Continuous Tone Coded Squelch)	67.0Hz...254.1Hz
14	VOICE(Voice prompt)	OFF/ON
15	ANI(Automatic number identification of the radio,only can be set by PC software.	
16	DTMFST(The DTMF tone of transmitting code.)	OFF/DT-ST/ANI-ST/DT+ANI

17	S-CODE(Signal code, only could be set by PC software.)	1,.....,15 groups
18	SC-REV(Scan resume method)	TO/CO/SE
19	PTT-ID(press or release the PTT button to transmit the signal code)	OFF/BOT/EOT/BOTH
20	PTT-LT(delay the signal code sending)	0,.....,30ms
21	MDF-A(under channel mode, A channel displays. Note:name display only can be set by PC software.)	FREQ/CH/NAME
22	MDF-B(under channel mode, B channel displays. Note:name display only can be set by PC software.)	FREQ/CH/NAME
23	BCL(busy channel lockout)	OFF/ON
24	AUTOLK(keypad locked automatically)	OFF/ON
25	SFT-D(direction of frequency shift)	OFF/+/-
26	OFFSET(frequency shift)	00.000...69.990
27	MEMCH(stored in memory channels)	000,...127
28	DELCH(delete the memory channels)	000,...127
29	WT-LED(illumination display color of standby)	OFF/BLUE/ORANGE/PURPLE
30	RX-LED(illumination display color of reception)	OFF/BLUE/ORANGE/PURPLE
31	TX-LED(illumination display color of transmitting)	OFF/BLUE/ORANGE/PURPLE
32	AL-MOD(alarm mode)	SITE/TONE/CODE
33	BAND(band selection)	VHF/UHF
34	TX-AB(transmitting selection while in dual watch/ reception)	OFF/A/B

35	STE(Tail Tone Elimination)	OFF/ON
36	RP_STE(Tail tone elimination in communication through repeater)	OFF/1,2,3...10
37	RPT_RL(Delay the tail tone of repeater)	OFF/1,2,3...10
38	PONMGS(Boot display)	FULL/MGS
39	ROGER(tone end of transmission)	ON/OFF
40	A/B-BP(Tone end of reception)	OFF/A/B
41	RESET (Restore to default setting)	VFO/ALL

Reset(Restore To Default Setting)

The transceiver has a menu which resets VFO and ALL message. When you use RESET VFO, all parameter will be return to factory default. When you use RESET ALL, all transceivers and channel parameter will be return to factory default.

In standby, press [MENU]+[Number Key 40], and then screen will display "RESET". Press [MENU] enter, press [UP] or [DOWN] to select the desired work mode VFO or ALL. Press [MENU] to confirm, then press [EXIT] to return to standby.

COPYING

The following step to copy Radio A to Radio B.

- 1) Connecting the two radios with special data cable.
 - 2) Turn on the radio B on
 - 3) Press [MONI] at the meantime, turn on the radio A, the screen showing COPYING, when the copy finished, Radio B will power off auto and power on auto.
- Repeat the above 2 and 3 steps to clone more radios, if you can not clone successful, please turn off both A and B eadio, and make sure they were connected correctly with clone cable

TECHNICAL SPECIFICATION:**1.GENERAL:**

Frequency range:	65MHz-108MHz(Only commercial FM radio reception). VHF:136MHz-174MHz (Rx/Tx). UHF:400MHz-520MHz (Rx/Tx).
Memory channels:	Up to 128 channels
Frequency stability:	2.5ppm.
Frequency step:	2.5kHz/5kHz/6.25kHz/10kHz/12.5kHz/20/kHz/25kHz.
Antenna impedance:	50 Ω .
Operating temperature:	-20°C to +60°C.
Supply voltage:	Rechargeable Lithium-Ion mAh 7.4V/1800.
Consumption in reception:	380mA
Consumption in transmission:	≤1.4 A.
Mode of operation:	Simplex or semi-duplex.
Duty cycle:	03/03/54 min. (Rx / Tx / Standby).
Dimensions:	58mm x 110mm x 32mm
Weight:	510 g (approximate).

2.TRANSMITTER:

RF power:	5W/1W.
Type of modulation:	FM.
Emission class:	16KΦF3E/11KΦF3E (W/N).
Maximum deviation:	≤±5 kHz/≤±2.5 kHz (W/N).
Spurious emissions:	<-60 dB.

3. RECEIVER:

Receiver sensitivity:	0.2 μ V(at 12 dB SINAD).
Intermodulation:	60 dB.
Audio output:	1W
Spurious Radiation:	≧ 65dB

Note:

- All specifications shown are subject to change without notice.

TROUBLESHOOTING:

Problem	Possible cause / solution
The radio does not start.	The battery is low, replace the battery with a charged battery or proceed to the battery. The battery is not installed correctly, remove the battery and reattach it.
The battery runs down quickly.	The battery life has come to an end, replace the battery with a new one. The battery is fully charged, make sure the battery is made in full.
The receiving indicator LED lights but do not hear the speaker.	Make sure the volume setting is too low. Make sure the undertones "CTCSS" or code "DCS" are the same as those programmed in the transceiver of the other members of your group.
When transmitting, the other members of his group do not receive the communication.	Make sure the undertones "CTCSS" or code "DCS" programmed in your transceiver are the same as those programmed in the transceiver of the other members of your group. Your partner or you, are too far. You or your partner are in a bad area of RF signal propagation.

In "standby" mode, the transceiver transmits without pressing the "PTT".	Check the level adjustment function "VOX" is not set too sensitive.
Receive communications from other user groups while communicating with your group.	Change frequency or channel. Change the undertones "CTCSS" or code "DCS" in your group.
Communication with other members of your group is poor or low quality.	You or your partner is too far away or in an area of poor radio signal propagation, such as inside a tunnel, inside an underground car park, in a mountainous area, including large metal structures, etc..
Once these checks, if you still have problems with the transceiver, check with your distributor, dealer or service center.	

WARRANTY: (Better buy the radios from local dealer).

WARRANTY CERTIFICATE		
Brand:	Model no.:	Serial no.:
Name of purchaser:		
Address:		Seal and name of the dealer:
City:	Zip code:	
Province/State:	Tel no.:	
Date of purchase:		
WARNING: Warranty is valid provided it is complete and properly filled in legibly and clearly present the seal and name of the dealer and have attached the bill proof of purchase of equipment.		

The device described in this Certificate is guaranteed for a period of TWO YEARS from the date of sale to the final user. This Warranty Certificate is unique and not transferable and may not be reissued for new or original or copy. Substitution of product failure or any part thereof shall not involve extension of the guarantee.

The warranty covers the replacement and free replacement of all parts that are defective in materials and components used in manufacturing and / or assembly of the apparatus.

The warranty does not cover any faults caused by accident, improper installation and use, electric shock (eg storms), connect a power other than that specified, reverse polarity in the diet, or claims due to deterioration in the external appearance of normal use, nor the amount or condition of the accessories.

Checking the accessories is the responsibility of the purchaser at the time of purchasing the device.

The warranty does not cover rechargeable batteries even if they are part of the equipment purchased as they are considered consumables, the impairment must be reported within a period of fifteen days from the date of purchase.

The warranty is void on the following assumptions:

- 1.Devices that have been manipulated by another or by anyone other than authorized service provider.
- 2.Equipment and accessories in which the serial number has been altered, deleted or filed unreadable.
- 3.Use of the product than as intended.

To make use of the guarantee is necessary to give the dealer or any of the Authorised Service the defective device with its accessories and the following documentation:

- (1).Warranty Certificate duly completed and sealed.
- (2).Original invoice which clearly identifies the device and the date of purchase.
- (3).Description of the faults.

The warranty terms contained in this Certificate of Guarantee do not exclude, modify or restrict the statutory rights of the buyer by virtue of the laws in force at the time of purchase, but are added to them.