

# How to Use Your Cobra 25 LX

Contents	
Features	1
The CB Story	A1
FCC Regulations, FCC Warnings & Included Accessories	
Controls & Indicators	A2
Our Thanks to You	A3
Customer Support	
Installation	
Location & Mounting/Connection	2
Antennas	
CB Antenna & Marine Installation	6
Ignition Noise Interference	7
Operating Your 25 LX	
Turning On Your CB	8
Setting Channel Selector	9
To Receive	10
Selecting a Channel	10
S-Meter	11
To Transmit	12
Setting Dynamike®	13
Menu Mode	14
Setting the Clock	15
Setting the Alarm	15
Setting the Count Down Timer	16
Setting Display Color Mode	17
Setting Brightness Mode	18
Setting Contrast Mode	18
Key Tones Mode	19
Radio Check Mode	19
Software Version/Factory Settings	20
NB/Off (Noise Blanker/Automatic Noise Limiter Switch)	21
RF Gain Control	21
Program Memory Channels	22
Scan CB Channels	23
Scan/Memory Scan	23
Scan Memory Channels	23
Dimmer Control	23
Setting Squelch	24
S/RF Meter	26
External Speaker	27
PA (Public Address)	28
Home And Office Set-Up	30
Temporary Mobile Set-Up	31
How Your CB Can Serve You	32
A Few Rules You Should Know	32
Channel 9 Emergency Messages	32
CB 10 Codes	34
Frequency Ranges	36
25 LX Specifications	37
Warranty Information	38
Optional Accessories	39
If You Need Service/Trademark Info	Back Cover

## Features of This Product

- Selectable 4-Color LCD Display
- 40 CB Radio Channels
- 40 Channel Scan
- Memory Channels
- Channel Frequency Read-Out
- Radio Check Diagnostic
- Clock/Timer/Alarm
- Heavy-Duty Dynamic Microphone
- Full 4 Watts AM RF Power Output
- Instant Channel 19 and 9
- Front Panel 4-Pin Microphone Connector
- Switchable Noise Blanker
- Adjustable Dynamike Boost
- Tactile Controls
- 9 Ft Mic Cord
- Programmable Dimmer Control
- RF Gain

## Location

### Location

Plan location of transceiver and microphone bracket before starting the installation.

Select a location that is convenient for operation, yet does not interfere with the driver or passenger.

The transceiver is usually mounted to the underside of the dash with the microphone bracket beside it.

## Mounting and Connection

### Note

The transceiver is held in the universal mounting bracket by two thumbscrews which allow for adjustment at a convenient angle.

The bracket includes two self-tapping screws and star washers. The mounting must be mechanically strong, conveniently located.

### Mounting and Connection

- 1 Hold the radio with the mounting bracket in the exact desired location. If there is no interference, remove the bracket and use it as a template to mark the location for the mounting screws.

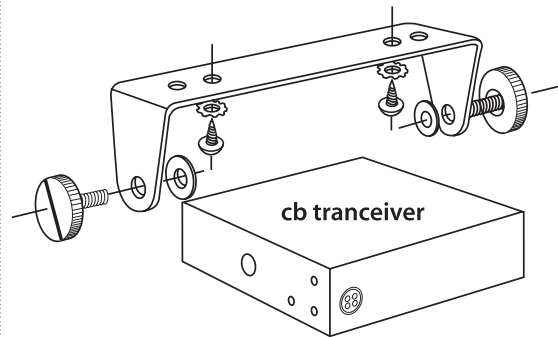

- 2 Drill the holes and secure the bracket.

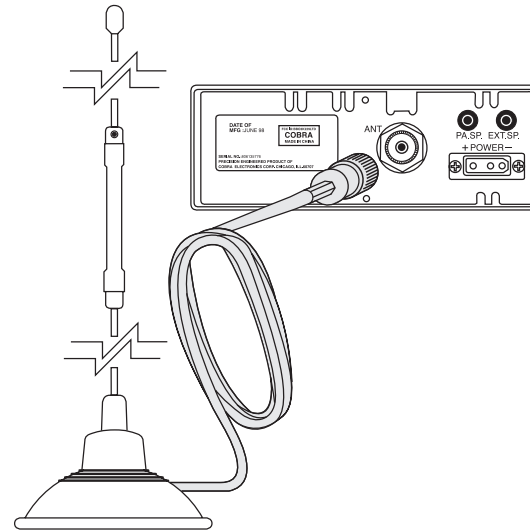

- 3 Connect the antenna cable plug to the receptacle marked "ANT" on the back of the unit.

continued

# Installation

## Note

Before installing the CB radio, visually check the vehicle's battery connection to determine which terminal, positive or negative, is grounded (positive is the larger of the two) to the engine block (or chassis). A negatively grounded vehicle has its negative lead grounded to the chassis.

## Note

Connecting the radio to an accessory fuse prevents the unit from being left on accidentally, and also permits operating the unit without running the engine.

## Note

The radio should be connected to a constant 12V source to maintain the time when the radio is turned off.

## Note

When connected to an accessory fuse, unit will self test automatically when ignition is turned on. Turns itself on & off.

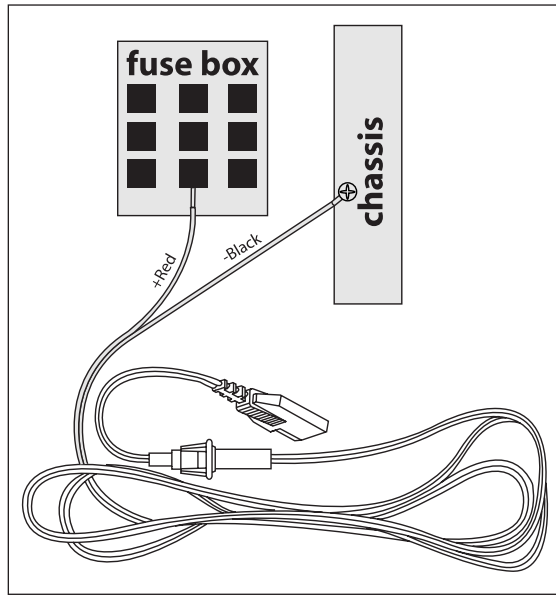

- 4 In a negative grounded vehicle, connect the red lead of the DC power cord to an accessory 12 volt fuse.
- 5 Connect the black lead to the negative side of the vehicle. This is usually the chassis. Any convenient location with a good electrical contact (remove paint) may be used.

# Installation

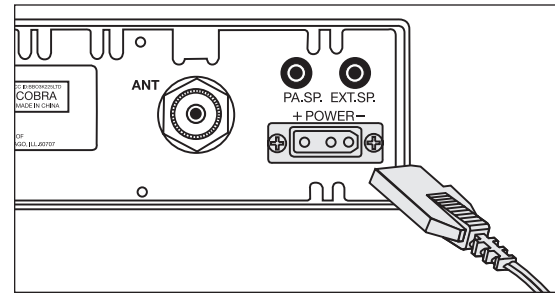

- 6 Plug power cable into back of unit marked "Power". Be sure to observe polarity markings.
- 7 Mount the microphone bracket on either side of the unit (driver's left) using two screws supplied. Bracket should be placed under the dash so microphone is readily accessible.

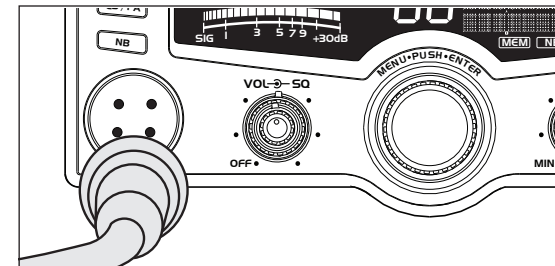
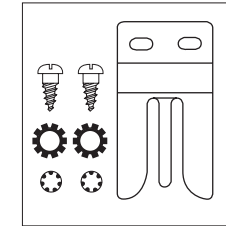

- 8 Attach the 4-pin microphone cable to receptacle on front of unit and install unit in bracket securely.

## Note

If microphone is not connected, audio will not be heard at speaker.

## CB Antenna

### Note

For optimum performance in passenger cars the ideal antenna location is on the center of the roof. Second choice is on the center of the trunk.

### Note

Because many newer trucks feature fiberglass door skins, the outside mirror must be grounded to the chassis via a ground strap, if the antenna is mounted on the mirror bracket.

### Note

3-way Combination Antennas are also available which allow operation of all three bands (AM-FM & CB), using a single antenna. However, this type of antenna usually results in less than normal transmit and receive range when compared to a standard-type "Single Band" CB antenna. Call 773-889-3087 for further information.

## CB Antenna

Since the maximum allowable power output of the transmitter is limited by the FCC, the antenna is critical in affecting transmission distance. Only a properly matched antenna system will allow maximum power output. Cobra loaded type antenna models are highly recommended for most installations. **For models with Weather Feature (WX), a Dual Band (Center Load/Base Load) antenna is recommended.** Consult your Cobra dealer for further details, or call 773.889.3087 and speak to a Cobra representative.

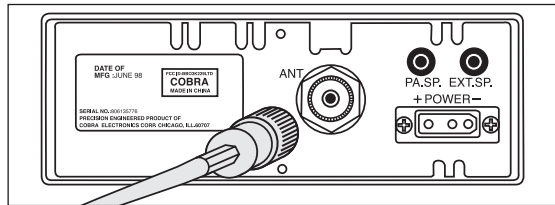

- 1 A standard antenna connector is provided on the transceiver for easy connection.

## Marine Installation

The transceiver will not operate at maximum efficiency in a boat without a ground plate, (unless it has a steel hull). Before attempting installation, consult your dealer for information regarding an adequate grounding system and prevention of electrolysis between fittings in the hull and water.

Use of a mobile receiver at low signal levels is normally limited by the presence of electrical noise. The primary source of noise in automobiles is from the alternator and ignition system. Typically, when signal level is adequate, the background noise does not present a serious problem. Also, when extremely low level signals are being received, the transceiver may be operated with the vehicle's engine turned off. The unit requires very little current and therefore will not significantly discharge the vehicle's battery.

Even though the Cobra 25 LX has an automatic noise limiter, in some installations ignition interference may be high enough to make good communications impossible. Many possibilities exist and variations between vehicles require different solutions. Consult your Cobra dealer or a 2-way radio technician for help in locating the source of a severe noise.

## Turning On

### Turning On

Make sure the power cord, antenna and microphone are connected to their proper connectors before starting.

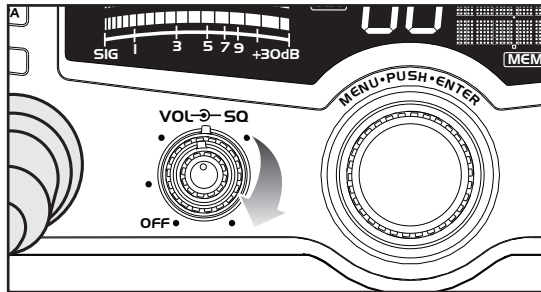

- 1 Rotate the **On/Off Volume** knob *clockwise* to turn unit on and adjust to a normal listening level.

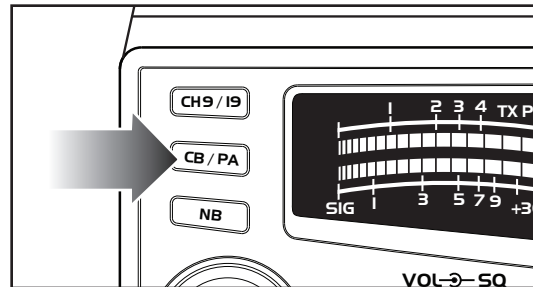

- 2 Press the **CB/PA** button to change modes.

## Setting Channel Selector

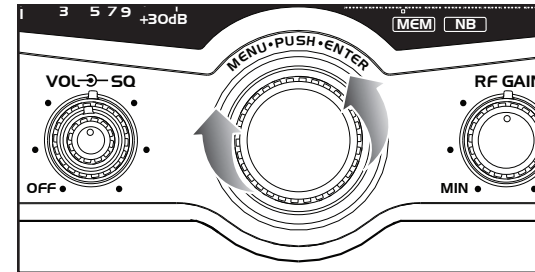

- 3 Select one of forty channels and adjust volume. The selected channel (1 through 40) will be indicated by the readout directly above the channel selector knob

## Setting Channel Selector

### Note

Press **CB/PA** to select **CB** or **PA** (public address) mode.

## To Receive

### To Receive

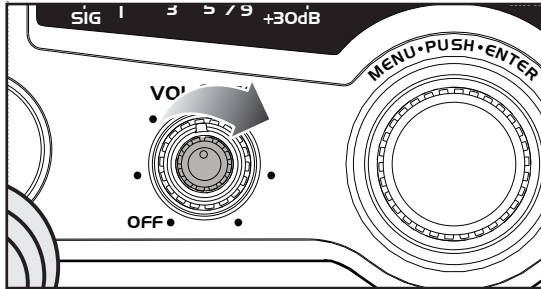

- 1 Rotate the **On/Off Volume** knob *clockwise*. The RX icon will be displayed.

## Selecting A Channel

### Selecting A Channel

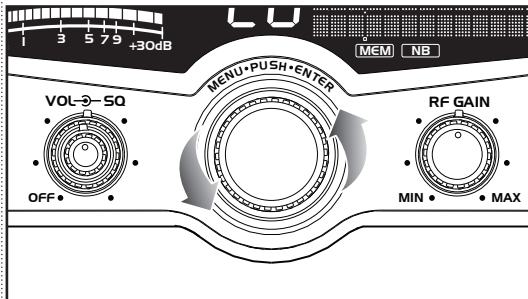

- 1 Unit should be in CB mode. Rotate **channel selector** *clockwise* or *counter-clockwise* to select desired channel.

### S-Meter

Swings proportionately to strength of incoming signal when receiving.

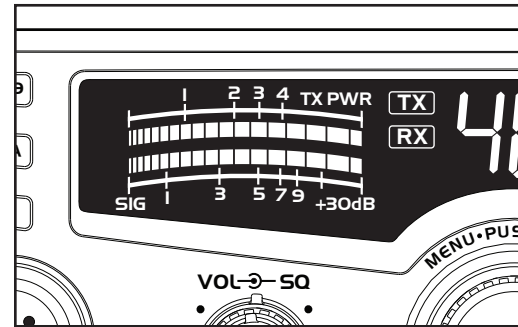

### S-Meter

## To Transmit



### Caution!

Be sure the antenna is properly connected to the radio before transmitting. Prolonged transmitting without an antenna, or a poorly matched antenna, could cause damage to the transmitter.

Be sure to read the F.C.C. Rules and Regulations included with this unit before transmitting.

## To Transmit

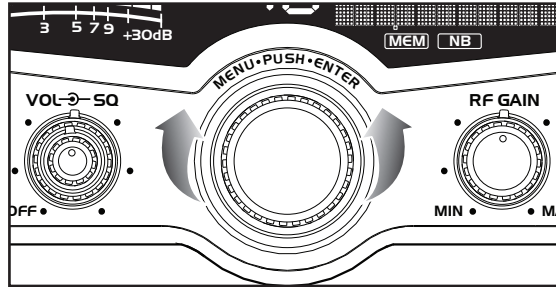

- 1 Select desired channel.

## Transmit

**PUSH & HOLD**

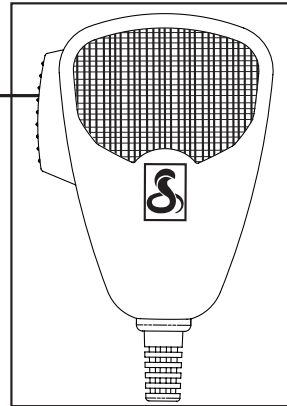

- 2 Push and hold mic button to transmit. Transmitter is now activated. When transmitting, hold the microphone two inches from your mouth and speak in a clear, normal voice. Release to receive.

## Setting Dynamike®

This controls the microphone sensitivity (outgoing audio level).

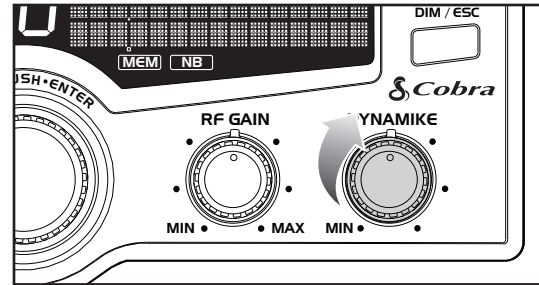

- 3 Initially, set fully *clockwise* so that maximum voice volume is available. Dynamike may have to be reduced in some conditions.

## Setting Dynamike®

# Operation

## Menu Mode

### Note

Use Dim/Escape button to exit from any routine back to CB standby mode.

## Menu Mode

Used to program special features. **Menu/Enter** knob is used to move cursor to desired feature to program.

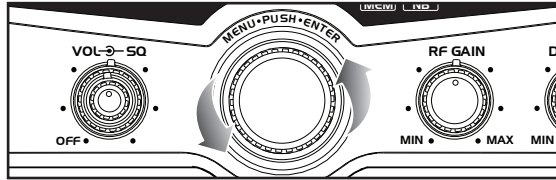

Rotate **Menu/Enter** knob *clockwise* to navigate menu levels.

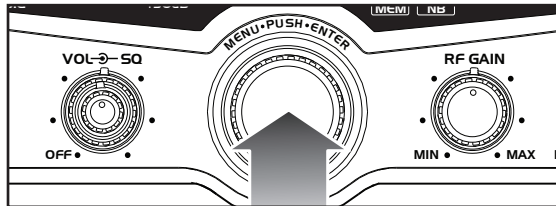

Press **Menu/Enter** knob to select feature to be programmed.

### Level 1:

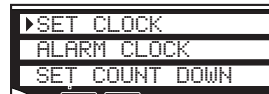

### Level 2:

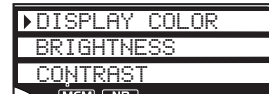

### Level 3:

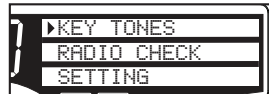

### Level 4:

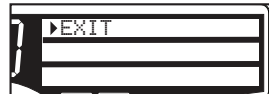

# Operation

## Setting the Clock

### Setting the Clock

Using the clock, alarm and countdown functions. To set the clock, press **Menu/Enter** knob and select **Set Clock**.



**12:00 PM** will appear in the display and the hours will flash. Rotate **Menu/Enter** knob *clockwise* to select desired hour and press to set.

The minutes will then flash. Rotate **Menu/Enter** knob again to select desired minutes and press to set.

Once the minutes are set, AM or PM will then flash. Rotate **Menu/Enter** knob again to select **AM** or **PM** and press to set or scroll down to **EXIT** and press to return to main menu.

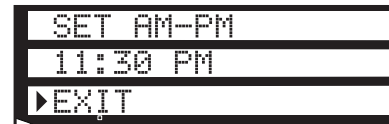

### Setting the Alarm

Your 25 LX can be utilized as an alarm clock. To set the alarm, press **Menu/Enter** knob and select **Set Alarm**.

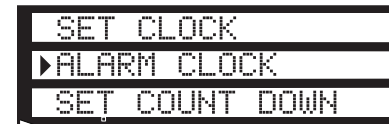

Rotate **Menu/Enter** knob *clockwise* to select **Set Alarm Time**. Follow instructions above for setting the alarm time and AM or PM.

### Note

Normal display will appear if clock has not yet been set.

### Note

Use Dim/Escape button to exit from any routine back to CB standby mode.

### Note

The radio should be connected to a constant 12V source to maintain the time when the radio is turned off.

## Setting the Alarm



# Operation

## Setting the Alarm *continued*

### Note

Default snooze time length is 10 minutes.

### Note

Press Dim/Escape button to return to CB standby mode.

### Note

Default alarm length is 60 seconds and is set in 10 second increments.

## Setting the Count Down Timer

### Note

Press Dim/Escape button to return to CB standby mode.

Once alarm settings are complete, rotate **Menu/Enter** knob *clockwise* to **Set Snooze** and press to select.



Enter desired snooze time (from 1 to 60 minutes). Select **Enter** to exit, return to Set Snooze or Alarm Length. Select Alarm Length to set alarm duration (from 10 to 300 seconds). Pressing **Menu/Enter** knob returns unit to exit, Set Snooze or Alarm Length.

### Setting the Count Down Timer

To set the count down timer, press **Menu/Enter** knob and select **Set Count Down**.



Follow instructions in **Setting the Clock** section (page 17) to set count down hour and minutes. Once desired count down time is selected, press **Menu/Enter** knob again to set and return to the standby menu.

# Operation

## Setting Display Color Mode

### Setting Display Color Mode

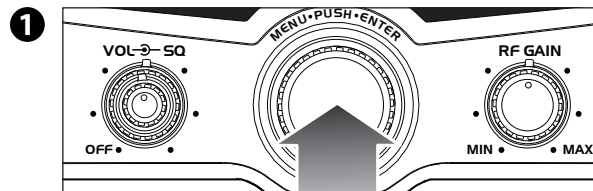

Press **Menu/Enter** knob and scroll down to select **Display Color**.



Press and release **Menu/Enter** to set the color.

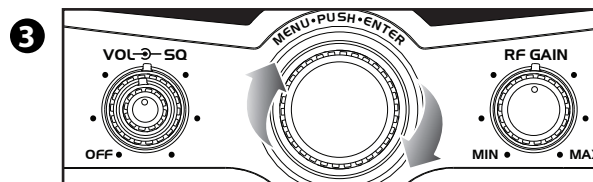

Rotating **Menu/Enter** knob *clockwise* changes the display color from green to blue to amber to red then back to green.



Press **Menu/Enter** knob or escape button again to exit routine.

### Note

Select **EXIT** to return to main menu. Press Dim/Escape button to return to CB mode.

# Operation

# Operation

## Setting Brightness Mode

### Note

If an attempt is made to exceed the highest or lowest brightness levels, 1 error beep will be heard.

### Note

Exit will return to menu mode. ESC will exit and return to CB Standby.

### Note

To select day or night levels, press and release Dim/Escap button once levels are set.

### Note

To toggle from day to night settings, see page 27.

## Setting Brightness Mode

Press **Menu/Enter** knob to select **Set Brightness**



Rotate **Menu/Enter** knob *clockwise* to **Select Brightness**. Press **Menu/Enter** knob to select **Day-Bright**. Turn **Menu/Enter** *clockwise* to increase brightness and turn *counter-clockwise* to decrease brightness.



To set the day bright level, turn the **Menu/Enter** knob *clockwise* to a desired setting and then press **Menu/Enter**. To set the **Night-Dim** level, repeat instructions above then select **Night-Dim**.



Press **Menu/Enter** knob again to exit routine.

## Setting Contrast Mode

Press **Menu/Enter** knob and rotate *clockwise* to select **Set Contrast**. Press **Menu/Enter** knob again and rotate *clockwise* to increase contrast, *counter-clockwise* to decrease contrast. Press **Menu/Enter** knob to set contrast.



Press **Menu/Enter** knob again to exit routine.

## Key Tones Mode On and Off

Press **Menu/Enter** knob and rotate *clockwise* to **Set Key Tones**. Press **Menu/Enter** to set Key Tones **On/Off**.



Press **Menu/Enter** knob to select **On/Off** and exit to main menu.

## Radio Check Mode

Allows testing of important radio functions.

**Test 1- Battery Level:** Confirms that battery voltage level is between 10.8 V to 15.8 V. If in that range, it is "PASS". Outside of that range, either FAIL LOW" or "FAIL HIGH" will be displayed. Press **Menu/Enter** knob to advance to next test.

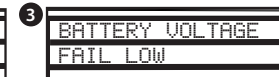
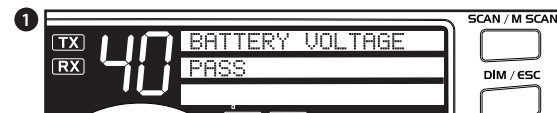

**Test 2- RF Power Output:** Confirms 3.3 to 4 Watt output level. Once Push-to-Talk button is pressed, Pass or Fail will be displayed if level is outside limits.

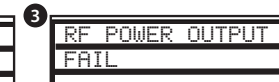
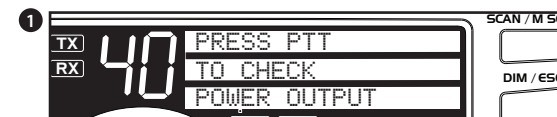

## Key Tones Mode

### Note

Press Dim/Escap button to return to CB mode.

## Radio Check Mode

### Note

Press Dim/Escap button to return to CB standby mode. If 10 seconds pass or if Enter button pressed, unit goes to 2nd test.

### Note

Press Push-To-Talk within 10 seconds or unit will go to the next test.

### Note

Press Dim/Escap button to return to CB standby mode. If 10 seconds pass or if Enter button pressed, go to 3rd test.

### Note

Press Dim/Escap button to return to CB standby mode. If 10 seconds pass or if Enter button pressed, testing is complete. Unit will return to CB Standby mode.

# Operation

## Software Version/Factory Settings

**Note**  
Default display color is green.

**Software Version/Factory Settings**  
Displays current software version and returns unit to original factory settings. To view software version, rotate **Menu/Enter** knob *clockwise* to select **Setting** then **Software Version**.

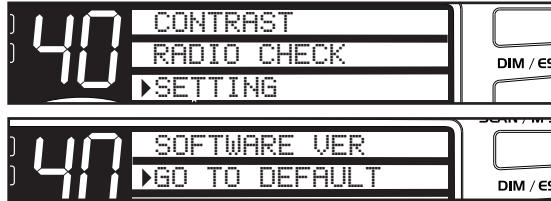

To restore default settings, Press **Menu/Enter** knob again. Rotate **Menu/Enter** knob *clockwise* to select **Setting** then **Go To Default**.

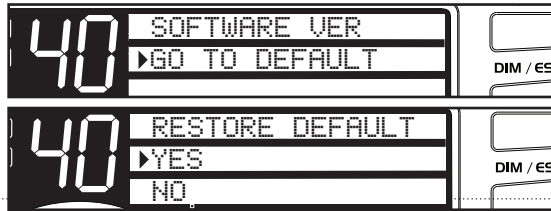

Press **Menu/Enter** knob to restore default settings. Choose **NO** to maintain present setting with no change.

# Operation

## NB OFF Button

**Note**  
The RF noise blarker is very effective in reducing repetitive noises such as ignition interference.

## NB/OFF Button

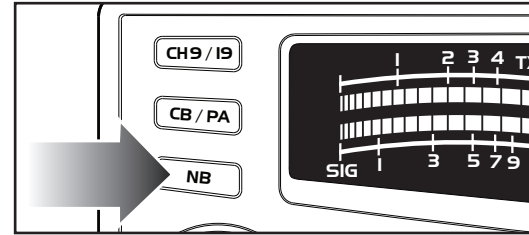

- 1 When switched to NB mode the RF Noise Blanker is activated, providing increased noise filtration. When switched to OFF mode all noise filtration will be turned off.

## RF Gain Control

The RF Gain is used to optimize reception in strong or weak signal areas.

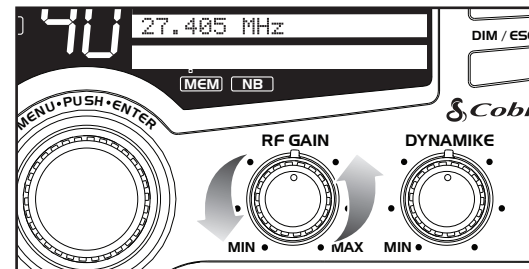

- 1 Rotate the RF Gain knob *counterclockwise* to reduce gain in strong signal areas. In weak signal areas turn *clockwise* to increase gain.

## RF Gain Control

**Note**  
The RF Gain is used to optimize reception in weak signal areas.

## Program Memory Channels

### Note

The radio should be squelched before scan features are activated.

### Note

Keying the microphone will stop the scan feature.

### Note

If more than 10 channels are attempted to be programmed, 3 error beeps will be heard and "Memory Full" will be displayed for 10 seconds or until any button is pushed.

### Note

To remove a channel from memory, go to the unwanted memory channel then press and hold the scan button until the MEM icon turns off.

## Program Memory Channels

Set first channel. Press and hold **Scan/MemScan** button. Memory icon will appear. Select second channel, press and hold **Scan/MemScan** button again until Memory icon appears. Repeat above steps to enter up to 10 channels in memory.

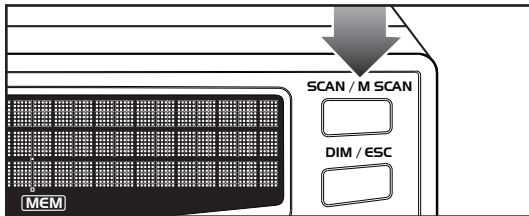
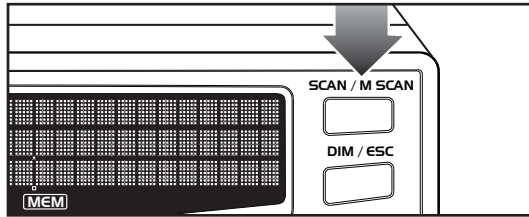

- 1 Pressing the **Scan/Memory Scan** button toggles from **Off** to **Scan All Channels** to **Memory Channel Only Scan** and back to **Off**.

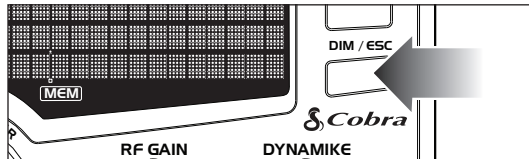

- 2 Press **Dim/Escape** button to end Scan and return to CB mode.

## Scan CB Channels

## Scan CB Channels

To scan all 40 CB channels, the unit must be squelched. Press and release **Scan/Mem Scan** button once.

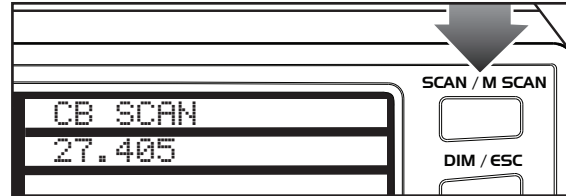

## Scan Memory Channels

To scan memory channels, press and release **Scan/Mem Scan** button twice.

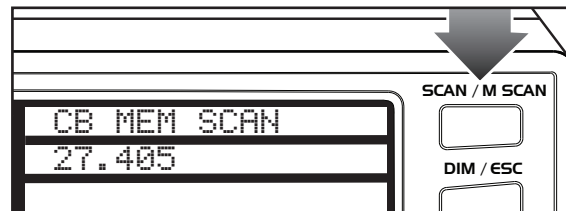

## Dimmer Control

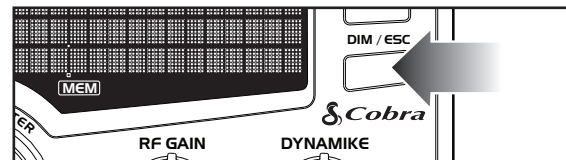

- 1 Press **Dim/Esc** button to toggle between day and night settings. See setting instructions on page 20.

## Scan Memory Channels

## Dimmer Control

## Setting Squelch

### Gate closed

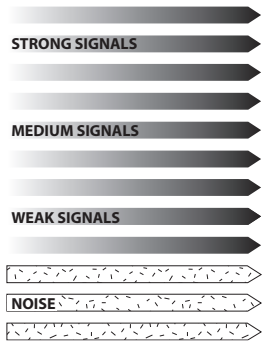

### Gate open

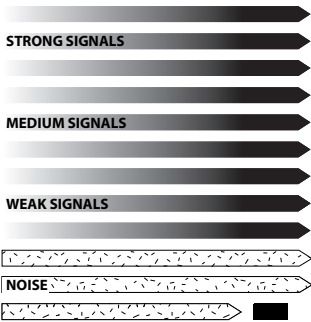

GATE  
OPEN

## Setting Squelch

Squelch is the “control gate” for incoming signals.

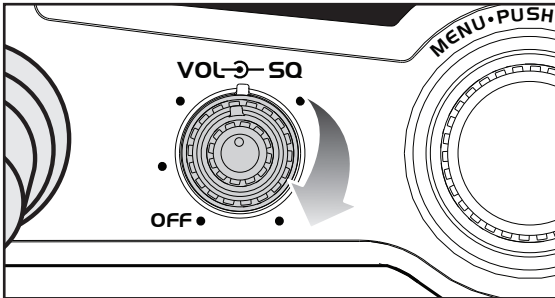

- 1 Full *clockwise* rotation closes the gate allowing only very strong signals to enter.

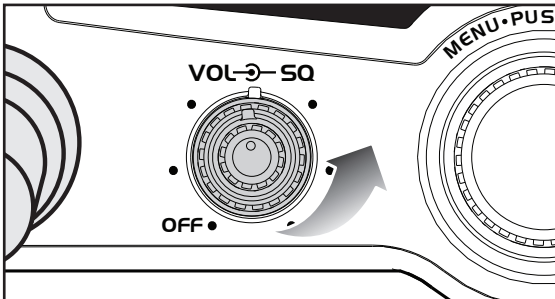

- 2 Full *counterclockwise* rotation opens the “gate” allowing all signals in.

## Setting Squelch

### Gate set to Desired Squelch Setting (DSS)

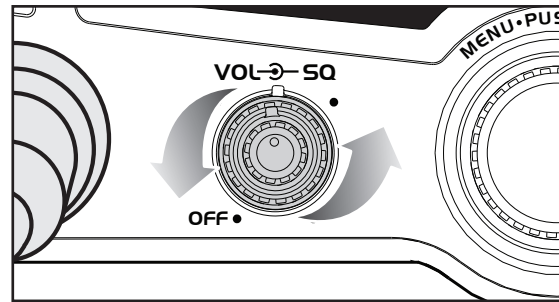
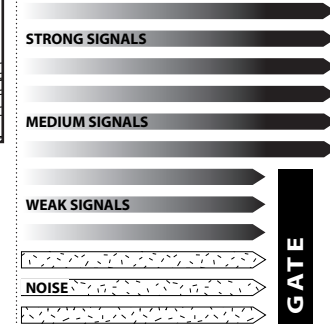

- 3 To achieve the Desired Squelch Setting (DSS), turn the Squelch control *counterclockwise* until you hear noise. Now turn the control *clockwise* just until the noise stops. This is the DSS setting.

# Operation

## S/RF Meter

### S/RF Meter

This meter swings proportionately to the RF output (outgoing signal) and incoming receive signal.

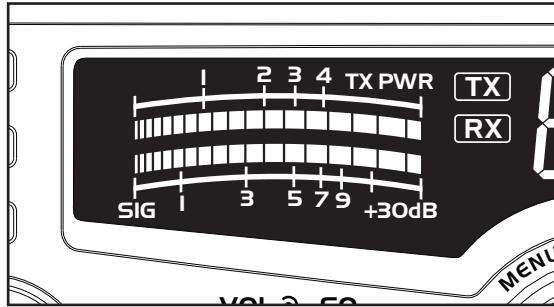

# Operation

## External Speaker

The external speaker jack is used for remote receiver monitoring.

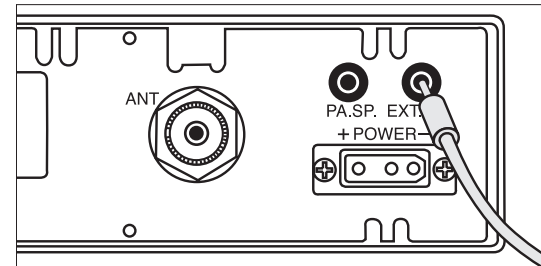

- 1 Connect an external speaker to the external speaker jack on the rear panel.

## External Speaker

### Note

The external speaker should have 8-ohm impedance and be rated to handle at least 4.0 watts. When the external speaker is plugged in, the internal speaker is automatically disconnected. See accessory page 43.

### Note

Cobra external speakers are rated at 10 watts.

## PA (Public Address)

### Note

Speaker should have 8-ohm impedance and be rated to handle at least 4.0 watts.

### Note

The speaker should be directed away from the microphone to prevent acoustic feedback.

### Note

Activity on the CB channel will be heard through the PA speaker. Adjust Volume Control to a normal listening level.

### PA (Public Address)

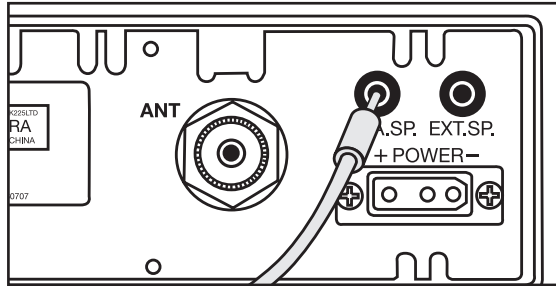

- 1 Connect an external PA speaker to the PA jack on the rear panel.

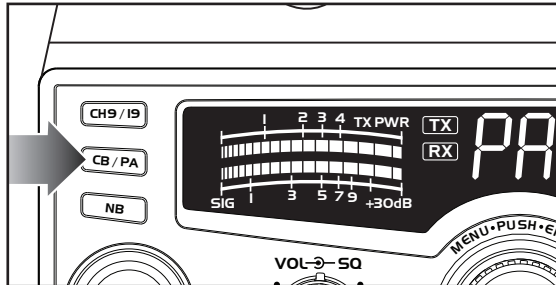

- 2 Press **CB/PA** button to select PA.

**PUSH & HOLD**

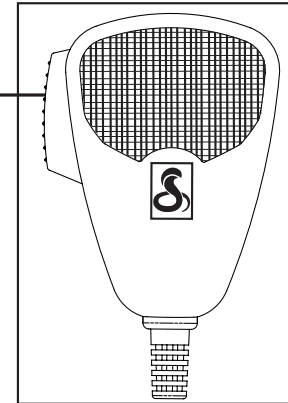

- 3 Push and hold microphone button and speak in a normal voice. Your voice will now transmit on the PA speaker.

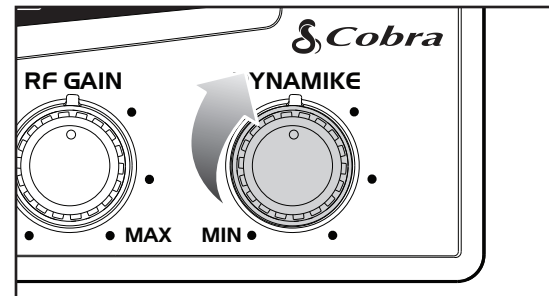

- 4 Adjust PA speaker volume with the **Dynamike®** control.

# Home And Office Set-Up

## Base Station Operation (From 120V AC House Current)

### Base Station Operation (From 120V AC House Current)

To operate your transceiver from home or office you will need a 13.2 volt DC Power Pack rated at a minimum of 2 amps, and a properly installed base station antenna.

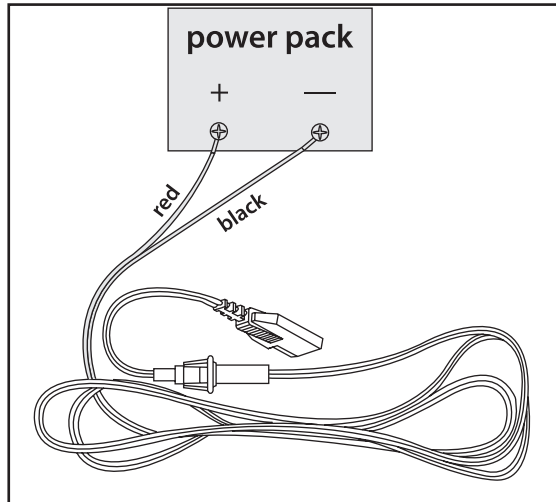

- 1 Simply connect the red (+) and black (-) leads of the transceiver to the corresponding terminals of the power pack.

# Temporary Mobile Set-Up

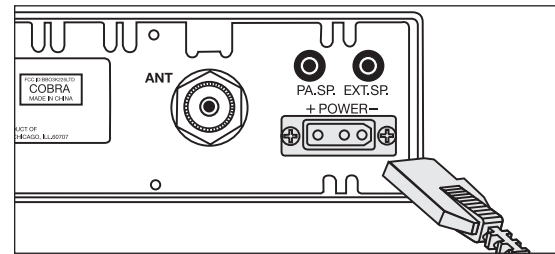

- 2 Plug power cable into back of unit marked "Power". Be sure to observe polarity markings.
- 3 Connect properly installed and matched base station antenna.

## Temporary Mobile Operation

For temporary mobile operation you may want to purchase an optional cigarette lighter adapter from your COBRA dealer. This adapter and a magnetic mount antenna allow you to quickly "install" your transceiver for temporary use.

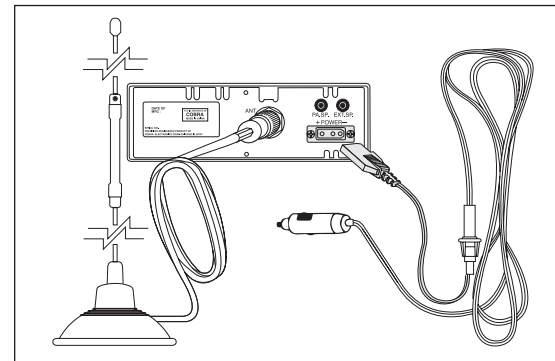

## Temporary Mobile Set-Up



**Warning!**  
Do not attempt to operate this transceiver by connecting it directly to 120V AC.

**Note**  
For further information call Cobra Customer Service 1.773.889.3087.



# How Your CB Can Serve You

## A Few Rules You Should Know

- Warn of traffic problems
- Provide weather and road data
- Provide help in event of an emergency
- Provide direct contact with home or office
- Assist police by reporting erratic drivers
- Get "local information" to find destination
- Communicate with family and friends
- Suggest spots to eat and sleep
- Keep you alert while traveling

### A Few Rules You Should Know

- A. Conversations cannot last more than 5 minutes with another station. A one minute break is required to let others use the channel.
- B. You cannot blast others off the air by use of illegally amplified transmitters or illegally high antennas.
- C. You cannot use CB to promote illegal activities.
- D. Profanity is not allowed.
- E. You may not transmit music with a CB.
- F. Selling of merchandise and/or services is prohibited.

### 1. Set to channel 9 for emergencies

Be sure antenna is properly connected.

### 2. CB Distress Data

When transmitting an emergency, you should request a "REACT BASE" and provide the CB distress data (called CLIP):

- |                   |                                      |
|-------------------|--------------------------------------|
| <b>C</b> all Sign | <i>Identify yourself.</i>            |
| <b>L</b> ocation  | <i>Be exact.</i>                     |
| <b>I</b> njuries  | <i>Number. Type. Trapped?</i>        |
| <b>P</b> roblem   | <i>Give details and help needed.</i> |

Transmit CLIP repeatedly so any monitor can assist.

## Channel 9 Emergency Messages

### Note

If no response on channel 9, try channels 19 or 14.

# How Your CB Can Serve You

The FCC gives these examples of permitted and prohibited messages for channel 9. These are only guidelines and not all-inclusive:

Permitted	Example Message
Yes	"Tornado sighted six miles north of town."
No	"Post number 10. No tornado sighted."
Yes	"Out of gas on I-95 at mile marker 211."
No	"Out of gas in my driveway."
Yes	"Four car accident on I-94 at Exit 11. Send police and ambulance."
No	"Traffic moving smoothly on I-94."
Yes	"Weather Bureau has issued thunderstorm warning. Bring sailboat into port."
No	"Attention motorists. Weather Bureau advises snow tomorrow will accumulate 4 to 6 inches."
Yes	"Fire in building at 539 Main, Evanston."
No	"Halloween patrol number 3. All quiet."

# How Your CB Can Serve You

## CB 10-Codes

Citizen Bands have adopted the "10-CODES" for standard questions and answers. These codes provide quick and easy communication, especially in noisy areas. Following are some of the more common codes and meanings:

Code	Meaning
------	---------

10-1	Receiving poorly
10-2	Receiving well
10-3	Stop transmitting
10-4	OK, message received
10-5	Relay message
10-6	Busy, stand by
10-7	Out of service, leaving
10-8	In service, subject to call
10-9	Repeat message
10-10	Transmission completed standing by
10-11	Talking too rapidly
10-12	Visitors present
10-13	Advise weather/roads
10-16	Make pick up at
10-17	Urgent business
10-18	Anything for us?
10-19	Return to base
10-20	My location is
10-21	Call by phone
10-22	Report in person to
10-23	Stand by
10-24	Completed last assignment
10-25	Can you contact
10-26	Disregard last info
10-27	Moving to channel
10-28	Identify your station

Code	Meaning
------	---------

10-25	Time is up for contact
10-30	Does not conform to FCC rules
10-33	Emergency traffic
10-34	Trouble at this station
10-35	Confidential information
10-36	Correct time is
10-37	Wrecker needed at
10-38	Ambulance needed
10-39	Message delivered
10-41	Turn to channel
10-42	Traffic accident at
10-43	Traffic tie up at
10-44	Have a message for
10-45	All units within range please report
10-50	Break channel
10-60	What is next message number?
10-62	Unable to copy. Use phone
10-63	Net directed to
10-64	Net clear
10-65	Awaiting your next message/assignment
10-67	All units comply
10-70	Fire at
10-71	Proceed, transmission in sequence
10-77	Negative contact
10-81	Reserve hotel room for
10-82	Reserve room for
10-85	My address is
10-91	Talk closer to mic
10-93	Check my frequency on this channel
10-94	Give me a long count
10-99	Mission completed, all units secure
10-200	Police needed at

# Frequency Ranges

# 25 LX Specifications

The Cobra 25 LX transceiver represents one of the most advanced AM two-way radios used as a Class D station in the Citizens Radio Service. This unit features advanced Phase Lock Loop (PLL) circuitry providing complete coverage of all 40 CB channels.

CB Channel	Channel Freq. In MHz	CB Channel	Channel Freq. In MHz
1	26.965	21	27.215
2	26.975	22	27.225
3	26.985	23	27.255
4	27.005	24	27.235
5	27.015	25	27.245
6	27.025	26	27.265
7	27.035	27	27.275
8	27.055	28	27.285
9	27.065	29	27.255
10	27.075	30	27.305
11	27.085	31	27.315
12	27.105	32	27.325
13	27.115	33	27.335
14	27.125	34	27.345
15	27.135	35	27.355
16	27.155	36	27.365
17	27.165	37	27.375
18	27.175	38	27.385
19	27.185	39	27.395
20	27.205	40	27.405

**GENERAL**

CHANNELS	CB - 40 CH
FREQUENCY RANGE	CB - 26.965 TO 27.405 MHZ
FREQUENCY TOLERANCE	0.005 %
FREQUENCY CONTROL	PLL (PHASE LOCK LOOP) SYNTHESIZER
OPERATING TEMPERATURE	
RANGE	-30° C TO + 50° C
MICROPHONE	Plug-in dynamic
INPUT VOLTAGE	13.2VDC nom. (positive or negative ground)
Current Drain	Transmit: AM full mod., 1.5A (maximum) Receive: Squelched, 0.3A; full audio output, 1.2A (nominal)
Size	8-5/8" D x 6-3/8" W x 2-3/16" H
Weight	4 lbs.
Antenna Connector	UHF; SO-239
Meter	Indicates relative power output received signal strength

**TRANSMITTER**

Power Output	4 watts
Modulation	AM (Amplitude Modulation)
Frequency Response	300 to 3000 Hz
Output Impedance	50 ohms, unbalanced

**RECEIVER**

Sensitivity	Less than 1 μV for 10 dB (S+N) /N
Selectivity	6 dB @ 7 KHz, 60 dB @ 10KHz
Image Rejection	80 dB, typical
Adjacent-Channel Rejection	60 dB, typical
IF Frequencies	Double Conversion: 1st: 10.695 MHz 2nd: 455 KHz
Automatic Gain Control (AGC)	Less than 10 dB change in audio output for inputs from 10 to 50,000 microvolts
RF Gain range	40 db
Noise Blanker	RF type
Squelch	Adjustable; threshold less than 1μV
Audio Output Power	4 watts
Frequency Response	300 to 3000 Hz
Distortion	Less than 7% @3 watts @ 1000 Hz
Built-in Speaker	8 ohms, 5w
External Speaker (Not supplied)	8 ohms; disables internal speaker when connected

**PA SYSTEM**

Power Output	4 watts into external speaker
External Speaker for PA	8 ohms 4 Watts min.
(Not Supplied)	the PA speaker also monitors the receiver; separate jack provided

(SPECIFICATIONS SUBJECT TO CHANGE WITHOUT NOTICE)

# Limited Two Year Warranty

**COBRA ELECTRONICS CORPORATION** warrants that its Cobra CB Radios, and the component parts thereof, will be free of defects in workmanship and materials for period of two (2) years from the date of first consumer purchase. This warranty may be enforced by the first consumer purchaser, provided that the product is utilized within the U.S.A.

Cobra will, without charge, repair or replace, at its option, defective CB radios, products or component parts upon delivery to the Cobra factory Service Department, accompanied by proof of the date of first consumer purchase, such as a duplicated copy of a sales receipt.

You must pay any initial shipping charges required to ship the product for warranty service, but the return charges will be at Cobra's expense, if the product is repaired or replaced under warranty.

**Exclusions:** This limited warranty does not apply; 1) to any product damaged by accident; 2) in the event of misuse or abuse of the product or as a result of unauthorized alterations or repairs; 3) if the serial number has been altered, defaced or removed; 4) if the owner of the product resides outside the U.S.A.

All implied warranties, including warranties of merchantability and fitness for a particular purpose are limited in duration to the length of this warranty. Cobra shall not be liable for any incidental, consequential or other damages; including, without limitation, damages resulting from loss of use or cost of installation.

Some states do not allow limitations on how long an implied warranty lasts and/or do not allow the exclusion or limitation of incidental or consequential damages, so the above limitations may not apply to you.

## Cobra Electronics Corporation

6500 West Cortland Street  
Chicago, Illinois 60707  
[www.cobra.com](http://www.cobra.com)

# Optional Accessories

You can find quality Cobra products and accessories at your local Cobra dealer, or in the U.S.A., you can order directly from Cobra. See ordering info on page 38.

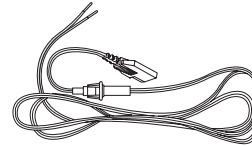

**Replacement DC Power Cord**

For in vehicle use  
426-002-N-001

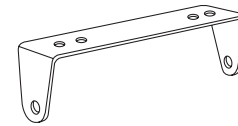

**Replacement Mounting Bracket**

For in vehicle use  
251-199-9-001

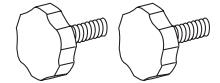

**Replacement Thumb Screws**

For in vehicle use  
634-081-9-001

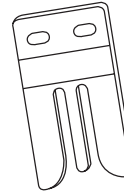

**Replacement Microphone Bracket**

For in vehicle use  
741-080-9-001



**21" Base Loaded Magnet Mount Antenna**

HG A1000



**38" Base Loaded Magnet Mount Antenna**

HG A1500



**Dynamic External Speaker**

HG S100



**Noise Canceling External Speaker**

HG S300



**Noise Canceling With Talk Back External Speaker**

HG S500



## If You Think You Need Service

For technical assistance, please call our Automated Help Desk which can assist you by answering the most frequently asked questions about Cobra products.

**(773) 889-3087**

24 hours a day, 7 days a week.

A Consumer Service Representative can be reached through this same number

8:00 am - 5:30 pm, Monday through Friday, Central Time.

Technical assistance is also available on-line in the Frequently Asked Questions (FAQ) section at [www.cobraelec.com](http://www.cobraelec.com) or by e-mail to [productinfo@cobra.com](mailto:productinfo@cobra.com)

If you think you need service call 1.773.889.3087

*"If your product should require factory service please call Cobra first before sending your unit in. This will ensure the fastest turn-around time on your repair."*

You may be asked to send your unit to the Cobra factory. It will be necessary to furnish the following in order to have the product serviced and returned.

1. For Warranty Repair include some form of proof-of-purchase, such as a mechanical reproduction or carbon or a sales receipt. If you send the original receipt it cannot be returned.
2. Send the entire product.
3. Enclose a description of what is happening with the unit. Include a typed or clearly print name and address of where the unit is to be returned.
4. Pack unit securely to prevent damage in transit. If possible, use the original packing material.
5. Ship prepaid and insured by way of a traceable carrier such as United Parcel Service (UPS) or First Class Mail: to avoid loss in transit to: Cobra Factory Service, Cobra Electronics Corporation, 6500 W. Cortland St., Chicago, IL 60707.
6. If the unit is in warranty, upon receipt of your unit it will either be repaired or exchanged depending on the model. Please allow approximately 3 to 4 weeks before contacting us for status. If the unit is out of warranty a letter will automatically be sent informing you of the repair charge or replacement charge. If you have any questions, please call 1.773.889.3087 for assistance.

## Trademark Info

Cobra®, Dynamike®, Nothing Comes Close to a Cobra® and the snake design are registered trademarks of Cobra Electronics Corporation, USA.

Cobra Electronics Corporation™ is a trademark of Cobra Electronics Corporation, USA.

# Operating Instructions for your Cobra 25 LX Special Edition CB Radio



U.S. Patent Nos. D630202, D630625

©2012 Cobra Electronics Corporation  
Printed in China

Part No. 480-744-P Version B

Nothing Comes Close to a Cobra®

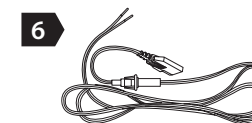
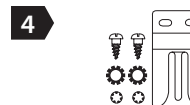
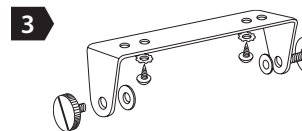
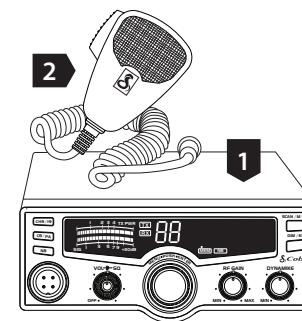

The Citizens Band lies between the shortwave broadcast and 10-meter Amateur radio bands, and was established by law in 1949. The Class D two-way communications service was opened in 1959. (CB also includes a Class A citizens band and Class C remote control frequencies.)

## FCC Regulations

FCC regulations permit only "transmissions" (one party to another) rather than "broadcasts" (to a wide audience). Thus, advertising is not allowed on CB Channels because that is "broadcasting."

## FCC Warnings

All transmitter adjustments other than those supplied by the manufacturer as front panel operating controls, must be made by, or under the supervision of, the holder of an FCC-issued General Radio-Telephone Operator's License.

Replacement or substitution of transistors, regular diodes or other parts of a unique nature, with parts other than those recommended by Cobra, may cause violation of the technical regulations of Part 95 of the FCC Rules, or violation of Type Acceptance requirements of Part 2 of the Rules.

You should read and understand Part 95 (included with this unit) of the FCC Rules and Regulations, before operating your Cobra radio, even though the FCC no longer requires you to obtain an operator's license.

## What's Included with Your 25 LX

- |                        |                          |
|------------------------|--------------------------|
| 1. CB transceiver      | 5. Operating Manual      |
| 2. Microphone          | 6. DC power cord         |
| 3. Transceiver bracket | 7. FCC rules (not shown) |
| 4. Microphone bracket  |                          |

# Controls and Indicators

# Our Thanks to You

# Optional Accessories

**Front Side**

- 1. 4-Pin Microphone Connector
- 2. Power On/Off, Volume
- 3. Squelch
- 4. Dynamike
- 5. Menu/Enter/Channel Selector
- 6. RF Gain
- 7. Dim/Escapе Button
- 8. Channel 9/Channel 19 Button
- 9. Scan/Memory Scan
- 10. CB/PA Button
- 11. LCD Display
- 12. RX (Receive)/TX (Transmit), Indicators
- 13. Signal Strength Meter
- 14. NB Button
- 15. Microphone

**Back Side**

- 16. Public Address Speaker Jack
- 17. External Speaker Jack
- 18. Antenna Connector
- 19. Power Jack

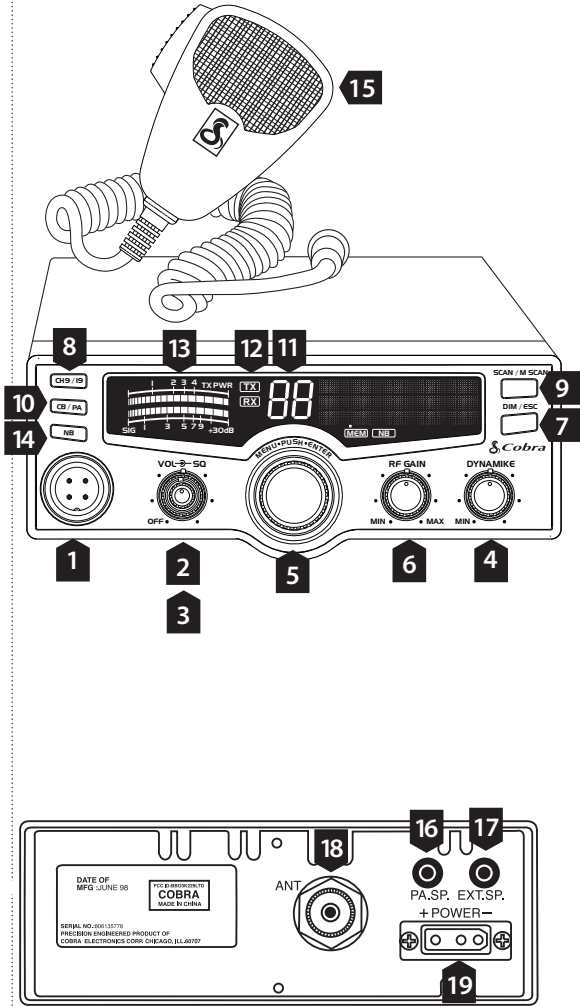

Thank you for purchasing the Cobra 25 LX CB Radio. Properly used, this Cobra product will give you many years of reliable service.

**Customer Support**

Should you encounter any problems with the product or not understand its many features, please refer to this owner's manual. If, after referring to the manual, you still need help, call Cobra Customer Service at 773.889.3087.

**NOTE**  
 This device complies with part 15 of the FCC Rules. Operation is subject to the following two (2) conditions:  
 1. This device may not cause harmful interference, and  
 2. This device must accept any interference received, including interference that may cause undesired operation.

The manufacturer is not responsible for any radio or tv interference caused by unauthorized modifications to this equipment. Such modifications could void the user's authority to operate the equipment.

**Cobra Customer Service**

Live operators are available  
 M-F 8:00 am - 5:30 pm Central  
 Time at: 773-889-3087

Automated Technical  
 Assistance available 24 hours a  
 day, seven days a week. E-mail  
 questions to: [productinfo@cobra.com](mailto:productinfo@cobra.com)

Cobra on the World Wide Web:  
 Frequently Asked Questions  
 (FAQ) can be found on-line at:  
[www.cobra.com](http://www.cobra.com)

**Ordering From U.S.A.**

Call 773-889-3087 for pricing or visit [www.cobra.com](http://www.cobra.com).

**For Credit Card Orders**

Call 773-889-3087 [Press one from the main menu] 8:00 a.m. to 5:30 p.m. Central Time, Monday through Friday.

**Make Check or Money Order Payable To**

Cobra Electronics, Attn: Accessories Dept.,  
 6500 West Cortland Street, Chicago, IL 60707 U.S.A.

**To Order Online**

Please visit our website: [www.cobra.com](http://www.cobra.com)