



Compatible with 6V and a wide range of 12V batteries.

Table of Contents

Important Safety Information	2
Battery Charger 2A Features	4
Quick Start Section	5
Connecting Your Charging Cables	5
Charging Your Battery	6
Display Light Overview	7
Operation Overview	8
Specifications	9
Limited 2-Year Warranty	10
Product Service	11
Ordering Info	12

Important Safety Instructions

Save these instructions. This manual contains important safety and operation instructions for the Cobra Battery Charger 2A: #CPBM2A. Read and understand ALL safety information before using this product. Failure to follow these safety instructions may result in electrical shock, explosion and fire.

- Incompatible, unmonitored and damaged batteries can explode if used with this product. Do not leave product unattended while it is in use. Do not attempt to charge a frozen or damaged battery. Only use this product with batteries of recommended voltage. Always operate this product in a well-ventilated area. Batteries generate explosive gases during normal battery operation. To lower the risk of a battery explosion, follow all safety information contained within as well as those published by the battery manufacturer.
- This product is an electrical device that emits heat and can cause burns if not operated properly. Do not smoke or use any source of electrical spark or fire when operating this product. Keep product away from combustible materials and never cover the product during operation.
- This product produces electrical currents that can shock and cause serious injury, including death. Do not cut any of connecting cables, submerge in water, or get wet.
- Working with batteries can cause exposure to battery acid that can cause eye and skin irritation. Always wear eye protection when operating this product or working with batteries. In case of contamination of eyes or skin, flush affected area with running water and contact your local poison control immediately.

Precautions when working with the Battery Charger 2A:

 **Before using the charger**, carefully read all instructions and warnings within this manual as well as the battery manufacturer's specific precautions and recommended rates of charge for the battery. Make sure to determine the voltage and chemistry of the battery by referring to your battery owner's manual prior to charging.

 **Do not** expose charger to rain or snow.

 The use of an attachment not recommended or sold by the battery charger manufacturer may result in a risk of fire, electric shock, or injury to persons.

 An extension cord should not be used unless absolutely necessary. Use of improper extension cord could result in a risk of fire and electric shock. If an extension cord must be used, make sure:

- That pins on plug of extension cord are the same number, size, and shape as those of plug on charger;
- That extension cord is properly wired and in good electrical condition; and
- That wire size is large enough for the AC current rating of the battery charger

Do not operate the charger with a damaged cord or plug.

Do not operate the charger if it has received a sharp blow, been dropped, or otherwise damaged in any way.

To reduce the risk of electric shock, unplug charger from outlet before attempting any maintenance or cleaning.

The main unit connector cable cannot be replaced. If the cord is damaged the charger should be scrapped.

Precautions when working with vehicle batteries:

WARNING: Explosion and fire hazard

- 1.** Follow all instructions published by the battery manufacturer and the manufacturer of the equipment in which the battery is installed.
- 2.** Make sure the area around the battery is well-ventilated.
- 3.** Never smoke or allow a spark or flame in the vicinity of the engine or batteries.
- 4.** Be careful not to drop a metal object on the battery or allow a metal tool to simultaneously touch the positive and negative cable ends or battery terminals.
- 5.** Remove personal metal items such as rings, bracelets, necklaces, and watches when working with batteries. Batteries produce a short-circuit current high enough to weld a ring or other similar objects to metal, causing a severe burn.
- 6.** If you need to remove a battery, always remove the negative terminal from the battery first. Make sure all accessories are off to prevent causing a spark.
- 7.** Someone should be within range of your voice, or close enough to come to your aid when you work near batteries.
- 8.** Have plenty of fresh water, soap and a supply of baking soda on hand in the area of the batteries in case of contact with battery acid. Baking soda neutralizes lead acid battery electrolyte.

Battery Charger 2A Features

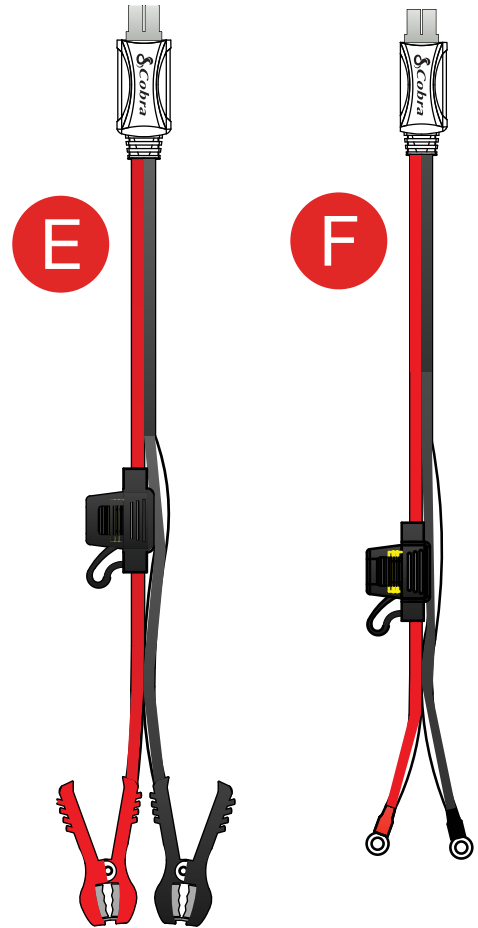
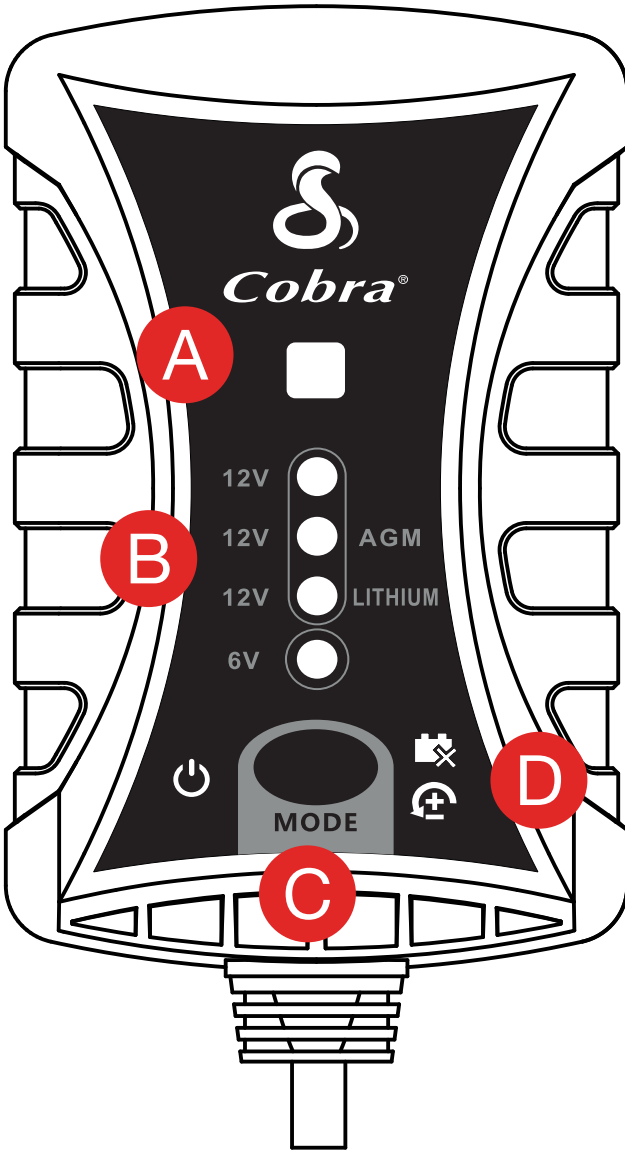

- A.** LED Status Light
- B.** Battery Type & Voltage Selection
- C.** Mode Selection Button

- D.** Warning Indicators
- E.** Alligator Cables
- F.** O-Ring Cables

Connecting Your Charging Cables

Do not connect the battery charger into an AC outlet until all other connections have been made. Do not make any connections to the carburetor, fuel lines, or thin metal sheet parts. The instructions provided are for a negative ground system commonly found in most passenger vehicles. If your vehicle is a positive ground system, simply follow the instructions in reverse order.

1. Connect the positive (**red**) alligator clamp or O-ring terminal to the positive battery terminal
2. Connect the negative (**black**) alligator clamp or O-ring terminal to the negative battery terminal or vehicle chassis.
3. Connect the opposite end of your cable to the battery charger main cable.
4. Connect the battery charger into a suitable electrical outlet.

- 1 Determine which connection type is needed (Alligator or O-ring)

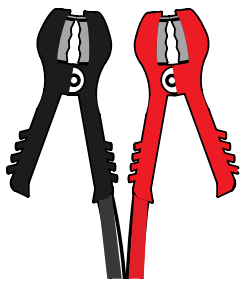

Alligator Clamps

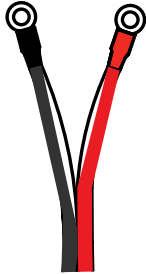

O-Ring Terminals

- 2 Connect either the alligator clamps or O-ring terminals to your battery. (First, **red** to positive, then **black** to negative).

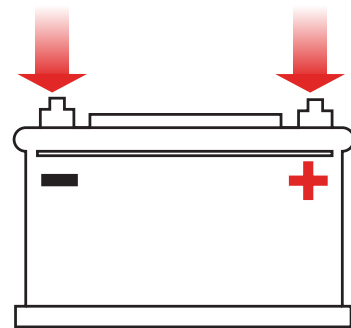

- 3 Connect the opposite end of your cable to the battery charger main cable



- 4 Plug the battery charger into a suitable electrical outlet

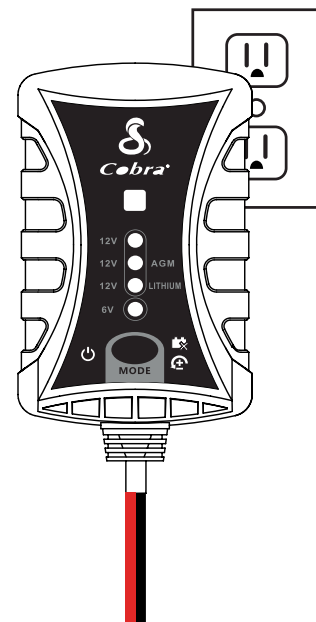

Charging Your Battery

Always make sure to check your battery before charging to verify its type and the correct charging mode required.

1. When the charger is first plugged into a suitable electrical outlet it will enter standby mode and the standby power indicator will illuminate orange.
2. Press the mode button to cycle through to the desired charging mode. For 6V and Low Voltage charging modes, press and hold the mode button for two (2) or six (6) seconds depending on which mode you wish to enter.
3. Once the desired charge mode has been selected the LED status light will illuminate (depending on the health of the battery) and begin blinking orange to indicate that charging has started. For a more detailed list on the LED status light readout, refer to the table on the following page.
4. Charging is completed when the LED status light shows a solid green readout. At this point you can either remove the battery charger or leave it connected in order to provide maintenance charging.

- 1 Verify your battery's voltage and type

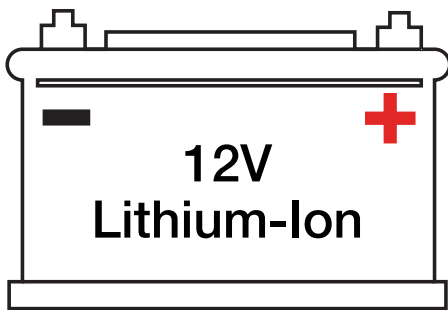

- 2 Select the desired battery voltage and type on the battery charger by pressing the mode button to cycle through

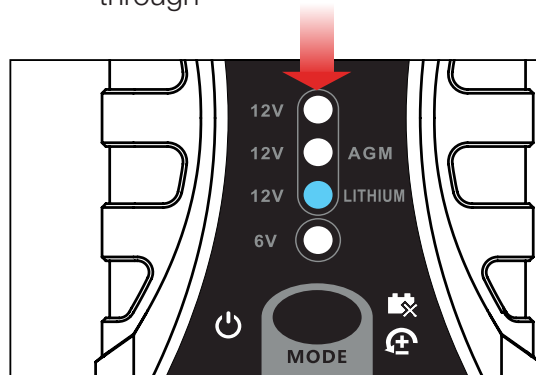

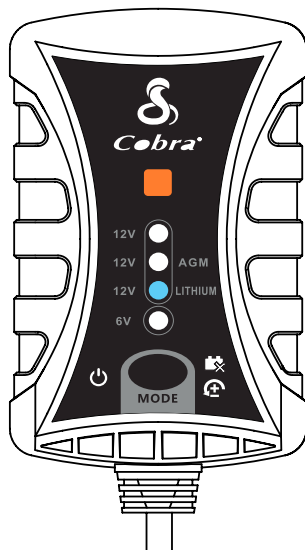

- 3 Charging has begun when the LED status light begins to blink orange

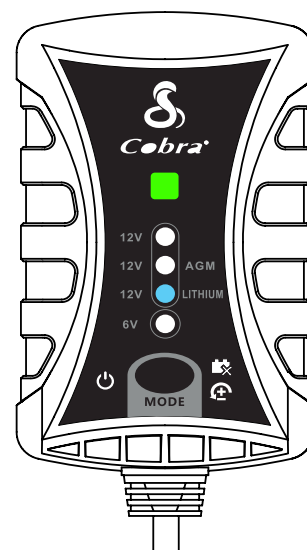

- 4 When charging is complete (solid green light) you can safely leave the charger connected to maintain a full charge or disconnect and store for future use



Display Light Overview

 Standby Power	Unit is on and in standby mode, Indicator waiting to begin charging.
 Bad Battery	There is a possible battery short or the battery will not hold a charge. Have the battery checked by a professional.
 Reverse Polarity	Battery Charger cables are connected to the battery in reverse. Reverse the cable connections.

LED	Condition
No LED	Charger plugged in but not connected to a battery. Please connect either the alligator or o-ring cables to the desired battery and select the corresponding battery type on the Battery Charger to begin charging.
Blinking Orange	The battery is charging.
Solid Green	Charging complete.
Blinking Red and Green	Low voltage mode. The battery charger uses low voltage mode to charge batteries whose voltage is too low for normal operation.

Operation Overview

Charging Modes

The Cobra Battery Charger 2A has multiple charging modes designed to handle a wide range of battery types and voltages. Always check with the battery manufacturer to verify your battery's specifications and confirm the right charge mode required for your specific battery. Do not operate the charger until you have confirmed the correct charge mode required for your battery.

When charging has finished and the battery charger is removed from the battery, the next time it is connected to a battery it will return to the charging mode that was last used.

Mode	Overview
Standby	When in standby mode, the unit is on but not actively charging your battery. You will see the standby power indicator illuminated orange until you connect your battery charger, select a charging mode and begin to charge your battery. At that point, the power indicator will turn off and the main LED status light will begin to blink orange indicating that charging has started.
12V	This mode is for charging standard 12V lead acid batteries (Wet Cell, Gel Cell, Enhanced Flooded and Maintenance Free batteries)
12V AGM	This mode is for charging 12-Volt AGM batteries
12V Lithium	This mode is for charging 12-Volt Lithium-ion batteries, including lithium iron phosphate.
6V	This mode is for charging standard 6V lead acid batteries (Wet Cell, Gel Cell, Enhanced Flooded and Maintenance Free batteries). Press and hold for two (2) seconds in order to enter 6V charging mode.
Low Voltage Mode	Low Voltage mode is intended for charging batteries whose voltage has dropped too low to be detected normally. If the battery charger has been unable to detect your battery voltage due to it being too low, press and hold for six (6) seconds in order to enter Low Voltage Mode. At this point all modes will flash. Select your desired charging mode and the LED status light will begin to flash between green and red indicating that Low Voltage Mode charging has begun. Low Voltage Mode will charge for five (5) minutes, after which the battery charger will return to normal charging operation.*

***Caution:** Using Low Voltage Mode bypasses certain safety functions of the battery charger. Check that all connections have been made prior to entering Low Voltage Mode and do not touch the end connectors together once Low Voltage Mode has been activated. Risk of sparks, fire, explosion, property damage, injury and death can occur if not operated properly.

Specifications

Dimensions	4.3" X 2.5" X 1.7" (HxWxD)
Weight:	.54lbs
Input Voltage AC	100-200VAC, 50-60Hz 0.6A
Output	6/12VDC 2A
Charging Current	2A (6V), 2A (12V)
Storage Temperature	-20° C to +45° C
Operating Temperature	-10° C to +40° C
Supported Batteries	6V, 12V
Compatible Battery Chemistries	Wet Cell, Gel Cell, Enhanced Flooded, Maintenance Free, AGM, Lithium

Frequently Asked Questions

1. Is it safe to leave my battery charger connected when charging is complete?

Yes, you can leave your battery charger connected to a battery once charging is finished. The charger will enter maintenance mode and keep the battery fully charged.

2. How often should I use my battery charger?

The battery charger can be used as often as you see fit. If the battery is low the charger will enter a normal charging cycle and if the battery is instead in a healthy condition the charger will automatically enter a maintenance mode to keep the battery fully charged.

3. How long will it take for my battery to reach full charge?

This will depend on your battery's current state and battery type when charging begins. Generally 12V battery would take up to 15 to 30 hours to reach full charge.

4. How do I know what type of battery is in my vehicle?

Consult your battery manufacturer's product specifications page for the specific details on the particular battery model# installed in your vehicle.

5. How do I locate my battery?

Most car batteries will be easily found under the hood of your car near the engine. However, consult your vehicle owner's manual for the specific location.

6. Can you use this charger outdoors?

You can use this charger outdoors to charge batteries as needed. Do note though that this product is not waterproof and special care must be taken to keep this product from getting wet.

7. Do I need to disconnect my battery from my car in order to charge it?

You do not need to disconnect your battery from your vehicle in order to charge it with the battery charger.

Limited 2-Year Warranty

Warranty Terms:

Cobra warrants your product against all defects in materials and workmanship for a period of two (2) years from the date of original purchase.

Cobra, at our sole discretion, will repair or replace your product (with the same or comparable product) free of charge.

Cobra will not pay shipping charges that you incur for sending your product to us. Products received COD will be refused.

To make a warranty claim, we will require proof of purchase in the form of an invoice or receipt. No proof of purchase is required for factory direct purchases.

Warranty Exclusions: Warranty does not apply to your product under any of the following conditions: 1. The serial number has been removed or modified. 2. Your product has been subjected to misuse or damage (including water damage, physical abuse, and/or improper installation). 3. Your product has been modified in any way. 4. Your receipt or proof-of-purchase is from a non-authorized dealer or internet auction site including E-bay, U-bid, or other non-authorized resellers.

LIMITATION OF WARRANTY: EXCEPT AS EXPRESSLY PROVIDED HEREIN, YOU ARE ACQUIRING THE PRODUCT “AS IS” AND “WHERE IS”, WITHOUT REPRESENTATION OR WARRANTY. COBRA SPECIFICALLY DISCLAIMS ANY REPRESENTATION OR WARRANTY INCLUDING, BUT NOT LIMITED TO THOSE CONCERNING THE MERCHANTABILITY AND SUITABILITY OF THE PRODUCT FOR A PARTICULAR PURPOSE. COBRA SHALL NOT BE LIABLE FOR CONSEQUENTIAL, SPECIAL OR INCIDENTAL DAMAGES INCLUDING, WITHOUT LIMITATION, DAMAGES ARISING OUT OF THE USE, MISUSE OR MOUNTING OF THE PRODUCT.

The above limitations or exclusions shall be limited to the extent they violate the laws of any particular state. Cobra is not responsible for products lost in shipment between the owner and our service center.

General Warranty Information

Each product we manufacture is covered by our factory warranty. While each product may have unique components and policy, the general guideline below will apply to most Cobra products.

All Cobra products purchased factory-direct or from our Authorized Resellers will come with a full one to three (1-3) year warranty from the date of the original retail purchase (see policy statement above for full warranty details and exclusions).

Standard accessories packaged with each model will have a one-year factory warranty.

Accessory items have a one-year factory warranty.

Shipping to our facility is not covered in our warranty. Return shipping is included within the US.

This warranty is non-transferrable.

For the sake of clarity, ‘repair or replace the Product or its defective part’ does not include removal or installation work, costs or expenses which include but are not limited to labor costs or expenses.

Cobra will not be responsible for lost packages.

Product Service

If you have any questions about operation or installing your new Cobra product, PLEASE CONTACT COBRA FIRST...do not return this product to any retail store.

The contact information for Cobra will vary depending on the country in which you purchased and utilize the product. For the latest contact information, please go to www.cobra.com/support

For products purchased in the U.S.A. you may call 800-543-1608.

For products purchased in the U.S.A., if your product should require factory service, please go to www.cobra.com/support and follow the instructions for returning your product to the Cobra Factory Service Department for service.

Should there be any problems with this product or further information is needed on its features please visit www.cobra.com for support, frequently asked questions, Declarations of Conformity, and full manuals.

For Products Purchased Outside the U.S.A. or Canada

Please contact your local dealer for product service information.

This device complies with part 15 of the FCC Rules. Operation is subject to the following two conditions: 1) This device may not cause harmful interference, and 2) this device must accept any interference received, including interference that may cause undesired operation.

For Products Used in Canada

Industry Canada Notice

This device complies with Industry Canada license-exempt RSS standard(s). Operation is subject to the following two conditions:

- 1 this device may not cause interference, and
- 2 this device must accept any interference, including interference that may cause undesired operation of the device.

Le présent appareil est conforme aux CNR d'Industrie Canada applicables aux appareils radio exempts de licence. L'exploitation est autorisée aux deux conditions suivantes:

- 1 l'appareil ne doit pas produire de brouillage, et
- 2 l'utilisateur de l'appareil doit accepter tout brouillage radioélectrique subi, même si le brouillage est susceptible d'en compromettre le fonctionnement.

Ordering Info

You can find quality Cobra products and accessories at your local Cobra dealer, or in the U.S.A., you can order directly from Cobra.

Please visit www.cobra.com

Web orders will normally ship the next business day if received by us before 2:00 PM Eastern Time. Orders do not ship on weekends or holidays. All standard deliveries are Monday-Friday only. Saturday delivery can be requested in certain areas of the country for an additional shipping fee by calling Sales at **800-543-1608**.

Certain orders may require additional days to process prior to shipping. Holidays may also impact processing and shipping time frame. Occasionally, items may not ship due to inventory depletion. If you need your item to be expedited, **we recommend calling Sales at 800-543-1608**.

Order Acceptance

Once your order has been accepted and processed, you will receive an email that will include the shipping carrier and tracking information.

Shipping and Delivery

Free ground shipping is included to 48 states. Hawaii, Alaska and Puerto Rico ship based on assessed fee at checkout.

We require a physical address for shipping. Sorry, no P.O. Boxes or APO/FPO addresses. Please select 2-day or next day air for shipments to Hawaii or Alaska. Shipping charges are calculated on a per-product basis. Please make note of the shipping charges associated with each item.

** For safety reasons, we cannot ship power packs/Jumpacks via air delivery methods. These items are available to ship via ground service only.

** For your protection, some orders may require a signature for delivery.

Cobra® and the snake design are registered trademarks of Cobra Electronics Corporation, USA.

Cobra Electronics Corporation™ is a trademark of Cobra Electronics Corporation, USA.

Other trademarks and trade names are those of their respective owners.