

The Cobra line of quality products includes:

- CB Radios
- microTALK® Radios
- Radar/Laser Detectors
- Safety Alert® Traffic Warning Systems
- HighGear® Accessories
- CobraMarine® VHF Radios
- Power Inverters
- Accessories

For more information or to order any of our products, please visit our website: www.cobra.com

Nothing Comes Close to Cobra®

Jump Starter/PowerPack with Air Compressor Operating Instructions



©2009 Cobra Electronics Corporation
Version C
Printed in China
Part No. 480-549-P



Thank you for purchasing the Cobra CJIC 250 jump starter/power pack with built-in air compressor. Properly used, this Cobra product will give you many years of reliable service.

Easy-to-use and designed for reliable service, the 100W Mobile power pack can run many AC appliances and 12V DC appliance whenever you need power for work or play, at home or on the road.

Important: Please be sure to read and save the entire manual before using your mobile power pack. Any misoperation or misusing may damage the equipment or create hazardous conditions for the user. Please keep this manual for future reference.

What's Included with Your CJIC 250

1. Power pack with jump start cables with built-in air compressor
2. 120V AC charging adapter
3. Owner's operating instructions
4. Inflation nozzles

Introduction

Buttons, Switches & Indicators

1. USB power port
2. USB power indicator
3. USB/LED power switch
4. Charging indicator
5. Charging jack
6. Battery level indicators
7. Battery level button
8. Battery connection indicator
9. Reverse polarity indicator
10. 120V AC power switch
11. 120V AC socket / cover
12. LED work lights
13. 12V DC socket / cover
14. Jump start power switch
15. Positive battery clamp (red)
16. Negative battery clamp (black)
17. Carry handle
18. Fuse
19. Air compressor
20. Air compressor on/off switch
21. Air compressor hose compartment

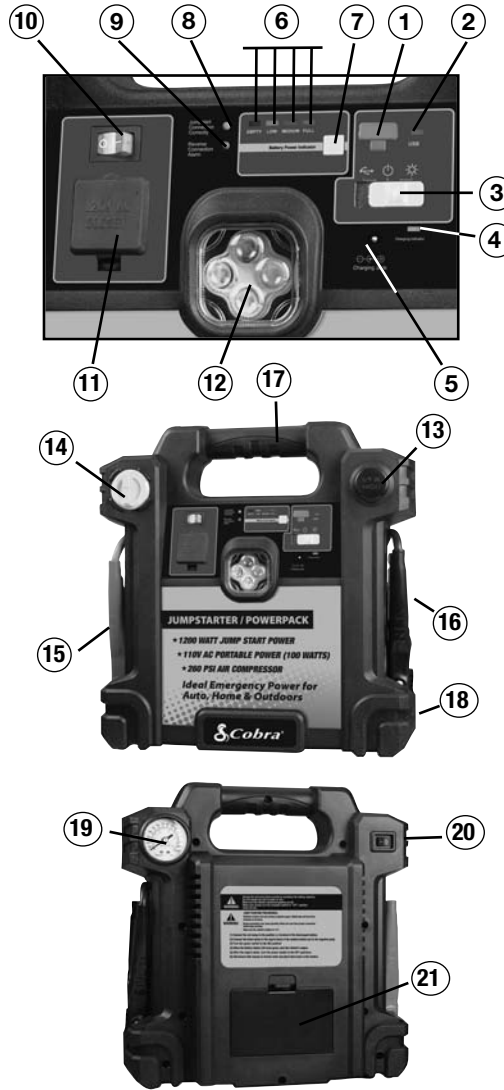

Note: See page 6 - 7 for more information on features.

Introduction

Customer Assistance

Should you encounter any problems with this product, or not understand its many features, please refer to this owner's manual. If you require further assistance after reading this manual, Cobra Electronics offers the following customer assistance services:

For Assistance in the U.S.A.

Automated Help Desk English only.
24 hours a day, 7 days a week 773-889-3087 (phone).

Customer Assistance Operators English and Spanish.

8:00 a.m. to 5:30 p.m. Central Time, Monday through Friday
(except holidays) 773-889-3087 (phone).

Questions English and Spanish.

Faxes can be received at 773-622-2269 (fax).

Technical Assistance English only.

www.cobra.com (on-line: Frequently Asked Questions).
English and Spanish. productinfo@cobra.com (e-mail).

For Assistance Outside the U.S.A.

Contact Your Local Dealer

©2009 Cobra Electronics Corporation
6500 West Cortland Street
Chicago, Illinois 60707 USA
www.cobra.com

Warranty and Trademark Acknowledgement

For Products Purchased in the U.S.A.

Cobra Electronics Corporation warrants that its Cobra jump starter/power pack, and the component parts thereof, will be free of defects in workmanship and materials for a period of one year from the date of first consumer purchase. This warranty may be enforced by the first consumer purchaser, provided that the product is utilized within the U.S.A.

Cobra will, without charge, repair or replace, at its option, defective jump starter/power pack products or component parts upon delivery to the Cobra Factory Service department, accompanied by proof of the date of first consumer purchase, such as a duplicated copy of a sales receipt.

You must pay any initial shipping charges required to ship the product for warranty service, but the return charges will be at Cobra's expense, if the product is repaired or replaced under warranty. This warranty gives you specific legal rights, and you may also have other rights which may vary from state to state.

Exclusions: This limited warranty does not apply:

1. To any product damaged by accident.
2. In the event of misuse or abuse of the product or as a result of unauthorized alterations or repairs.
3. If the serial number has been altered, defaced, or removed.
4. If the owner of the product resides outside the U.S.A.

All implied warranties, including warranties of merchantability and fitness for a particular purpose are limited in duration to the length of this warranty. Cobra shall not be liable for any incidental, consequential or other damages; including, without limitation, to damages resulting from loss of use or cost of installation.

Some states do not allow limitations on how long an implied warranty lasts and/or do not allow the exclusion or limitation of incidental or consequential damages, so the above limitations may not apply to you.

For Products Purchased Outside the U.S.A.

Please contact your local dealer for warranty information.

Trademark Acknowledgement

Cobra®, Nothing Comes Close to a Cobra® and the snake design are registered trademarks of Cobra Electronics Corporation, USA.

Cobra Electronics Corporation™ is a trademark of Cobra Electronics Corporation, USA.

How to Use Your Cobra CJIC 250

Introduction	A1
Our thanks to you	
What's included	
Buttons, Switches & Indicators.....	A2
Customer Assistance.....	A3
Conventions	2
Safety Information	3
Controls and Indicators.....	6
Operation	8
AC appliances.....	8
Operating AC appliances	9
Some devices you can power up.....	9
Low battery shut down.....	9
Overloads & high temperature protection	9
High surge appliances.....	9
Problem appliances	10
12V DC appliances	10
Operating DC appliances.....	10
USB devices.....	11
Using the Air Compressor.....	11
Inflating tires	12
Inflating small sports equipment	13
Jump starting a vehicle's engine.....	14
Recharging the power pack battery.....	15
Troubleshooting	16
Specifications	18
Product service	19
Warranty Information	20

Features of This Product



- 100W AC output for operating household appliances
- 260 PSI air compressor
- 12 Volt DC power outlet for DC accessories & appliances
- LED super bright emergency light
- 5V USB port to power up or charge cellphones, PDAs or consumer electronic devices
- 1200 Watt (300A) instant starting power to start vehicles
- Rechargeable internal battery
- LED display indicates the battery capacity
- Reverse polarity connection indication & alarm
- On/off safety switch
- Heavy duty cables and clamps



Introduction

Important: Please be sure to read and save the entire manual before using your mobile power pack. Any misoperation or misusing may damage the equipment or create hazardous conditions for the user. Please keep this manual for future reference.

The following conventions are used in this manual:

 WARNING	Warnings identify conditions that could result in personal injury or loss of life.
 CAUTION	Cautions identify conditions or practices that could result in damage to the unit or to other equipment.





NOTE: These notes describe an important action item or an item that you must pay attention to.

Abbreviations and Acronyms:

A	Ampere
AC	Alternating Current
Ah	Amp-hours
DC	Direct Current
LED	light-emitting diode
mA	milli-Ampere
V	Volt
W	Watt

Introduction

Important Safety Instructions

-  **WARNING: Charge unit fully prior to use.**
Keep unit clear of fire and water. The 100W mobile power pack is not intended for use in connection with life support systems or other medical equipment or devices.
-  **WARNING: Shock hazard.**
Keep away from children. The power pack generates the same potentially lethal AC power as a normal household wall outlet. Do not insert foreign objects into the AC outlet, the DC power pack socket, the jump start cable port, or the ventilation hole, do not expose this product to water, rain, snow, condensation, or spray. Do not open the power pack expect to replace the internal battery. Have a qualified technician perform any service work.
-  **WARNING: Explosion hazard**
Do not use this product where there are flammable fumes or gases, such as in the bilge of a gasoline-powered boat, or near propane tanks. Do not use this product in an enclosure containing automotive-type lead-acid batteries. These batteries, unlike the sealed AGM battery in power pack, vent explosive hydrogen gas which can be ignited by sparks from electrical connections. When working on electrical equipment, always ensure someone is nearby to help you in an emergency.
-  **WARNING: Heated surface**
Ensure at least 2" (5cm) air space is maintained on all sides of the power pack. During operation, keep away from materials that may be affected by high temperatures such as blankets, pillows and sleeping bags.
-  **WARNING: Fire hazard**
Never allow jump start cables' red and black clamps to touch each other or another common metal conductor. This could cause damage to the unit and/or create a sparking/explosion hazard. Always disconnect the jump start cables from the unit after use and clip the plastic guard over the jump start cable port.

Jump start cable clamps must be connected positive to positive (red clip to battery "+") and negative to negative (black clip to battery "-" or engine ground). A reverse polarity connection (positive to negative) may cause damage to the unit and/or create a sparking/explosion hazard.

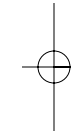

Introduction

WARNING: Fire hazard

The jump start feature is designed for short term operation only- less than 5 seconds. Operating the jump start feature for more than 5 seconds may cause damage to the unit. Allow the power pack to cool down for at least 3 minutes after each jump start.

WARNING: Risk of explosion, fire or burns

The battery terminals exposed at the jump start cable port have enough energy present to cause a spark, creating an explosion hazard, or to cause burns if a metal object contacts both terminals. Always clip the plastic guard over the port when not in use.

CAUTION: Equipment damage

Do not expose the power pack to temperatures over 104° F(40° C) or under 14° F(-10° C).

Precautions when working with batteries

WARNING: Explosion and fire hazard

1. Follow all instructions published by the battery manufacturer and the manufacturer of the equipment in which the battery is installed.
2. Make sure the area around the battery is well-ventilated.
3. Never smoke or allow a spark or flame in vicinity of the engine or batteries.
4. Be careful not to drop a metal object on the battery or allow a metal tool to simultaneously touch the positive and negative cable ends or battery terminals. It might spark or short-circuit the battery or other electrical parts and cause an explosion.
5. Remove personal metal items such as rings, bracelets, necklaces, and watches when working with batteries. Batteries produce a short-circuit current high enough to weld a ring or other similar objects to metal, causing a severe burn.
6. If you need to remove a battery, always remove the negative terminal from the battery first. Make sure all accessories are off so you don't cause an arc.

Introduction

7. Someone should be within range of your voice, or close enough to come to your aid when you work near batteries.
8. Have plenty of fresh water, soap and a supply of baking soda on hand in the area of the batteries in case of contact with battery acid. Baking soda neutralizes lead acid battery electrolyte.
9. The product is supplied with a rechargeable, sealed lead acid battery. This battery is self contained and not consumer replaceable. Batteries must be disposed of properly when they no longer hold a charge. Proper charging practices will increase the life of the batteries.
For information on battery recycling call toll free 800-822-8837.

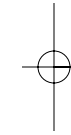

Introduction

Controls and Indicators:

1. USB power port Provides 5 volts output for consumer electronics devices.
2. USB power indicator Illuminates when USB port is in use.
3. USB/LED power switch If the switch is flipped left, the USB port can provide power. Flipped right, the white LED lamps illuminate. Center position, the USB port and LED lamps are off.
4. Charging indicator 2-color LED indicator. When the battery is being charged, this LED indicator lights red, when the battery is fully charged, the LED indicator lights green.
5. Charging jack Charge the battery in the unit by inserting the connector from the AC charging adapter into this jack.

6. Battery level indicators:

Battery Value	Display Mode
U<12.2V	Only red LED indicator lights.
12.2V<U<12.4V	Red and yellow LED light.
12.4V<U<12.6V	Red, yellow and one green LED light.
U>12.6V	Red, yellow and two green LED all light.

Note: It is recommended that you should check the battery voltage every 30 minutes during charging.

7. Battery level button When pressed, indicates the battery charge levels.
8. Battery connection indicator Green LED indicates connection to a battery is correct.

Introduction

9. Reverse polarity indicator Red LED indicates jump start connection to battery is incorrect.
10. 120V AC power switch When this switch is on, the 120V AC is available at the 120V AC socket.
11. 120V AC socket Power outlet for AC accessories.
12. LED lights Four white LED lights for emergency use.
13. 12V DC socket Easy-access output port to charge 12V accessories.

Note: The unit contains 15A fuse for over current protection.

Note: It is recommended that you use the unit to power 12V accessories less than 8A.

14. Jump start power switch Turn this switch after connecting to vehicle to jump start battery.
15. Red battery clamp Positive connector for jump starts.
16. Black battery clamp Negative connector for jump starts.

Note: Be sure that the jump start switch is in **off** position prior to connecting clamps to vehicle's battery. Attach clamps properly to battery (red to positive post, and black to negative chassis ground) before turning jump start switch to **on**.

17. Portable handle For convenient handling of unit.
18. AC charging adapter: Input voltage: 120V AC
Output voltage: 13.5V DC
Input current: 0.3A
19. 260 PSI air compressor Use to inflate tires and small sports equipment.

Note: It is recommended that you charge the interior battery using the AC charging adapter, which offers charge protection.

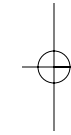

Operation

ⓘ CAUTION: Read all operating instructions before operating the power pack. The power pack is not intended for use as a UPS (Uninterruptible Power Supply). The unit should be operated only in locations that meet the following requirements:

- | | |
|----------------------------|---|
| Dry | Don't allow water or other liquids to drop or splash on the unit. |
| Cool | Ambient air temperature should be between -10° and 40° C (14° and 104° F) – the cooler the better within this range. |
| Ventilated | Leave at least 2" (5 cm) clearance around the unit for air flow. Ensure that the ventilation openings are not obstructed. |
| Safe | Do not operate the unit in the same compartment as batteries or in any compartment capable of storing flammable liquids like gasoline. |
| Protect from battery gases | Do not operate the unit where it will be exposed to battery gases. These gases are very corrosive and prolonged exposure will damage the power pack |

AC appliances

The power pack has one grounded AC power outlet for use with AC appliance. You can either plug the appliance directly into the AC outlet or you can use an AC power bar to increase the number of outlets available.

However, for continuous operations, the combined loads must be less than 80W. The less wattage used, the longer the power pack will operate before recharging is required.

Operating range:

- 80 watts or less for continuous operation
- 100 watts for 5-minute operation

Some appliance may be difficult or impossible to operate from the power pack. They may have high surge requirements or may be incompatible with the output waveform of the power pack. See "High Surge Appliances" and "Trouble Appliances" (page 10).

NOTE: To determine required wattage for a device, look up required Amps a device is rated. This Amperage is found on device I.D. tag in back of the unit. Multiply Amps X Volts = Watts.

Operation

Some devices you can power up:

- 13" TV (80W)
- Video Game System (20W)
- Weather Radio (10W)

Operating AC appliances

1. Check battery status to ensure the battery is fully charged.
2. Open the AC Outlet cover.
3. Turn the AC socket switch ON.
4. Plug the AC appliance into AC outlets.
5. Turn the AC appliance ON.
6. Recharge the power pack immediately after use. See "recharging the power pack battery" (page 12).

Low battery shut down

Unit will automatically shutdown when the battery reaches 10.0V DC. You must turn off the AC power switch and charge the battery.

Overload and high temperature protection

In the event of an overload (>100W) or overheating, the power pack automatically shuts down power to the AC outlets. If, after a while the audible warning is ignored and a manual reset is not performed, the unit will do a complete shutdown automatically.

High surge appliances

The wattage rating of AC appliance is the average power used by the appliance. Appliances such as televisions, computer monitors and appliances with motors consume much more power than their average rating when they are first switched on.

Although power pack can supply momentary surge power up to 400W, some appliances may exceed the capabilities of the power pack and trigger the inverter's safety overload shutdown circuit.

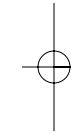

Operation

Problem appliances

The output of the power pack inverter is non-sinusoidal. Some equipment may be damaged by the inverter's modified sine wave output (non-sinusoidal). Some appliance, including the types listed below, may be damaged if they are connected to the inverter.

- Electronics that modulate RF (radio frequency) signals on the AC line will not work and may be damaged.
- Speed controllers found in some fans, power tools, kitchen appliance, and other loads may be damaged.
- Some chargers for small rechargeable batteries can be damaged.
- Metal halide arc (MHI) lights can be damaged.

Note: If you are unsure about powering any device with the power pack, contact the manufacturer of the device to determine whether it is compatible with the modified sine wave output.

12V DC appliances

The power pack can operate one 12V DC auto, RV, marine, or other portable DC appliance that draws 10 amps or less from its DC socket. The combined load must not exceed 120 W. The less combined wattage used, the longer the power pack will operate before recharging is required.

Operating DC appliances:

1. Check battery status to ensure the battery is fully charged.
2. Open the DC socket.
3. Plug the DC appliance into the DC socket.
4. Turn the DC appliance ON.
5. Recharge the power pack immediately after use.

Operation

USB Devices

The power pack can charge or power one USB-chargeable device through its USB port. Compatible devices include most MP3 players, PDAs, digital cameras, and camcorders that have internal batteries which can be charged via the USB port of a desktop/laptop computer.

USB-chargeable devices usually include a special USB cable (not supplied) that attaches one end to the USB port and the other end to the device.

Using the Air Compressor

Warning: Fire Hazard

The compressor is designed for short-term operation only. Operating the compressor over an extended period of time will cause the compressor unit to overheat, which could lead to fire. Allow the compressor to cool down for 10 minutes after each 10 minutes of continuous operations.

Warning: Fire Hazard

Do not leave the compressor unattended while in operation. Keep out of reach of children.

Warning: Risk of personal injury or damage of equipment

Do not exceed the recommended pressure of either the compressor or the object being inflated. The compressor is capable of inflating to 260 PSI. If the recommended pressure is exceeded, an explosion may result.

Warning: Risk of personal injury or damage of equipment

If the power pack with air compressor shuts off due to an over-temperature condition, turn OFF the compressor switch and allow the compressor to cool for 15 minutes before re-starting. If the power switch is not turned off, the compressor will automatically turn itself on when it reaches an acceptable operating temperature. If left unattended, it is possible that the unit can over-inflate the object being inflated and create an explosion hazard.

Caution: Equipment damage

The power pack with air compressor cannot be used to inflate large capacity inflatables such as float tubes, large air mattresses, transport truck tires, and inflatable boats. These types of products require extended inflating times, which may damage the compressor.



Operation

Inflating tires



Caution:

If the pressure gauge on the compressor indicates more than twice the recommended pressure for the object you are inflating and you have only started to inflate the object, the valve connector is incorrectly connected to the valve stem. This may damage the power pack with air compressor. Remove and reattach the valve connector to the valve stem.

To inflate your vehicle, motorcycle, or bicycle tires:

1. Locate valve connector.
2. Remove from storage and uncoil hose.
3. Remove valve stem cap from tire to be inflated.
4. Put the thumb latch in the OPEN position.
5. Insert the desired adapter into the valve connector.
6. Place valve connector firmly and completely over valve stem on the tire.
7. Press the thumb latch toward the house until it locks into the closed position.
8. Insert into the valve receptacle on the item to be inflated.
9. Press the compressor switch to turn the compressor ON.
10. Inflate to desired pressure.
11. Press the compressor switch to turn the compressor OFF.
12. Remove the valve connector from the valve receptacle.
13. Put the thumb latch in the OPEN position.
14. Remove the adapter.
15. Double-check the air pressure with a pressure gauge.
16. Replace valve stem cap.
17. Store the valve connector.

Operation

Inflating small sports equipment

You can use the compressor to inflate small sports equipment such as balls (soccer balls and footballs.)



Caution:

The unit cannot be used to inflate large capacity inflatables such as float tubes, large air mattresses, transport truck tires, and inflatable boats. These types of products require extended inflating times, which may damage the compressor.

To inflate small sports equipment:

1. Choose the appropriate nozzle adapter.
2. If an adapter is required, insert the nozzle adapter into the valve connector, turning it clockwise to tighten, and close the thumb latch.
3. Place the valve connector fully on the valve stem or into the valve receptacle on the item to be inflated.
4. Turn the compressor ON and inflate to appropriate pressure.
5. Turn the compressor OFF before removing valve connector from the valve stem.
6. Remove nozzle adapter from the valve connector and store in storage compartment of Accessory Bag.



Caution:

Allow the compressor to cool down for 10 minutes after each 10 minutes of continuous operation. Repeat if necessary.

Note: Leave the thumb latch in the open position for storing to relieve pressure on the internal mechanism.

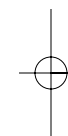

Operation

Jump starting a vehicle's engine

You can use the power pack to jump start a vehicle (or boat engine) that has a 12V starting battery using the jump start cables supplied with the unit.

WARNING: Fire Hazard

A reverse polarity connection may cause damage to the unit and/or create a sparking/explosion hazard. Never allow cables' red and black clamps to touch each other or another common metal conductor. The connection of the cables to the vehicle's battery terminals must be positive to positive (red clamp to battery "+") and negative to negative (black clamp to battery "-" or vehicle chassis).

NOTE: Carefully follow these instructions for jump starting your vehicle as they may be different from the instructions supplied with other jump start products or cables.

To jump start a vehicle:

1. Turn off the vehicle and all accessories.
2. Place the unit on a flat and stable surface near the battery which need to be started. Ensure that the unit's jump start power switch is "OFF".
3. Connect the red positive (+) clamp of the cables to the positive (+) terminal of the engine battery.
4. Connect the black negative (-) clamp of the cables to the engine block, cylinder head, or other stationary heavy metal part of the motor. If the red "Reverse Polarity" LED illuminates, then reverse polarity has been detected. Correct polarity must be established before proceeding. Disconnect the jump starting clamps from the vehicle's battery and repeat steps (3) and (4).
5. Switch on the jump start power switch. Before starting the engine, make sure the jumpstarter pack and the cables are clear of the metal parts and other moving things.
6. Crank the engine for 5 seconds or until it starts, whichever is first.

WARNING: Fire hazard

Do not try to start the engine for more than 5 seconds. The jump start feature is designed for short term operation only. Operating the jump starting feature for more than 5 seconds may cause damage to the unit. Allow the unit to cool down for at least 3 minutes after each start attempt.

Operation

To jump start a vehicle *continued*:

7. Switch off the jump start power switch.
8. Remove the red positive (+) clamp and then the black negative (-) clamp.

Recharging the power pack battery

 **CAUTION:** Do not operate AC or DC appliance while the power pack is being charged.

Charging with the AC charging adapter

Using the AC charging adapter is the simplest method for recharging the battery. While charging from an AC source, the charging status LED indicator will light red. When the battery has reached capacity, the indicator will light orange. Charging when the battery is fully discharged takes around 23 hours.

NOTE: Recharge the 100W mobile power pack as soon as possible after each use. When not used the power pack, it should be recharged every 3 months!

To recharge with AC charger:

1. Turn the rotary switch to the "OFF" position.
2. Plug AC charging adapter into charging jack on the front of the unit.
3. Plug AC charging adapter into 120V AC electrical outlet.
4. Continually charge until the battery is fully charged; for about 23 hours.

 **CAUTION:** The 23-hour charging time for the unit assumes that there is 120V at the AC wall outlet. If the voltage is less than 120V AC, it may take more than 23 hours to fully recharging. Once fully charged, the charging current automatically reduces to a floating charge mode, and the unit may be left permanently connected to the AC charger.



Troubleshooting

Buzzing in audio systems and radios

Some inexpensive stereo systems and AM-FM radios have inadequate internal power supply filtering and “buzz” slightly when powered by the power pack. Generally, the only solution is an audio product with a higher quality filter.

Television interference

The power pack is shielded to minimize its interference with TV signals. However, with weak TV signals interference may be visible in the form of lines scrolling across the screen. The following should minimize or eliminate the problem:

- Increase the distance between the inverter and the TV, antenna and cables.
- Adjust the orientation of the inverter television, antenna and cables.
- Maximize TV signal strength by using a better antenna and use shielded antenna cable where possible.

WARNING: Electric shock hazard

Do not remove the cover of the unit or disassemble. The unit does not contain any internal user-serviceable parts and attempting to service the unit yourself could result in electrical shock or burn.

Troubleshooting

Problem	Cause	Solution
The power pack can not jump start vehicle	The battery in the power pack is not fully charged	Charge it for at 23 hours
	The engine start capacity exceeds the power pack jump start capacity.	
	The power pack's battery has been damaged	Replace the power pack's battery (consult service technician).
The charging status LED indicator does not light.	No AC power at the AC wall outlet.	Ensure power is available at the AC wall outlet.
	AC charging adapter is faulty.	Replace 120V AC charger
The charging status LED indicator still lights red and has not charged to steady after 50 hours of charging.	The AC charger's output is too low.	Replace the AC charger
The AC appliance does not operate; audible alarm is not sounding.	AC appliance rated more than 80W, the safety overload has tripped.	Use AC appliance with a power rating less than 80W.
	AC appliance rated less than 80W, high starting surge has tripped the safety overload.	AC appliance may exceed the power pack's surge capability. Use an AC appliance with a starting surge within the power pack surge rating.
	Battery has discharged to 10V	Recharge the battery.
	Inverter has overheated due to poor ventilation or excessively warm environmental condition.	Allow the power pack to cool for 15 minutes or more. Clear blocked fan opening or remove objects covering the unit, then restart the power pack. Move to a cooler environment.
Run time for appliance is less than expected.	Internal battery is not fully charged,	Recharge using the AC charger, until the charging status LED indicator light green.
	AC appliance power consumption is higher than expected.	Check AC appliance power or wattage rating (or current draw for 12V DC appliance).



Specifications

12 DC Power:

Internal battery (Capacity/Type)	7Ah/12V sealed lead-acid battery
DC power socket (maximum continuous load)	8A with automatic reset
DC fuse	15A

AC Power:

Output power	
• Continuous AC output power	80W
• Five minute AC output power	100W
• AC output surge capacity	400W
Output voltage	104V-125V
Output frequency	58Hz-62Hz
Output wave form	Modified sine wave
No load current draw	<0.5A
Input voltage range	10.5V-15.5VDC
Low battery shutdown	10.0±0.3VDC
Low battery shutdown resume	12.0±0.3VDC
High battery voltage shutdown	15.5V±0.3VDC
Over temperature shutdown	Yes
Overload shutdown	Yes
Operating temperature range	14°F~104°F (-10°C~40°C)
Storage temperature range	-4°F~158°F (-20°C~70°C)

Internal battery charging controller system:

AC charging bulk charging current	300mA
Peak charging voltage (nominal)	14.2V±0.2V
Charging restart voltage (nominal)	12.9V±0.2V

Air compressor:

Inflation pressure	260 PSI
--------------------	---------

Physical Specifications:

Jumpstarter cables (size/length)	8.37mm ² /(460±19.5)mm
Dimensions H*W*D	13.25" H x 12" W x 5.5" D (330.2mm x 309mm x 114.3mm)
Weight	10 lbs., 5.6 oz. (4.7g)

Product Service

For any questions about operating this new Cobra product, or if parts are missing...**PLEASE CALL COBRA FIRST**...do not return this product to the store. See customer assistance on page A3.

If your product should require factory service, please call Cobra first before sending your unit. This will ensure the fastest turn-around time on your repair. You may be asked to send your jumpstarter/power pack to the Cobra factory.

It will be necessary to furnish the following to have the product serviced and returned.

1. For warranty repair include some form of proof-of-purchase, such as a mechanical reproduction or carbon copy of a sales receipt. If you send the original receipt, it cannot be returned.
2. Send the entire product.
3. Enclose a description of what is happening with the jump starter/power pack. Include a typed or clearly printed name and address of where the unit is to be returned.
4. Pack unit securely to prevent damage in transit. If possible, use the original packing material.
5. Ship prepaid and insured by way of a traceable carrier such as United Parcel Service (UPS) or Priority Mail to avoid loss in transit to:

Cobra Factory Service
Cobra Electronics Corporation
6500 West Cortland Street
Chicago, Illinois 60707 USA.

6. If the jumpstarter/power pack is in warranty, upon receipt of your unit, it will either be repaired or exchanged depending on the model. Please allow approximately three to four weeks before contacting Cobra for status. If the unit is out of warranty, a letter will automatically be sent informing you of the repair charge or replacement charge.

If you have any questions, please call 773-889-3087 for assistance.

