

ELECRAFT®

KAT500 AUTOMATIC ANTENNA TUNER



OWNER'S MANUAL

Revision D1, August 15, 2019

E740183

Copyright © 2019, Elecraft, Inc.

All Rights Reserved

Contents

Introduction.....	1
Quick Start.....	1
Customer Service and Support	1
Technical Assistance.....	1
Repair / Alignment Service.....	1
Specifications.....	2
Setup	3
Elecraft K3 Transceiver and KPA500 Amplifier	3
Other Transceiver and Amplifier or Stand-Alone Transceiver	8
Flex 6000-Series Transceivers	10
Icom Transceivers with AH-4 ATU Interface.....	13
Kenwood Transceivers with USB Interface.....	16
Yaesu Transceivers with BCD Band Data	19
Operation	25
Key Line Hot Switching.....	26
Tune Operation and Memories.....	27
Tune Operation	27
Memories	27
Frequency Tracking with an Elecraft K3 Transceiver	28
Band Switching	28
Elecraft K3 and KPA500 Amplifier Combination.....	28
Non-Elecraft Amplifiers	28
The “KAT500 Utility” Program	29
KAT500 Configuration	29
Amplifier Key Interrupt Power	29
Idle Sleep.....	30
Initial Power.....	30
Antennas.....	30
VSWR Thresholds	30
Erase Memories.....	30
Auto Fine Tune	30
Saving Configuration	30
Reset to Factory Default	31
Operating Tips.....	31
Rapid QSY After Antenna Change.....	31
Automatic Bypass on Selected Bands.....	31
Fault Conditions	32
Updating Firmware	32

Kit Assembly Procedure	34
Preventing Electrostatic Discharge Damage	34
Tools Required	34
Assembly Procedure.....	35
Appendix A: Parts List	52
KAT500 Cable Set	52
KAT500 Circuit Board.....	52
Serial Number Envelope E850549	53
KAT500 Core Assembly – E850561	53
Appendix B: KAT500 Frequency Segments	57

 Elecraft manuals with color images may be downloaded from the Elecraft website.

Firmware updates and the Utility Program for the KAT500 are available as a free download from the Support section on the Elecraft website. For those who prefer firmware on media, go to the Elecraft website and search for "Non-Downloadable Firmware" for pricing and availability.

<https://elecraft.com>

Introduction

The KAT500 Automatic Antenna Tuner is designed to be closely integrated with the Elecraft K3 transceiver and the Elecraft KPA500 amplifier although it may be easily used with other transceivers and amplifiers. Features include:

- Automatic band switching, covering the spectrum from 1.8 through 54 MHz.
- Automatic antenna switching to connect one of three antennas according to the band selected.
- L and C settings for lowest SWR are stored in memory for extremely rapid frequency and band changes.
- Robust self-protection circuits that guard against damage from switching high-power RF or trying to match loads outside of its tuning range.
- Static bleed resistor built in to avoid damage from normal static buildup on antennas.
- Low profile enclosure that matches the footprint of the KPA500 and K3, allowing the KAT500 to be placed on top or under either unit (the KAT500 is designed to support the weight of the KPA500).

 **If you purchased your KAT500 as a kit, turn to page 34 for assembly instructions.**

Quick Start

To quickly set up and get started with your KAT500 Automatic Antenna Tuner, turn to page 3 to hook up the unit and page 25 for operating instructions.

Customer Service and Support

Technical Assistance

You can send e-mail to k3support@elecraft.com and we will respond quickly - typically the same day Monday through Friday. Telephone assistance is available from 9 A.M. to 5 P.M. Pacific time (weekdays only) at 831-763-4211. Please use e-mail rather than calling when possible since this gives us a written record of the details of your problem and allows us to handle a larger number of requests each day.

Repair / Alignment Service (We want to make sure everyone succeeds!)

If necessary, you may return your Elecraft product to us for repair or alignment. (Note: We offer unlimited email and phone support to get your kit running, so please try that route first as we can usually help you find the problem quickly.)

IMPORTANT: You must contact Elecraft before mailing your product to obtain authorization for the return, what address to ship it to and current information on repair fees and turnaround times. (Frequently we can determine the cause of your problem and save you the trouble of shipping it back to us.) Our repair location is different from our factory location. We will give you the address to ship your kit to at the time of repair authorization. *Packages shipped to Elecraft without authorization will incur an additional shipping charge for reshipment to our repair depot.*

Elecraft's 1-Year Limited Warranty

This warranty is effective as of the date of first consumer purchase (or if shipped from the factory, the date the product is shipped to the customer). It covers both our kits and fully assembled products. For kits, before requesting warranty service, you should fully complete the assembly, carefully following all instructions in the manual.

Who is covered: This warranty covers the original owner of the Elecraft product as disclosed to Elecraft at the time of order. Elecraft products transferred by the purchaser to a third party, either by sale, gift, or other method, who is not disclosed to Elecraft at the time of original order, are not covered by this warranty. If the Elecraft product is being bought indirectly for a third party, the third party's name and address must be provided at time of order to ensure warranty coverage.

What is covered: During the first year after date of purchase, Elecraft will replace defective or missing parts free of charge (post-paid). We will also correct any malfunction to kits or assembled units caused by defective parts and materials. Purchaser pays inbound shipping to us for warranty repair; we pay shipping to return the repaired equipment to you by UPS ground service or equivalent to the continental USA and Canada. For Alaska, Hawaii, and other destinations outside the U.S. and Canada, actual return shipping cost is paid by the owner.

What is not covered: This warranty does not cover correction of kit assembly errors. It also does not cover misalignment; repair of damage caused by misuse, negligence, battery leakage or corrosion, or builder modifications; or any performance malfunctions involving non-Elecraft accessory equipment. The use of acid-core solder, water-soluble flux solder, or any corrosive or conductive flux or solvent will void this warranty in its entirety. Also not covered is reimbursement for loss of use, inconvenience, customer assembly or alignment time, or cost of unauthorized service.

Limitation of incidental or consequential damages: This warranty does not extend to non-Elecraft equipment or components used in conjunction with our products. Any such repair or replacement is the responsibility of the customer. Elecraft will not be liable for any special, indirect, incidental or consequential damages, including but not limited to any loss of business or profits.

Specifications

Frequency Range	1.8 to 54 MHz, continuous.
Supply Voltage and Current	11 to 15 VDC, 1.0 A max (200 mA typical).
Weight	4.6 lbs (2.1 kg).
Size	Enclosure only, 1.5 x 10.8 x 10.0 in., HWD (3.8 x 27.4 x 25.4 cm). With projections, 1.75 x 10.8 x 11.8 in. (4.4 x 28.4 x 30.0 cm). The projections are the bottom feet and the cable connectors on the rear.
Typical Matching Range and Power Limits	3 — 30 MHz 600 W into 5 Ω to 500 Ω (10:1 SWR). 1000 W into 16 Ω to 150 Ω (3:1 SWR). 1.8 — 2 MHz 600 W into 10 Ω to 500 Ω (5:1 Low Impedance, 10:1 High Impedance SWR). 30 — 60 MHz 500 W into 5:1 SWR (10 Ω to 250 Ω). <i>Matching specified to a 1.0:1 to 1.6:1 output SWR. Power rating is ICAS (Intermittent Commercial and Amateur Service: equal time on and off, 5 min., max. at full power.)</i>
Autotune Power Range	7 W —100 W. <i>For better matching accuracy, tune with >20 W.</i>

Setup

To provide maximum flexibility and the most convenient operation with your existing equipment, there are several ways you can connect the KAT500 to your station.

The following cabling diagrams show how to use the KAT500 with any transceiver and amplifier in the 20 to 1,000 watt output range. Choose the one that fits your station needs:

- Elecraft K3 transceiver and KPA500 amplifier.
- Icom transceiver equipped with the Icom AH-4 ATU interface and any amplifier.
- Other transceiver and any amplifier.

⚠ NOTE: Although the KAT500 works equally well with either a transceiver or a stand-alone transmitter, transceiver is used throughout this manual for simplicity.

Three cables are supplied with your KAT500:

- Computer interface cable, either the KXUSB (USB port) or KXSER (serial port) cable chosen when you ordered your KAT500. The KXSER cable may be in a bag marked E850369.
- Power cable.
- Key Line cable with RCA phono type male connectors.

Elecraft K3 Transceiver and KPA500 Amplifier

Placement

The KAT500 may be placed under or above either the Elecraft K3 transceiver or the KPA500 amplifier. The KAT500 can easily handle the weight of the KPA500 amplifier.

Although the KAT500's feet do not provide the full clearance recommended in the KPA500 Owner's manual, they provide adequate clearance for cooling air to enter the KPA500 for typical operation with low duty-cycle modes (e.g. CW or voice SSB). Operation at higher duty-cycles (e.g. contesting, RTTY, etc.) will cause the amplifier temperature to increase, resulting in higher speed cooling fan operation. For those cases we recommend placing the KAT500 underneath or alongside the KPA500.

Firmware

We strongly recommend that you update your K3 and KPA500 with the latest firmware available from www.elecraft.com. Details about how to do this are in your K3 and KPA500 Owner's manuals. This may not be necessary in every case, but it will help avoid the possibility of some functions not working as expected.

Cabling

The Elecraft K3 and KPA500 amplifier normally use the E850463 Aux interface cable that communicates band selection and other information between the K3 and KPA500. The KAT500 can be included in the E850463 Aux interface path and use the data to switch to the correct band along with the K3 and KPA500. Although not strictly required, the E850463 Aux cable provides the best integration of the KAT500, KPA500 and K3 equipment.

In addition to the supplied cables, you need two E850463 Aux cables. Normally you will have one already connected between your K3 and KPA500, so you may need one additional cable. This is the same cable included in the KPAK3AUX cable set. You can purchase the cable from Elecraft (order E850463) or, you can construct your own cable using male and female DB-15 connectors wired as follows.

⚠ IMPORTANT

Do not use standard VGA cables. The E850463 Aux cables are wired differently.

Table 1. E850463 Aux Cable Wiring

CONNECTOR PINS		SIGNAL
2	2	AUXBUS
3	3	BAND 1
5	5	GND
9	9	BAND 2
10	10	PTT (or KEY)
11	11	Inhibit
12	12	GND
13	13	BAND0
14	14	BAND3
15	15	ALC (Normally not used. See your KPA500 Owner's Manual)

The basic E850463 Aux cabling setup is shown in Figure 1. If your station setup requires that other equipment (e.g. SteppIR controller) have access to the key line to inhibit the amplifier, use the cabling described in Figure 2.

① 50-ohm coaxial RF cables with PL-259 connectors.

- Be sure you select the antenna output on the K3 that connects to the KPA500.
- The KAT500 allows up to three antenna connections, selected from the front panel (See *Operation*, page 25).

② Two wire power cable with a female 2.1 mm coaxial connector.

- Connect to the station 11 to 15 VDC power supply with the white striped lead to the positive terminal.

③ Computer interface cable.

- Not required but used for controlling the KAT500 from a personal computer, customizing the KAT500's operation or for updating firmware (see *Utility* program on page 29).

④ E850463 Aux interface cables with male and female connectors.

- Do not use common VGA cables; they are not wired correctly for this use. You can order E850463 from Elecraft or you can make your own (See *E850463 Aux Cable Wiring*, above).

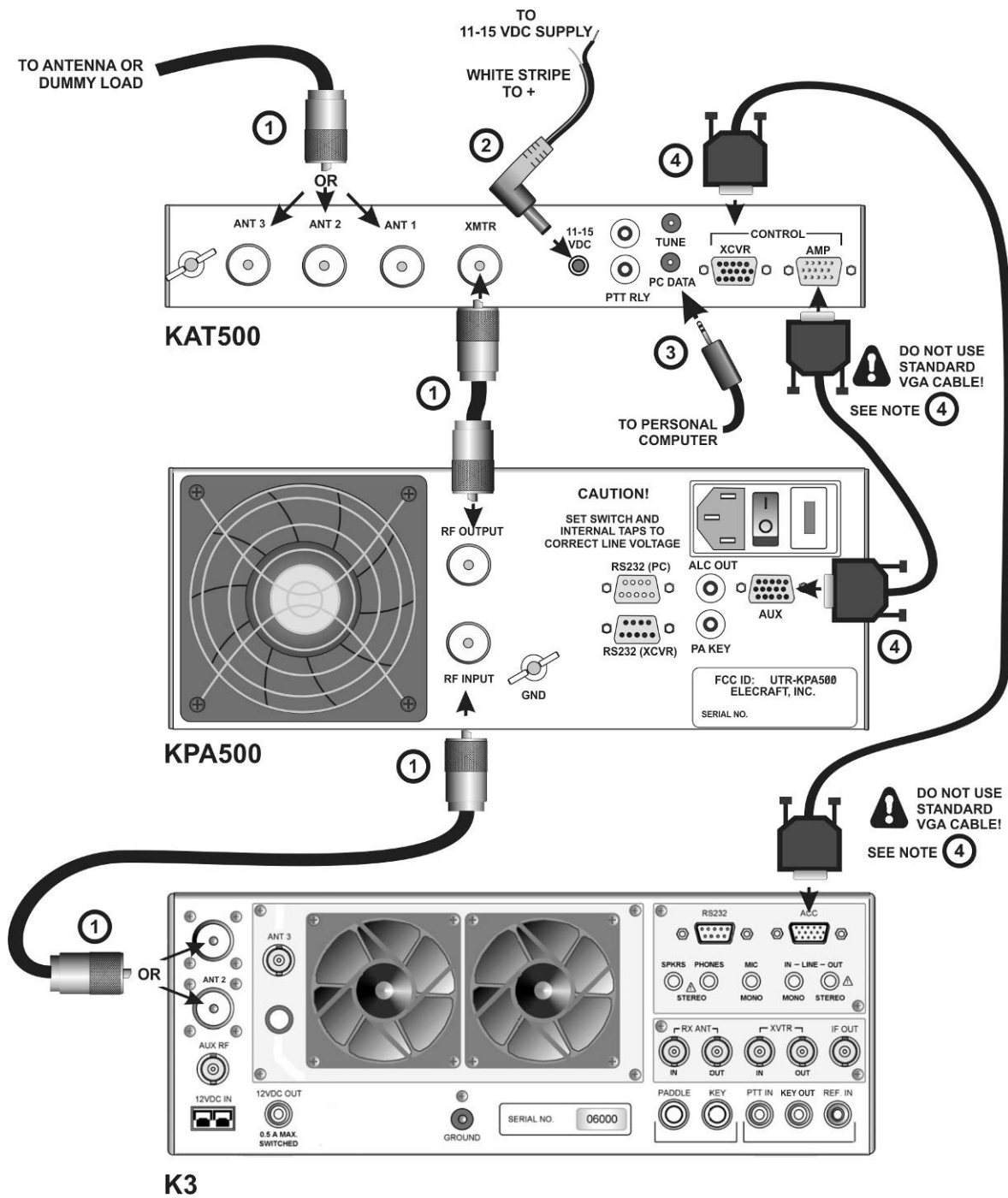



Figure 1. Cabling Diagram: Elecraft K3, KPA500 and KAT500 Using E850463 Aux Interface Cables.

⑤ Key Line Cables

- The Key Line (sometimes called a PTT line) controls the amplifier, enabling it for normal transmission and inhibiting it when necessary to protect the amplifier other equipment. The key line consists of a two conductor (center wire and shield) cable and connects to the Elecraft equipment using RCA phono male connectors.
- The K3 transceiver grounds the Key line to enable the KPA500 amplifier. Opening this line anywhere between the K3 and the KPA500 will inhibit the amplifier. If you have an external device that must control the key line, such as a SteppIR controller, you may insert it series with the key line in either place indicated with the  using connectors that match those on the external device.
- If you need additional cables, you can make your own or order additional cables from Elecraft (part number E100416). The Elecraft cables use RG59 coaxial cable for optimum shielding against incidental RF pickup.

IMPORTANT

When using a separate Key Line cable, you must:

- 1. Interrupt the key line in the E850463 Aux cable as described in note ⑥ below.**
- 2. Use a separate key line cable between the transceiver and between the KAT500 and between the KAT500 and the amplifier. You cannot use an E850463 Aux cable in one location and a separate key line cable in the other.**

⑥ Key Line Interrupter

- The E850463 Aux Cable includes the key line that enables the tuner or amplifier during normal transmission. This circuit must be broken when using an external key line cable or the key line in the E850463 Aux cable will bypass the external equipment cable and will not inhibit the amplifier.
- If you purchased the Elecraft KPAK3AUX cable set, the included Key Line Interrupter “opens” the key line so the E850463 cable does not have to be modified.
- If you purchased only the E850463 Aux cables, you can order a key line interrupter separately. Order E850462 from parts@elecraft.com
- If using a homemade cable, you can cut the circuit at pin 10 (see *Table 1. E850463 Aux Cable Wiring* on page 4)

Other Transceiver and Amplifier or Stand-Alone Transceiver

The KAT500 works well with any HF transceiver covering 1.8 through 54 MHz and amplifier delivering up to 1,000 watts output (see *Specifications*, page 2). If you have an Elecraft K3 transceiver and KPA500 amplifier you can connect them to the KAT500 as shown here.

However, for best integration of the K3 equipment, we recommend that you use the E850463 Aux Interface Cable as shown in Figure 1 or Figure 2.

The basic cabling requirements for a transceiver and amplifier combination are shown in Figure 3. Refer to the following notes for details of the connections.

① 50-ohm coaxial RF cables with PL-259 connectors.

- The KAT500 allows up to three antenna connections, selected from the front panel (See *Operation*, page 25).

② Two wire power cable with a female 2.1 mm coaxial connector.

- Connect to the station 11 to 15 VDC power supply with the white striped lead to the positive terminal.

③ Computer interface cable.

- Not required but used for controlling the KAT500 from a personal computer, remote operation, customizing the KAT500's operation or for updating firmware (see *KPA Utility* program on page 29).

④ Key Line Cables

- The Key Line (sometimes called a PTT line) controls the amplifier, enabling it for normal transmission and inhibiting it when necessary to protect other equipment. The key line consists of a two conductor (center wire and shield) cable and connects to the KPA500 using RCA-type male connectors. You'll need to equip your cables with whatever connector types are used on the transceiver and amplifier.
- If you have an external device that must control the key line, you may insert it series with the key line in either place indicated with the  using the appropriate connectors.

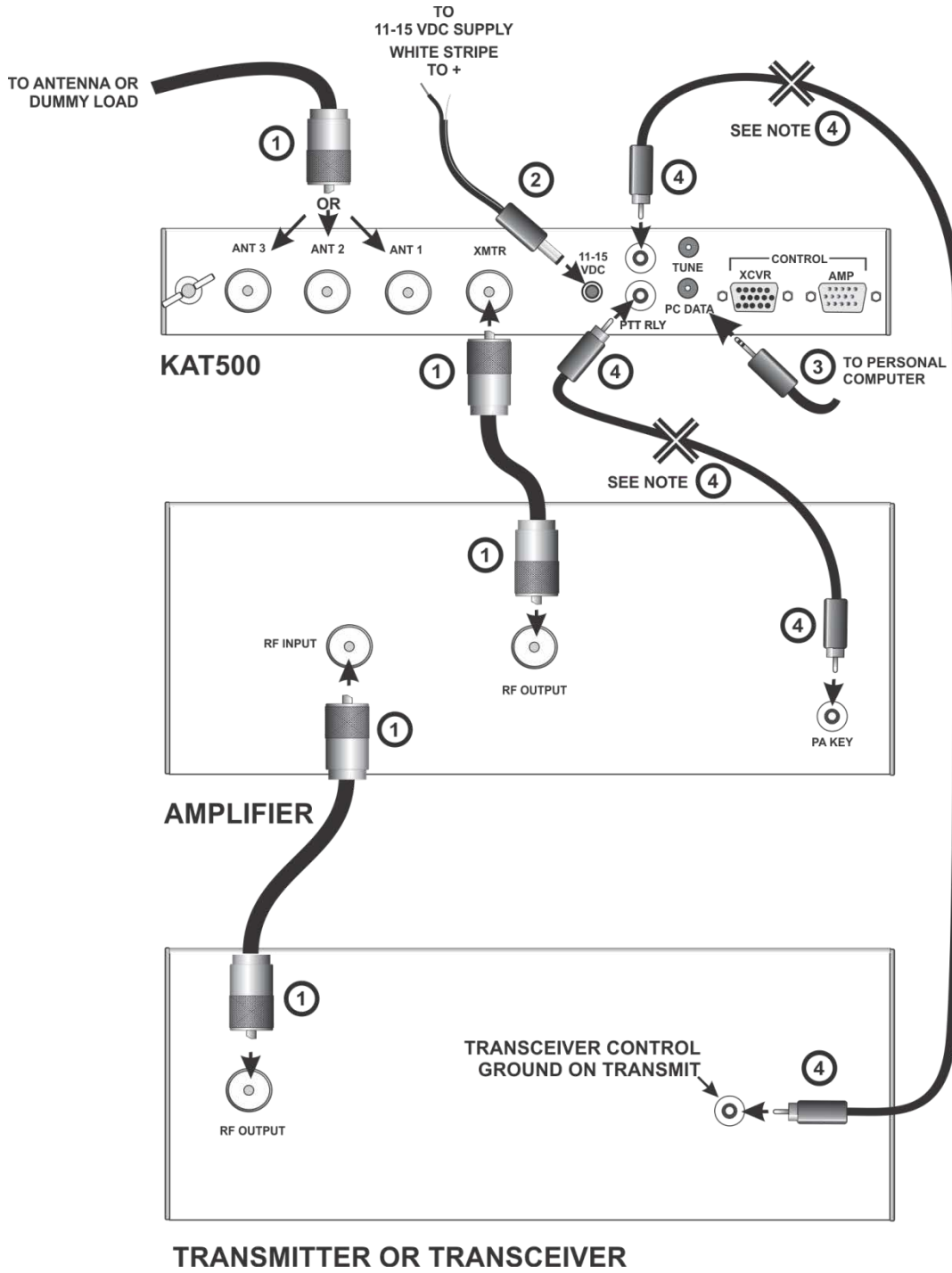

Figure 3. Cabling Diagram: Elecraft KAT500 with Non-Elecraft Amplifier and Transceiver.

Flex 6000-Series Transceivers

The Elecraft KPA500 and KAT500 easily interfaces with transceivers featuring serial protocol, providing “Enhanced Mode” functionality that informs the amplifier and tuner of frequency changes as soon as they are made by the transceiver.

Cabling

Refer to Figure 4. Four interface cables are required:

- 1) Male phono-to-phono cable (provided with the KAT500) ②
- 2) Male phono-to-phono cable (provided with the KPA500) ③
- 3) Elecraft KXUSB cable ④
- 4) Elecraft KUSB cable and null modem adapter ⑤

For transmit keying, the phono-to-phono plug cables provided with the KPA500 and KAT500 connect between the transceiver’s keying output jack, the PTT RLY jacks on the KAT500 and the KEY IN jack on the KPA500.

Flex uses different names for this keying output jack, depending upon the radio.

Table 2. Flex Radio Keying Connector Names

Flex Model	Keying Output Connector
6300	TX
6400/6500(M)	TX1, TX2, TX3
6700/6800(M)	Out1, Out2, Out3

- ① 50-ohm coaxial RF cables with PL-259 connectors.
 - Be sure your transceiver is configured to deliver power to the antenna output that connects to the KPA500.
 - The KAT500 allows up to three antenna connections, selected from the front panel (See *Operation*, on page 25).
- ② KAT500 PTT RLY phono jack to KPA500 PA KEY phono jack.
- ③ KAT500 PTT RLY phono jack to Flex Keying Output connector.
- ④ KAT500 PC DATA 3.5mm TRS jack to Flex USB port.
- ⑤ KPA500 RS232 (XCVR) port to null modem adapter, then to Flex USB port.

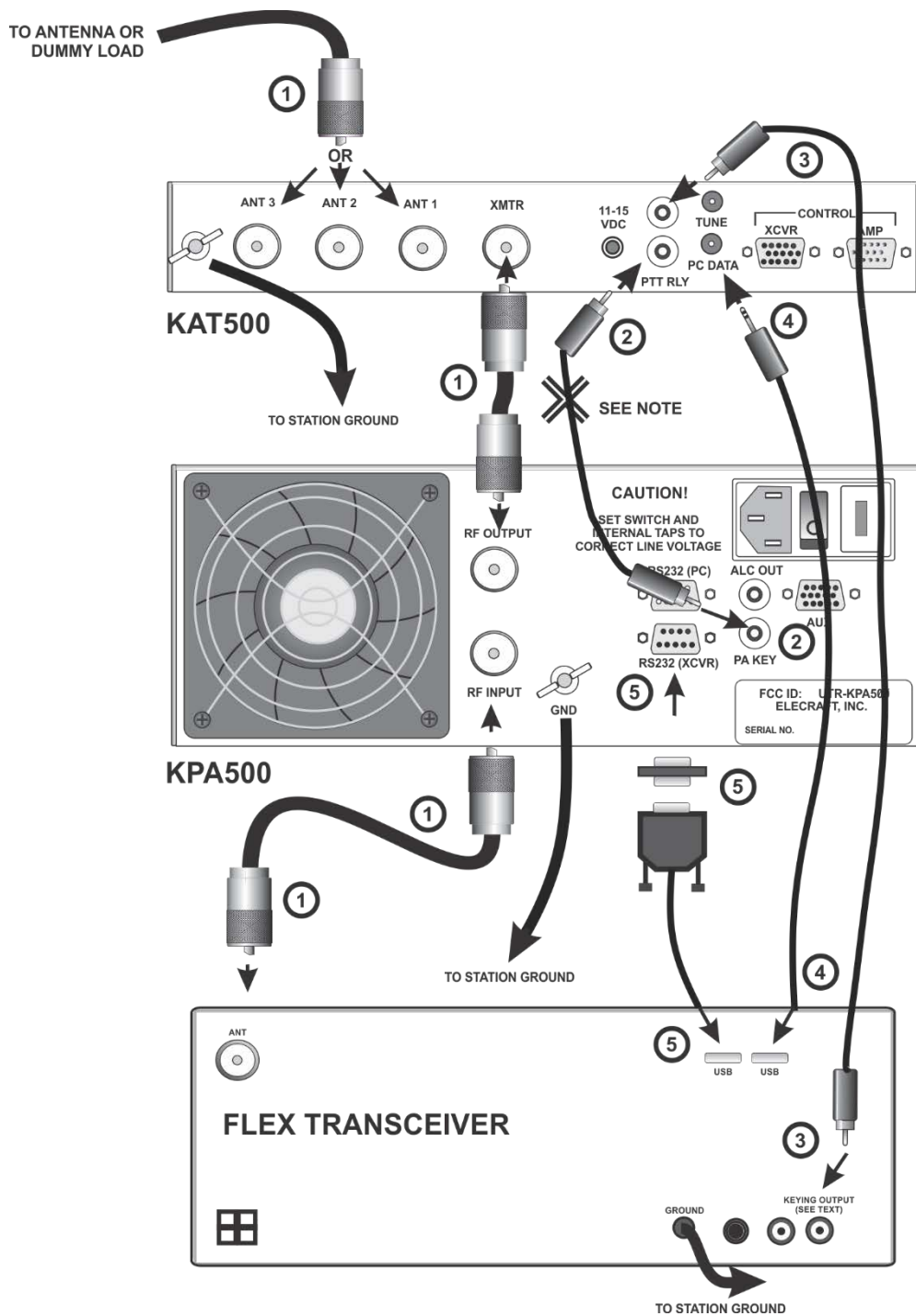

Figure 4. Cabling Diagram: Elecraft KAT500, KPA500 and Flex 6000-Series Transceiver.

SmartSDR Settings

 *Note: SmartSDR version 2.1 or higher is required.*

Using SmartSDR, configure the Flex port that is created by plugging in the USB cable.

Select Settings → USB Cables and confirm the two new CAT cables are recognized. Select the first of these new CAT cables and then click on Edit. Confirm you have the following values:

- Name: New CAT Cable
- Cable Type: CAT
- Source: TX Slice
- Auto-Report: Enabled

Click on Advanced (the down arrow) to expand the dialog window and display the baud rate:

- Speed: 38400
- All others: Leave at their defaults (8 bits, no parity, one stop)

Repeat these steps for the second new CAT cable.

Test operation by changing bands on the transceiver. The KPA500 should quickly follow and change bands. As you tune your transceiver, the KAT500 will follow and automatically select the correct ATU tuning solution, even before transmitting.

If the amplifier does not follow the radio, make sure that the KUSB and KXUSB are recognized by the Flex transceiver. All cables must be fully plugged into all units, and confirm the baud rate is set to the same value on both the transceiver and the KPA500.

Icom Transceivers with AH-4 ATU Interface

Icom transceivers equipped with the AH-4 interface can operate the KAT500.

The Interface Cable includes the Key Line (sometimes called a PTT line) which controls the amplifier, enabling it for normal transmission and inhibiting it when necessary to protect other equipment.

The transceiver grounds the Key line to enable the KPA500 amplifier. Opening this line anywhere between the transceiver and the KPA500 will inhibit the amplifier.

Wire the Molex connector cable as shown in Table 3, *Icom AH-4 Interface Cable Wiring*.

Icom transceivers not equipped with the AH-4 interface can use the KAT500 as described under *Other Transceiver and Amplifier or Stand-Alone Transceiver* on page 8.

Cabling

Cable and connector information.

Table 3. Icom AH-4 Interface Cable Wiring

MOLEX CONNECTOR TO ICOM TRANSCEIVER	SIGNAL	TRS CONNECTOR TO KAT500	POWER CONNECTOR TO KAT500
Pin 1	Key	Tip	NC
Pin 2	Start	Ring	NC
Pin 3	+12 VDC	NC	Center
Pin 4	Ground	Sleeve	Outer Shell

NOTES:

- Molex Connector: Pin 1 is at the triangular end of the connector.
- TRS is tip, ring and sleeve on a 3.5mm “stereo” plug. NC = No connection.
- Power Connector is a 2.1mm barrel type connector. NC = No connection.

Table 4. Icom Key Line Cable Wiring

DIN CONNECTOR TO ICOM TRANSCEIVER	SIGNAL	PHONO CONNECTOR TO KAT500	POWER CONNECTOR TO KAT500
Pin 3	HSEND	Tip	NC
Pin 2	Ground	Shell	NC

NOTES:

- The DIN connector varies with the model of Icom transceiver. See your owner’s manual for the specific connector required.

① 50-ohm coaxial RF cables with PL-259 connectors.

- Be sure your transceiver is configured to deliver power to the antenna output that connects to the KAT500.
- The KAT500 allows up to three antenna connections, selected from the front panel (See *Operation*, on page 25).

② **DC power to the KAT500.**

③ **Key Line Cables.**

- The Key Line (sometimes called a PTT line) controls the amplifier, enabling it for normal transmission and inhibiting it when necessary to protect the amplifier other equipment.
- The key line between the KPA500 and the KAT500 consists of a two conductor (center wire and shield) cable and connects to the Elecraft equipment using phono type male connectors.
- The key line between the KAT500 and the Icom transceiver must be wired as shown in on page 15.

④ **External Device Controlling the Key Line.**

- If you have an external device that must control the key line, you may insert it series with the key line an either place indicated with the  using the appropriate connectors to match the external device.

⑤ **Computer Interface Cable.**

- Not required but used for controlling the KAT500 from a personal computer, customizing the KAT500's operation or for updating firmware (see *Utility Program* on page 29).

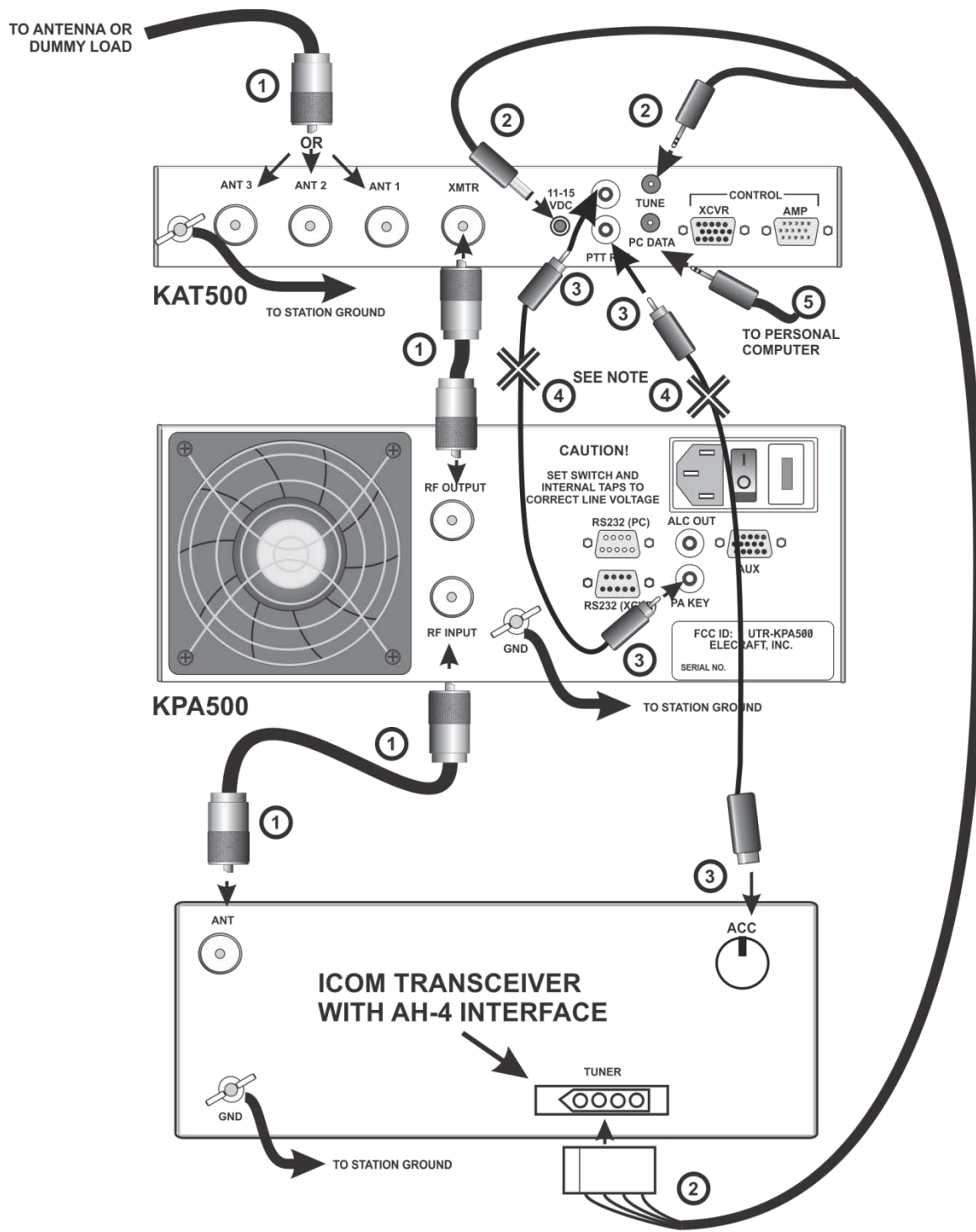

Figure 5. Cabling Diagram: Elecraft KAT500, KPA500 and Icom Transceiver with AH-4 Tuner Interface.

Kenwood Transceivers with USB Interface

The Elecraft KAT500 tuner and KPA500 amplifier easily interfaces with Kenwood transceivers featuring serial protocol, providing “Enhanced Mode” functionality that informs the tuner and amplifier of frequency changes as soon as they are made by the transceiver.

Recent Kenwood HF radios have both a USBus and DE9 serial ports, while older radios do not have the USBus port. Frequency information is transferred using the Elecraft CBL-KENSER500 cable.

Cabling

Refer to Figure 6. When connecting the Kenwood transceiver to the KAT500 only:

- 1) Elecraft CBL-KENKEY ③
- 2) Elecraft CBL-KENSER500 cable ④

When connecting the Kenwood transceiver to both KAT500 and the KPA500:

- 1) Male phono-to-phono cable (provided with the KAT500) ②
- 2) Elecraft CBL-KENKEY ③
- 3) Elecraft CBL-KENSER500 ④

In either case, the Kenwood radio must be configured to supply data to the KAT500 and/or KPA500.

- ① 50-ohm coaxial RF cables with PL-259 connectors.
 - Be sure your transceiver is configured to deliver power to the antenna output that connects to the KPA500.
 - The KAT500 allows up to three antenna connections, selected from the front panel (See *Operation*, on page 25).
- ② KAT500 PTT RLY phono jack to KPA500 PA KEY phono jack.
- ③ KAT500 PTT RLY phono jack to Kenwood REMOTE jack using the CBL-KENKEY cable.
- ④ KAT500 PC DATA 3.5mm TRS jack to Kenwood SERIAL DE-9 connector using the CBL-KENSER500 cable.
- ④ CBL-KENSER500 cable DE-9 connector to KPA500 RS232 (XCVR) DE-9 connector.

Table 5. CBL-KENSER500 Kenwood Data and Control Interface Cable Wiring

DE-9F to Kenwood Transceiver	DE9F to Elecraft KPA500	3.5mm TRS to Elecraft KAT500
2	2	Tip
3	3	N/C
5	5	Sleeve
7*		
8*		

*Pins 7 and 8 connected together

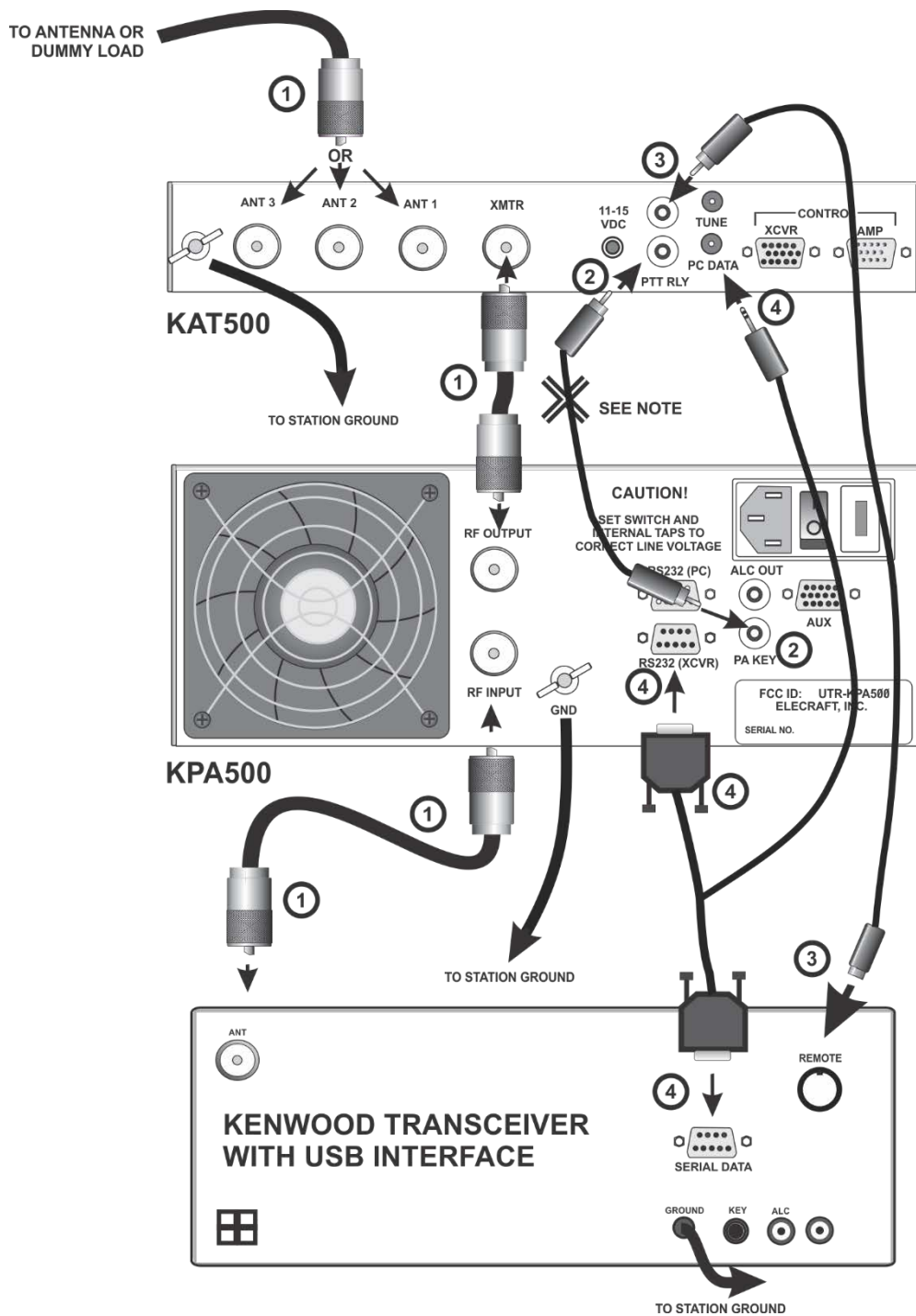

Figure 6. Cabling Diagram: Elecraft KAT500, KPA500 and Kenwood Transceiver with USB Interface.

Transceiver Menu Settings

Referring to the transceiver's operating manual, open the transceiver's menu. Menu item numbers shown are for the TS-590. Other radios have similar menu items but different numbers.

Access the serial port setup menu items and confirm the following:

Table 6. Kenwood Transceiver Menu Settings

TS-590 Menu Item	Setting	Description
59 HF LINEAr control enable	2	Enable Amplifier key line, HF
60 50MHZ Llinear control enable	2	Enable Amplifier key line, 6m
64 TRANSFER split function	ON	
65 COPYSPLit frequency	ON	
67 COM PORT baud rate	38400	

Exit the menu and power cycle the radio to lock in the changes.

KAT500 Configuration

The KAT500 does not require any configuration changes.

KPA500 Configuration

Turn the KPA500 on and access its menu by holding MENU.

Using the down-arrow key to the right of the display, scroll to RADIO.

Hold the EDIT button and use the down arrow to select "SERIAL".

Tap CURRENT to exit the edit mode.

Tap the down arrow until RS232 XCVR appears.

Hold EDIT and select 38400 bps.

Press MENU again to exit EDIT.

Now scroll down to SER POLL.

Hold the EDIT button and use the up arrow to select "ON".

Tap HV then hold MENU to exit the KPA500 menu.

Test operation by changing bands on the transceiver. The KPA500 should quickly follow and change bands. As you tune your transceiver, the KAT500 will follow and automatically select the correct ATU tuning solution, even before transmitting.

If the amplifier does not follow the radio, make sure all cables are fully plugged in on all three units, and then confirm the baud rate is set to the same value on both the transceiver and the KPA500.

Yaesu Transceivers with BCD Band Data

The Elecraft KAT500 and KPA500 easily interface with radios featuring BCD (binary coded decimal) band data protocol. Elecraft offers cables that take advantage of the BCD band data to select the proper operating band before the first transmission is made.

Yaesu radios have several connector configurations.

Large radios are usually equipped with a KEY OUT phono jack and a standard DIN connector for BCD band data.

Small Yaesu radios usually do not have a phono jack but use MiniDIN connectors for interfacing. It is important to know that the MiniDIN connectors differ in function and pin-out depending on model, so make sure to obtain the appropriate cable as shown in Table 7.

The DIN connectors include a KEY OUT function, so RCA phono cables are not required.

Table 7. Elecraft Cables for Yaesu Transceivers

Transceiver	Connector Name/Type	Elecraft Cable
Large Desktop (FT1000, FT5000, FT9000, etc.)	BAND DATA	CBL-YAE-BANDKEY
FT-450, FT-950, FT-1200	TUNER or LINEAR, 10-Pin MiniDIN	CBL-YAE-BKDIN10
FT-857, FT-891, FT-897, FT-991	TUN/LIN, 8-Pin MiniDIN	CBL-YAE-BKMINI
FT-817, FT-818*	ACC, 8-Pin MiniDIN*	CBL-YAESUKEY*
FTDX-3000	LINEAR, DA-15	CBL-YAE-BKDA15

*FT-817, FT-818 do not supply BCD band data, CBL-YAESUKEY is used only for the KEY OUT function.

Table 8. CBL-YAE-BKDA15 Yaesu Data and Control Interface Cable Wiring

DA15M to Yaesu Transceiver	DE15M to Elecraft KPA500	Function
1	N/C	N/C
2	10	Key IN (PTT)
3	5	GND
4	13	Band 0 In
5	3	Band 1 In
6	9	Band 2 In
7	14	Band 3 In
8	12	GND
9, 10, 11, 12, 13, 14, 15	2, 4, 6, 7, 8, 11, 15	N/C

Cabling

Two different interface systems are possible.

Keying-Only

Refer to Figure 7. For “keying only,” the transceiver KEY OUT signal enables the tuner and amplifier for transmit mode.

For large Yaesu radios with KEY OUT phono jacks, connect a phono cable between the radio and the KAT500 PTT RLY jack.

Small radios equipped with a MiniDIN connector do not require a phono cable. (The DIN connector includes a KEY OUT function.) Connect the Elecraft CBL-YAESUKEY between the radio MiniDIN connector and the PTT RLY phono jack on the KAT500. When including the KPA500, connect a phono cable between the KAT500 PTT RLY jack and the KPA500 PA KEY jack.

- ① 50-ohm coaxial RF cables with PL-259 connectors.
 - Be sure your transceiver is configured to deliver power to the antenna output that connects to the KPA500.
 - The KAT500 allows up to three antenna connections, selected from the front panel (See *Operation*, 25).
- ② Connect a phono cable from the KAT500 PTT RLY jack to the KPA500 PA KEY phono jack. If an external accessory must control the amplifier key line, insert the connection here.
- ③ For large Yaesu radios: Connect a phono cable between the radio KEY OUT jack and the KAT500 PTT RLY jack. Connect a phono cable from the KAT500 PTT RLY jack to the KPA500 PA KEY phono jack.
- ③ For small Yaesu radios with MiniDIN connectors: Connect the Elecraft CBL-YAESUKEY MiniDIN end to the radio and insert the phono plug into the KAT500 PTT RLY jack. Connect a phono cable from the KAT500 PTT RLY jack to the KPA500 PA KEY phono jack.

Transceiver Menu Settings

No KPA500 or KAT500 configuration is needed for keying-only cable operation.

Test functionality by placing the KAT500 and/or KPA500 into OPER mode and transmitting with the transceiver.

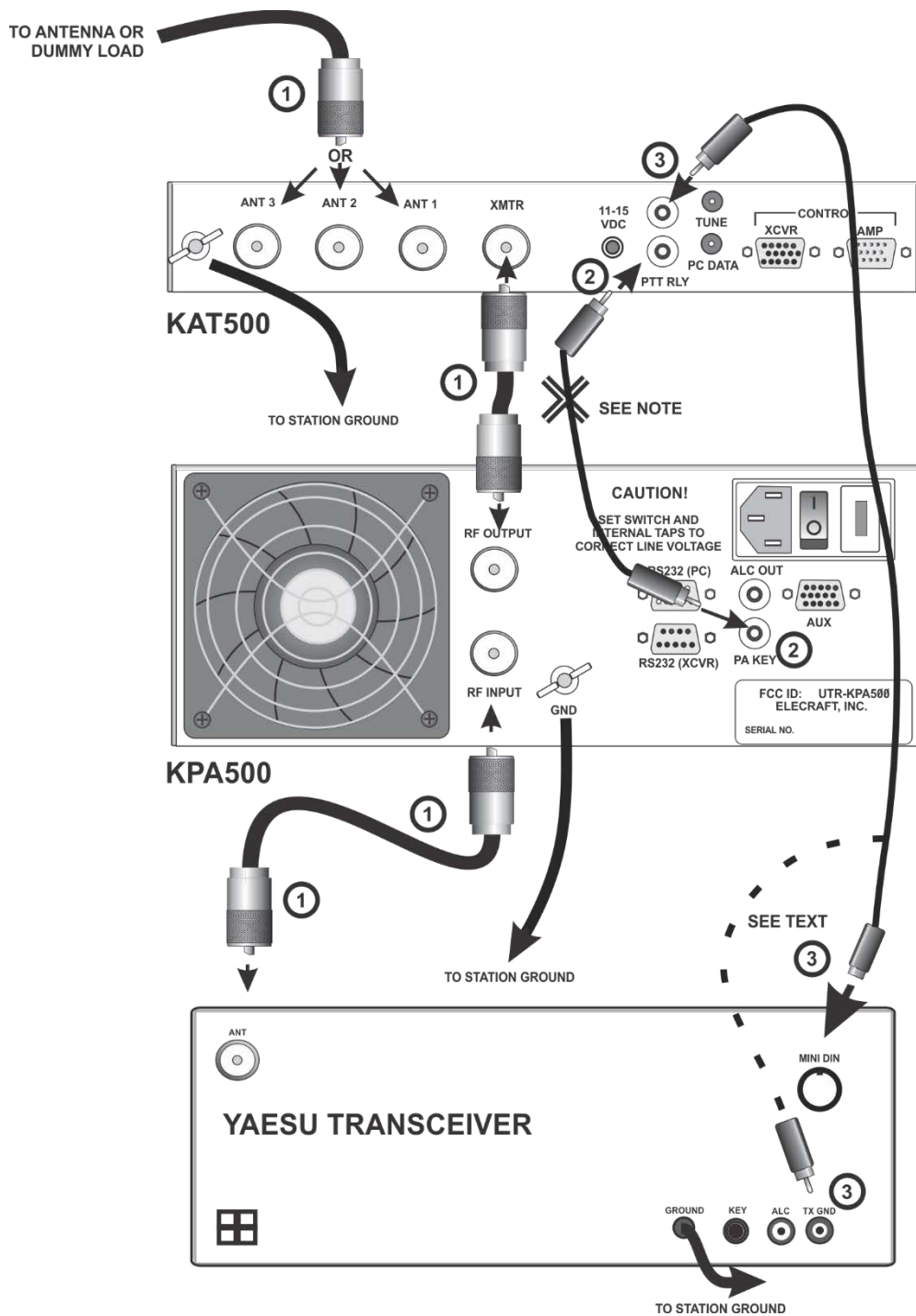

Figure 7. Cabling Diagram: Elecraft KAT500, KPA500 and Yaesu Transceiver for Keying-Only.

Enhanced Operation

Refer to Figure 8. Enabling the transceiver to command the KAT500 and KPA500 to change bands and prepare the amplifier before RF is applied requires an optional band data cable. Select the appropriate cable from Table 7.

The FT-817 and FT-818 do not supply BCD band data, so no frequency control is possible.

Large Yaesu radios feature an 8-pin DIN jack labeled “BAND DATA.” Operating band information and amplifier keying are provided here, so a separate key line via a phono cable is not needed.

Connect the appropriate Elecraft accessory cable to the DIN jack on the radio and the XCVR CONTROL DE15 jack on the KAT500.

Connect an E850463 AUX cable between the AMP CONTROL DE15 and the AUX DE15 jack on the KPA500.

Note that the phono cable is not required for keying.

- ① 50-ohm coaxial RF cables with PL-259 connectors.
 - Be sure your transceiver is configured to deliver power to the antenna output that connects to the KPA500.
 - The KAT500 allows up to three antenna connections, selected from the front panel (See *Operation*, page 16).
- ② KAT500 XCVR CONTROL DE15 connector to Yaesu BCD interface.
- ③ KAT500 AMP CONTROL connector to KPA500 AUX connector.

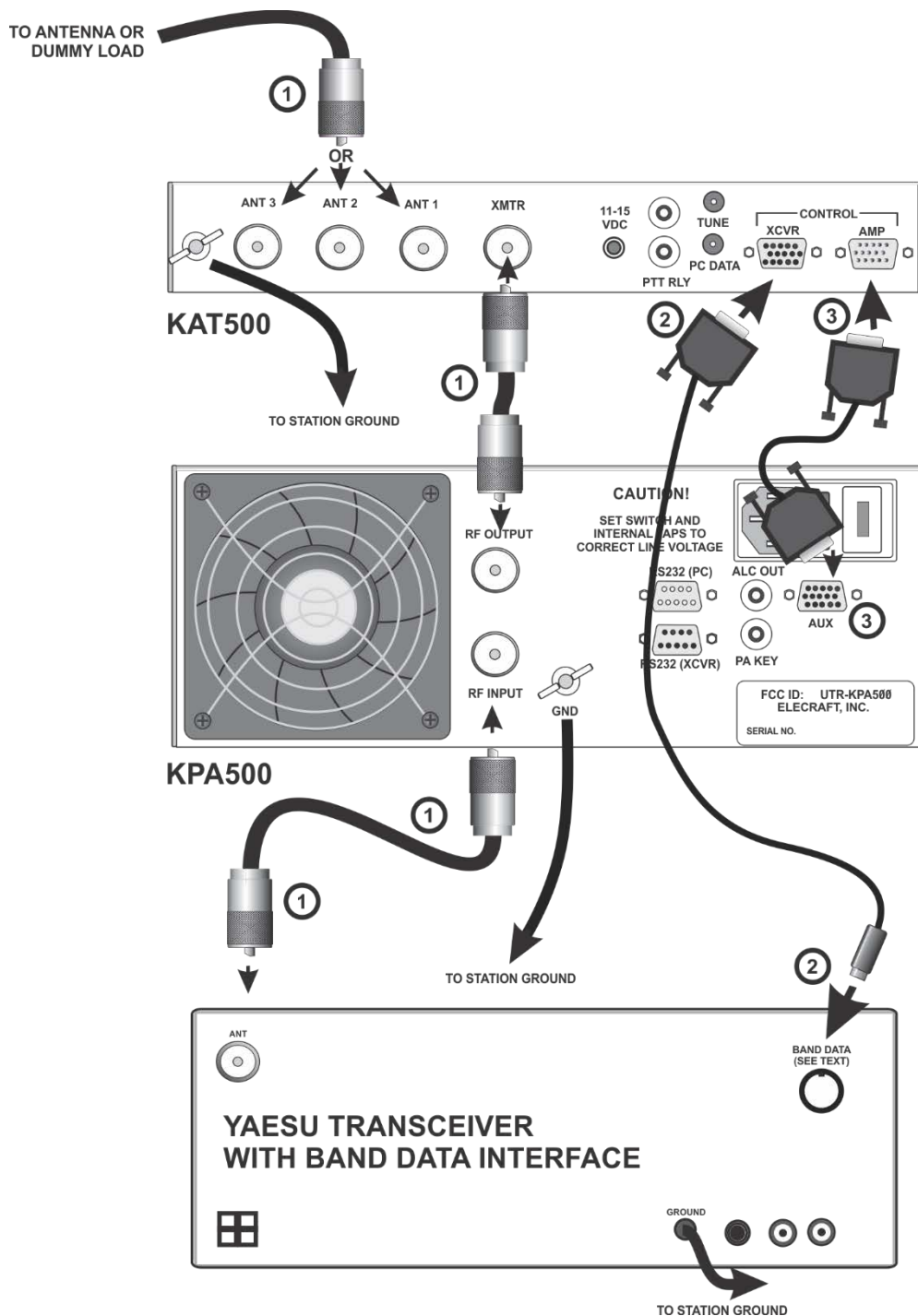

Figure 8. Cabling Diagram: Elecraft KAT500, KPA500 and Yaesu Transceiver with Band Data DIN Connector.

Transceiver Menu Settings

No menu configuration is necessary for the large Yaesu radios.

On some of the small transceivers, specifically the FT-857 and FT-897, the MiniDIN jack may be programmed for multiple functions. Refer to the transceiver manual to set the MiniDIN jack to the "LINEAR" mode to enable either or both KAT500 and KPA500 operation.

Turn the KPA500 on and access its menu by holding MENU.

Using the down-arrow key to the right of the display, scroll to RADIO.

Hold the EDIT button and use the down arrow to select “BCD”.

Tap CURRENT to exit the edit mode.

Tap HV then hold MENU to exit the KPA500 menu.

No configuration is necessary for the KAT500.

Test operation by changing bands on the transceiver. The KAT500 will automatically select the antenna jack and last frequency segment used in that band. The KPA500 amplifier should instantaneously follow and change bands, before transmitting.

If the amplifier does not follow the radio, make sure all cable connectors are fully seated and confirm the radio band data jack is configured in “LINEAR” mode.

Operation

The KAT500 turns on automatically when power is applied. You can turn the KAT500 off from the front panel by holding the MODE switch. A brief tap on the MODE switch will turn the KAT500 on again.

⚠ IMPORTANT!

- **IF YOUR TRANSCEIVER OR AMPLIFIER HAS A BUILT-IN ATU**, be sure it is in bypass before attempting to use the KAT500.
- **IF YOU ARE USING THE KAT500 WITH A K3 CONNECTED USING THE E850463 AUX CABLE**, apply power to the KAT500 before or at the same time you turn the K3 on. If you turn the K3 on first the K3 may not initialize until you apply power to the KAT500.

Front Panel Controls and Indicators

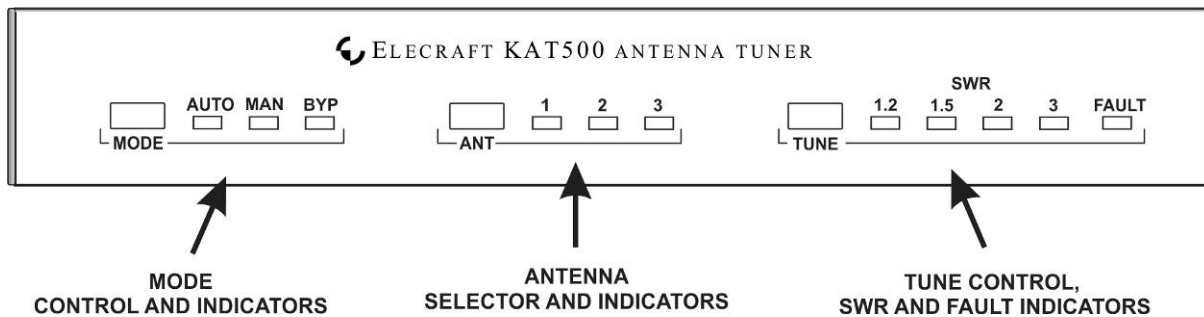

Figure 9. KAT500 Front Panel Controls.

The KAT500 is normally operated using the simple front panel controls. Optionally, it can be operated using the *Utility* program (See *KAT500 Utility* program, on page 29).

Mode Control and Indicators. Tap the MODE switch to select:

1. **AUTO** (Automatic): When at least 7 watts of RF is present and the SWR is greater than a predetermined limit, the KAT500 automatically initiates a tune cycle to find a setting that produces a low SWR. (See *Tune Operation* on page 27 for a description of what happens during the tune cycle.)

The predetermined SWR limit at which an automatic tune cycle begins can be chosen using the *Utility* program. The default SWR value is 1.8:1.

This mode may be useful for remotely controlled stations that do not include a way to initiate a tune cycle.

2. **MAN** (Manual): A tune cycle can be initiated manually as described under *Tune Control, SWR and FAULT Indicators* below.

This is the preferred normal mode. The KAT500 will recall tune settings for the antenna and frequency in use. If the SWR is dangerously high, the KAT500 will open the key line to disable the amplifier or transmitter.

3. **BYP** (Bypass): RF is passed straight through the KAT500, bypassing the tuning elements in the matching network. The RF does pass through the SWR bridge so the SWR seen at the input to the antenna feed line is displayed. Also, the KAT500 will switch to the antenna chosen for each band (see *Antenna Selector and Indicators* below). Whenever power is off, the KAT500 switches to BYP and ANT 1.

Antenna Selector and Indicators. Until you choose a different antenna, the KAT500 uses antenna 1 on all bands.

1. Tap the ANT switch to select the desired rear panel antenna connection: 1 (ANT 1), 2 (ANT 2), or 3 (ANT 3):
2. The antenna selection is remembered for each band, so the KAT500 will automatically return to the chosen antenna when the KAT500 returns to that band.
3. The KAT500 switches to ANT 1 whenever the power is off.
4. Antenna connections have bleeder resistors that drain off accumulated static from rain, wind, etc.

Tune Control, SWR and FAULT Indicators. Tap the TUNE switch to manually initiate a tune operation that will search for the settings needed to produce a low SWR. To cancel a tune operation, tap the TUNE switch a second time. When initiating a tune operation:

1. The indicator for the mode selected (AUTO or MAN) flashes.
2. If the KAT500 was in BYP mode, it will automatically switch to MAN mode.
3. The KAT500 opens the key line to disable the external amplifier provided the RF power present is less than the limit specified for hot-switching (see *Key Line Hot Switching* below).
4. The tune operation begins when 7 watts or more of RF is applied (see *Tune Operation* below for details of what happens during tuning).
5. The SWR LEDs indicate how well the KAT500 has matched the antenna to the transceiver. Typically an indication of 1.5 or lower is considered a good match. The FAULT indicator will light if an abnormal condition occurs (see *Fault Conditions* on page 32).
6. The KAT500 closes the key line to enable the amplifier provided the RF power is below the limit specified for Key Line Switching (see below) and the SWR is below 2.0. If the SWR is above 2.0 the KAT500 will hold the key line open to protect the amplifier.

Optionally you can initiate a tune operation through the rear panel TUNE jack with a transceiver using the AH-4 protocol or by momentarily shorting the ring to ground. Also, a tune operation can be initiated through the RS232 port using the KAT500 *Utility* program (page 29).

Key Line Hot Switching

KAT500 is pre-configured so the key line will not be switched if 30 watts or more of RF power is present. This protects many (non-Elecraft) amplifiers from damage. This value may be changed to match the key line switching capability of any amplifier using the *Utility* program (page 29).

The Elecraft KPA500 is designed to have its key line switched to disable or enable the amplifier even while it is producing full RF power.

Tune Operation and Memories

Tune Operation

A tune operation begins when RF power between 7 and 100 watts is applied and the SWR is above the tuning threshold in AUTO mode, or when the TUNE switch is tapped in either AUTO or MAN modes. The RF power must be below the key line hot switching limit (see *Key Line Hot Switching*, above) so the KAT500 can disable the amplifier. The KAT500 will not respond to less than 7 watts of drive and over 100 watts will cause a fault condition (see *Fault Conditions*, on page 32)

Relays in the KAT500 operate to search for values of inductance (L) and capacitance (C) that match the impedance of the antenna to 50 ohms non-reactive for the transceiver.

The SWR LEDs indicate how close the antenna impedance is matched to the transceiver. The L and C values switched in will provide a good match for most situations, but if you feel the resultant SWR is high you can tap TUNE again within 3 seconds to initiate a second, fine tuning process in which smaller changes in L and C values are tried. That may result in a lower SWR. You can also manually adjust the L and C values using the *KAT500 Utility* program (on page 29).

If you have a high-Q (narrow bandwidth) antenna that benefits from a fine tune operation on certain bands, you can configure the KAT500 to automatically do a fine tune operation without pressing the TUNE switch again with the *Utility* program (see page 29).

If the SWR is 1.2 or less when a tune operation begins, the KAT500 bypasses the matching network without searching for a tuning solution. The KAT500 remains in either AUTO or MAN mode but the matching network is switched out of the RF path (bypassed). The bypass setting will be stored as the tuning solution so the matching network will be bypassed whenever you return to that frequency. This SWR threshold can be changed with the *Utility* program (see *VSWR Thresholds* page 30 and *Automatic Bypass on Selected Bands*, page 31).

Memories

After successfully tuning, the KAT500 stores the L and C settings or the bypass setting in memory. They will be recalled almost instantly when returning to that frequency later. The entire spectrum from 1.8 through 60 MHz is divided into frequency segments and tuning information is stored for each segment in which you have successfully completed a tune operation.

When starting a tune operation for a frequency segment that has no previously stored L and C values, the KAT500 first tries the settings in the nearest frequency segment that has tuning data.

Since retuning is normally required over a narrower frequency range on the lower frequencies to maintain a low SWR, the lower frequencies have narrower segments assigned as follows:

- Below 3 MHz the segments are 10 kHz wide.
- From 3 MHz through 26 MHz the segments are 20 kHz wide.
- From 26 MHz to 38 MHz the segments are 100 kHz wide.
- From 38 MHz to 60 MHz the segments are 200 kHz wide.

The KAT500 also stores the antenna output that you selected for each band.

Frequency Tracking with an Elecraft K3 Transceiver

When the KAT500 is used with an Elecraft K3 transceiver, the K3 can be configured to cause the KAT500 to follow changes in the K3's VFO frequency during receive. The KAT500 will change to the tuning solution for each frequency segment as the K3's VFO frequency is tuned across the band. To use frequency tracking:

- Ensure that your K3 is equipped with firmware revision 4.82 or later. See Firmware Upgrades in your K3 Owner's Manual for instructions about how to upgrade your firmware, if needed.
- Enable the frequency tracking function at the K3: select *CONFIG:KAT3* and then tap the switch to toggle between *KAT500N* (no KAT500) and *KAT500Y* (KAT500 connected and frequency tracking enabled).

Band Switching

Elecraft K3 and KPA500 Amplifier Combination

When using the KAT500 with an Elecraft K3 transceiver and KPA500 amplifier connected with the E850463 Aux interface cable, the KAT500 changes bands when you change bands at the K3. The mode selected (AUTO, MAN or BYP) applies to all bands. Only the ANT selection and the L/C settings are stored in memory and recalled for each band.

Non-Elecraft Amplifiers

Change bands as follows to avoid damage to your amplifier:

- Switch the transceiver to the new band.
- Switch the amplifier to the new band.
- Apply RF power between 7 and 30 watts (see note 1 below). This will cause the KAT500 to change bands, switch to the last used antenna on that band (see note 2 below), switch to the tuning values for that frequency stored in memory or perform a tune cycle, if in AUTO mode. If a tune cycle is performed, 20 watts or more will produce more accurate tuning.
- If your amplifier requires manual tuning, connect it to a suitable dummy load. (You can attach the dummy load to one of the KAT500 antenna connectors, switch the KAT500 to BYP and select that connector with the ANT switch.)
- Tune up your amplifier into the dummy load per the manufacturer's instructions.
- When finished return the KAT500 mode to AUTO or MAN and, if needed, change back to the original antenna selection.

Notes:

1. At 30 watts and above the KAT500 will refuse to open the key line to protect amplifiers that cannot be "hot switched". That is the default value. If your amplifier is capable of handling higher powers, you can change this value using the *Utility* program (page 29). The KAT500 will not respond to less than 7 watts of RF power.
2. If you are not using a K3 with an E850463 Aux cable connected between your K3 and the KAT500, you must make the KAT500 change bands by applying RF power. Only a very brief pulse of RF is needed. Failing to make the KAT500 change bands before selecting a different antenna can produce surprising behavior. For example, if you are using ANT 1 on 80 meters and then switch your transceiver to 40 meters where you want to use ANT 2. You see ANT 1 is still selected on the KAT500 so you change it manually. And then, when you

transmit you see the KAT500 jump back to ANT 1. That happens because the KAT500 did not change bands until you transmitted, and then it reverted to the last ANT position used on 40 meters (or to ANT 1 if no other antenna position has been used on that band).

If you use different antennas on different bands without the E850463 Aux cable interface, we recommend that you first set up the KAT500 for the antenna you want to use on each band as follows. Optionally you can assign antenna ports using the *Utility* program (see page 30).

- Select the desired band on your transceiver or transmitter.
- Tap MODE, if necessary, to select MAN.
- Send a brief pulse of RF at a power level of at least 7watts such as a “dah” with paddles at a CW speed under 25 WPM. That switches the KAT500 to the current band.
- Tap ANT to select the desired antenna for that band.
- Continue on to the next band until you have covered all the bands. Note that you do not need to do this on bands using ANT 1 since the KAT500 defaults to ANT 1 if you have not selected another antenna position.

The “KAT500 Utility” Program

To use the *KAT500 Utility* program you will need:

- A personal computer.
- The *KAT500 Utility* program available free from Elecraft at www.elecraft.com.
- The RS-232 cable with a USB connector supplied with your KAT500.

Connect your computer to the KAT500 using the interface cable connected to the PC DATA jack and load the *Utility* program. Click on the PORT tab and select the port your computer is using to communicate with the KAT500. Click on TEST COMMUNICATIONS and you will see a pop-up stating that the *Utility* program is communicating with the KAT500 if everything is working properly.

Detailed operating instructions for the *Utility* program are provided in the *Utility Help* screens.

The following assumes that you have *KAT500 Utility* version 1.13.5.12 or later installed.

KAT500 Configuration

You can configure the KAT500 to best support your installation. Click on the *Utility* program CONFIGURATION tab and then on the Edit Configuration button. After making your choices, click on the APPLY button at the bottom.

Amplifier Key Interrupt Power

Selects the RF power level applied above which the KAT500 will not open or close the key line to disable or enable an external amplifier or other equipment. The default is 30 watts to protect those amplifiers that cannot have the key line switched while they are producing full power without damage. At any setting up to 1499, the KAT500 will open the key line immediately as long as the RF power is below that level, and then close the key line when transmit power drops to zero.

The Elecraft KPA500 amplifier is designed to both open and close the key line at full power without damage. A setting of 1500 will both open and close the key line immediately. Clicking on Optimize for

the KPA500 automatically selects that setting. Before using this setting with other amplifiers, be sure to review your owner's manual carefully to ensure it can withstand having the key line opened and closed at full power.

Idle Sleep

In some installations a 28004.5 MHz signal may be heard from an oscillator in the KAT500. If this is an issue, you can shut it down when it is not needed. Click on *Idle Sleep* to put a check in the radio button. The oscillator will stop running shortly after the last key press or the last data communication with other equipment and restart automatically when needed.

Initial Power

Normally the KAT500 powers on when dc power is applied. Optionally you can remove the check from the *Power On when DC Power Applied* radio button to command the KAT500 to remain off until the MODE switch is tapped.

Antennas

You can select which antenna connectors are active (Enabled) on each band. Antenna connectors are disabled by clicking on the check mark to clear it. Disabling antenna connectors will cause them to be skipped when cycling through the options with the front panel ANT switch or in the *Utility Operate* tab.

You can also select which ANT connector you prefer to use on each band and it will be automatically selected when you return to that band. You can change the selection to any other antenna connector provided it has not been disabled.

VSWR Thresholds

You can set the SWR thresholds above which a tuning cycle will be started in AUTO mode, or below which the KAT500 will bypass the tuning network. Also, you can set an SWR threshold at which the key line will not close to enable the external amplifier to protect it from excessive SWR.

These thresholds can be set the same for all bands, or individual values can be entered for each band. In most installations the length of coax between the transmitter or amplifier and KAT500 will be too short for the SWR to make a significant difference. The main concern is to provide an acceptable match to the transmitter or amplifier. The Elecraft KPA500 amplifier works efficiently into a load SWR of 1.5:1. Suggested values are 1.8:1 to launch an automatic tuning operation and 1.2:1 for bypass.

Erase Memories

You can erase all of the stored tuning memory data for the entire KAT500, or just the memories associated with a particular ANT selection and band.

Auto Fine Tune

Selects bands on which the KAT500 will always do a fine tune operation. This is helpful when you use an antenna with a high-Q (narrow SWR bandwidth) on certain bands to avoid needing to press the MODE switch a second time whenever the KAT500 does a tune operation.

Saving Configuration

You can save the configuration to a file on your computer so that you can restore it quickly without needing to re-enter the data.

Reset to Factory Default

It is possible, though rare, for parameters to become altered in such a way as to prevent the firmware from running correctly. If you suspect this, you can reinitialize parameters to defaults. If you have saved your configuration, you can restore it quickly by clicking on the *Restore Configuration* button.

Operating Tips

Rapid QSY After Antenna Change

For rapid changes between favorite frequencies without a delay to do a tune operation after installing the KAT500 or after making an antenna change, move to each frequency and do a tune operation as part of your setup procedure. When you return to one of those frequencies later, the KAT500 will recall the settings from memory almost instantly; you will hear only a brief relay click as it recalls and switches to the proper settings.

In an extreme case, you could do a tune operation in each frequency segment on each band so that the KAT500 will memorize the settings in advance. Otherwise, as you operate the KAT500 in AUTO mode, it will tune automatically as you visit different bands and frequencies for the first time. It will not need to do a tune operation again when you return to that frequency unless you change your antenna.

Automatic Bypass on Selected Bands

The mode (AUTO, MAN, or BYP) selected for each band is not stored in memory, however you can cause the KAT500 to effectively switch to bypass on certain bands. The mode does not change, but the KAT500 completely bypasses the matching network. This may be desirable if you have antennas for certain bands that are tunable (such as a SteppIR) or that otherwise show a low SWR across the band.

The KAT500 bypasses the matching L/C network when no values are stored in memory and the SWR it presents is below the VSWR thresholds set for each band. You can change these thresholds and erase any L/C settings already memory for those bands using the *KAT500 Utility* program as follows:

- In the *Utility* program under *Configuration/Edit Configuration*, click on the *VSWR Thresholds* tab and set the *Autotune* and *Bypass VSWR* thresholds above that which your antenna will present on each band. Typical values are 2.5: or 3.0:1.
- Click on the *Erase Memories* tab and erase the memory for each band.
- Be sure your antenna is connected and, if necessary, tuned for the band, and then select the desired ANT and perform a Tune operation (see page 27). The KAT500 will perform a brief search and, noting that the SWR the antenna presents is below the threshold you set above, bypass the matching network. The antenna selection and bypass setting will be stored in memory. The next time you return and transmit that band, you will hear a brief click as the matching network is bypassed automatically, even if you are in AUTO mode, as long as the antenna presents an SWR below the thresholds you set above.
- You can verify that the KAT500 matching network is bypassed using the *KAT500 Utility* program. Click on the *Operate* tab and note that a check appears next to *Bypassed* when you transmit even though the KAT500 is in AUTO or MAN mode.

Fault Conditions

A fault will occur if:

- The RF drive power exceeds 110 watts during a tune operation. This protects the relays from damage due to excessive RF power while switching. If this fault occurs, be sure you have the PA Key circuit installed, either through the E850463 Aux cable or using separate key line cables (see *Setup*, page 3). As supplied, your KAT500 will not open the key line if 30 watts or more of RF drive is applied. If your amplifier is capable of switching its key line at greater powers, you can increase the limit using the *Utility* program (see *Amplifier Key Interrupt Power*, page 29).
- The impedance of your antenna is outside of the tuning range so an acceptable match cannot be found that brings the tuned SWR below 1.6:1.
- The impedance of your antenna is outside of the normal tuning range but the KAT500 is able to match it. In that case, the allowable power is reduced as needed to protect the KAT500. You can safely operate at any power less than that at which the fault occurs.

Reset a fault by tapping any switch on the KAT500.

Signal Audible at 28004.5 MHz:

In some installations, a signal slightly above 28 MHz may be heard from an oscillator in the KAT500. If this is an issue, you can turn off the KAT500 oscillator when it is not needed by using the *Idle Sleep* setting in the *Utility* program.

Updating Firmware

Although the KAT500 is shipped with current firmware installed, from time to time updates and improved firmware may become available.

To update firmware you will need:

The KAT500 Utility Program available free from Elecraft at <https://elecraft.com>

Updated firmware may be obtained in several ways.

1. Click on Firmware tab and then the Click on Copy Firmware Files from Elecraft to download the latest production released firmware or,
2. Download the new file from the Elecraft website and place it in a local folder, then click on **Browse...** to locate the folder on your computer. This is the best way to access the latest or Beta firmware available from Elecraft.
3. For those who prefer firmware on media, go to the Elecraft website and search for "Non-Downloadable Firmware" for pricing and availability.
4. If you don't have a computer, you can send your KPA500 to Elecraft to be upgraded. See Customer Service, page 1.

To install new firmware in your KAT500, click the Send Firmware to the KAT500 button to start the transfer. Follow the on-screen instructions.

Be sure to check the notes supplied with the new firmware. They may include changes that affect the instructions in this manual.

Forcing a Firmware Load

If you accidentally load an old or incompatible firmware version and find the KAT500 unresponsive, do the following:

- Switch off the power supply or disconnect the KAT500 from its power supply for at least 30 seconds. The delay is important because the KAT500 microcontroller may continue to function with very low voltage and current draw so capacitors need time to fully discharge before continuing.
- In the *Utility* program, click Close Port.
- Press and hold the KAT500 front panel MODE switch.
- Reconnect the DC power supply.
- Continue to hold the KAT500 MODE switch until the MAN LED begins to blink (about 10 seconds).
- Release the MODE switch.
- If the Utility program is running, click Test Communications. You should see a status message indicating that the KAT500 is waiting for firmware load.
- In the *Utility* program, select Send Firmware on the Firmware tab.

Kit Assembly Procedure

Preventing Electrostatic Discharge Damage

Sensitive components in your KAT500 may be damaged by Electrostatic Discharge (ESD) in any location or climate unless you take specific steps to prevent such damage. Many components can be damaged by static discharges of only a few volts: far too little for you to notice.

ESD damage may not be apparent at first. The damaged components may not fail completely. Instead, the damage may result in below-normal performance for an extended period of time before you experience a total failure.

We strongly recommend you take the following anti-static precautions (listed in order of importance) to ensure there is no voltage difference between the components and any object that touches them:

- Leave ESD-sensitive parts in their anti-static packaging until you install them. The packaging may be a special plastic bag that allow static charges to flow harmlessly over their surface, or the component's leads may be inserted in conductive foam that keep them at the same potential. Parts which are especially ESD-sensitive are identified in the parts list and in the assembly procedures.
- Wear a conductive wrist strap with a series 1-megohm resistor that will constantly drain off any static charge that accumulates on your body. If you do not have a wrist strap, touch a ground briefly before touching any sensitive parts to discharge your body. Do this frequently while you are working. You can collect a destructive static charge on your body just sitting at the work bench.



DO NOT attach a ground directly to yourself without a current-limiting resistor as this poses a serious shock hazard. A wrist strap must include a 1-megohm resistor to limit the current flow. If you choose to touch an unpainted, metal ground to discharge yourself, do it only when you are not touching any live circuits with any part of your body.

- Use a grounded anti-static mat on your work bench.
- If you choose to use a soldering iron to work on your KAT500 for any reason, be sure your iron has an ESD-safe grounded tip tied to the same common ground used by your mat or wrist strap.

Tools Required

1. #0 and #1 size Phillips screwdrivers. Use the screwdriver that best fits the screw in each step. To avoid damaging screws and nuts, a power screwdriver is *not* recommended.
2. Needle-nose pliers.

The following tools are strongly recommended:

1. ESD wrist strap.
2. Static dissipating work pad.

Assembly Procedure

- Before starting construction, do a complete inventory, comparing the parts in your kit with the parts list in Appendix A, to familiarize yourself with all of the parts and to ensure the kit is complete. If any parts are missing contact Elecraft for a replacement (see *Customer Service and Support*, page 1).
- Taking ESD precautions remove the printed circuit board from its ESD-safe envelope and install six 2-D fasteners as shown in

Figure 10. Be careful not to disturb any of the inductors on the top side, especially the air wound coils, or the position of the resistor mounted on the bottom.

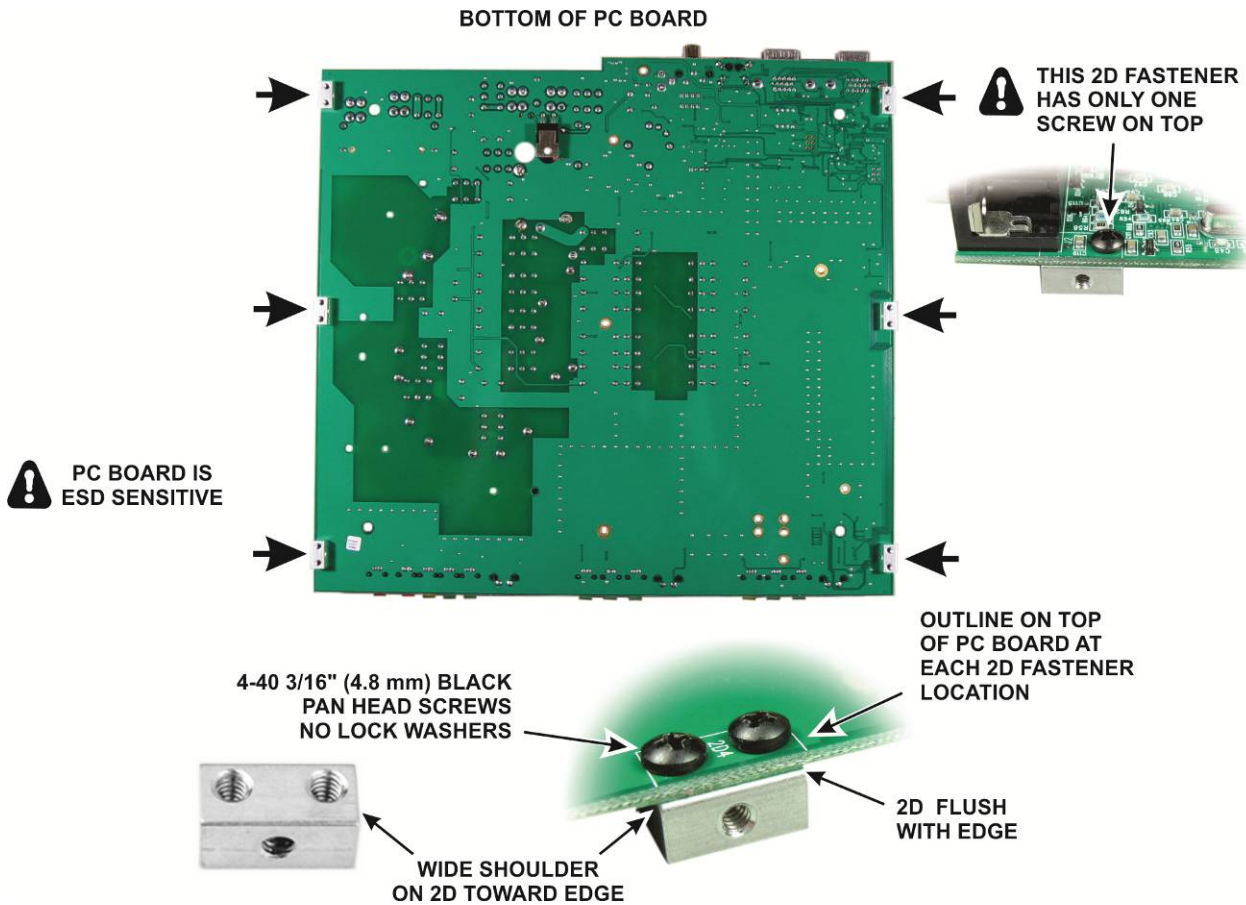

Figure 10. Installing the 2D Fasteners.

- Install a cable tie to secure each of the four large toroidal inductors to the pc board as shown below. Note how the locking heads are positioned below the pc board. If a toroid is far enough out of position to obstruct a hole in the pc board, gently reposition it as needed. Ideally each toroid will be inside the circle

silk-screened on the board. Do not over-tighten the ties. Tighten them only enough to remove any slack and provide a small amount of tension.

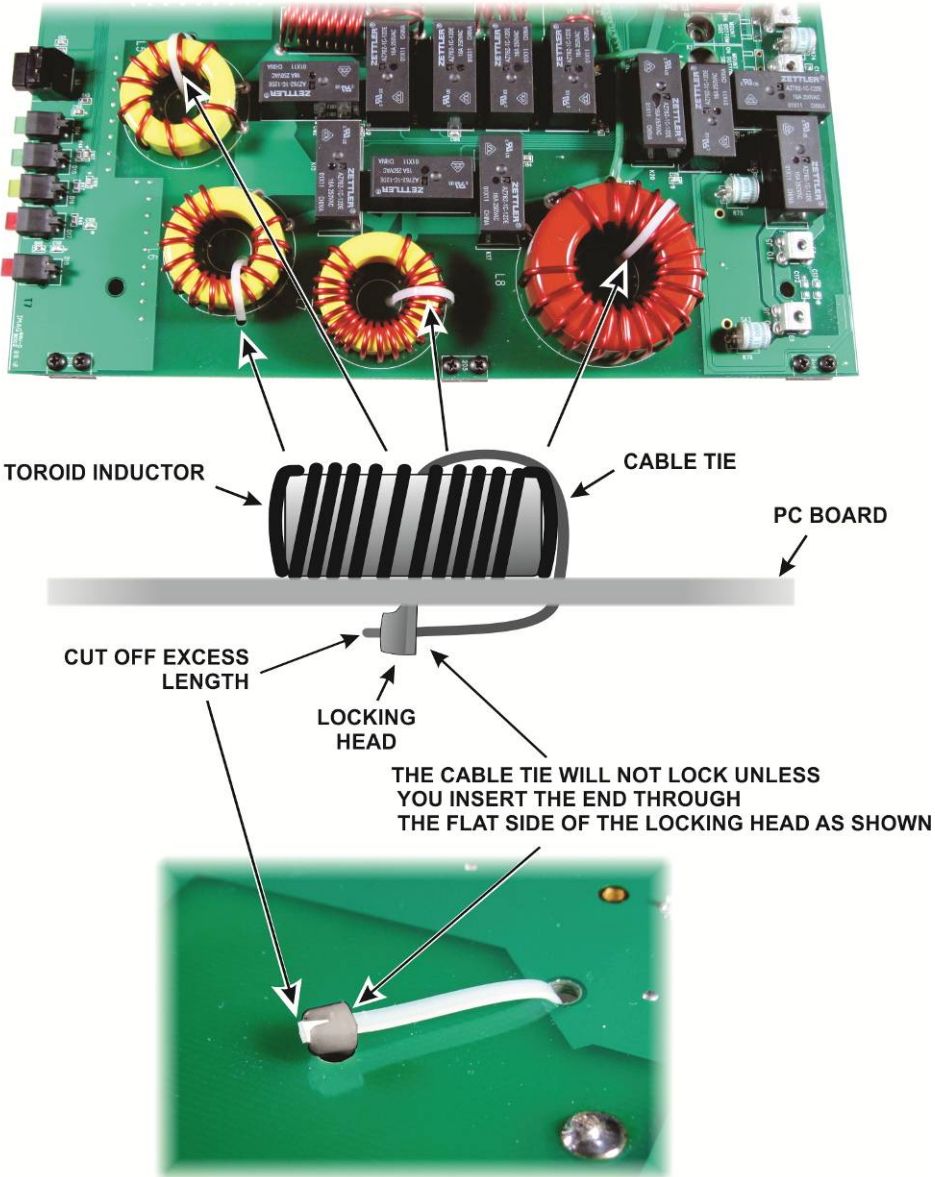

Figure 11. Installing Cable Ties on Toroids.

Install the three pairs of standoffs on the pc board shown in Figure 12. Do not use lock washers. The standoffs alone establish the right height.

⚠ Do not over-tighten or you may twist the threaded section off of the standoff.

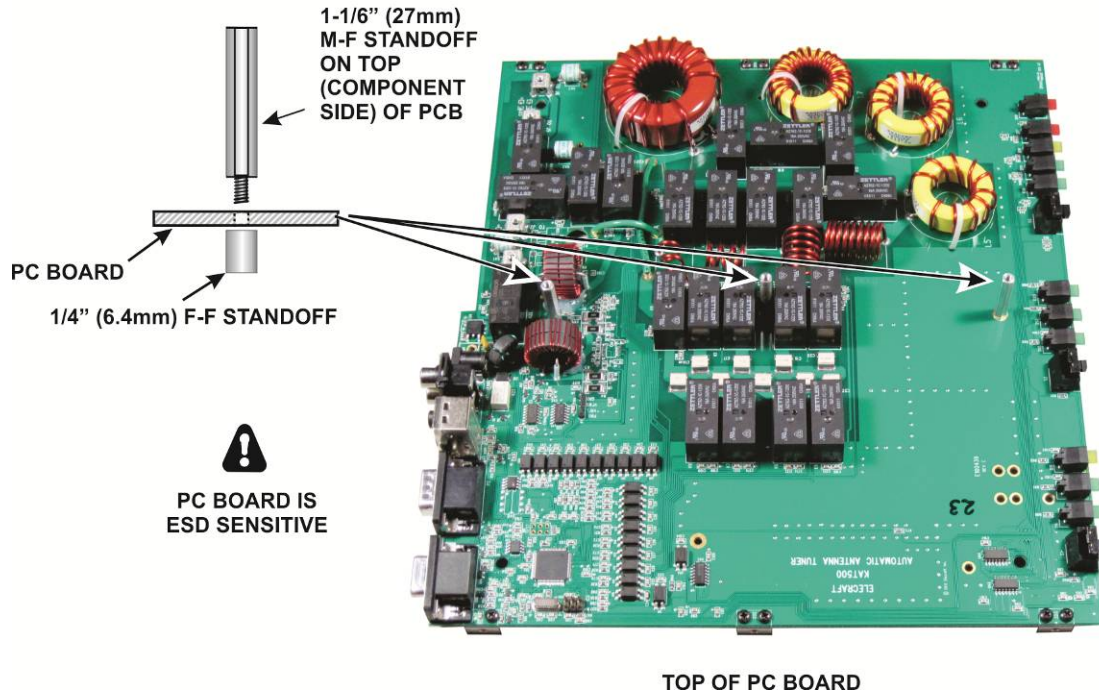

Figure 12. Install Standoffs on the PC Board.

Locate the outline marked LB1 on the pc board. It is on the connector edge of the board next to the power connector, see Figure 13.

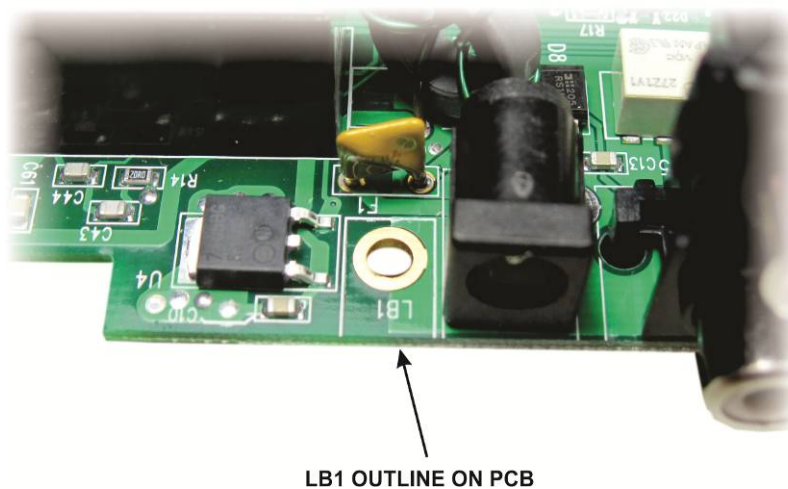

Figure 13. Angle Bracket LB1 Mounting Location.

Mount the angle bracket at LB1 on the pc board as shown in Figure 14. Note that it has a long and short side. Be sure the long side is against the pc board as shown.

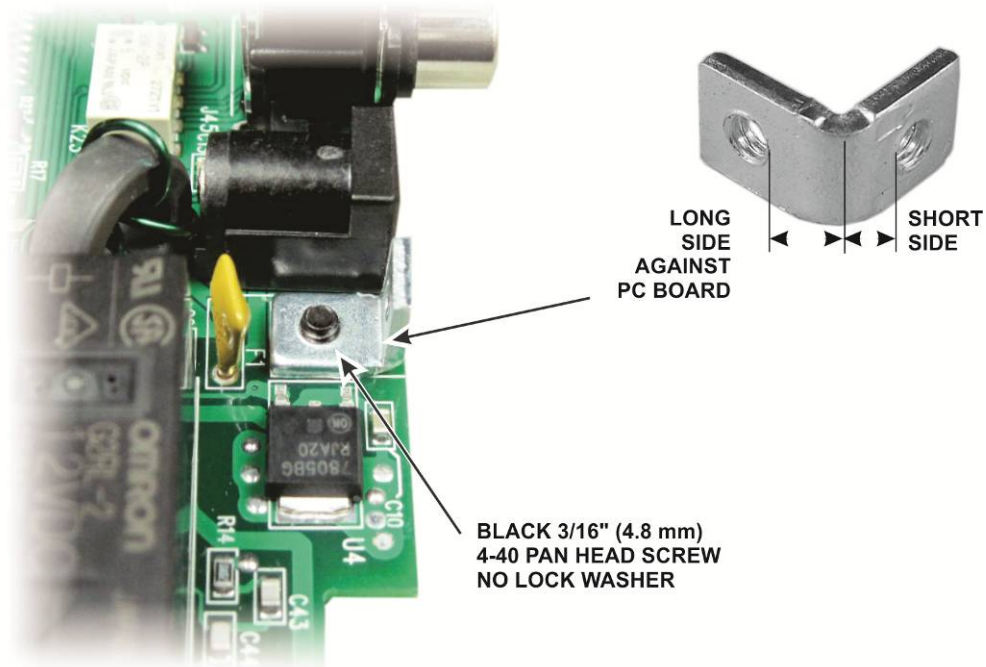

Figure 14. Installing the Angle Bracket.

Locate the bottom cover. It is the same size as the top cover, but you can identify it by the hole pattern. Check the **inside** surface and remove any tape or other residue to ensure clean, bare metal at the locations shown in Figure 15. This is important for proper grounding of the enclosure panels.

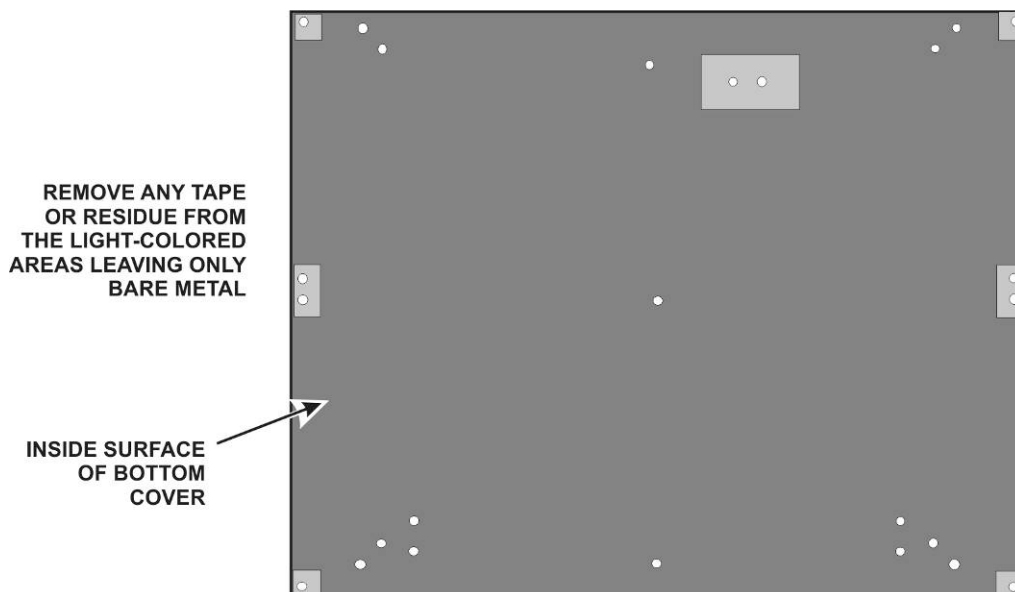

Figure 15. Preparing Bottom Cover for Installation.

☐ Turn the bottom cover over and place the four self-stick feet on the cover in the locations shown in Figure 16. Do not cover any of the holes in the bottom cover with the feet. The screw hole indicated will be used in the next step.

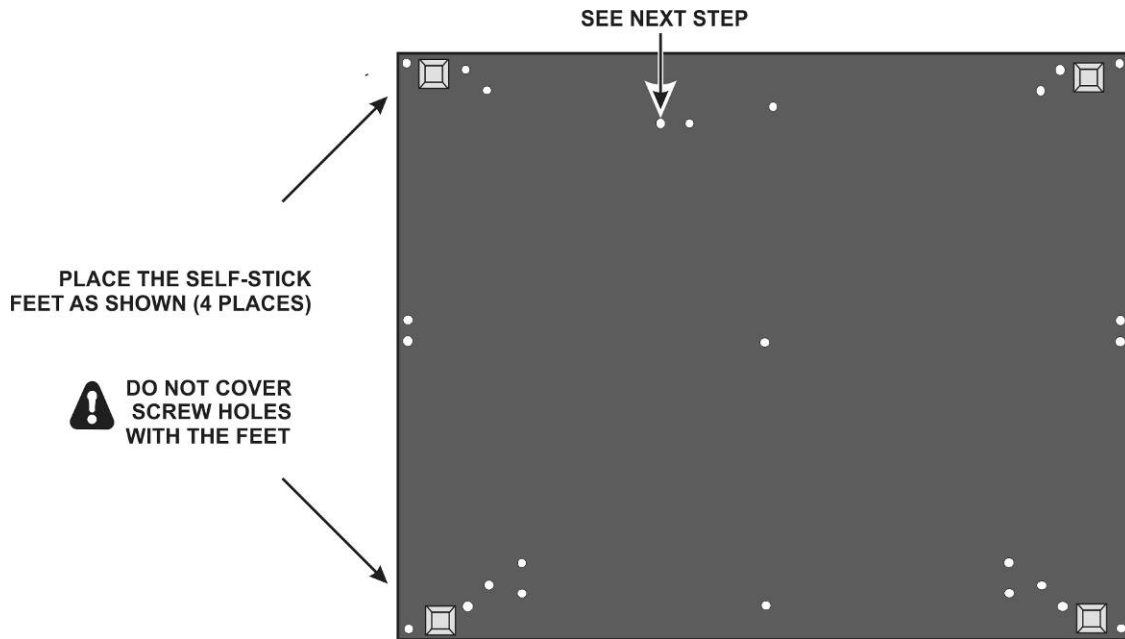

Figure 16. Placing Feet on the Bottom Cover.

☐ Install a screw, lock washer and nut in the hole indicated in Figure 16 as shown in Figure 17 with the screw head on the outside of the bottom cover. This hole is unused. The hardware is provided to fill it.

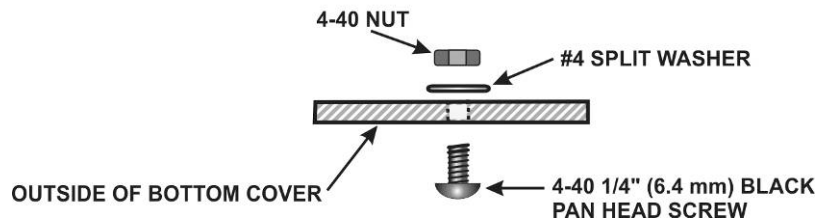

Figure 17. Installing Hardware on Bottom Cover.

- Place the circuit board component side down on your work table and attach the thermal pad to resistor R6 as shown in Figure 18.



Figure 18. Placing Thermal Pad on R6.

- Attach the bottom cover as shown in Figure 19. Note that the bottom cover only fastens to one of the two screw holes in each of the 2D fasteners mounted at the corners of the circuit board. The remaining screw holes in those 2D fasteners will be used to secure the front and rear panels. When positioning the bottom cover, be sure the open hole shown in Figure 19 lines up with the hole in the tab for R6 mounted on the circuit board.

⚠ When assembling the cabinet pieces, start each screw in the threads before tightening any screws. When adding more cabinet sections in future steps, you may need to loosen the screws for other sections so they can be adjusted slightly as needed to fit properly. Once you have done that and finished assembling your KAT500, you can remove and replace individual cabinet sections easily without further adjustments.

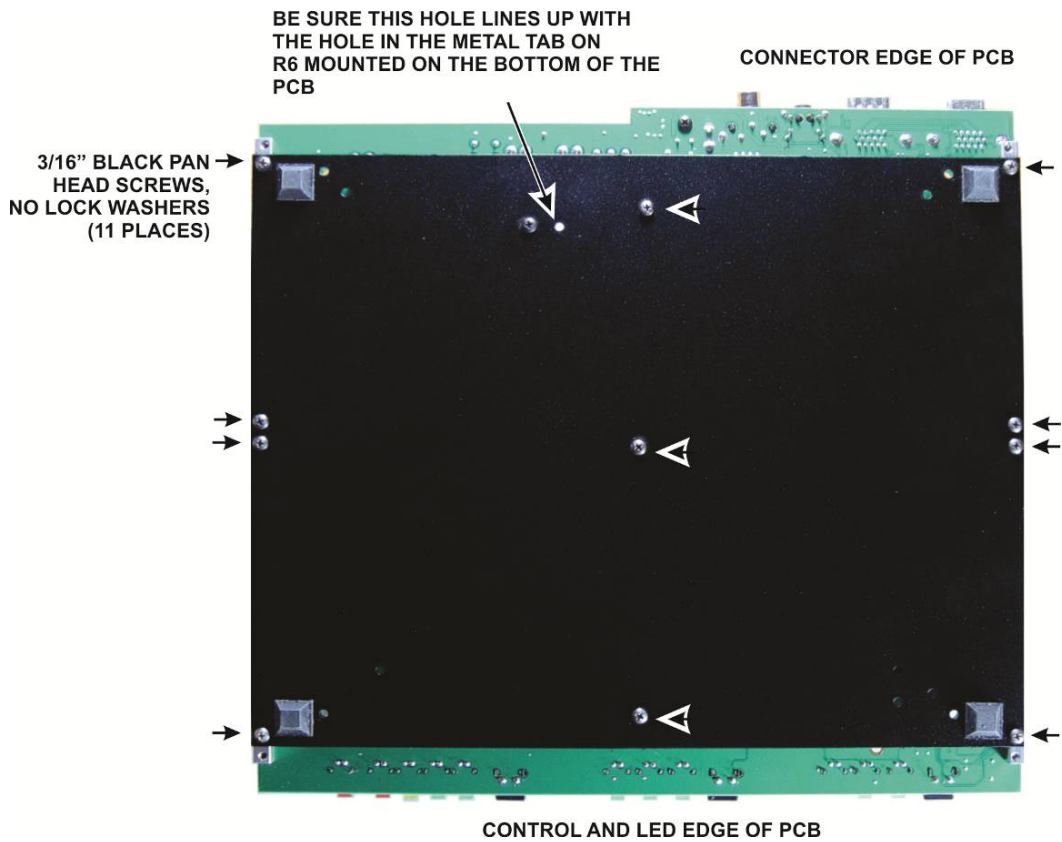

Figure 19. Installing the Bottom Cover.

- Turn the assembly over so the pc board is on top and install the R6 mounting hardware as shown in Figure 20 to secure R6 against the bottom cover.

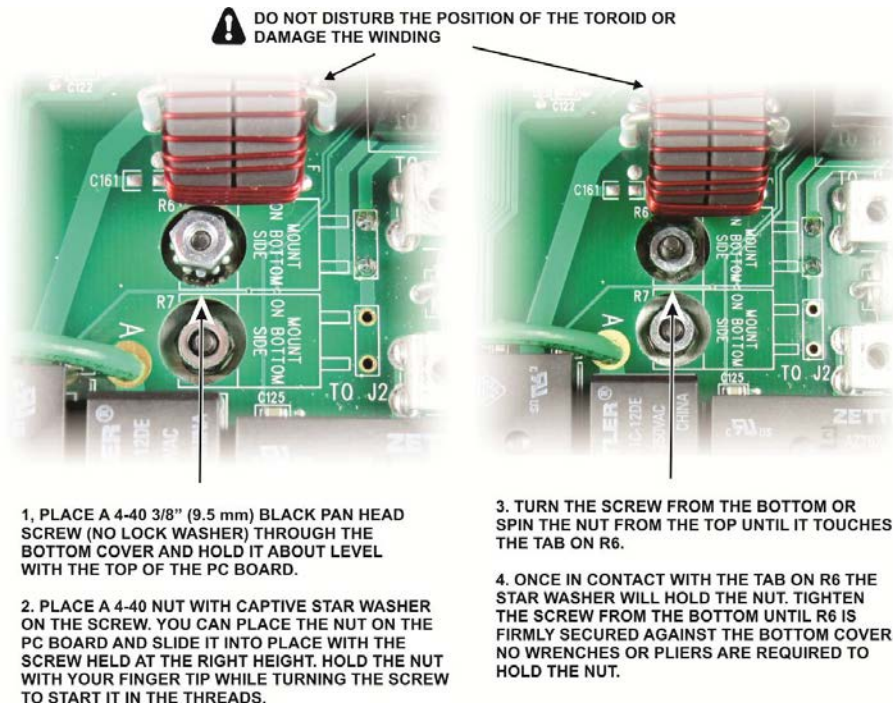

Figure 20. Install the R6 Mounting Hardware.

- Set the pc board and bottom cover assembly aside temporarily in a safe place.
- Locate the rear panel and the four SO-239 connector assemblies. **Leave the SO-239 connector assemblies in their packages until needed and do not bend or move the wire attached to each connector. The wires have been carefully pre-formed to fit in the KAT500.**
- Inspect the inside surface of the rear panel and remove any tape or residue to provide a clean metal surface where shown in Figure 21.

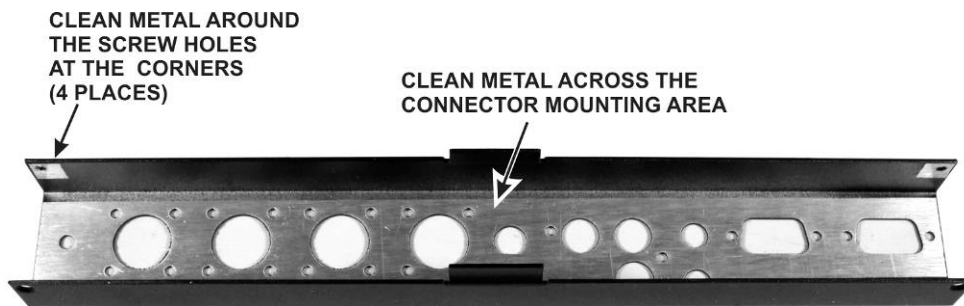

Figure 21. Preparing the Rear Panel.

- Remove the protective backing from the serial number label and press it onto the rear panel as shown in Figure 22. Be careful not to cover the screw holes or lettering on the rear panel.

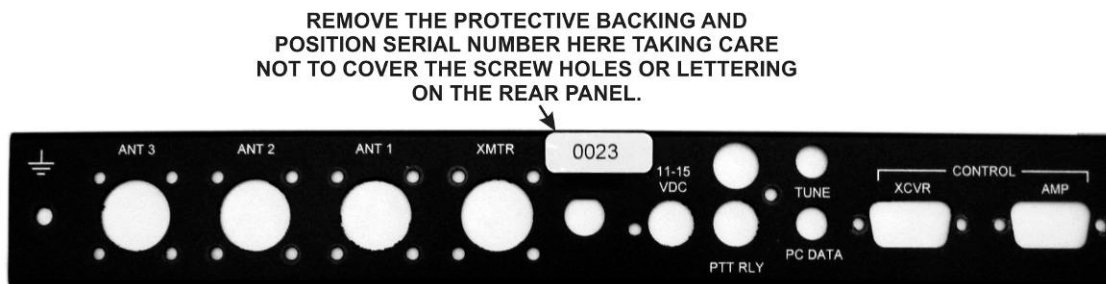

Figure 22. Attaching Serial Number to Rear Panel.

- Install the XMTR SO-239 connector in the rear panel opening marked XMTR as shown in Figure 23. Take care not to bend the wire or move the solder lug. Place the flange of the connector inside the rear

panel, and orient the connector so the lug on the wire points toward the ANT1 connector opening as shown.

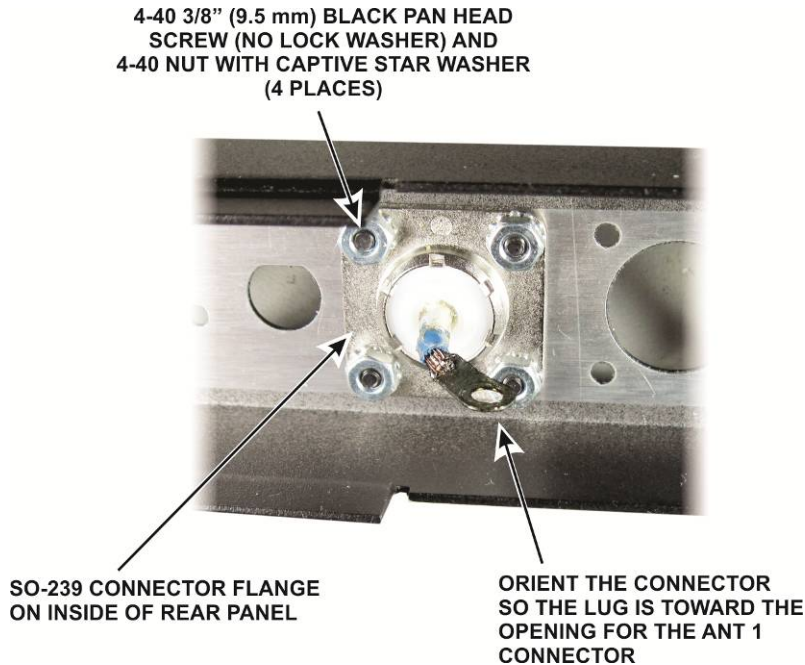

Figure 23. Installing the XMTR SO-239 Connector in the Rear Panel.

□ In the same manner, install the remaining SO-239 connectors on the rear panel, starting with the ANT3 connector at the end. Orient the connectors so the leads are as shown in Figure 24 and with the connector flanges on the inside of the rear panel.

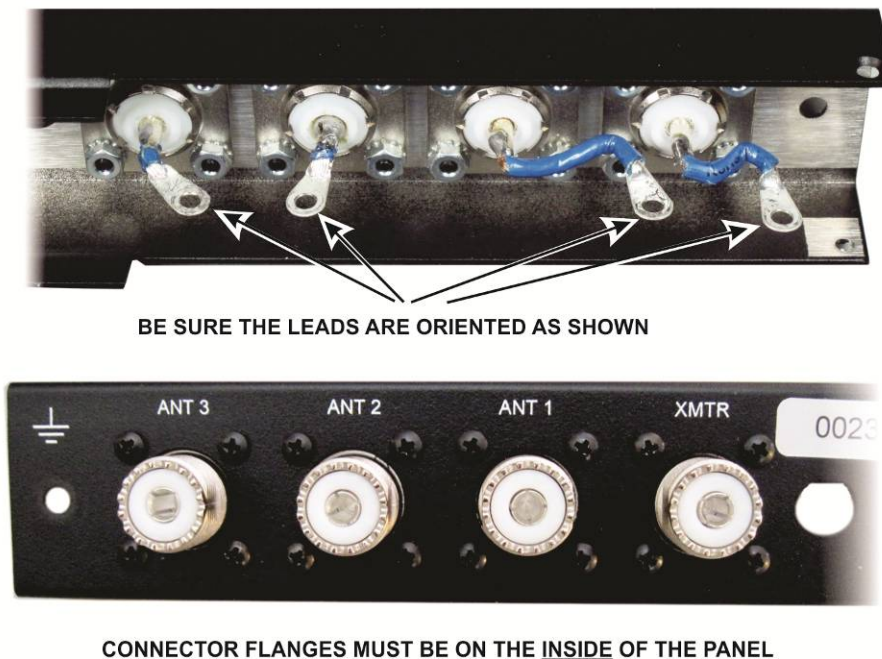

Figure 24. SO-239 Connectors Installed.

□ Mount the ground terminal at the end of the rear panel next to the ANT 3 connector as shown in Figure 25. Install the screw, lock washer and nut first and secure the nut so the screw cannot turn. Then add the two flat washers and the wing nut.

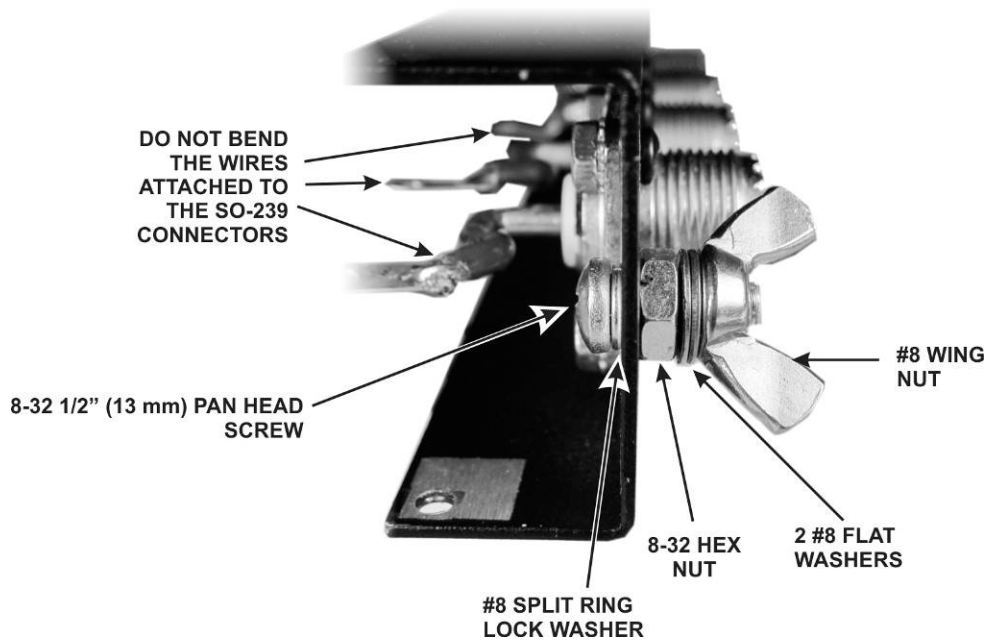
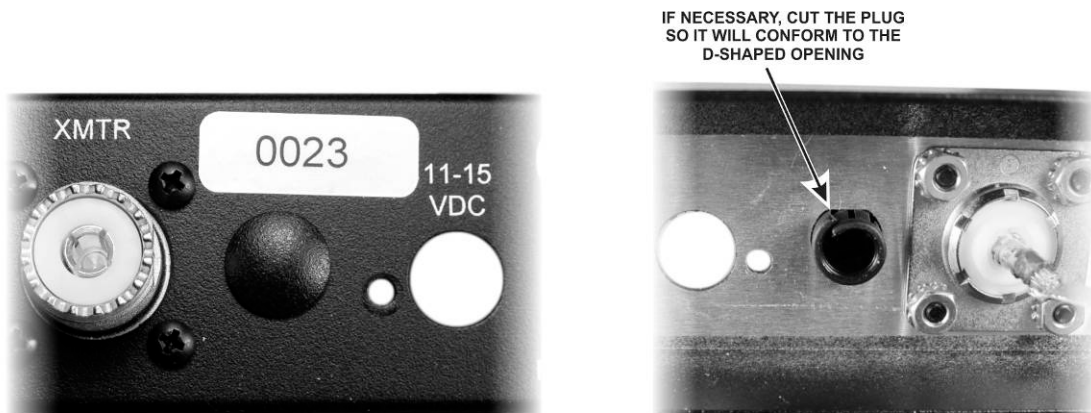

Figure 25. Installing the Ground Terminal.

If there is an opening next to the XMTR SO-239 connector as shown in Figure 26, install the BNC hole cover in the opening. Press the cover in until the ears on the plug lock it into place. This opening is “D” shaped. If needed, cut the plug section as shown to fit in the hole.



! NOT ALL UNITS HAVE THIS OPENING OR REQUIRE THE PLUG

Figure 26. Installing the BNC Hole Cover.

☐ Position the rear panel on the pc board/bottom cover assembly you assembled earlier as shown in Figure 27. Be sure the tab at the center of the rear panel fits inside the bottom cover as shown.

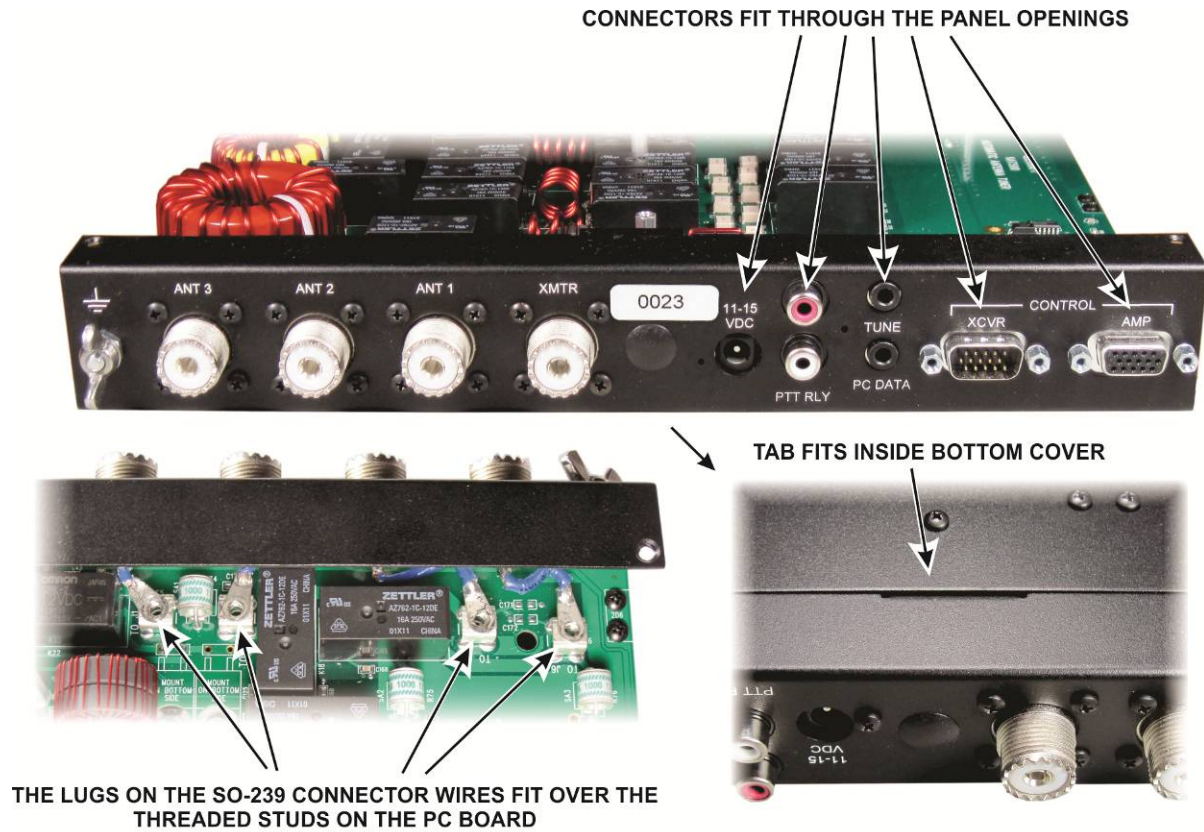

Figure 27. Positioning the Rear Cover on the PC Board and Bottom Cover Assembly.

☐ Begin securing the rear panel to the pc board assembly with four jack screw nuts on the XCVR and AMP connectors as shown in Figure 28.



⚠ CAUTION: DO NOT OVER-TIGHTEN THE NUTS. IT IS EASY TO TWIST THE NUT OFF OF THE THREADED SHAFT.

Figure 28. Installing Jackscrew Nuts on XCVR and AMP Connectors.

- Install the two pan head screws shown in Figure 29. **Stop turning the screw indicated when the head reaches the rear panel. It threads into plastic and the threads will easily strip.**

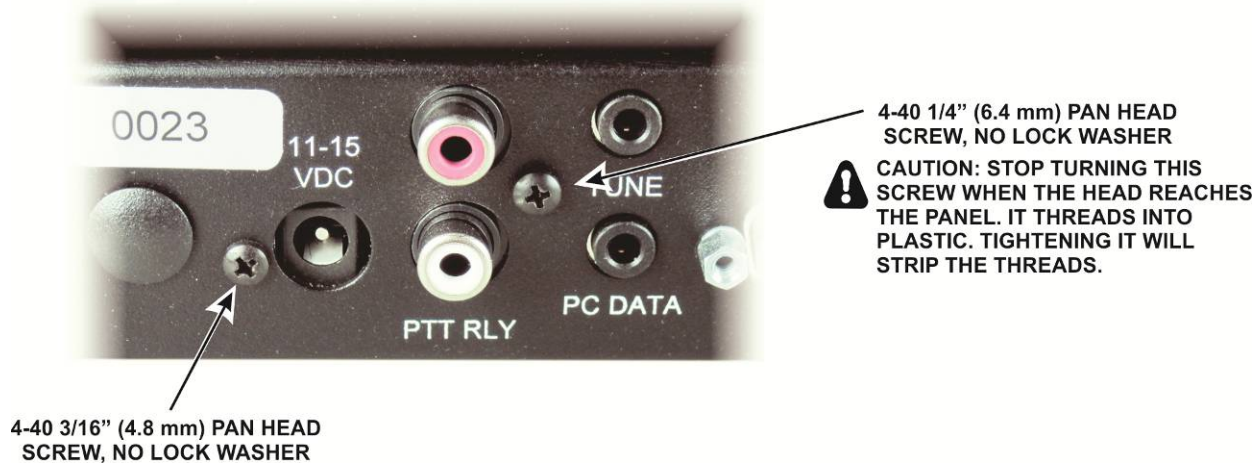

Figure 29. Installing Rear Panel Pan Head Screws.

- Attach the wires leading to each of the SO-239 connectors to the screw posts on the pc board as shown in Figure 30.

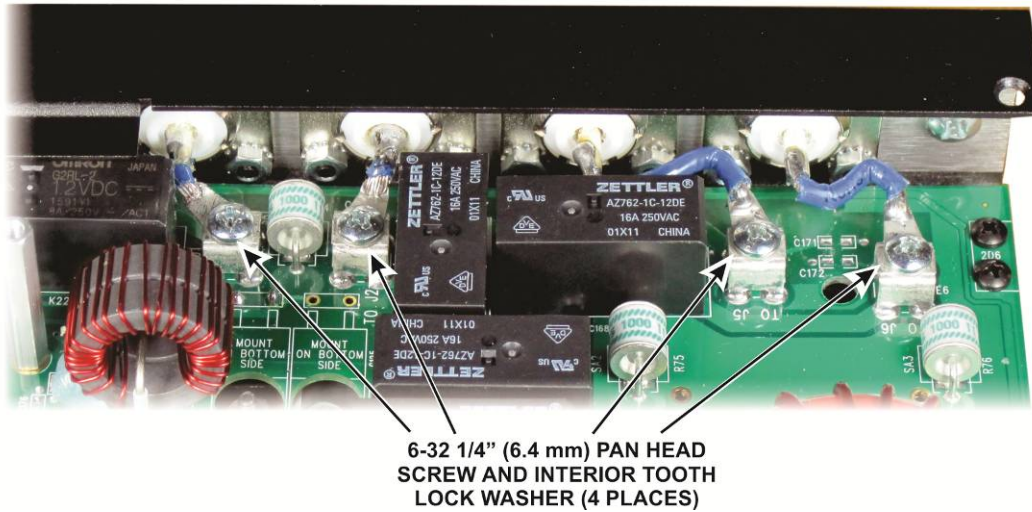

Figure 30. Securing SO-239 Wires to the PC Board Screw Posts.

Turn the assembly over and secure the bottom lip of the rear panel to the 2D fasteners as shown in Figure 31.

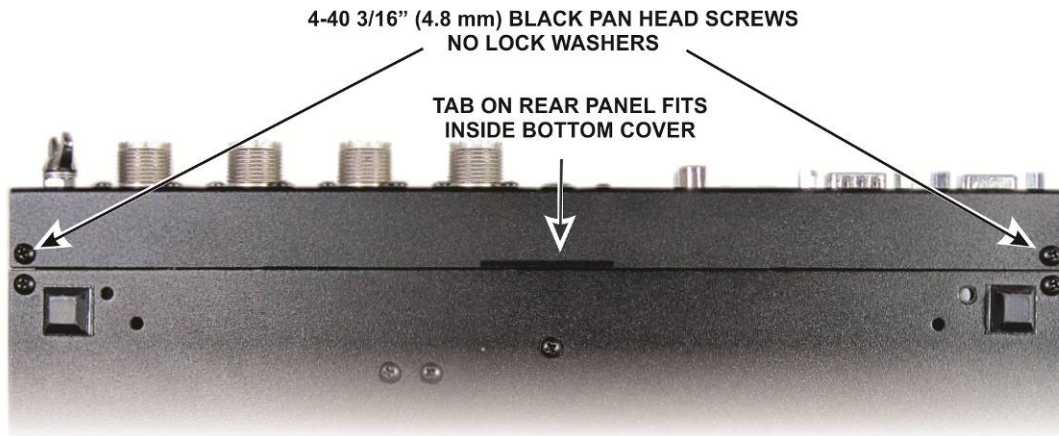

Figure 31. Installing Screws in Rear Panel Bottom Lip.

Install the four standoffs shown in Figure 32. The standoffs pass through large holes in the pc board and mount on the bottom cover as shown.

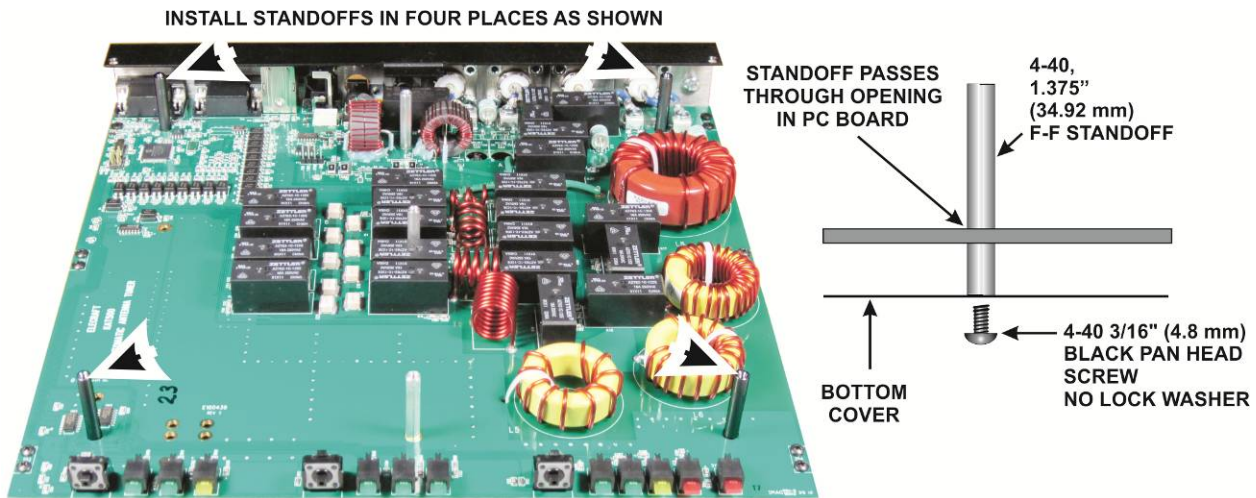

Figure 32. Installing Through-Board Standoffs.

□ On the edge of the pc board that has the rows of LEDs, install key caps on the three switches (S1, S2 and S3) as shown in Figure 33. Be sure you orient the key caps horizontally (parallel with the pc board).

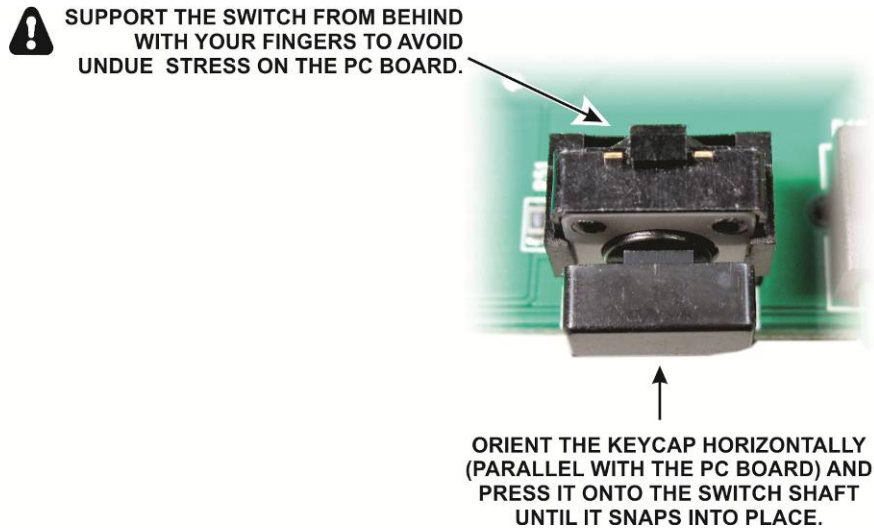

Figure 33. Installing Key Caps on the Switches.

□ Locate the front panel and inspect the inside surface around the four screw holes (see Figure 34). Remove any tape or residue to provide a clean metal surface.

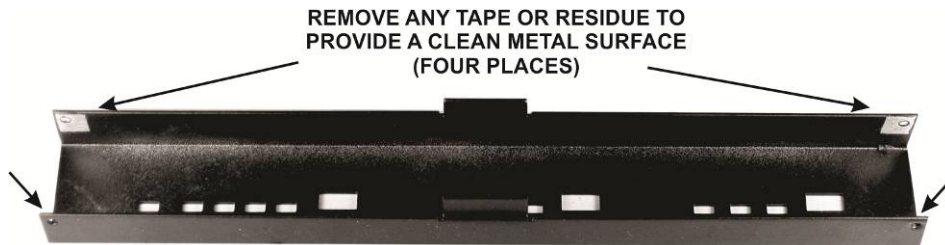

Figure 34. Preparing the Front Panel for Installation.

□ Turn the KAT500 upside down on your table and mount the front panel as shown in Figure 35. Be sure that all of the LEDs and switches pass through the openings in the front panel and that the tab at the center of the front panel fits under the bottom cover, just as on the rear panel.

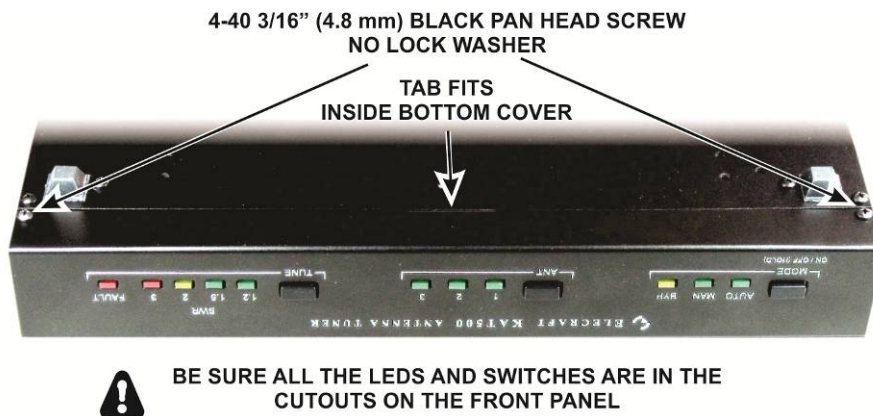

Figure 35. Mounting the Front Panel.

- Set the KAT500 on its feet and confirm that all three switches operate smoothly and that all of the LEDs are in the front panel cutouts. The LEDs should protrude slightly so you can feel them by running your finger across the panel.
- Locate the side panels and clean any tape or residue from the areas around the screw holes on the inside surface as shown in Figure 36. Check and clean both side panels.

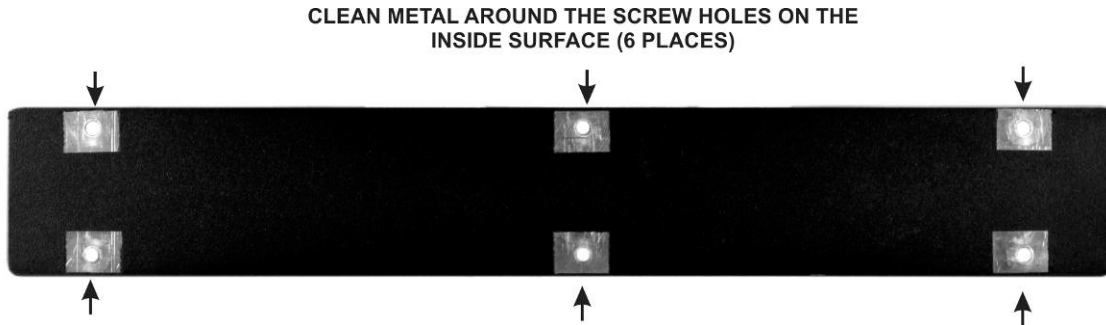

Figure 36. Preparing Side Panels for Installation.

- Place a side panel on the KAT500, lining up the three holes along the bottom with the 2D fasteners between the pc board and the bottom cover. Be sure all three holes line up. If they do not line up, turn the side panel over to line up the other three holes. Attach the side panel with three screws as shown in Figure 37 at (1).
- Mount three 2D fasteners along the top edge of the side pane as shown in Figure 37 at (2). Be sure the widest side is toward the side panel as shown. You may need to loosen the screws along the bottom edge to allow the panel to move to properly align the holes.

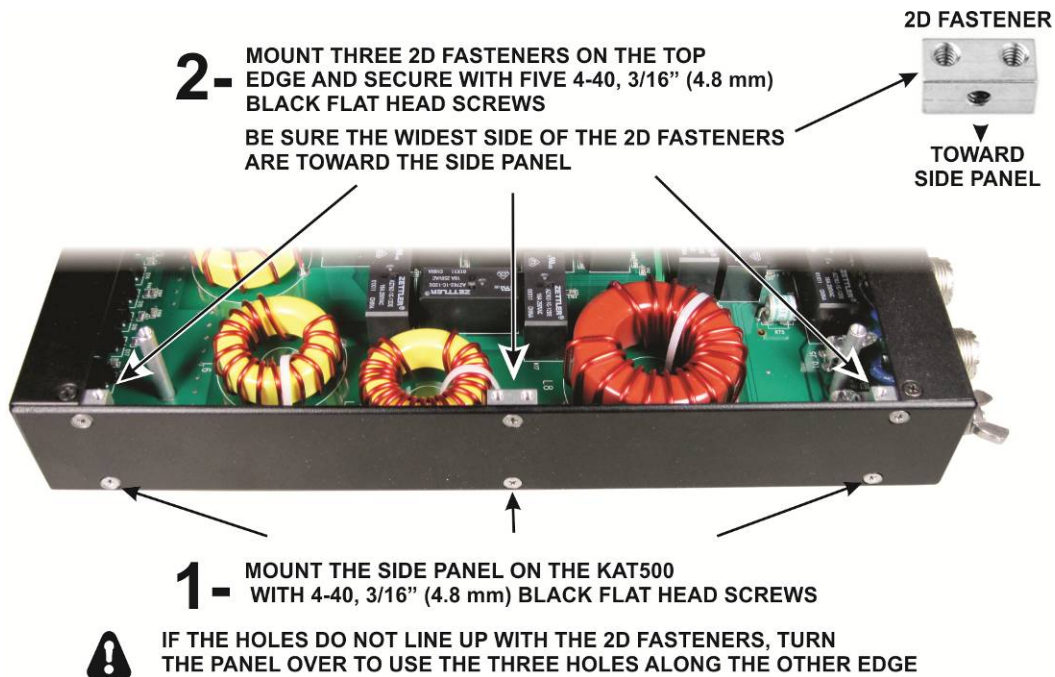

Figure 37. Installing the Side Panels.

- Install the second side panel in the same manner as the first.

In the following steps you will prepare and install the top cover. But before you do, check to ensure the screws inside the KAT500 are tight without over-tightening them:

- The 11 screws along the sides of the pc board (Figure 10, page 35).
- The four screws securing the SO-239 connector leads to the standoffs on the pc board Figure 30, page 46).

Locate the top cover and clean any tape or residue from around the holes on the inside surface along the sides as shown in Figure 38. Note that not all of the screw holes have bare metal around them. Only those shown need to be checked.

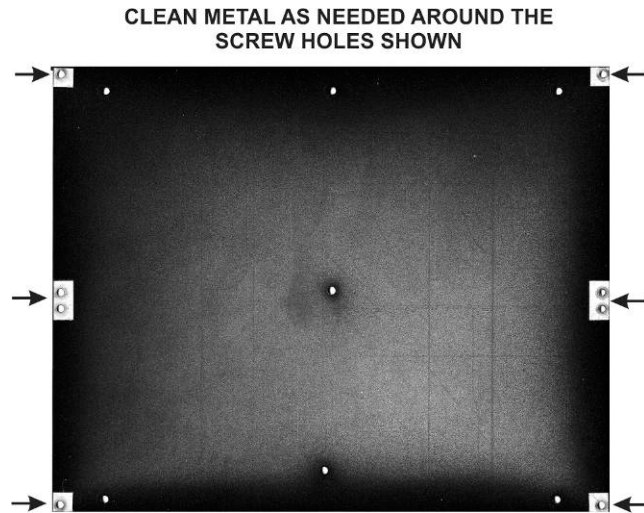

Figure 38. Preparing the Top Cover for Installation.

□ Place the top cover on the KAT500 and secure it as shown in Figure 39. The cover sits on top of the tabs at the center of the front and rear panels. If all of the screw holes do not line up, rotate it a half turn. It only fits one way. You may need to loosen some of the other enclosure screws for the cover to fit properly. That is normal. The top cover should fit flush with the surrounding panels. Once you have loosened and tightened the screws as needed for all of the panels to fit together, you will be able to remove and replace individual panels in the future, if needed, without having to repeat that process.

4-40 3/16" (4.8 mm) BLACK FLAT HEAD SCREWS WHERE INDICATED
(15 PLACES)

! LOOSEN SURROUNDING PANEL SCREWS AS NEEDED TO ADJUST THE POSITION OF THE ADJACENT PANELS FOR A SMOOTH FIT. THE TOP COVER SHOULD BE FLUSH WITH THE SURROUNDING PANELS.



Figure 39. Installing the Top Cover.



! **IMPORTANT:** The enclosure screws, including all of the top cover screws, are important to the structural strength KAT500. Always be sure that all the screws are in place and tight.

That completes the assembly of your KAT500. Turn to page 3 for setup and operating instructions.

Appendix A: Parts List

KAT500 Cable Set

The following cables are supplied with both factory-built and kit KAT500s.

ILLUSTRATION	DESCRIPTION	QTY.	ELECRAFT PART NO.
	Data Cable Assembly: Either RS232 or USB, chosen at the time order is placed. NOTE: If you chose the KXSER cable, the bag may be marked E850369.	1	KXUSB (USB) Or KXSER (RS232)
	Power Cable This cable will be found in the Core Assembly package in kits.	1	E850775
	RCA Male-to- Male (Key Line) Cable This cable will be found in the Core Assembly package in kits.	1	E100416

KAT500 Circuit Board

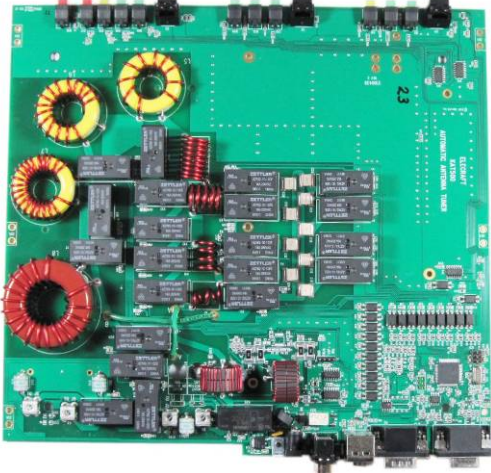
ILLUSTRATION	DESCRIPTION	QTY.	ELECRAFT PART NO.
	KAT500 PCB Assembly ⚠ ESD Sensitive. Do not remove from its ESD-Safe packaging without first taking ESD precautions (see page 34).	1	E850551

Serial Number Envelope E850549

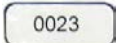

ILLUSTRATION	DESCRIPTION	QTY.	ELECRAFT PART NO.
	Serial Number Label	1	E980236

KAT500 Core Assembly – E850561

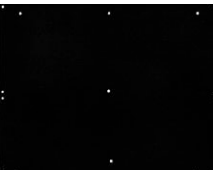
Wrapped Covers E850565





ILLUSTRATION	DESCRIPTION	QTY.	ELECRAFT PART NO.
	Bottom Cover	1	E100437
	Top Cover	1	E100438

Wrapped Panels E850564

ILLUSTRATION	DESCRIPTION	QTY.	ELECRAFT PART NO.
	Front Panel	1	E100434SS
	Rear Panel	1	E100435SS
	Side Panel	2	E100436

Miscellaneous Bag E850562



ILLUSTRATION	DESCRIPTION	QTY.	ELECRAFT PART NO.
	Lock Washer, #6, Interior Tooth	4	E700095
	4-40 Nut, Hex, Zinc	1	E700011
	8-32 Nut, Hex, Zinc	1	E700202
	4-40 Nut with Captive Star Washer	1	E700191
	Wing Nut, 8-32, Stainless Steel	1	E700193
	2-D Fastener	12	E100078
	L-Bracket	1	E700073
 (Typical)	4-40 Screw, 3/8" (9.5 mm) Black Pan Head	1	E700175
	4-40 Screw, 1/4" (6.4 mm) Black Pan Head	2	E700174
	4-40 Screw, 3/16" (4.8 mm) Black Pan Head	32	E700172
	4-40 Screw, 3/16" (4.8 mm) Black Flat Head	31	E700173
 (Typical)	8-32 Screw, 1/2" (13 mm) Zinc Pan Head	1	E700192
	6-32 Screw, 1/4" (6.4 mm) Zinc Pan Head	4	E700281
	Lock Washer, #8 Split Ring	1	E700203
	Lock Washer, #4, Split Ring	5	E700004
	BNC Hole Cover Not supplied with all units. See Figure 23 on page 33.	1	E980136
	Washer, #8 Flat	2	E700194
	1/2 X 1/2 (13 mm X 13 mm), Rubber Foot, Self-Adhesive	4	E700024
	Jackscrew Nut, 4-40	4	E700078

ILLUSTRATION	DESCRIPTION	QTY.	ELECRAFT PART NO.
	Keycap, Rectangular	3	E980000
	Thermal Pad	1	E700002
 (Typical)	4-40 F-F Standoff, 1.375" (34.92 mm)	4	E700275
	4-40 F-F Standoff, 1/4" (6.4 mm)	3	E700026
	4-40 M-F Standoff, 1-1/16" (27 mm)	3	E700276
	Cable Tie, Plastic, 4" (10.2 cm)	4	E980245



⚠ IMPORTANT: The following SO-239 Assemblies have wires pre-formed to fit in your KAT500. Each connector is different.

- Do not mix them up.
- Do not bend or reshape the wires.



Ant 1 SO-239 Assembly E850553

ILLUSTRATION	DESCRIPTION	QTY.	ELECRAFT PART NO.
	Ant 1 SO-239 Assembly	1	E850553
	4-40 Screw, 1/4" (6.4 mm) Black Pan Head	4	E700174
	4-40 Nut with Captive Star Washer	4	E700191



Ant 2 SO-239 Assembly E850560

ILLUSTRATION	DESCRIPTION	QTY.	ELECRAFT PART NO.
	Ant 2 SO-239 Assembly	1	E850560
	4-40 Screw, 1/4" (6.4 mm) Black Pan Head	4	E700174
	4-40 Nut with Captive Star Washer	4	E700191

Ant 3 SO-239 Assembly E850559

ILLUSTRATION	DESCRIPTION	QTY.	ELECRAFT PART NO.
	Ant 3 SO-239 Assembly	1	E850559
	4-40 Screw, 1/4" (6.4 mm) Black Pan Head	4	E700174
	4-40 Nut with Captive Star Washer	4	E700191

XMTR SO-239 Assembly E850554

ILLUSTRATION	DESCRIPTION	QTY.	ELECRAFT PART NO.
	XMTR SO-239 Assembly	1	E850554
	4-40 Screw, 1/4" (6.4 mm) Black Pan Head	4	E700174
	4-40 Nut with Captive Star Washer	4	E700191

Appendix B: KAT500 Frequency Segments

Information presented in this section applies to KAT500 capability and is subject to changes. The segment center frequencies shown are not necessarily legal for transmission. Always comply with the amateur radio rules and regulations in your area.

KAT500 Center Frequencies in MHz – Amateur Segments Only

160 Meters, 10 kHz Segments

1.805	1.815	1.825	1.835	1.845	1.855	1.865	1.875	1.885	1.895
1.905	1.915	1.925	1.935	1.945	1.955	1.965	1.975	1.985	1.995

80 Meters, 20 kHz Segments

3.510	3.530	3.550	3.570	3.590	3.610	3.630	3.650	3.670	3.690
3.710	3.730	3.750	3.770	3.790	3.810	3.830	3.850	3.870	3.890
3.910	3.930	3.950	3.970	3.990					

60 Meters, 20 kHz Segments

5.250	5.270	5.290	5.310	5.330	5.350	5.370	5.390	5.410	5.430
5.450	5.470	5.490							

40 Meters, 20 kHz Segments

7.010	7.030	7.050	7.070	7.090	7.110	7.130	7.150	7.170	7.190
7.210	7.230	7.250	7.270	7.290					

30 Meters, 20 kHz Segments

10.110	10.130								
--------	--------	--	--	--	--	--	--	--	--

20 Meters, 20 kHz Segments

14.010	14.030	14.050	14.070	14.090	14.110	14.130	14.150	14.170	14.190
14.210	14.230	14.250	14.270	14.290	14.310	14.330			

17 Meters, 20 kHz Segments

18.070	18.090	18.110	18.130	18.150					
--------	--------	--------	--------	--------	--	--	--	--	--

15 Meters, 20 kHz Segments

21.010	21.030	21.050	21.070	21.090	21.110	21.130	21.150	21.170	21.190
21.210	21.230	21.250	21.270	21.290	21.310	21.330	21.350	21.370	21.390
21.410	21.430								

12 Meters, 20 kHz Segments

24.890	24.910	24.930	24.950	24.970	24.990				
--------	--------	--------	--------	--------	--------	--	--	--	--

10 Meters, 100 kHz Segments

28.050	28.150	28.250	28.350	28.450	28.550	28.650	28.750	28.850	28.950
29.050	29.150	29.250	29.350	29.450	29.550	29.650			

6 Meters, 200 kHz Segments

50.100	50.300	50.500	50.700	50.900	51.100	51.300	51.500	51.700	51.900
52.100	52.300	52.500	52.700	52.900	53.100	53.300	53.500	53.700	53.900

KAT500 Center Frequencies in MHz – All Segments

Amateur band frequencies shown in red.

10 kHz Segments

1.505	1.515	1.525	1.535	1.545	1.555	1.565	1.575	1.585	1.595
1.605	1.615	1.625	1.635	1.645	1.655	1.665	1.675	1.685	1.695
1.705	1.715	1.725	1.735	1.745	1.755	1.765	1.775	1.785	1.795
1.805	1.815	1.825	1.835	1.845	1.855	1.865	1.875	1.885	1.895
1.905	1.915	1.925	1.935	1.945	1.955	1.965	1.975	1.985	1.995
2.005	2.015	2.025	2.035	2.045	2.055	2.065	2.075	2.085	2.095
2.105	2.115	2.125	2.135	2.145	2.155	2.165	2.175	2.185	2.195
2.205	2.215	2.225	2.235	2.245	2.255	2.265	2.275	2.285	2.295
2.305	2.315	2.325	2.335	2.345	2.355	2.365	2.375	2.385	2.395
2.405	2.415	2.425	2.435	2.445	2.455	2.465	2.475	2.485	2.495
2.505	2.515	2.525	2.535	2.545	2.555	2.565	2.575	2.585	2.595
2.605	2.615	2.625	2.635	2.645	2.655	2.665	2.675	2.685	2.695
2.705	2.715	2.725	2.735	2.745	2.755	2.765	2.775	2.785	2.795
2.805	2.815	2.825	2.835	2.845	2.855	2.865	2.875	2.885	2.895
2.905	2.915	2.925	2.935	2.945	2.955	2.965	2.975	2.985	2.995

20 kHz Segments

3.010	3.030	3.050	3.070	3.090	3.110	3.130	3.150	3.170	3.190
3.210	3.230	3.250	3.270	3.290	3.310	3.330	3.350	3.370	3.390
3.410	3.430	3.450	3.470	3.490	3.510	3.530	3.550	3.570	3.590
3.610	3.630	3.650	3.670	3.690	3.710	3.730	3.750	3.770	3.790
3.810	3.830	3.850	3.870	3.890	3.910	3.930	3.950	3.970	3.990
4.010	4.030	4.050	4.070	4.090	4.110	4.130	4.150	4.170	4.190
4.210	4.230	4.250	4.270	4.290	4.310	4.330	4.350	4.370	4.390
4.410	4.430	4.450	4.470	4.490	4.510	4.530	4.550	4.570	4.590
4.610	4.630	4.650	4.670	4.690	4.710	4.730	4.750	4.770	4.790
4.810	4.830	4.850	4.870	4.890	4.910	4.930	4.950	4.970	4.990
5.010	5.030	5.050	5.070	5.090	5.110	5.130	5.150	5.170	5.190
5.210	5.230	5.250	5.270	5.290	5.310	5.330	5.350	5.370	5.390
5.410	5.430	5.450	5.470	5.490	5.510	5.530	5.550	5.570	5.590
5.610	5.630	5.650	5.670	5.690	5.710	5.730	5.750	5.770	5.790
5.810	5.830	5.850	5.870	5.890	5.910	5.930	5.950	5.970	5.990
6.010	6.030	6.050	6.070	6.090	6.110	6.130	6.150	6.170	6.190
6.210	6.230	6.250	6.270	6.290	6.310	6.330	6.350	6.370	6.390
6.410	6.430	6.450	6.470	6.490	6.510	6.530	6.550	6.570	6.590
6.610	6.630	6.650	6.670	6.690	6.710	6.730	6.750	6.770	6.790
6.810	6.830	6.850	6.870	6.890	6.910	6.930	6.950	6.970	6.990
7.010	7.030	7.050	7.070	7.090	7.110	7.130	7.150	7.170	7.190

20 kHz Segments - Continued

7.210	7.230	7.250	7.270	7.290	7.310	7.330	7.350	7.370	7.390
7.410	7.430	7.450	7.470	7.490	7.510	7.530	7.550	7.570	7.590
7.610	7.630	7.650	7.670	7.690	7.710	7.730	7.750	7.770	7.790
7.810	7.830	7.850	7.870	7.890	7.910	7.930	7.950	7.970	7.990
8.010	8.030	8.050	8.070	8.090	8.110	8.130	8.150	8.170	8.190
8.210	8.230	8.250	8.270	8.290	8.310	8.330	8.350	8.370	8.390
8.410	8.430	8.450	8.470	8.490	8.510	8.530	8.550	8.570	8.590
8.610	8.630	8.650	8.670	8.690	8.710	8.730	8.750	8.770	8.790
8.810	8.830	8.850	8.870	8.890	8.910	8.930	8.950	8.970	8.990
9.010	9.030	9.050	9.070	9.090	9.110	9.130	9.150	9.170	9.190
9.210	9.230	9.250	9.270	9.290	9.310	9.330	9.350	9.370	9.390
9.410	9.430	9.450	9.470	9.490	9.510	9.530	9.550	9.570	9.590
9.610	9.630	9.650	9.670	9.690	9.710	9.730	9.750	9.770	9.790
9.810	9.830	9.850	9.870	9.890	9.910	9.930	9.950	9.970	9.990
10.010	10.030	10.050	10.070	10.090	10.110	10.130	10.150	10.170	10.190
10.210	10.230	10.250	10.270	10.290	10.310	10.330	10.350	10.370	10.390
10.410	10.430	10.450	10.470	10.490	10.510	10.530	10.550	10.570	10.590
10.610	10.630	10.650	10.670	10.690	10.710	10.730	10.750	10.770	10.790
10.810	10.830	10.850	10.870	10.890	10.910	10.930	10.950	10.970	10.990
11.010	11.030	11.050	11.070	11.090	11.110	11.130	11.150	11.170	11.190
11.210	11.230	11.250	11.270	11.290	11.310	11.330	11.350	11.370	11.390
11.410	11.430	11.450	11.470	11.490	11.510	11.530	11.550	11.570	11.590
11.610	11.630	11.650	11.670	11.690	11.710	11.730	11.750	11.770	11.790
11.810	11.830	11.850	11.870	11.890	11.910	11.930	11.950	11.970	11.990
12.010	12.030	12.050	12.070	12.090	12.110	12.130	12.150	12.170	12.190
12.210	12.230	12.250	12.270	12.290	12.310	12.330	12.350	12.370	12.390
12.410	12.430	12.450	12.470	12.490	12.510	12.530	12.550	12.570	12.590
12.610	12.630	12.650	12.670	12.690	12.710	12.730	12.750	12.770	12.790
12.810	12.830	12.850	12.870	12.890	12.910	12.930	12.950	12.970	12.990
13.010	13.030	13.050	13.070	13.090	13.110	13.130	13.150	13.170	13.190
13.210	13.230	13.250	13.270	13.290	13.310	13.330	13.350	13.370	13.390
13.410	13.430	13.450	13.470	13.490	13.510	13.530	13.550	13.570	13.590
13.610	13.630	13.650	13.670	13.690	13.710	13.730	13.750	13.770	13.790
13.810	13.830	13.850	13.870	13.890	13.910	13.930	13.950	13.970	13.990
14.010	14.030	14.050	14.070	14.090	14.110	14.130	14.150	14.170	14.190
14.210	14.230	14.250	14.270	14.290	14.310	14.330	14.350	14.370	14.390
14.410	14.430	14.450	14.470	14.490	14.510	14.530	14.550	14.570	14.590
14.610	14.630	14.650	14.670	14.690	14.710	14.730	14.750	14.770	14.790
14.810	14.830	14.850	14.870	14.890	14.910	14.930	14.950	14.970	14.990
15.010	15.030	15.050	15.070	15.090	15.110	15.130	15.150	15.170	15.190

20 kHz Segments - Continued

15.210	15.230	15.250	15.270	15.290	15.310	15.330	15.350	15.370	15.390
15.410	15.430	15.450	15.470	15.490	15.510	15.530	15.550	15.570	15.590
15.610	15.630	15.650	15.670	15.690	15.710	15.730	15.750	15.770	15.790
15.810	15.830	15.850	15.870	15.890	15.910	15.930	15.950	15.970	15.990
16.010	16.030	16.050	16.070	16.090	16.110	16.130	16.150	16.170	16.190
16.210	16.230	16.250	16.270	16.290	16.310	16.330	16.350	16.370	16.390
16.410	16.430	16.450	16.470	16.490	16.510	16.530	16.550	16.570	16.590
16.610	16.630	16.650	16.670	16.690	16.710	16.730	16.750	16.770	16.790
16.810	16.830	16.850	16.870	16.890	16.910	16.930	16.950	16.970	16.990
17.010	17.030	17.050	17.070	17.090	17.110	17.130	17.150	17.170	17.190
17.210	17.230	17.250	17.270	17.290	17.310	17.330	17.350	17.370	17.390
17.410	17.430	17.450	17.470	17.490	17.510	17.530	17.550	17.570	17.590
17.610	17.630	17.650	17.670	17.690	17.710	17.730	17.750	17.770	17.790
17.810	17.830	17.850	17.870	17.890	17.910	17.930	17.950	17.970	17.990
18.010	18.030	18.050	18.070	18.090	18.110	18.130	18.150	18.170	18.190
18.210	18.230	18.250	18.270	18.290	18.310	18.330	18.350	18.370	18.390
18.410	18.430	18.450	18.470	18.490	18.510	18.530	18.550	18.570	18.590
18.610	18.630	18.650	18.670	18.690	18.710	18.730	18.750	18.770	18.790
18.810	18.830	18.850	18.870	18.890	18.910	18.930	18.950	18.970	18.990
19.010	19.030	19.050	19.070	19.090	19.110	19.130	19.150	19.170	19.190
19.210	19.230	19.250	19.270	19.290	19.310	19.330	19.350	19.370	19.390
19.410	19.430	19.450	19.470	19.490	19.510	19.530	19.550	19.570	19.590
19.610	19.630	19.650	19.670	19.690	19.710	19.730	19.750	19.770	19.790
19.810	19.830	19.850	19.870	19.890	19.910	19.930	19.950	19.970	19.990
20.010	20.030	20.050	20.070	20.090	20.110	20.130	20.150	20.170	20.190
20.210	20.230	20.250	20.270	20.290	20.310	20.330	20.350	20.370	20.390
20.410	20.430	20.450	20.470	20.490	20.510	20.530	20.550	20.570	20.590
20.610	20.630	20.650	20.670	20.690	20.710	20.730	20.750	20.770	20.790
20.810	20.830	20.850	20.870	20.890	20.910	20.930	20.950	20.970	20.990
21.010	21.030	21.050	21.070	21.090	21.110	21.130	21.150	21.170	21.190
21.210	21.230	21.250	21.270	21.290	21.310	21.330	21.350	21.370	21.390
21.410	21.430	21.450	21.470	21.490	21.510	21.530	21.550	21.570	21.590
21.610	21.630	21.650	21.670	21.690	21.710	21.730	21.750	21.770	21.790
21.810	21.830	21.850	21.870	21.890	21.910	21.930	21.950	21.970	21.990
22.010	22.030	22.050	22.070	22.090	22.110	22.130	22.150	22.170	22.190
22.210	22.230	22.250	22.270	22.290	22.310	22.330	22.350	22.370	22.390
22.410	22.430	22.450	22.470	22.490	22.510	22.530	22.550	22.570	22.590
22.610	22.630	22.650	22.670	22.690	22.710	22.730	22.750	22.770	22.790
22.810	22.830	22.850	22.870	22.890	22.910	22.930	22.950	22.970	22.990
23.010	23.030	23.050	23.070	23.090	23.110	23.130	23.150	23.170	23.190

20 kHz Segments - Continued

23.210	23.230	23.250	23.270	23.290	23.310	23.330	23.350	23.370	23.390
23.410	23.430	23.450	23.470	23.490	23.510	23.530	23.550	23.570	23.590
23.610	23.630	23.650	23.670	23.690	23.710	23.730	23.750	23.770	23.790
23.810	23.830	23.850	23.870	23.890	23.910	23.930	23.950	23.970	23.990
24.010	24.030	24.050	24.070	24.090	24.110	24.130	24.150	24.170	24.190
24.210	24.230	24.250	24.270	24.290	24.310	24.330	24.350	24.370	24.390
24.410	24.430	24.450	24.470	24.490	24.510	24.530	24.550	24.570	24.590
24.610	24.630	24.650	24.670	24.690	24.710	24.730	24.750	24.770	24.790
24.810	24.830	24.850	24.870	24.890	24.910	24.930	24.950	24.970	24.990
25.010	25.030	25.050	25.070	25.090	25.110	25.130	25.150	25.170	25.190
25.210	25.230	25.250	25.270	25.290	25.310	25.330	25.350	25.370	25.390
25.410	25.430	25.450	25.470	25.490	25.510	25.530	25.550	25.570	25.590
25.610	25.630	25.650	25.670	25.690	25.710	25.730	25.750	25.770	25.790
25.810	25.830	25.850	25.870	25.890	25.910	25.930	25.950	25.970	25.990

100 kHz Segments

26.050	26.150	26.250	26.350	26.450	26.550	26.650	26.750	26.850	26.950
27.050	27.150	27.250	27.350	27.450	27.550	27.650	27.750	27.850	27.950
28.050	28.150	28.250	28.350	28.450	28.550	28.650	28.750	28.850	28.950
29.050	29.150	29.250	29.350	29.450	29.550	29.650	29.750	29.850	29.950
30.050	30.150	30.250	30.350	30.450	30.550	30.650	30.750	30.850	30.950
31.050	31.150	31.250	31.350	31.450	31.550	31.650	31.750	31.850	31.950
32.050	32.150	32.250	32.350	32.450	32.550	32.650	32.750	32.850	32.950
33.050	33.150	33.250	33.350	33.450	33.550	33.650	33.750	33.850	33.950
34.050	34.150	34.250	34.350	34.450	34.550	34.650	34.750	34.850	34.950
35.050	35.150	35.250	35.350	35.450	35.550	35.650	35.750	35.850	35.950
36.050	36.150	36.250	36.350	36.450	36.550	36.650	36.750	36.850	36.950
37.050	37.150	37.250	37.350	37.450	37.550	37.650	37.750	37.850	37.950

200 kHz Segments

38.100	38.300	38.500	38.700	38.900	39.100	39.300	39.500	39.700	39.900
40.100	40.300	40.500	40.700	40.900	41.100	41.300	41.500	41.700	41.900
42.100	42.300	42.500	42.700	42.900	43.100	43.300	43.500	43.700	43.900
44.100	44.300	44.500	44.700	44.900	45.100	45.300	45.500	45.700	45.900
46.100	46.300	46.500	46.700	46.900	47.100	47.300	47.500	47.700	47.900
48.100	48.300	48.500	48.700	48.900	49.100	49.300	49.500	49.700	49.900
50.100	50.300	50.500	50.700	50.900	51.100	51.300	51.500	51.700	51.900
52.100	52.300	52.500	52.700	52.900	53.100	53.300	53.500	53.700	53.900
54.100	54.300	54.500	54.700	54.900	55.100	55.300	55.500	55.700	55.900
56.100	56.300	56.500	56.700	56.900	57.100	57.300	57.500	57.700	57.900
58.100	58.300	58.500	58.700	58.900	59.100	59.300	59.500	59.700	59.900