



ANTENNA TUNER

Model **AT-180**

OPERATING MANUAL

We are happy you have chosen the Model AT-180 for your antenna tuning needs. The AT-180 has been designed with the quality and performance that makes Kenwood "The pacesetter in amateur radio".

FEATURES

1. Your AT-180 is an antenna tuner designed for use with the Kenwood TS-180S.
2. Your AT-180 consists of an antenna coupler, a through-line RF wattmeter, an SWR meter and an antenna switch.
3. Your AT-180 is designed to be used on the amateur bands between 1.8MHz and 30MHz.
4. The RF wattmeter has two ranges, 20W and 200W.
5. The antenna switch has four outputs. Two of these are for coaxial fed antennas, one is for a wire antenna and one is for connecting a dummy load.
6. The antenna matching circuit is effective in reducing TVI as it acts as a band-pass filter.
7. Your AT-180 is also capable of matching your transceiver with a wire antenna such as an inverted-L. Therefore it is possible to enjoy communication on the lower frequency bands.

CONTENTS

AT-180 SPECIFICATIONS	3
SECTION 1. TO PREPARE YOUR UNIT FOR USE	4
SECTION 2. CONTROLS AND WHAT THEY DO	5
SECTION 3. OPERATION	7
SECTION 4. CIRCUIT DESCRIPTION	10
SECTION 5. ADJUSTMENT AND MAINTENANCE	10
SCHEMATIC DIAGRAM	11

AT-180 SPECIFICATIONS

1. Antenna Coupler

Frequency range: 6 amateur bands from 1.8 to 29.7 MHz.

Input impedance: 50 Ω

Output impedance: 10 to 500 Ω , unbalanced.

Through power: 200 W at max.

Insertion loss: Less than 0.5 dB in well matching state.

PROVISO: 1.8 MHz only

Output impedance: 20 to 500 Ω , unbalanced

Through power: 100 W at max.

2. Wattmeter

Type: Through-line wattmeter.

Frequency range: 1.8 to 30 MHz.

Measurable RF power: Up to 20/200 W, switched.

Kind of RF power: Forward power and reflected power switched.

Impedance: 50 Ω

Accuracy: Better than $\pm 10\%$ of full scale.

3. SWR Meter

SWR detection: Toroidal core direction coupler.

Measurable range: 1.1 to 10

Min. power required: 4 W.

4. General

Connectors, INPUT: UHF type, 50 Ω

Connectors, ANT-1: UHF type.

ANT-2: UHF type.

ANT-3: Wire antenna only.

GND: Use this stud to ground

Dimensions: 180 (7"-1/16)W x 133

(5"-1/4)H x 287 (11"-

5/16) mm

Net weight: 3.4 kg (7.5 lbs) approx.

SECTION 1. TO PREPARE YOUR UNIT FOR USE

Accessories

Carefully unpack your AT-180 Antenna Tuner and the following accessories are included verify.

- * Operating manual 1 copy
- * Extension foot 2 pieces.
- * Insulated tube 1 piece
- * Screws, (4mm diameter) 2 pieces
- * Terminal 2 pieces

Interconnection Cable

To connect your AT-180 with the TS-180S, or other transceiver, an interconnection cable is required. Referring to Figure 1 for details.

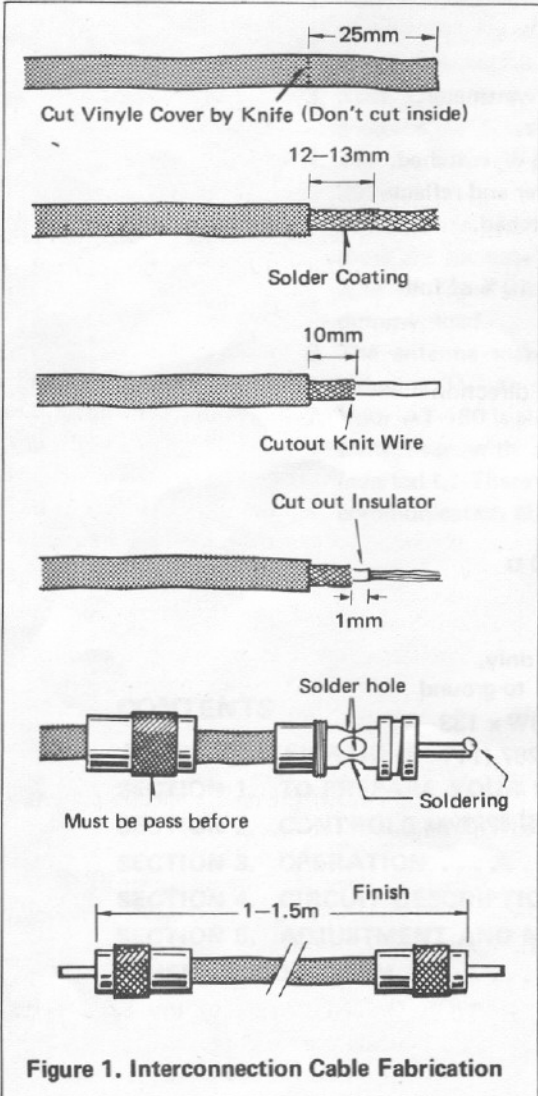

Use of Dummy Load

Using an all solid-state transceiver (such as TS-180S), you need not dummy load.

At times, you may want to use your AT-180 to check align the tube power amplifier transceiver (such as TS-820S or TS-520S).

For this purpose, a 50 Ω dummy load is necessary.

You may make one by referring to Figure 2. A 100 watt dummy load may be made with twenty 1k Ω /5W or 10W metal-film resistors in parallel.

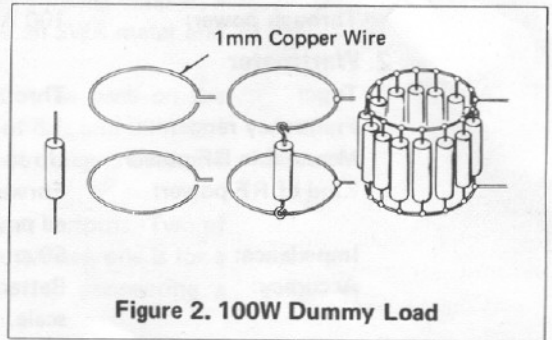

SECTION 2. CONTROLS AND WHAT THEY DO

Figure 3. Front Panel View

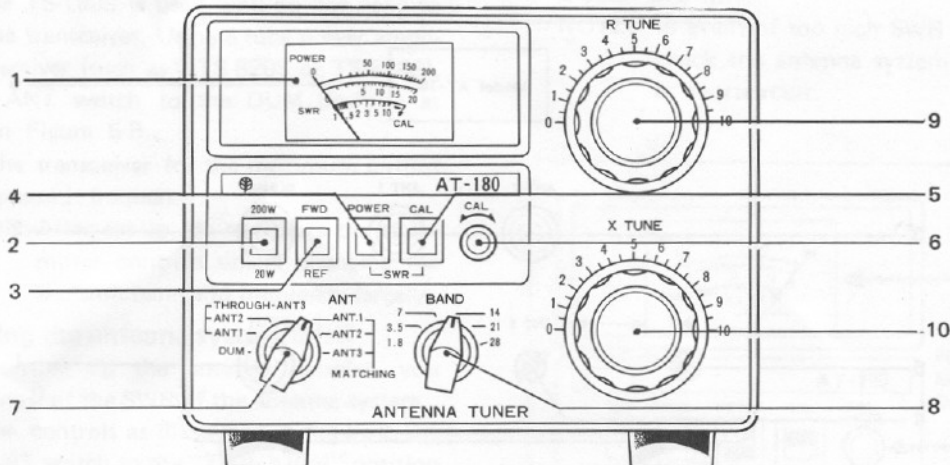

1. Meter

The meter reads SWR (standing-wave ratio) transmit power on the 200W and 20W scales that are changed with the 200W-20W switch.

2. Wattmeter Range Selector Switch

This switch selects the Wattmeter full scale, 20W or 200W. Set the switch to the 200W position for 100W transceivers.

3. FWD-REF (Forward-Reflected Wave Selector) Switch

Setting the FWD-REF switch allows the Wattmeter to read either forward power or reflected power. The effective radiated power can be known by subtracting the reflected power from the forward power.

4. POWER-SWR (Wattmeter-SWR-Selector) Switch

The POWER-SWR switch sets the meter to wattmeter in the POWER position and to SWR meter in the SWR position.

5. CAL (Calibrate) Switch

For measuring SWR, this CAL switch is set to the CAL position and the CAL control is adjusted until the meter pointer swings to the CAL position on the meter. By throwing the CAL switch to the SWR position, then, you may read the SWR directly.

6. CAL (Calibrate) Control

In measuring SWR, CAL control is used to calibrate the meter. The control can be adjusted in the manner described above.

7. ANT (Antenna Selector) Switch

Your AT-180 can connect three antennas and a dummy load as the loads to the transmitter. The ANT switch also has a "THROUGH" position at which a given antenna can be directly connected to the transmitter. At the THROUGH position, your AT-180 also can measure the output power and SWR.

8. BAND Switch

This BAND switch is to be set to a position of the 1.8 to 28 MHz bands according to the operating band.

9. R TUNE

The R TUNE adjusts the resistance component of the antenna.

10. X TUNE (Transmit Tuning) Control

The X TUNE adjusts the reactance component of the antenna.

CAUTION: DO NOT operate the band switch while transmitting.
Equipment damage WILL occur.

Fig. 4. Rear Panel Views.

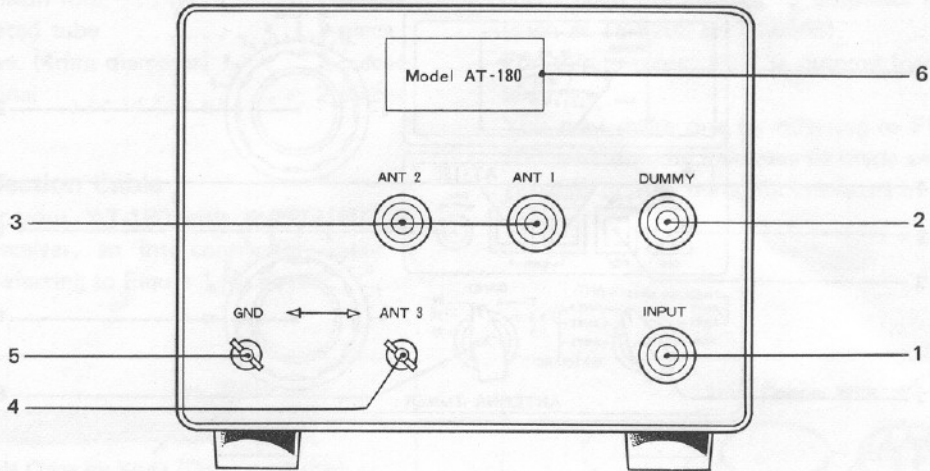

1. INPUT Connector

The INPUT UHF connector inputs the HF input signal fed from the antenna connector on the transceiver.

2. DUMMY Connector

The DUMMY connector connects a dummy load used for adjusting the transceiver. Note that the connector is not led through the antenna coupler.

3. ANT-1 and ANT-2 Connector

The ANT-1 and ANT-2 UHF-type connectors is plugged with the antenna coaxial cable.

4. ANT-3 Connector

The ANT-3 connector is plugged with a wire-type antenna, for typical example, an inverted-L antenna. Whenever connecting such an antenna, ground the GND post with wire as short as possible.

5. GND stud

The GND stud is to be grounded whenever a wire-type antenna is used.

6. Serial No. Plate

This plate is stamped with the Serial Number of your unit.

SECTION 3. OPERATION

Interconnect your AT-180 with the transceiver, antenna and dummy load as illustrated in Figure 5-A.

Adjusting the transceiver

When the TS-180S is used, you do not need to adjust the transceiver. Using a tube power amplifier transceiver (such as a TS-820S or TS-520S), set the ANT switch to the DUM position as shown in Figure 5-B.

Adjust the transceiver for the maximum output at your transmit frequency.

CAUTION: After set-up, do not move the transmitter controls unless changing the transmit band and frequency largely.

Measuring the antenna system SWR

Before setting up the antenna coupler, you should know of the SWR of the antenna system.

- Set the controls as illustrated in Figure 6. Set the ANT switch to the "THROUGH" position to which a desired antenna is connected.
- In the transmit mode, adjust CAL control so that the meter may be to the maximum swing.

- In turn, turn the CAL-SWR switch to the SWR position. Now, you will read SWR. If SWR is lower than 1.5, the antenna system is matched well for practical use: If not, you should tune it.

NOTE: In event of too high SWR (over 10), check the antenna system for break or shortcircuit.

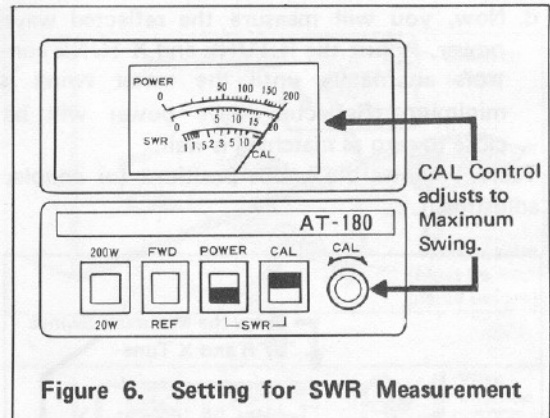

Figure 6. Setting for SWR Measurement

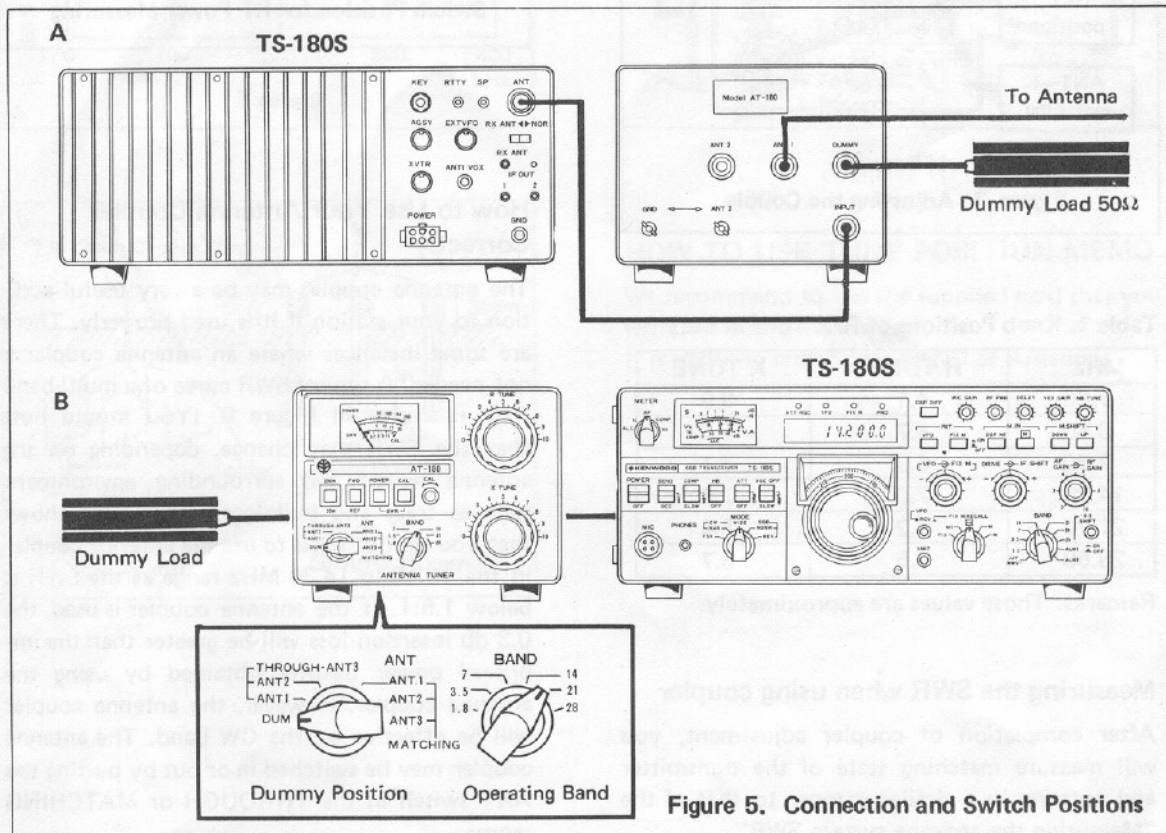

Figure 5. Connection and Switch Positions

Adjusting the antenna coupler

The antenna coupler is used to insert and match a given antenna system if its SWR is too high.

- Set the BAND switch to an operating band position as shown in Figure 7.
- Set the ANT switch to the position of the antenna to be matched.
- Turn the FWD-REF switch to the REF position.
- Now, you will measure the reflected wave power. Adjust the R TUNE and X TUNE controls alternately until the meter swing is minimum. Reflected wave power will be close to zero as matching is well.

Table 1 shows the knobs positions for coupler adjustment.

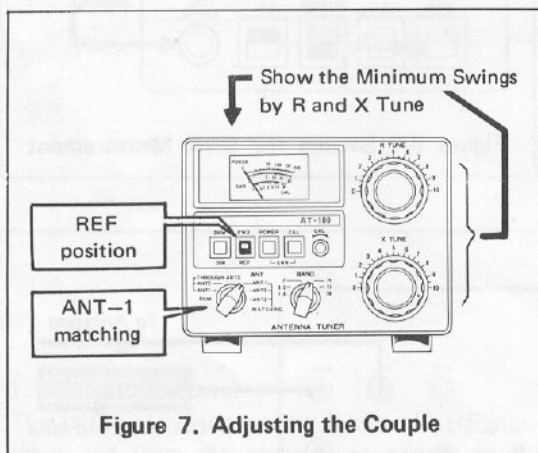

Figure 7. Adjusting the Couple

MHz	R TUNE	X TUNE
1.80	4.1	3.9
3.80	4.7	5.7
7.30	6.3	7.1
14.20	7.0	7.7
21.20	8.2	8.4
28.50	8.5	8.7

Remarks: Those values are approximately.

Measuring the SWR when using coupler

After completion of coupler adjustment, you will measure matching state of the transmitter and antenna in a similar manner to that of the "Measuring the antenna system SWR".

Measuring the Transmit Power

Set the switches as shown in Figure 8. You will measure the forward wave power with the FWD-REF switch in the FWD position. Also measure the reflected wave power with it in the REF position.

NOTE: If SWR is too high, note that the measured power is in error.

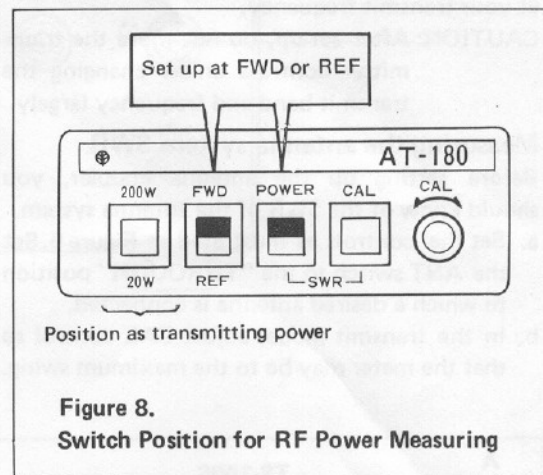

Figure 8. Switch Position for RF Power Measuring

How to Use Your Antenna Coupler Correctly

The antenna coupler may be a very useful addition to your station if it is used properly. There are some instances where an antenna coupler is not needed. A typical SWR curve of a multi-band Yagi is shown in Figure 9. (You should note that the SWR may change, depending on the antenna height and surrounding environment such as trees and buildings.) The curve shows that you do not need to use the antenna coupler in the 14.18 to 14.30 MHz range as the SWR is below 1.5:1. If the antenna coupler is used, the 0.3 db insertion loss will be greater than the improved power transfer obtained by using the antenna coupler. However, the antenna coupler will be effective on the CW band. The antenna coupler may be switched in or out by putting the ANT switch in the THROUGH or MATCHING ranges.

HOW TO USE WIRE ANTENNA CORRECTLY

Your AT-180 has a connector provided specifically for a wire antenna, so that you can enjoy communication with use of a simple antenna. Good grounding of your AT-180 is required for use with the wire antenna. For easy grounding work, use a metal ground rod specifically available on the market. For more simple work, a water faucet can be utilized. However, attention should be taken in that many recent water pipes are made of polyvinyl instead of metal.

WARNING

Never use gas pipe in any way as it is dangerous.

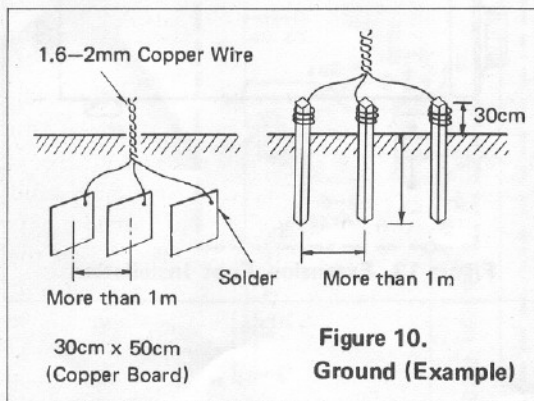
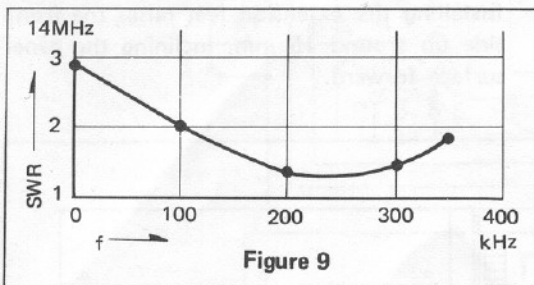

CAUTION

1. The antenna terminal ANT 3 should be insulated by a rubber tube as illustrated. It can be protected for high RF voltage.
2. GND terminals of AT-180 and transceiver should be wired by minimum length, and the earth line has been connected to AT-180 GND terminal.

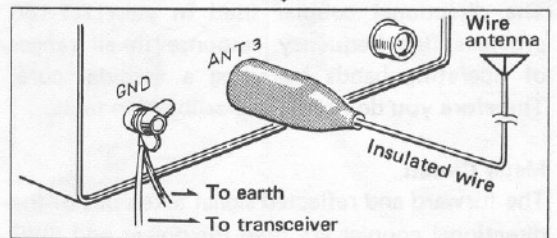
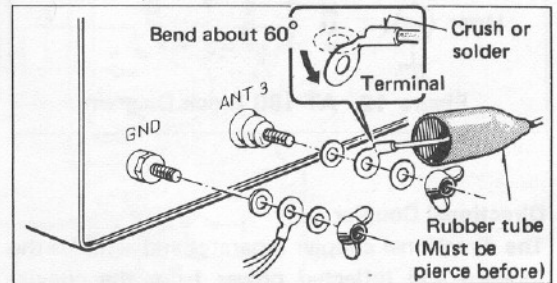

Figure 11.

HOW TO USE TUNE POSITION MEMO

We recommend to use the supplied card that you write the your antenna data.

It is useful to change the BAND or Antenna.

SECTION 4. CIRCUIT DESCRIPTION

Figure 12 is a block diagram for your AT-180.

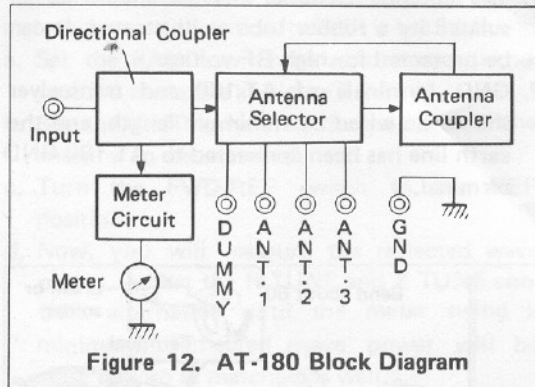

Directional Coupler

The directional coupler separates and samples the forward and reflected power from the coaxial cable connected from the transceiver to the load. The directional coupler used in your AT-180 provides flat frequency response in all ranges of operating bands by using a toroidal core. Therefore you do not need a calibration table.

Meter Circuit

The forward and reflected signal taken out of the directional coupler are used for power and SWR measurements. In the power measurement, the meter can read either forward or reflected power on the respective scales as selected with the 200-W-20W switch. In the SWR measurement, on the other hand, the forward power is calibrated with the CAL control so that the meter reads the reflected power as SWR.

Antenna Selector

The antenna selector is very useful as it can connect one of the three antennas or dummy load by a single switch, depending on a particular purpose of communication.

Antenna Coupler

The new antenna coupler is a universal matching type that is capable of matching 10Ω to 500Ω loads to the 50Ω input impedance.

The advantages are a low insertion loss realized with the use of a low-loss toroidal core and great harmonic attenuation that is effective in reducing TVI and similar radio interference.

SECTION 5. ADJUSTMENT AND MAINTENANCE

Adjustment

Your AT-180 was adjusted completely at the factory. The inside semi-fixed controls VR1 through VR3 are for precisely adjusting the meter circuit. Do not touch them. Should your AT-180 need adjustment and service, please consult your nearest KENWOOD's authorized service shop.

Maintenance

1. To remove the casing

Upper case cover: Remove the two screws holding the cover on the top and the six screw on both sides. Lift it up for removal.

Lower case cover: Do not remove the lower case cover as your AT-180 is of chassisless construction.

2. To install the extension feet (Figure 13)

Installing the extension feet raises the front side up around 15 mm, inclining the panel surface forward.

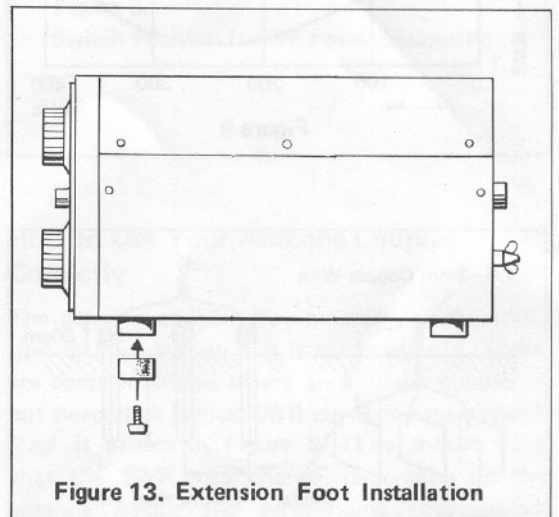

SCHEMATIC DIAGRAM

The circuit elements may be changed without notice owing to technical innovation.

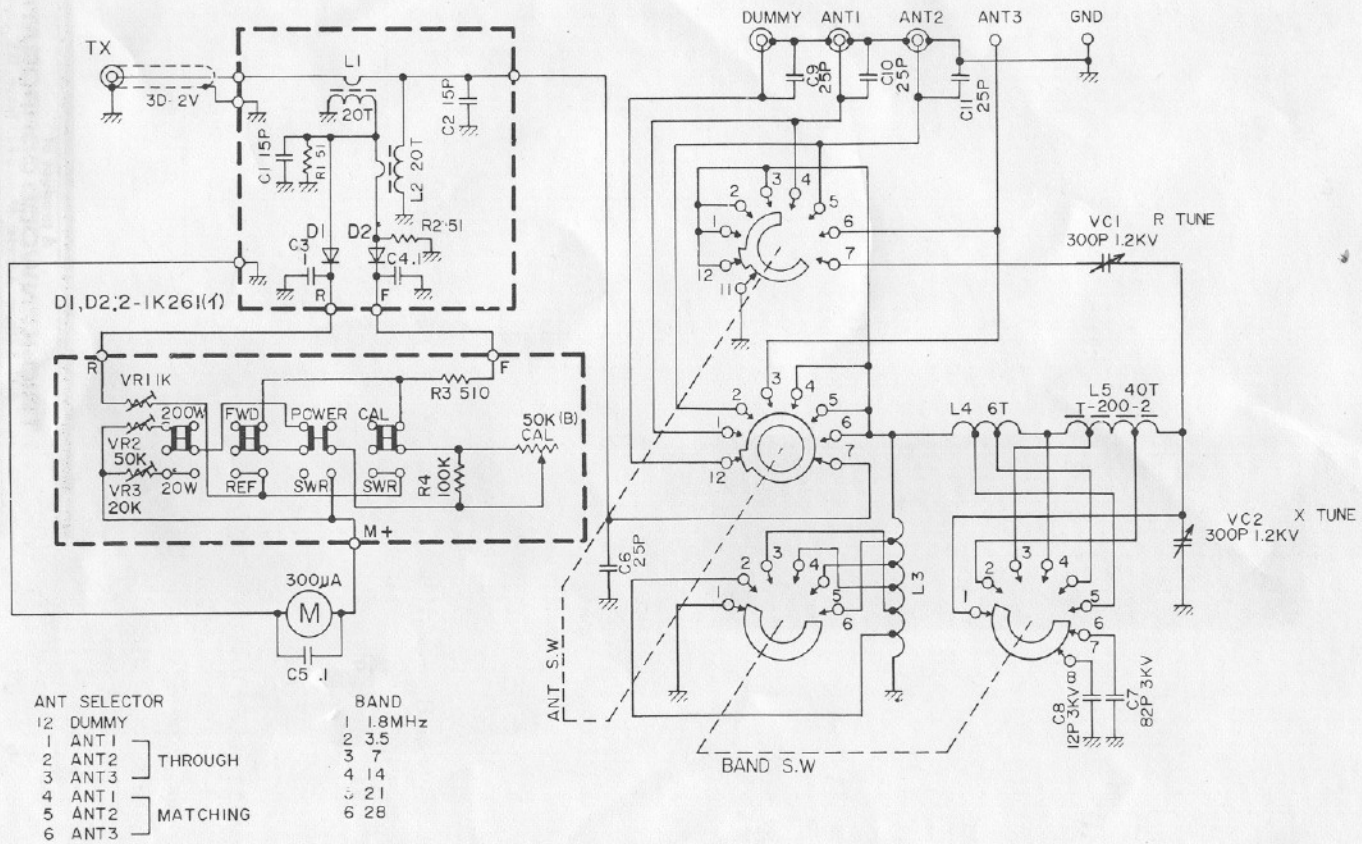

AT-180

SECTION 1.1.1 SECTION 1.1.2
CIRCUIT DESCRIPTION DIAGRAMS MAINTENANCE

The circuit diagram may be changed without notice by the manufacturer.

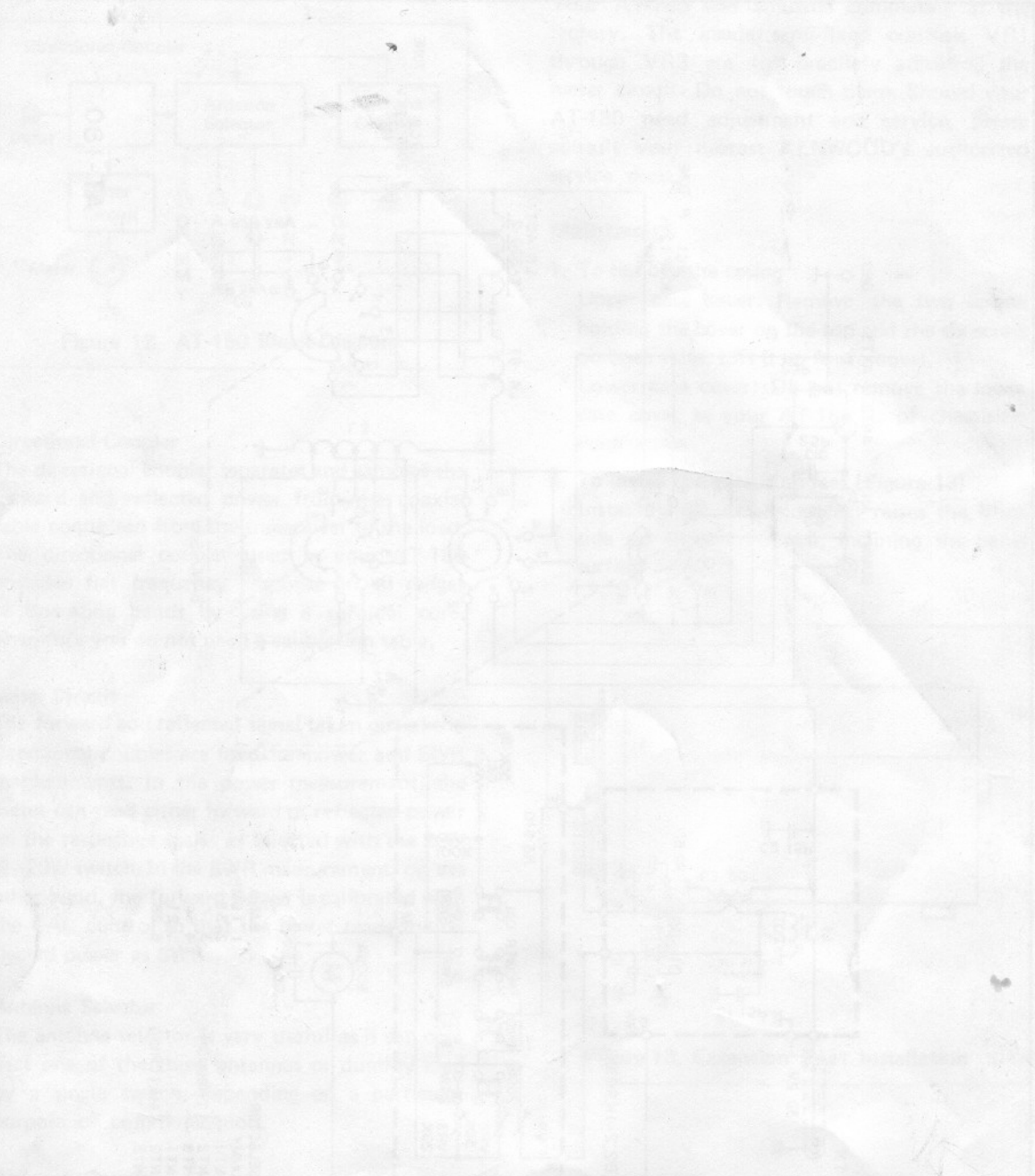

A product of
TRIO-KENWOOD CORPORATION
6-17, 3-chome, Aobadai, Meguro-ku, Tokyo 153, Japan

TRIO-KENWOOD COMMUNICATIONS, INC.
1111 West Walnut Street, Compton, California 90220, U.S.A.
TRIO-KENWOOD COMMUNICATIONS, GmbH
D-6374 Steinbach TS Industriestrasse BA, West Germany
TRIO-KENWOOD (AUSTRALIA) PTY. LTD.
30 Whiting Street, Artarmon, Sydney N.S.W. Australia 2064