

AT-250

AUTOMATIC ANTENNA TUNER



CAUTION

- 1) The AT-250 is capable of sustaining 100W continuous operating input power. However, during auto tuning, very high voltage appears in the tuning circuit and the reflected impedance for the transceiver varies greatly. Therefore, to protect the transceiver, adjust the transmit output to less than 50W before tuning.
- 2) The antenna tuner is capable of matching a 20–150 ohm load, or approximately up to 2.5:1 SWR. If the antenna and feed system exceed this range, the tuner may not stop, since it is beyond the auto tuner's capability. In this case, do not attempt further auto-tuner operation. To perform auto-tuner operation, first adjust the antenna and feed system.

You are the owner of our latest product, the new AT-250 Automatic Antenna Tuner. Please read this instruction manual carefully before placing your unit in service. The unit has been carefully engineered and manufactured to rigid quality standards, and should give you satisfactory and dependable operation for many years.

FEATURES

1. **All amateur bands covered in the HF range**
Covers all amateur bands including the new WARC band from 1.8 through 28 MHz.
2. **Automatic band selection**
When connected to the TS-430, the operating band is automatically selected from the transceiver.
3. **Dual power source capability**
Operation from either 120, 220, or 240 V AC or 13.8V DC.
4. **POWER-SWR meter**
Up to either 20 W or 200 W is indicated by the built-in POWER-SWR meter. When the METER switch is set to SWR, SWR is automatically calculated and indicated on the scale.
5. **Four antenna jacks**
Four antennas cover a broad frequency range. Any of these antennas can be selected by the ANTENNA switch on the front panel.
In normal operation (with the RX switch OUT), only the transmission signal will pass through the antenna tuner.

CONNECTIONS

■ Connection with the TS-430

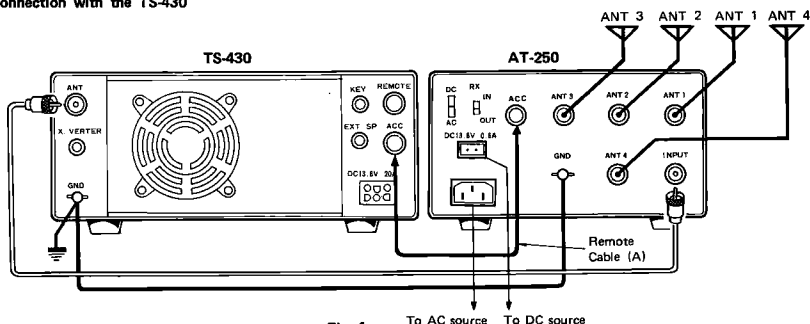

Fig. 1

1. Connect the AT-250 ACC jack to that of the TS-430 with the control cable supplied.
2. Connect the AT-250 INPUT jack with the coax. cable.
3. Connect antennas to ANT jacks (1-4) in accordance with an operation band.
4. First connect the GND terminal to that of the TS-430 and ground either terminal.
5. Connect power source AC (120 V, 220 V or 240 V selectable) or 13.8 V DC. Then set the DC/AC switch on the rear panel to AC or DC, according to the power source used.

■ Connection with a transceiver other than the TS-430

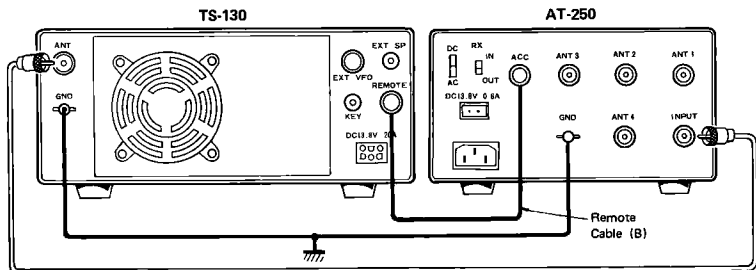

Fig. 2

Connect the AT-250 ACC jack to the transceiver REMOTE jack with the control cable supplied. (Fig. 3)

Connect the AT-250 ACC pin (3) so that the pin is grounded when transmitting.

Fig. 2 shows connection to a TS-130. The TS-530 and TS-930 can also be connected in the same way.

If used with a TS-930, remove the 7-pin wire and insert the 4-pin wire into the 7-pin connector and operate the tuner from the TS-930 control relay.

To operate with a transceiver other than a TS-430, disregard the AUTO setting of the AT-250 BAND switch.

Manually set the switch to the correct band.

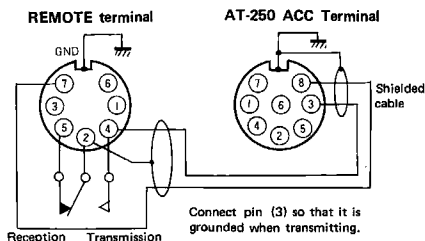

Fig. 3 View from the rear panel

■ Connection with a linear amp.

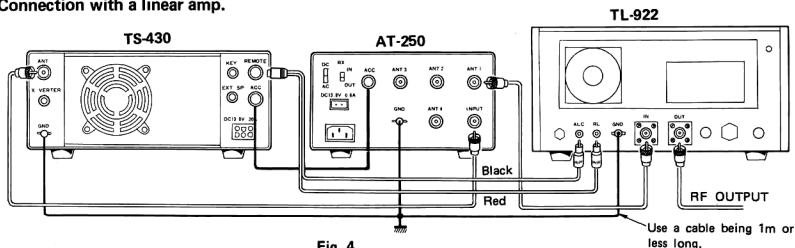
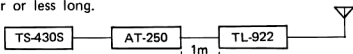

Fig. 4

When connecting the AT-250 to the KENWOOD TL-922/922A linear amplifier, use a connecting cable which is 1 meter or less long.



When operating with a transceiver other than the TS-430, use the REMOTE terminal as shown in Fig. 5. However, a linear amplifier controlled by plus voltage can be used. (Never use a linear amp controlled by minus voltage.)

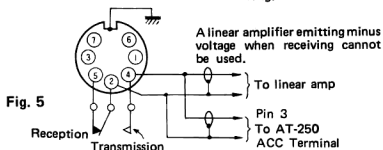

Fig. 5

Rear view of the connector

OPERATIONS

Initial set-up before operation



Fig. 6

■ Antenna SWR measurement

1. Turn the AT-250 POWER switch ON.
2. Operate the transceiver to transmit with reduced CW Power (50 W or less), in the TUNE mode.
3. Place the METER switch to SWR and the antenna SWR will be automatically calculated and displayed on the meter.

Note: To activate the SWR meter, adjust the transmitter to obtain a power output of slightly more than 3 W.

When the SWR is less than 1.5:1, further SWR adjustment is not necessary. However, if it is over 1.5:1 or when further SWR adjustment is required, operate the antenna tuner to obtain a better match, in order to operate the transmitter efficiently.

■ Auto tuning

1. Place the transceiver in the receive mode, and the TUNER and the TUNE switches to ON.
2. In the configuration, transmitting activates auto tuning and lights the TUNE indicator.
3. When the SWR reaches 1.2:1 or less, the motors stop and the TUNE indicator goes off. In this state, turn the TUNE switch OFF and reset the transceiver to the operating mode desired. The transmitter is ready for normal operation.

The antenna tuner is capable of matching a 20–150 ohm load, or approximately up to a 2.5:1 SWR. If the antenna and feed system exceed this range, the tuner may not stop, since it is beyond the auto tuner's capability. If the tuner does not stop within 20 seconds, discontinue auto-tuner operation and verify the VSWR of your system. If, after changing bands, the auto antenna tuner does not stop at match within 20 seconds, momentarily return to the receive mode, and then again operate the tuner for a match.

Note: The AT-250 is capable of sustaining 100W continuous operating input power. However, during auto tuning, very high voltage appears in the tuning circuit and the reflected impedance for the transceiver varies greatly. Therefore, to protect the transceiver, adjust the transmit output to less than 50W before tuning.

■ Antenna tuner in receive mode.

In normal operation, the AT-250 allows the transmitting signal to pass through the unit. However, setting the RX IN/OUT switch to IN allows the receiving signal to pass through the unit. With the TUNE switch ON, the receiving signal bypass the unit. With the TUNE switch OFF, the receiving signal is allowed to pass through the unit even with the RX IN/OUT switch set to IN. The status of the unit can be monitored by the TUNER indicator.

CONTROLS AND THEIR FUNCTIONS

- **POWER switch**

Turns the AT-250 power ON-OFF. Before turning the switch ON or OFF, check that the TUNER switch and the TUNE switch are set to OFF.

- **TUNER indicator**

Light ON: The signal passes through the antenna tuner.

Light OFF: The antenna tuner is through.

- **POWER-SWR meter**

Indicates transmit power and SWR. The power scale has two readings, up to 20 W and up to 200 W, selected by the METER switch.

- **TUNE indicator**

Lights when auto tuning is in operation. Goes off when auto tuning is complete and the motor stops.

- **TUNE switch**

Used to activate the auto tuning function. With the TUNER switch ON, setting this switch to ON provides an SWR of less than 1.2:1. After auto-tuning is complete and the TUNE indicator goes off, set the switch to OFF and operate the transceiver. When operating the transceiver with this switch at ON, the motor may activate during operation. With the switch to ON, the receive signal does not pass through the antenna tuner even with the RX IN-OUT switch on the rear panel set to IN.

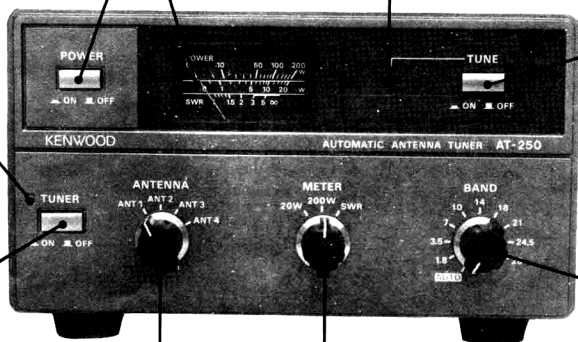

- **TUNER switch**

ON: Transmit signal passes through the antenna tuner. Receive signal depends on the RX IN-OUT switch setting (rear panel) and the TUNER switch setting.

OFF: The antenna tuner is "through" in all modes.

- **BAND switch**

Set to the desired ham band between 1.9 and 28 MHz, corresponding to the frequency to be used. With a TS-430 transceiver, set the switch to AUTO. The desired band setting is automatically selected by the TS-430.

- **ANTENNA switch**

Since 4 antennas can be connected to the unit, select the desired antenna when changing frequency or bands.

- **METER switch**

Used to select power or SWR indication. For power indication, 20 W or 200 W can be selected. For SWR indication, set the switch to SWR. No calibration is required, since this is an automatic instrument.

• **DC/AC switch**

Used to select DC or AC power source. Be sure to set the switch to DC or AC, depending on the power source selected.

• **RX IN-OUT switch**

Before shipment, this switch is set to OUT. With this setting, only a transmit signal passes through the antenna tuner. With the switch set to IN, both transmit and receive signals pass through the antenna tuner.

• **ACC jack**

An input jack for controlling the AT-250. Using the control cable supplied, connect the transceiver to this jack.

Detail of the AT-250 ACC terminal

RL1
(transmit information input for TS-430, 13.8 V when transmitting)

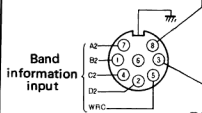

RL2
(transmit information input for transceiver other than TS-430, grounded when transmitting)

View from the rear panel

The following are band informations fed to the ACC jack.

Band	D2	C2	B2	A2	WRC
1.8	L(0)	L(0)	H(1)	L(0)	L(0)
3.5	L(0)	L(0)	H(1)	H(1)	L(0)
7	L(0)	H(1)	L(0)	H(1)	L(0)
10	L(0)	H(1)	H(1)	L(0)	H(1)
14	L(0)	H(1)	H(1)	H(1)	L(0)
18	H(1)	L(0)	L(0)	L(0)	H(1)
21	H(1)	L(0)	L(0)	L(0)	L(0)
24.5	H(1)	L(0)	L(0)	H(1)	H(1)
28	H(1)	L(0)	L(0)	H(1)	L(0)

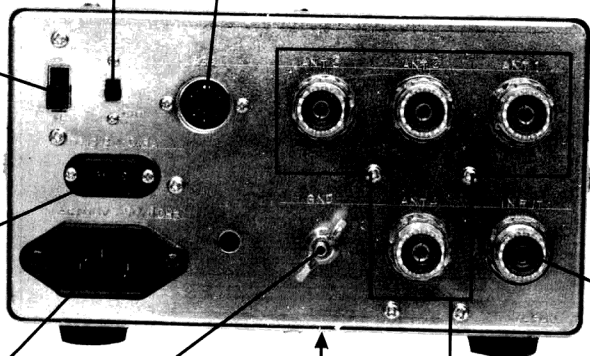

• **AC power connector**

When AC power (120, 220 or 240 V selectable) is to be used, connect the supplied AC cable here.

• **POWER VOLTAGE SELECTOR switch**

With this switch, on the bottom panel, select your local line voltage.

• **INPUT jack**

Input jack for the antenna tuner. Connect the transceiver antenna jack to this INPUT jack.

• **DC power connector**

When DC power (13.8 V) is to be used, connect here.

• **GND terminal**

GND terminal for the AT-250. Connect the transceiver GND terminal to this terminal. Grounding the terminal prevents TVI and BCI.

• **ANT 1 - ANT 4 jacks**

Coaxial antenna jacks. Connect antennas corresponding to your operating frequency range.

SPECIFICATIONS

1. Frequency range	All amateur bands from 1.8 — 29.7 MHz
2. Input impedance	50 ohms unbalanced
3. Output impedance	20 — 50 ohms unbalanced
4. Insertion loss	0.8 dB or less
5. Pass through power	100W (200W PEP)
6. SWR value for motor stop	1.2:1 or less
7. Min. power for activation	3W
8. Max. tuning time	Within 15 seconds
9. Power meter (peak value reading)	± 10% at 100 W (Meter Switch 100W Position) ± 10% at 10W (Meter Switch 10W Position)
10. Power consumption (current)	15W AC 13.8V DC 600 mA
11. Power requirement	120V, 220V, or 240V AC selectable 13.8V (12–16) DC
12. Dimensions	W174 (174) x H96 (107) x D257 (289) mm () shows projections included.
Weight	4.2 kg (9.24 lb.)
13. Package dimensions	W385 x H167 x D264 mm Capacitance: 0.017 m ³
14. Semiconductors	ICs 13 FETs 2 Transistors 31 Diodes 77

ACCESSORIES

Remote cable (A)	1
Remote cable (B)	1
AC power cable	1
Grounding wire	1
Instruction manual	1

Specifications may be subject to change without notice for technical improvement.

A product of
TRIO-KENWOOD CORPORATION
17-5, 2-chome, shibuya, shibuya-ku Tokyo 150, Japan

TRIO-KENWOOD COMMUNICATIONS
1111 West Walnut Street, Compton California 90220, U.S.A.
TRIO-KENWOOD COMMUNICATIONS, GmbH
D-6374 Steinbach TS, Industriestrasse 8A, West Germany
TRIO-KENWOOD ELECTRONICS, N.V.
Leuvensesteenweg 504, B-1930 Zaventem, Belgium
TRIO-KENWOOD (AUSTRALIA) PTY. LTD.
4E Woodcock Place, Lane Cove N.S.W. 2066, Australia

SCHEMATIC DIAGRAM

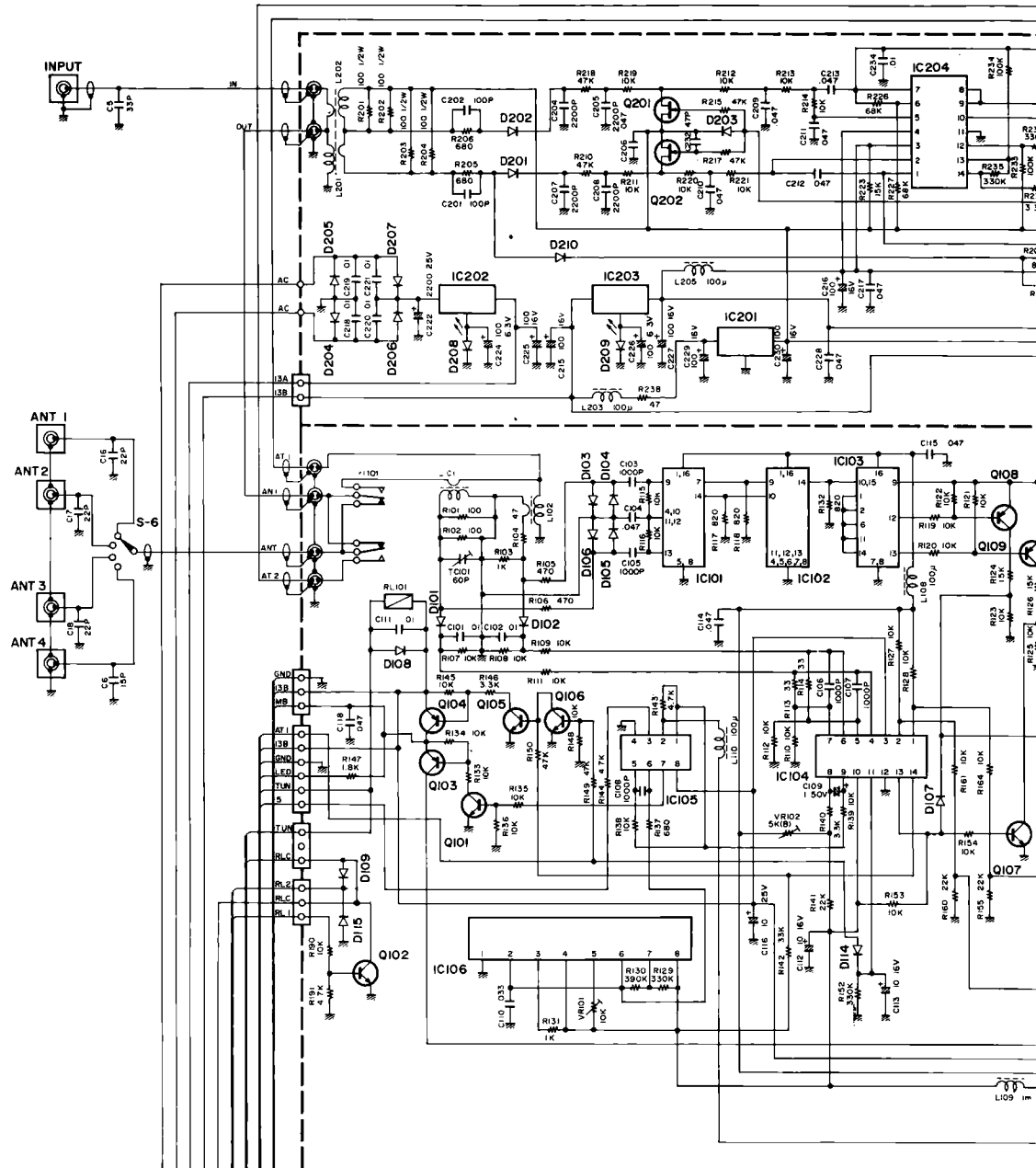

CONTROL UNIT (X53-1360-00)

- | | | |
|-------------------|---------------------|--------------|
| IC 101 : HD1016 | Q201, 202 | : 2SK30(GR) |
| IC 102 : HD10131 | Q102 | : 2SC2235(O) |
| IC 103 : HD10125 | Q10, 115, 118, 119 | : 2SA950(O) |
| IC 104 : NJM2901 | Q104 | : 2SA966(O) |
| IC 105 : NJM2904D | Q103 | : 2SA984K(E) |
| IC 106 : NE555P | Q108, 109 | : 2SA1015(Y) |
| | Q101, 105, 106, 107 | : 2SC1815(Y) |
| | 111, 114, 116, 121 | : 2SC2120(O) |
| | Q112, 113, 117, 120 | |
| | Q1, 2 | : 2SC1815(Y) |

- IC201 : μ PC14305H
 IC202 : μ PC14312H
 IC203 : μ PC78L08A
 IC204 : MB3614
 IC205 : NJM2903D
- IC 1 : SN74LS145N
 IC 2 : MC74HC157

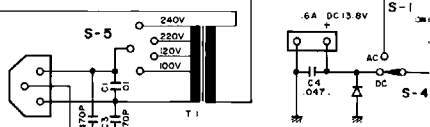

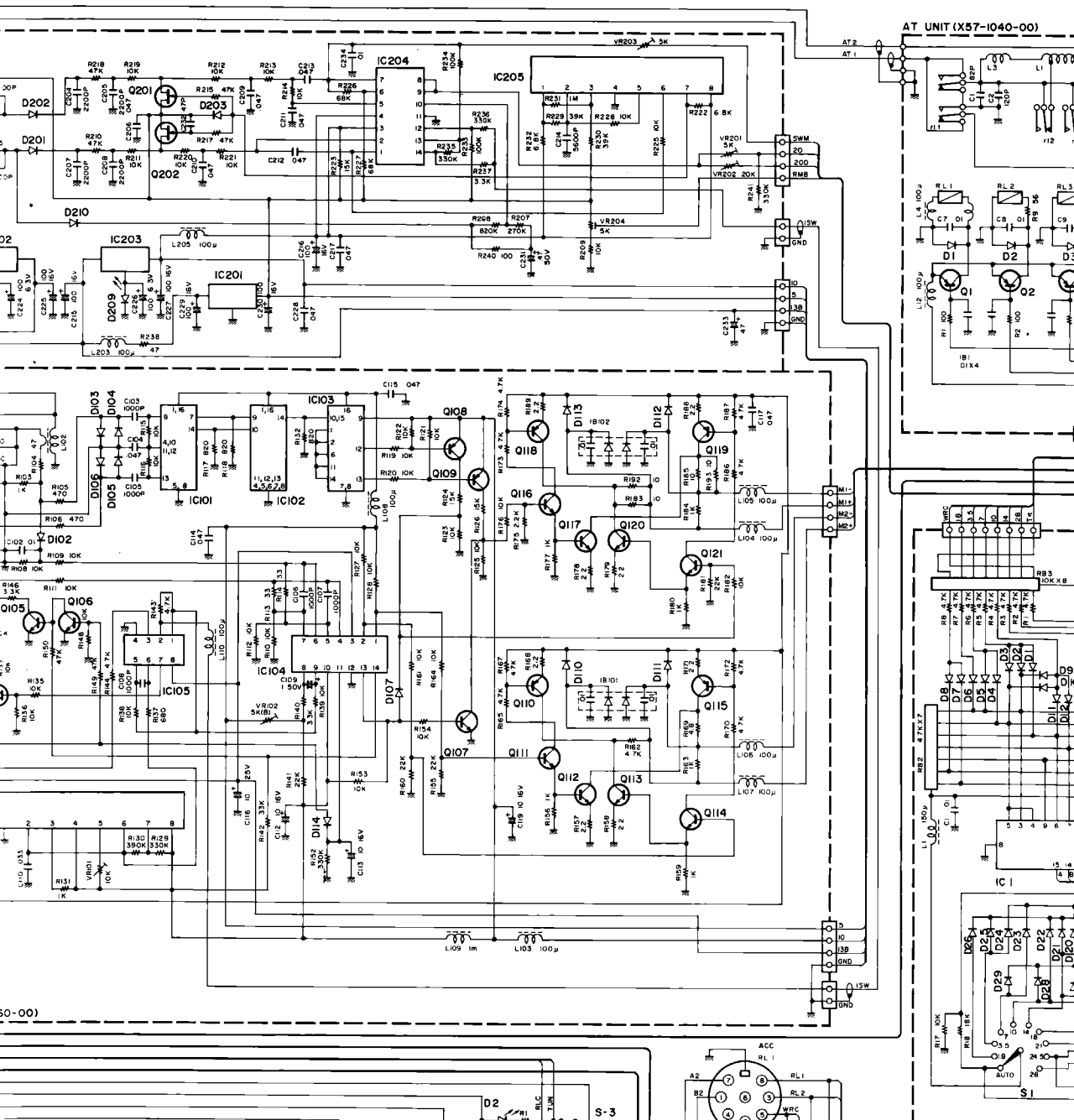

- 2SK30(G)
 - 2SC2235(O)
 - 2SA950(O)
 - 2SA966(O)
 - 2SA984K(E)
 - 2SA1015(Y)
 - 2SC1815(Y)
 - 2SC1201(O)
 - 2SC1815(Y)
- | | |
|----------------|----------|
| D203 ~ 106 | : IS\$99 |
| D101,102 | : IN60 |
| D108,110 ~ 114 | : IS1555 |
- | | |
|------------|----------|
| D204 ~ 207 | : V06C |
| D208,209 | : LT800P |
| D201,210 | : IS1587 |
| D202 | : IS1007 |
| D203 | : IS1555 |

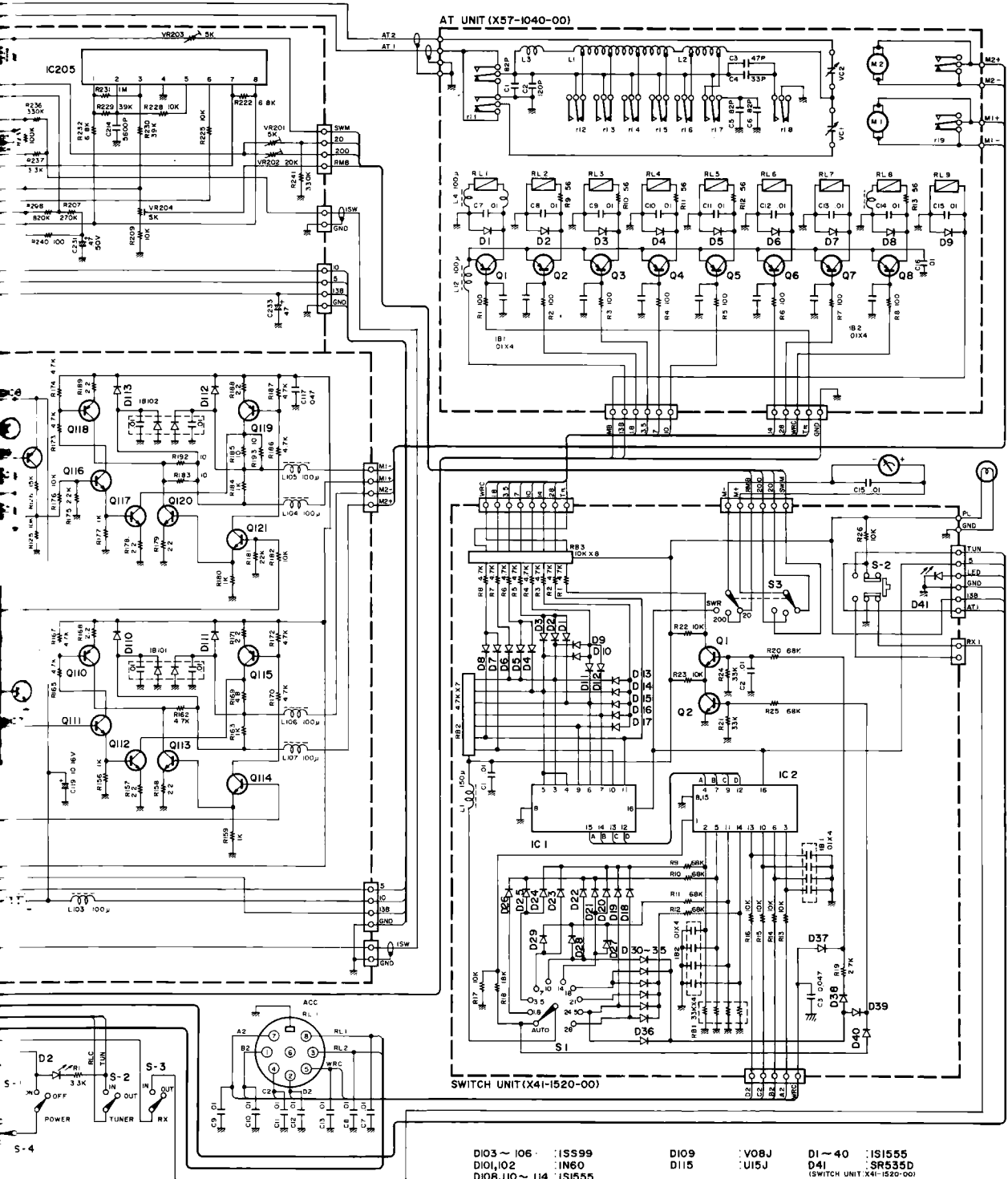

D103 ~ 106	: IS599	D109	: V08J	D1 ~ 40	: IS1555
D101,102	: IN60	D115	: U15J	D41	: SR535D
D108,110 ~ 114	: IS1555				(SWITCH UNIT X41-1520-00)
		D1 ~ 9	: IS1555		
			(AT UNIT X57-1040-00)		
D204 ~ 207	: V06C				
D208, 209	: LT800IP				
D201, 210	: IS1587				
D202	: IS1007				
D203	: IS1555				