

HIGH STABILITY
CO-1303D

75mm OSCILLOSCOPE

INSTRUCTION MANUAL

CO-1303D

CONTENTS

	Page
1. Features	2
2. Specifications	3
3. Circuit Description	5
4. Operating Instructions	6
5. Applications	15
6. Caution on Handling the Scope	19
7. Adjustment	20
8. Maintenance	24
9. Parts List	26
10. P.C. Board	28
11. Schematic Diagram	29
12. Block Diagram & External View	29

1. FEATURES

The KENWOOD CO-1303D Oscilloscope is a highly sensitive and stable oscilloscope employing a 75 mm cathode ray tube. Its unique design enables operation.

Make the most of the oscilloscope by carefully reading this instruction manual.

Features

- A vertical-axis sensitivity of better than 10 mV/DIV and a frequency response from DC to 5 MHz.
- DC amplifiers are used for both vertical and horizontal axis.
- All transistorized circuitry provides low power consumption and low heat generation.
- Compact and lightweight, easily portable.
- The angle of bright line displayed on the cathode ray tube can be easily corrected at the rear of the oscilloscope without removing the case.
- The cathode ray tube uses "blue-green" (B31) phosphor to provide easier observation, excellent luminance and improved contrast.
- Direct deflection terminals for the vertical axis are provided to permit monitor at high frequencies.

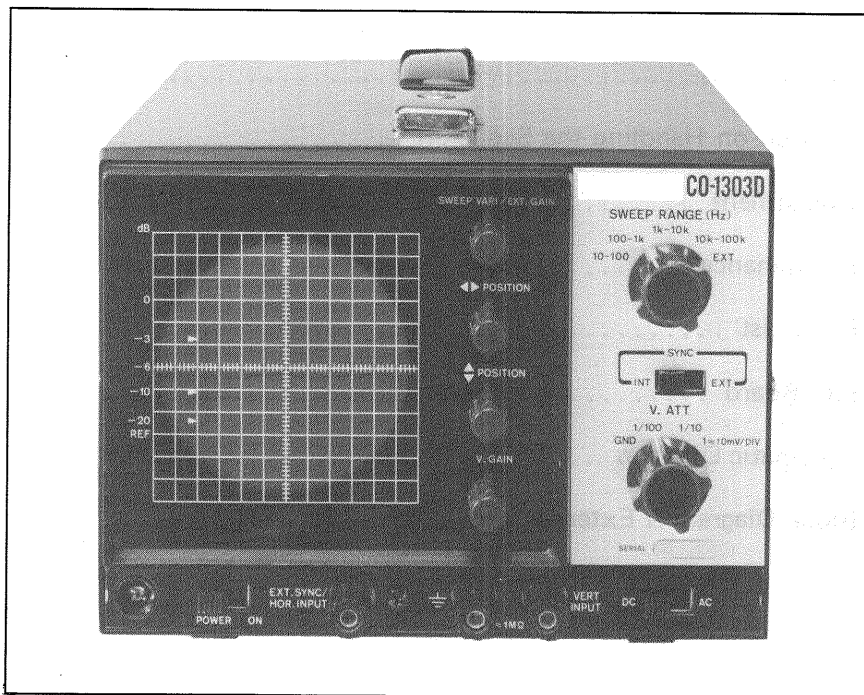

2. SPECIFICATIONS

CATHODE RAY TUBE	:	75ARB31
VERTICAL AMPLIFIER		
Deflection sensitivity	:	10 mV/DIV or better
Frequency response	DC	: DC to 5 MHz (-3dB)
	AC	: 2 Hz to 5 MHz (-3dB)
Input impedance	:	1 M Ω shunted by 35 pF max
Overshoot	:	5% or less
Attenuator	:	1, 1/10, 1/100 multiplier within $\pm 5\%$
Gain control range	:	Continuously variable range greater than 22 dB
Rated maximum input voltage	:	300 V (DC + AC peak) or 600 Vp-p
HORIZONTAL AMPLIFIER		
Deflection sensitivity	:	300 mV/DIV or better
Frequency response	:	DC to 250 kHz with EXT. GAIN Control set at maximum DC to approx. 40 kHz with EXT. GAIN Control set at mid-range
Input impedance	:	1 M Ω ($\pm 20\%$) shunted by 35 pF max. (SYNC \rightarrow INT)
Attenuator (EXT. GAIN)	:	Continuously variable to zero
Rated maximum input voltage	:	100 Vp-p
SWEEP CHARACTERISTICS		
Sweep frequency	:	10 Hz to 100 kHz continuously variable in 4 ranges
Sweep linearity	:	Within 5%
Synchronizing	:	Negative synchronizing (both INTERNAL and EXTERNAL)
Signal amplitude requirement for synchronization	:	INTERNAL: More than 1 DIV deflection on cathode ray tube screen EXTERNAL: More than 2 Vp-p
INTENSITY MODULATION		
Required signal	:	25 Vp-p

SPECIFICATIONS

4

DIRECT DEFLECTION TERMINALS

Deflection sensitivity : 10 V/DIV or better
Input impedance : 2.2 M Ω shunted by 25 pF or less

POWER REQUIREMENT : AC 230/117 V
50/60 Hz, 16 W

DIMENSIONS : Width: 7-1/2" (190 mm)
Height: 6" (154 mm)
Depth: 11-27/32"(300 mm)
Overall dimensions include all protrusions

WEIGHT : Approx. 8.36 lbs. (3.8 kg)

ACCESSORY

Replacement fuse : 0.3A 2
0.5A 2
Input cord (CA-46) 1
Instruction manual 1

3. CIRCUIT DESCRIPTION

Refer to BLOCK DIAGRAM and SCHEMATIC DIAGRAM (see P29)

Vertical Circuit

The input signal connected to VERT INPUT terminal is applied to an attenuator through the AC-DC switch.

The attenuator provides three steps (1, 1/10, 1/100).

The vertical amplifier is a highly stable direct coupled differential amplifier employing an FET (Q102, Q103) and silicon transistors Q104 to Q111, amplifies and provides a gain of approx. 61 dB.

Horizontal Circuit

The horizontal circuit consists of a saw-tooth generator for a time base and a horizontal amplifier circuit. The saw-tooth generator comprising transistors Q112 and Q113 employs a unique circuit with facilities for stabilizing the DC level.

The horizontal amplifier is a direct coupled highly stable differential amplifier employing an FET (Q114) and silicon transistors Q115 and Q116. The frequency response is from DC to greater than 250 kHz. It allows operation at slow sweep speeds below 1 Hz through the use of the HOR EXT. INPUT terminals. The horizontal amplifier provides a gain of approx. 35 dB, which may be varied by approx. 10 dB using the H. GAIN control.

Power Supply Circuit



The power supply circuit provides voltage -8 V and $\pm 15\text{ V}$, stabilized by zener diodes D105, D106 and D109, $+170\text{ V}$ for the collectors of the final amplifier stage and -1300V for the cathode ray tube circuit.

4. OPERATING INSTRUCTIONS

The markings of controls and terminals on the front panel are given in the following table. When reading the table, refer to the attached EXTERNAL VIEW. (see P29)

(FRONT PANEL)

REF. NO.	PANEL MARKING	DESCRIPTION
(1)	(NEON PILOT)	Illuminated when the scope is in the operating condition.
(2)	POWER	Power on-off switch. When this switch is placed in ON position, the scope is brought to its operating condition.
(3)	EXT. SYNC/HOR. INPUT	Input terminal for an external synchronizing and an external horizontal signal. Use grounding terminal (4) as the common grounding terminal.
(4)		Grounding terminal.
(5)	VERT INPUT	Input terminal for the vertical signal. Note that terminals (4) and (5) are spaced for inserting a dual banana plug.
(6)	AC - DC	Selector switch for the vertical input coupling capacitor. In the DC position, the switch directly couples the VERT INPUT terminal (5) and V. ATT (7) and, therefore, allows the vertical amplifier to amplify input signals ranging from DC. In the AC position, a capacitor is placed between the vertical attenuator V. ATT (7) and VERT INPUT (5) and, therefore, the DC component of input signal is blocked thereby allowing observation of only the AC component.

REF. NO.	PANEL MARKING	DESCRIPTION
(7)	V. ATT	<p>Vertical attenuator. The vertical attenuator provides facilities to attenuate the signal voltage connected to the VERT INPUT terminal (5) to a suitable level before being applied to the vertical amplifier.</p> <p>When this attenuator is set to position 1, the signal applied to the VERT INPUT terminal (5) is directly coupled to the vertical amplifier. In positions 1/10 and 1/100, the attenuator attenuates the signal so that the input is reduced to 1/10 and 1/100 of the normal value, respectively.</p> <p>In GND position, the attenuator grounds the input of the vertical amplifier and opens the VERT INPUT terminal (5). The attenuator position GND is provided for making DC BAL adjustments.</p>
(8)	V. GAIN	<p>Vertical gain control. This control, operated in combination with vertical attenuator V. ATT (7), provides facilities to provide an appropriate amplitude on the cathode ray tube screen. If it is impossible to adjust the waveform to an appropriate amplitude by operating this control, turn the vertical attenuator V. ATT (7) to another position.</p>
(9)	 POSITION	<p>Vertical position control. The control provides facilities to move the signal waveform up and down over the cathode ray tube screen. Clockwise rotation of the control moves the waveform up over the screen.</p>
(10)	 POSITION	<p>Horizontal position control. The control provides facilities to move the signal waveform to the left or right over the cathode ray tube screen. Clockwise rotation of the control moves the waveform to the right.</p>

OPERATING INSTRUCTIONS

8

REF. NO.	PANEL MARKING	DESCRIPTION
(11)	SWEEP RANGE	<p>Sweep-frequency selector switch, together with SWEEP VARI/EXT. GAIN (12), provides variable sweep frequencies allowing the appropriate number of cycles of signal waveform on the cathode ray tube screen for easy observation. Position markings 10 – 100, 100 – 1 k and so on represent sweep frequencies. In position EXT, this switch connects the horizontal amplifier via the SWEEP VARI/EXT. GAIN control (12) to the HOR EXT. INPUT terminal (3).</p>
(12)	SWEEP VARI/EXT. GAIN	<p>Sweep frequency fine adjustment and external signal gain control. When the SWEEP RANGE selector switch (11) is in the internal frequency range (10 – 100 k), this control acts as the fine adjustment of sweep frequency to the number of the cycles in the signal waveform on the cathode ray tube screen.</p> <p>When the SWEEP RANGE selector switch (11) is in the EXT position, this control provides facilities to adjust the gain of the signal connected to the HOR EXT. INPUT terminal (3) to change the amplitude of the horizontal signal on the cathode ray tube screen.</p> <p>Note that the horizontal frequency response varies with the position of this control.</p> <p>(Refer to Specifications)</p>
(13)	(GRATICULE)	<p>The graticule is made of acrylic resin and has engraved markings to aid in analyzing the waveform on the cathode ray tube screen.</p> <p>There are dB scales on the graticule as 0, –3, –6, –10 and –20 dB so calibrated that it provides a level corresponding to an amplitude of 6 DIV above the REF line.</p> <p>Thus, these graduations may be conveniently used for measuring signal levels in frequency response measurements.</p>
(14)	SYNC INT-EXT	<p>At the INT position, synchronization is effected by input voltage and, at the EXT position, the signal voltage applied to the "3" terminal is synchronized.</p>

(BOTTOM PANEL)

REF. NO.	PANEL MARKING	DESCRIPTION
(15)	D.C. BAL	DC balance adjustment for the vertical amplifier. This adjustment should be so adjusted that the trace line remains stationary as the V. GAIN control (8) is rotated from full clockwise to full counterclockwise.
(16)	HOR. GAIN	The horizontal gain control provides a means to adjust the amplitude of horizontal bright line.

(REAR PANEL)

REF. NO.	PANEL MARKING	DESCRIPTION
(17)	INTENSITY	The intensity adjustment provides a means to adjust the brightness of the waveform appearing on the cathode ray tube screen. Clockwise rotation of this control increases the waveform brightness.
(18)	FOCUS	The focus adjustment provides the means to adjust the waveform appearing on the cathode ray tube for maximum clarity.
(19)	Z AXIS INPUT	Terminal for intensity modulation. This terminal requires an AC voltage of approx. 25 Vp-p to blank the screen. When a positive signal is applied to this terminal, the waveform intensity is increased. If a negative signal is applied, the intensity is reduced. This terminal is not effective when at DC.
(20)	GND	Grounding terminal.
(21)	V. DIR	Direct deflection terminals. They can be directly connected to the CRT vertical deflection plates by switching the DIR-NOR selector switch (22) to observe waveforms of high frequencies.

OPERATING INSTRUCTIONS

10

REF. NO.	PANEL MARKING	DESCRIPTION
(22)	DIR-NOR	Switch for the vertical deflection plates. In the NOR position, it connects the CRT to the amplifier for measurements through input terminals (4) and (5). In the DIR position, the internal amplifier is put out, enabling measurements to be made through input terminals (20) and (21), where signals under measurement are directly passed to the CRT deflection plates.
(23)	(CRT)	The bright line on the cathode ray tube can be aligned by turning this CRT mounting plate.
(24)	(POWER CORD)	

GENERAL OPERATION

Apply the signal voltage to be observed to the $\frac{1}{\equiv}$ (4) and VERT INPUT terminal (5) using the cable supplied with the unit. Connect the black cable to the grounding terminal $\frac{1}{\equiv}$ (4) and the red cable to the VERT INPUT terminal (5). Adjust the attenuator V. ATT (7) and V. GAIN control (8) until the waveform appearing on the cathode ray tube screen provides an amplitude of approx. 6 DIV.

Then, set the SWEEP RANGE selector switch (11) to the range including the frequency of the signal voltage to be observed or the next counterclockwise range.

Turn the SWEEP VARI/EXT. GAIN control (12) until the screen displays a waveform with the number of cycles adequate for observation (generally three cycles).

If the waveform includes only one wave, it means that the sweep frequency of time base is the frequency of the signal under observation. If the waveform includes five cycles it means that the sweep frequency of time base is 1/5 of the signal frequency.

Turn the AC-DC selector switch (6) to the DC position when it is desired to measure the DC component of the signal under observation, or to observe a frequency below 10 Hz.

When it is desired to observe the AC component only, turn the above selector switch to the AC position. It should be noted that a positive (+) signal on the vertical amplifier causes the trace to move up. A positive signal applied to the horizontal input causes a deflection to the left.

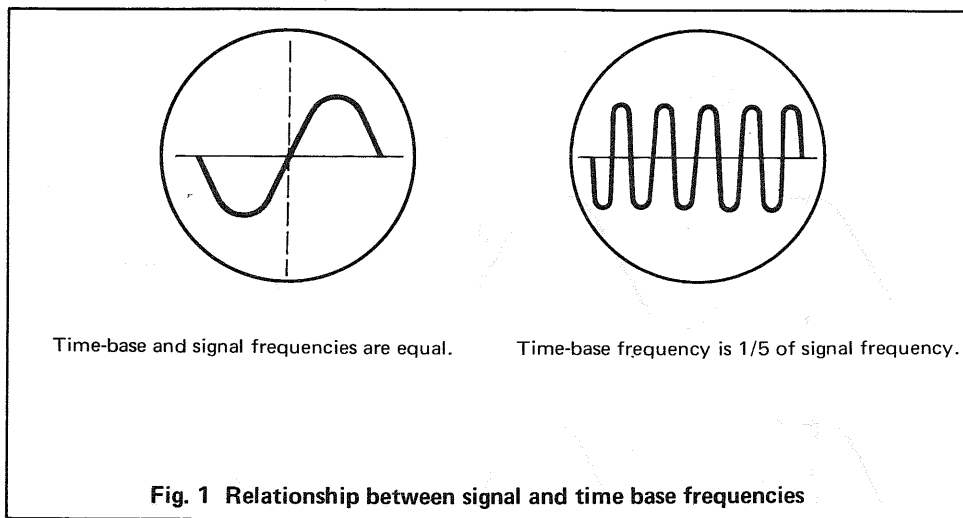

Position the waveform by adjusting the vertical position control (9) and horizontal position control (10) appropriately.

If the waveform includes a DC component, it is shifted up or down depending on the polarity of the component. In this case, correct the position of the waveform by means of the vertical position control (9). If the waveform cannot be brought within the screen of the cathode ray tube, it means a large DC component is included in the signal under observation. In such a case, turn the V. ATT (7) or V. GAIN control (8) counterclockwise until the waveform is brought back to an appropriate position.

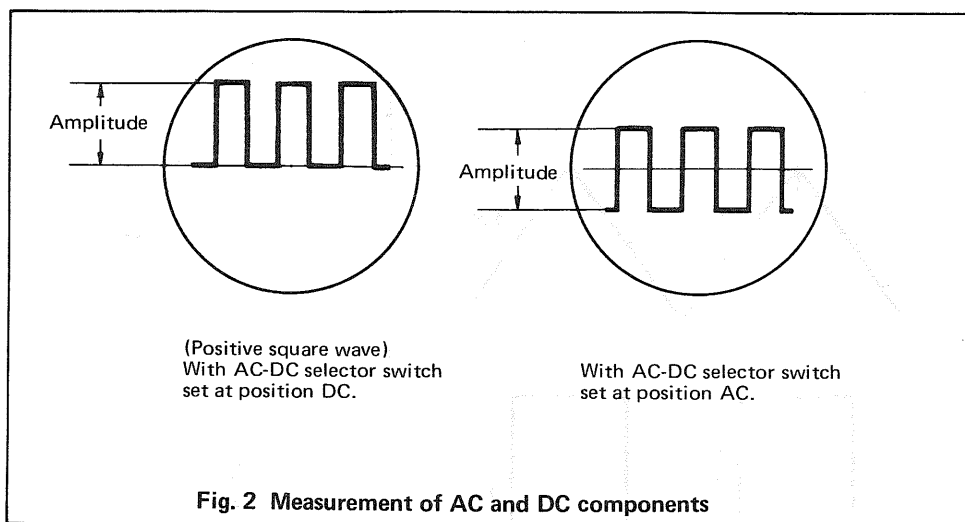

Any voltage measurements made on an oscilloscope are made in p-p or peak values. Because the effective, or rms value is often the one of interest, the following table gives the conversion between p-p and rms values for a number of common waveforms.

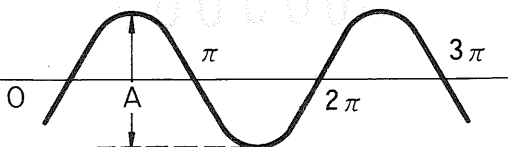
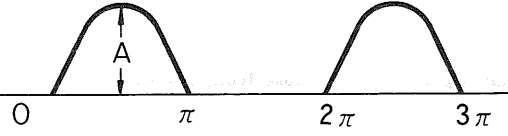
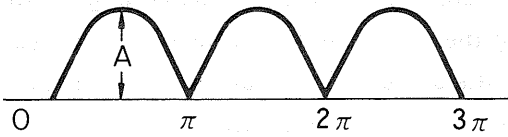
Waveform	Effective Value (r m s)
	$\frac{A}{2\sqrt{2}} = 0.354A$
	$\frac{A}{2} = 0.5A$
	$\frac{A}{\sqrt{2}} = 0.707A$

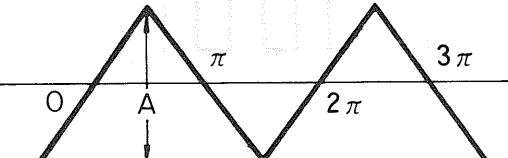
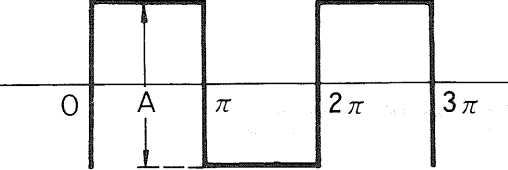
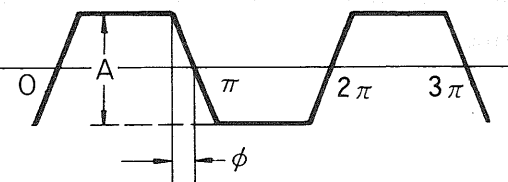
Waveform	Effective Value (r m s)
	$\frac{A}{2\sqrt{3}} = 0.288A$
	$\frac{A}{2} = 0.5A$
	$\frac{A}{2} \sqrt{1 - \frac{4\phi}{2\pi}}$

MEASUREMENT BY LISSAJOUS' FIGURES

(a) Frequency measurement

Lissajous' figures are a widely used method for measurement of the frequency of a signal. To make a frequency measurement using this method, proceed as follows:

Set the SWEEP RANGE selector switch (11) to the EXT position. Connect a signal generator across the HOR EXT. INPUT terminals (3) and $\overline{\text{---}}$ (4) and adjust the generator output until the waveform appearing on the cathode ray tube screen provides a trace width of approx. 6 DIV. Apply the unknown frequency signal across the $\overline{\text{---}}$ (4) and VERT INPUT (5) terminals and adjust the V. GAIN control (8) until the waveform appearing on the cathode ray tube screen has an amplitude of approx. 6 DIV.

Slowly vary the output frequency of the generator until the waveform appears as one of the following figures.

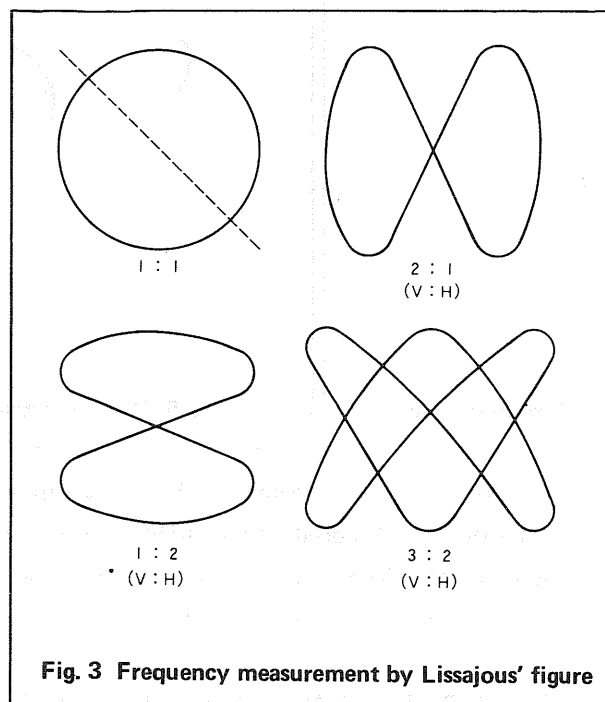

The frequency of signal oscillator and the unknown frequency are equal when the waveform becomes a straight line, an ellipse or circle. The figure comes to a standstill only when there is such relation between the frequency of the signal generator and the unknown frequency that the former is an exact multiple of the latter or vice versa. This makes it possible to find the unknown frequency through a calculation.

The frequency ratio is determined by observing the number of tangent points on either vertical side and on either top or bottom. The frequency ratio is the ratio between these tangents. Several examples are given in the illustration.

(b) Measurement of phase difference

Apply the two signals having the same frequency (for instance the R and L signals of a stereo signal) to HOR EXT. INPUT (3) and VERT INPUT terminals (5) in the same manner as described in (a). A straight line running from the upper left corner to the lower right corner of the screen indicates both signals are in phase with each other. Increasing phase difference causes the straight line on the cathode ray tube screen to gradually turn into an ellipse. When the ellipse turns into a circle or an ellipse with a vertical or horizontal axis the signals are 90° out of phase with each other.

To make the measurement of the phase difference of the two signals mentioned above, measure the horizontal deflection of the overall figure and the length of figure on the horizontal axis, which are given as X and x respectively in following figure. And the phase difference θ is given by $\text{Sin } \theta = x/X$.

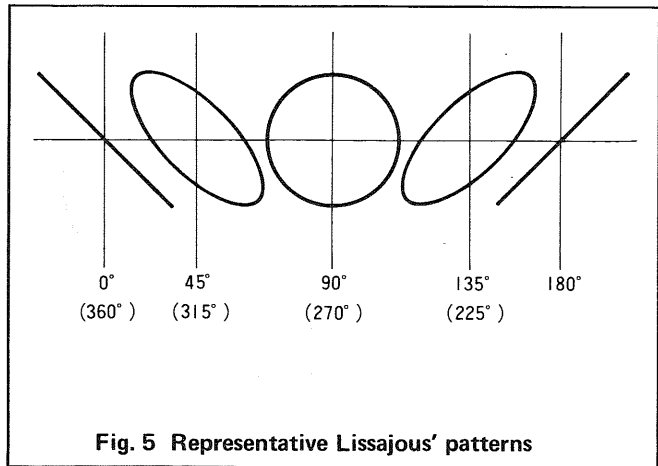
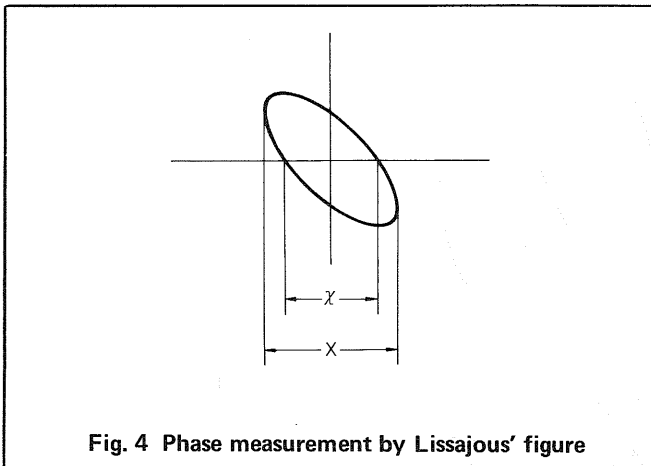

Note that if the EXT. GAIN control (12) is kept in the fully clockwise position in the above measurement, the vertical and horizontal signal phase difference of the oscilloscope is essentially zero up to about 2 kHz. Above 2 kHz, however, the unit will have a vertical and horizontal signal phase difference. Take the above fact into consideration when making phase difference measurements.

Also, it should be noted that if EXT. GAIN control (12) is not fully clockwise, the range of frequencies at which the vertical and horizontal signal phase difference is zero is reduced and will be approx. 500 Hz when the control is set at its mid-point.

5. APPLICATIONS

(a) Frequency Response Measurement of an Audio Amplifier

Connect the sine wave output of a signal generator to the input terminal of the audio amplifier under measurement. Connect the VERT INPUT (5) and --- (4) terminals of the oscilloscope across the speaker output terminals of the amplifier. The amplifier should be feeding a load resistor of the proper value.

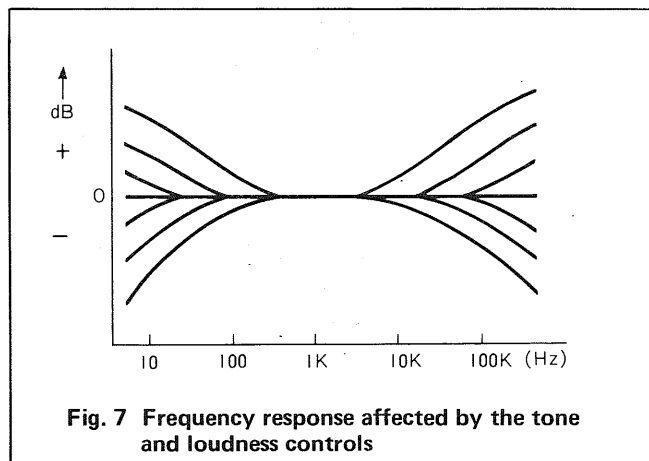
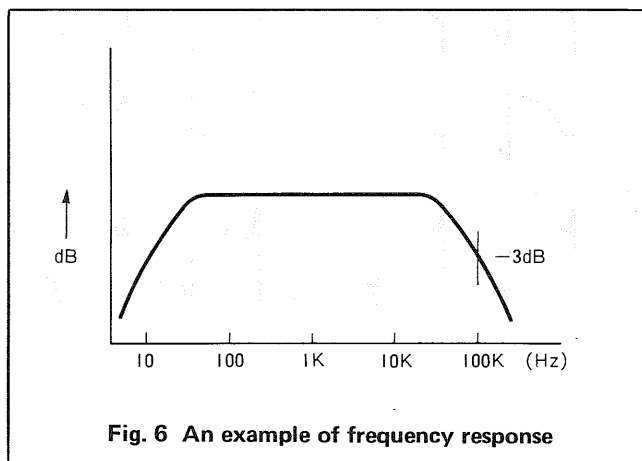

With the output voltage of the signal generator set at a constant value, change the output frequency of the generator and read the amplitude of the waveform in dB on the cathode ray tube screen using the dB scale for various major frequencies. Plot the amplitude readings thus obtained against the frequencies and you can obtain a general amplitude frequency characteristic as shown in the Fig. 6.

If the tone and/or loudness controls on the amplifier are adjusted appropriately, then the characteristic curve will be changed as shown in the Fig. 7.

Note that the dB scale of this unit provides means to directly read the amplitude of a waveform on the cathode ray tube screen in dB, such as -3 and -6 dB.

(b) Measurement with Square Wave Signal

If a square wave signal is used in lieu of the sine wave signal in the above frequency characteristic measurement, the frequency characteristics of the audio amplifier can be roughly estimated from the various output waveforms of the square wave signal in accordance with the diagram shown in the page next.

	Frequency response of amplifier	Square wave output	
		100Hz	1 KHz
①	Gain reduced at high-frequency		
②	Gain rises at high-frequency		
③	Gain reduced at low-frequency		
④	Gain rises at low-frequency		
⑤	With loudness control set ON.		
⑥	Gain having waving characteristic curve		

(c) Measurements through the Direct Deflection Terminals

Although frequencies below 5 MHz can be measured through the internal amplifier, higher frequencies must be measured through the direct deflection terminals. For direct connection, set DIR – NOR switch (22) to DIR, and connect the signal to be measured, to DIR (21) and GND (20).

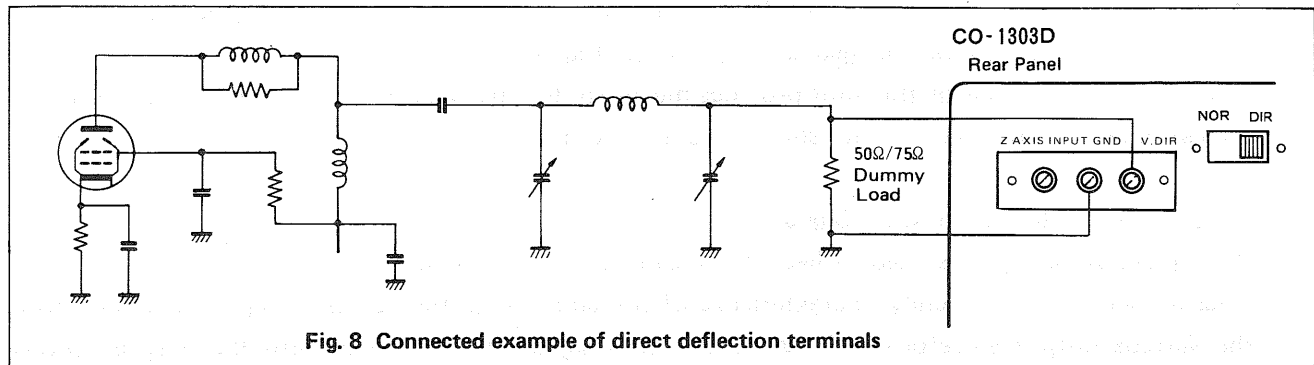

Fig. 8 Connected example of direct deflection terminals

Remark: The dummy load should be of a non-inductive type as this may affect high-frequency characteristics of the unit.

The direct deflection terminals, however, require an input level of 10 Vp-p to 100 Vp-p because of their low sensitivity. Also, since the direct connection to the deflection plate puts the sensitivity control out of the circuit, adjustment must be made on the source side of the set-up.

The followings are examples of observation of the output signals of communications instruments:

1) Modulation measurement

Make connections as shown in the Fig. 8. After obtaining a waveform on the CRT, measure maximum amplitude A and minimum amplitude B as shown in the Fig. 9. The degree of modulation can be found from the equation in the Fig. 9.

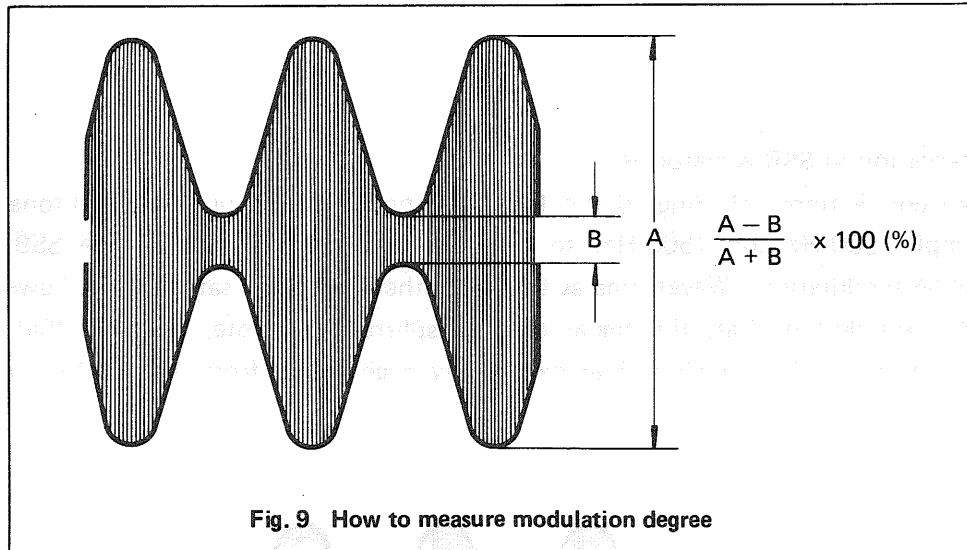

2) Measurement of Morse code envelopes

Employ the same connections as for the modulation measurement. Connect a high-speed keyer — an electronic keyer is preferable — to the key jack of the transmitter, and repeat dashes or dots to observe their waveform while adjusting SWEEP VARI (12).

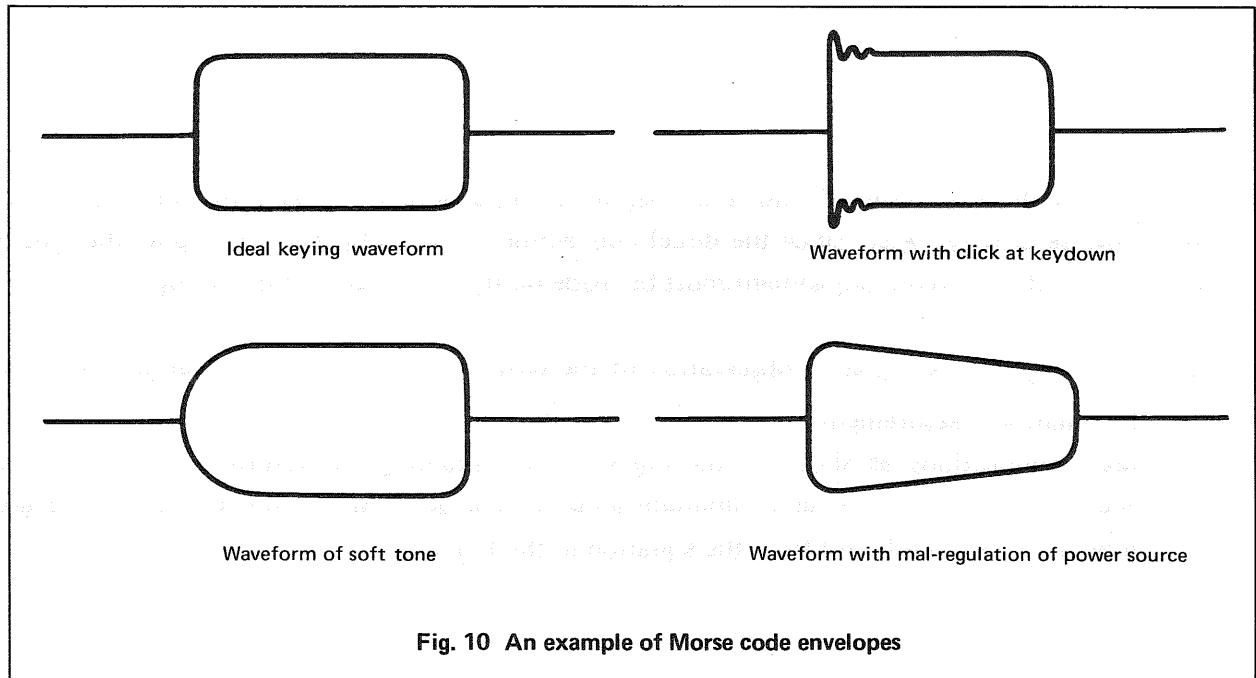

3) Observation of SSB waveforms

Make connections referring to the Fig. 8. Connect the output of a two-tone generator (for example, 500 Hz and 1500 Hz) to the microphone input jack of the SSB transmitter to observe modulation. Waveforms as shown in the Fig. 11 are satisfactory; however, if peaks or nodes are dull or flat, the signal may be spluttering. Note, however, that such distorted waveforms can also appear with an excessively large output from the two-tone generator.

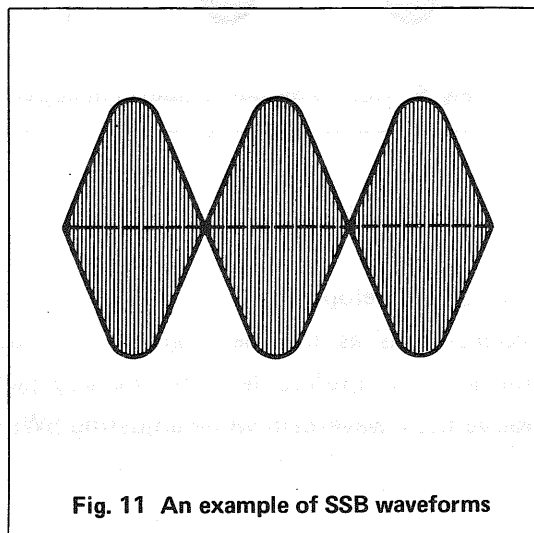

6. CAUTION ON HANDLING THE SCOPE

- (a) Do not operate this oscilloscope in a place where the set is exposed to direct sunlight. Otherwise, the unit may reach a high internal temperature with resultant unstable operation and, in some cases, result in damaged components.
- (b) Do not operate the set in a room where high temperature and high humidity prevail.
- (c) Do not operate the set in a place where mechanical vibrations prevail or near equipment which generate strong magnetic fields or impulse voltages.
- (d) When using another power source change the wiring for voltage conversion on the first wind terminal of power transformer within the set to an appropriate position depending on the source selected. Replace the existing fuse with 0.5 A fuse for operation from a 117 V power source or a 0.3 A fuse for 230 V power source operation (Refer to MAINTENANCE paragraph).
- (e) Do not allow the voltage across the VERT INPUT (5) and $\underline{\underline{\perp}}$ (4) terminals to exceed 600 Vp-p and that across HOR EXT. INPUT (3) and $\underline{\underline{\perp}}$ (4) terminals to exceed 100 Vp-p.
- (f) The trace line on the cathode ray tube screen changes its angular direction a little due to the earth's magnetic field when the set is placed in various directions.

7. ADJUSTMENT

(a) Adjustment of D.C. BAL

When the trace line is moved up or down as the V. GAIN control (8) is turned, adjust the D.C. BAL adjustment as follows:

First place the operating controls as follows: V. ATT (7) at GND, V. GAIN control (8) at fully counterclockwise position. Adjust \blacklozenge POSITION control (9) until the trace line is centered on the cathode ray tube screen.

Then, turn the V. GAIN control (8) clockwise and if the trace line shifts, insert a screwdriver with narrow tip (having a width of less than 2.5 mm) in the hole for D.C. BAL adjustment and fit the tip of the screwdriver in the center groove of trim-pot adjustment D.C.BAL. Slowly turn the trim-pot in such a manner that the shifted trace line is restored to its original position.

Repeat the above step several times until the trace line remains unmoved even though V. GAIN control (8) is turned.

Allow at least 15 minutes of operation for the unit to stabilize before making this adjustment.

(b) Adjustment of HOR. GAIN

1) Apply a signal of 3 V_{p-p} at approx. 1 kHz to the HOR. EXT. INPUT terminals (3) and $\underline{\underline{1}}$ (4). With SWEEP RANGE selector switch (11) set at the EXT position, turn the SWEEP VARI/EXT. GAIN control (12) to the fully clockwise position. Turn HOR. GAIN (16) with narrow tip screwdriver as above mentioned. Slowly turn the trim-pot until the trace line provides a horizontal deflection of 10 DIV and the set is calibrated for a horizontal sensitivity of 300 mV/DIV.

2) Set up the oscilloscope for internal sweep by placing the SWEEP RANGE selector switch (11) in a position other than EXT.

Apply an input signal to the $\underline{\underline{1}}$ (4) and VERT INPUT (5) terminals and adjust the V. GAIN control (8) until the waveform appearing on the cathode ray tube screen provides an amplitude of approx. 6 DIV.

Adjust SWEEP RANGE selector switch (11) and SWEEP VARI/EXT. GAIN control (12) until a normal waveform appears on the cathode ray tube screen. Adjust VR3 so as to set the horizontal deflection of the waveform to an appropriate length of deflection (for instance 10 DIV).

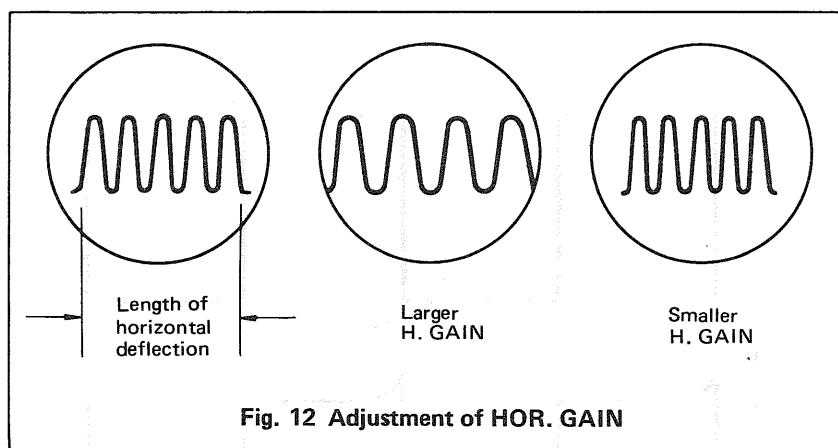

(c) Adjustment of V. ATT Frequency Correction

Remove the cabinet case from the unit.

CAUTION: The cathode ray tube socket pins carry voltage of approx. -1300 V. BE CAREFUL not to bring the hand or screwdriver into contact with the metal section of the socket while making these adjustments.

Apply a square wave signal of approx. 1 kHz to $\underline{\text{---}}$ (4) and (5) terminals.

With vertical attenuator V. ATT (7) set to position 1, adjust the output of the signal generator until the waveform appearing on the cathode ray tube screen provides an amplitude of approx. 6 DIV.

Turn SWEEP RANGE selector switch (11) to the 100–1K position and adjust the SWEEP VARI/EXT. GAIN control (12) so as to make the waveform include two to four cycles.

Check that the waveform under the above condition is a good square wave and then turn the vertical attenuator V. ATT (7) to position 1/10. Then, increase the output of signal generator 20 dB to make an amplitude of 6 DIV.

If necessary, adjust trimmer capacitor TC102 using an insulated (adjustment) screwdriver until the square wave is restored to its original configuration.

Repeat the previous steps with the vertical attenuator set to position 1/100 and adjusting trimmer capacitor TC101.

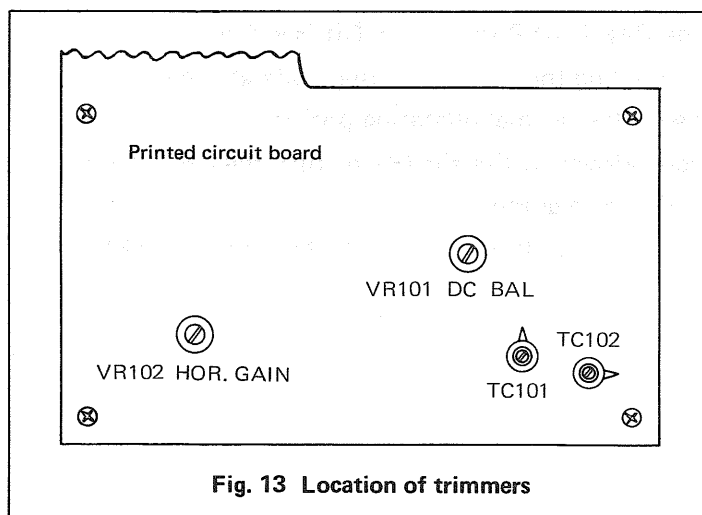

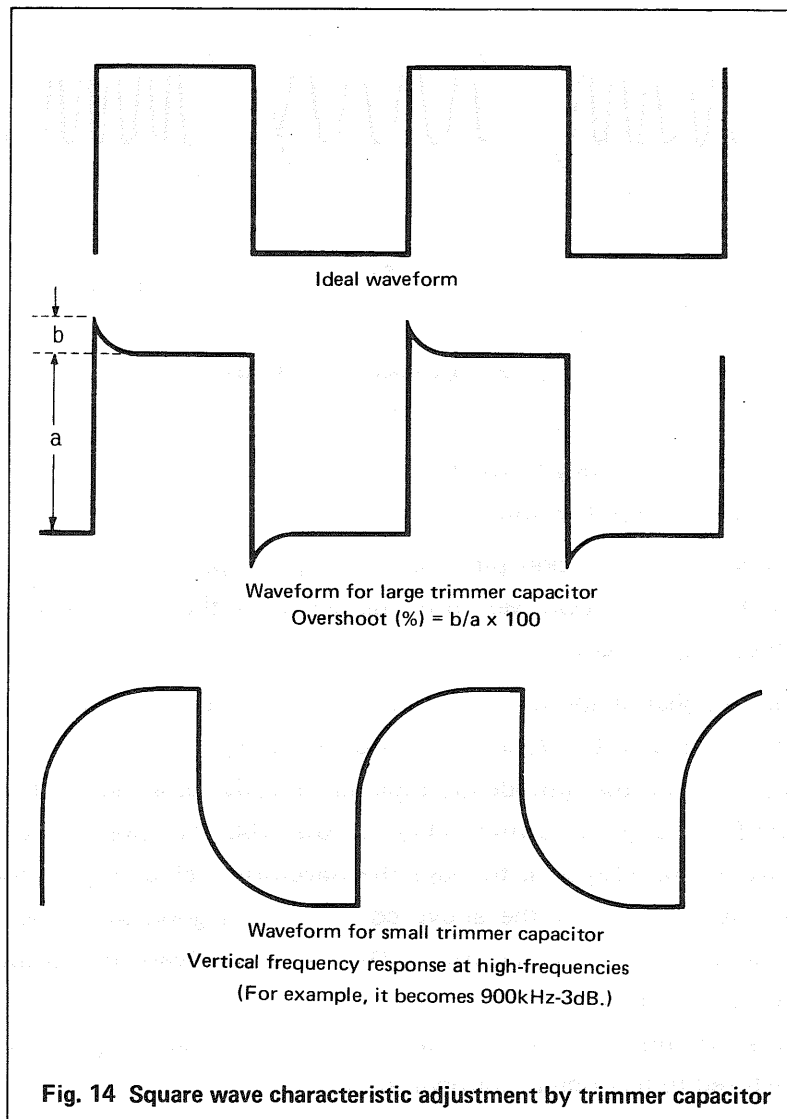

(e) Correction of Cathode Ray Tube Position for Tilt (see Fig. 15)

Loosen the screw (A) holding the CRT mounting plate at the rear.

Place the oscilloscope on the normal operating position.

Put the blade of a screwdriver in the slit (B) to turn the CRT mounting plate for setting the bright line correctly against the scale graduation.

Carefully tighten the screw (A) observing that the horizontal bright line is not deviated.

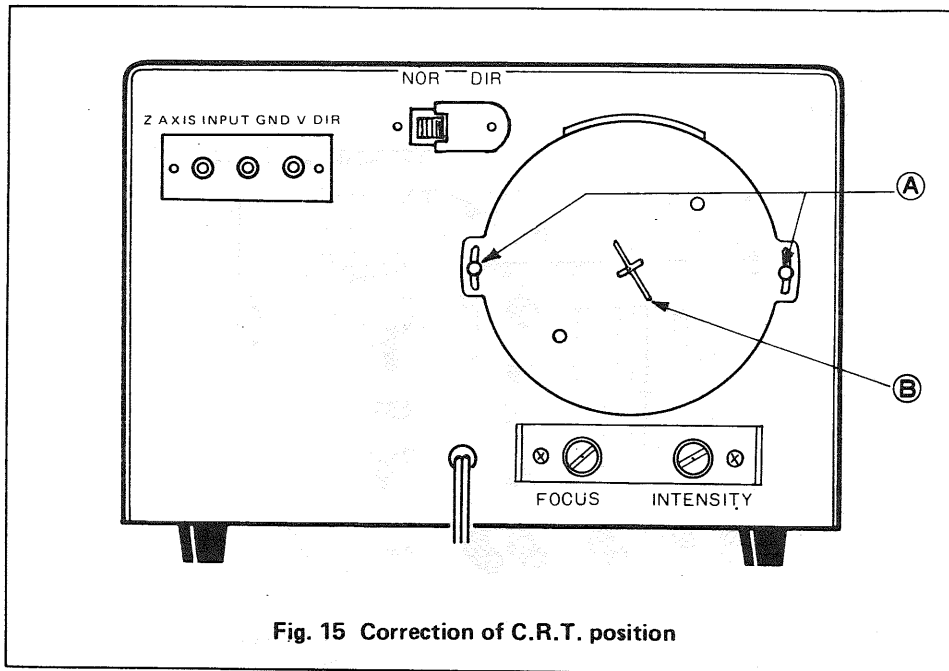

Fig. 15 Correction of C.R.T. position

8. MAINTENANCE

(a) Removal of Cabinet Case

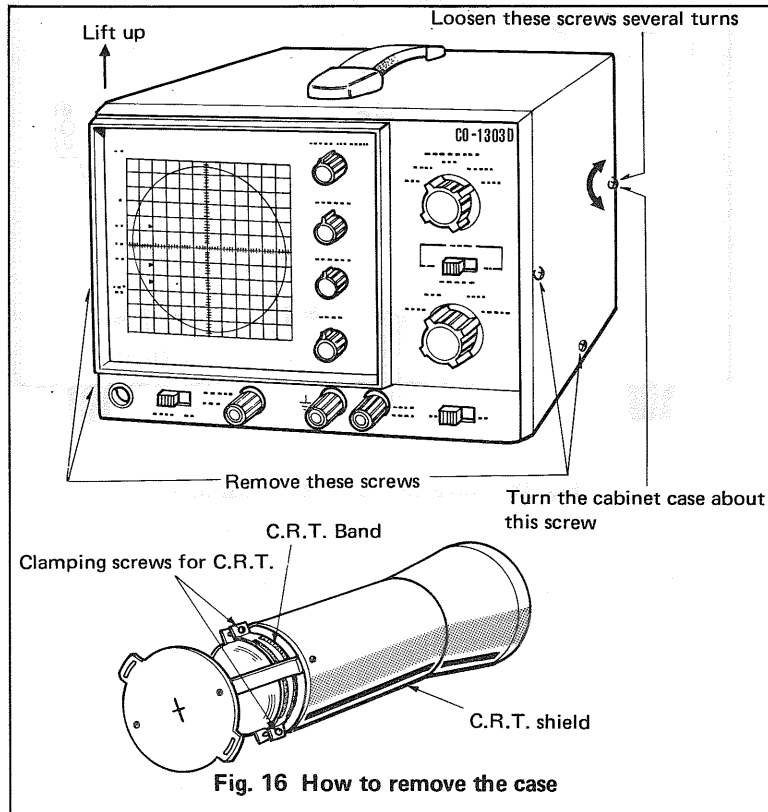

Fig. 16 How to remove the case

- 1) Remove four setscrews for the cabinet case from both side plates.
- 2) Loosen the screws located at the center rear sections of both side plates several turns.
- 3) Hold the handle of the cabinet case in your hand and lift the case up backward while rocking the case about the screws at the center rear sections of both side plates.

(b) Removal of Cathode Ray Tube

- 1) Remove the cabinet case from the unit.
- 2) Remove the socket from the cathode ray tube.
- 3) Remove two screws (A) holding the CRT mounting plate (see Fig. 15).
- 4) Pull out the CRT with mounting plate from the case.
- 5) Loosen two screws retaining the CRT band to remove the shielding plate from the CRT.

CAUTION: Handle the cathode ray tube with utmost care. When replacing the tube, BE CAREFUL to place the tube in the socket with the key positioned in the upper direction when viewed from the face.

(c) Removal of Panel

- 1) Remove the cabinet case.
- 2) Loosen mounting screws for control knobs (2 large knobs, 4 small knobs).
- 3) Unscrew the nut from the SWEEP RANGE selector switch shaft.
- 4) Remove the black screw between terminals (3) and $\underline{\underline{4}}$ (4).
- 5) Remove two screws from the lower section of the front panel.
- 6) Carefully draw the panel forward.

CAUTION: Handle the panel carefully. Rough handling may bend or crack panel.

(d) Voltage Conversion

- 1) To convert the power source voltage, first remove the power cord from the power source.
- 2) The power transformer is wired as shown in Fig. 17. If the oscilloscope is to be operated on another voltage, change the wiring and re-solder referring to Fig. 17.

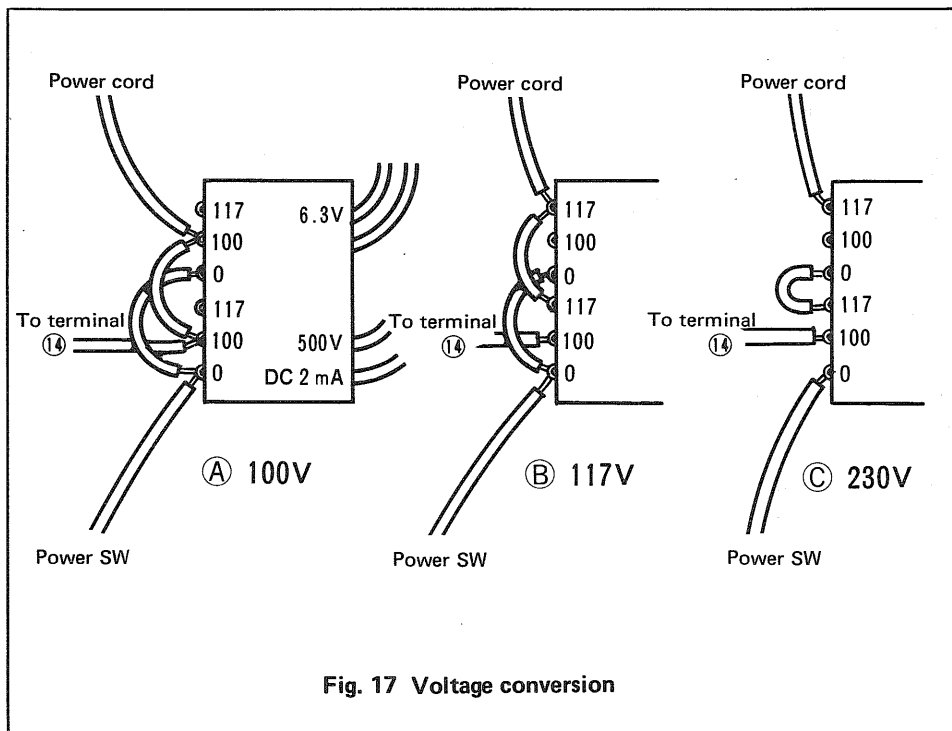

(e) Replacement of Fuse

- 1) Always disconnect power supply before replacing a fuse.
- 2) Remove the cabinet case from the unit.
- 3) Remove the fuse inserted in its holder located on the upper right corner of printed circuit board and insert a new fuse in the fuse holder.
- 4) If the fuse taken out is blown out, trouble shoot the set for brown fuse, repair the trouble and then apply the power to the set.
- 5) For 117 V operation a 0.5 A fuse should be used and for 230 V operation a 0.3 A fuse should be used.

PARTS LIST

26

PARTS LIST OF CO-1303D (Y71-1080-00)

Ref. No.	Parts No.	Description
CAPACITOR		
C1	C91-0511-05	Oil 0.1 μ F 630WV
C2	CC45SL2H150J	Ceramic 15pF \pm 5%
C3	CQ93M1H474K	Mylar 0.47 μ F \pm 10%
C4	CQ93M1H473K	Mylar 0.047 μ F \pm 10%
C5	CQ93M1H392K	Mylar 3900pF \pm 10%
C6, 7	C91-0513-05	Oil 0.47 μ F 630WV
RESISTOR		
R1	RD14BB2E104J	Carbon 100k Ω \pm 5% 1/4W
R2,3	RD14BY2H225J	Carbon 2.2M Ω \pm 5% 1/2W
POTENTIOMETER		
VR1	R03-1019-05	Variable resistor 2k Ω (C)
VR2	R01-0041-05	Variable resistor 500 Ω (B)
VR3	R01-3027-05	Variable resistor 10k Ω (B)
VR4	R03-8019-05	Variable resistor 1M Ω (B)
MISCELLANEOUS		
N1	A01-0189-13	Case
	A10-0475-72	Chassis
	A20-0351-12	Panel
	A20-0994-13	Panel assembly
	A21-0237-14	Dress panel (1)
	A21-0237-04	Dress panel (2)
	A40-0102-13	Bottom plate
	A44-0016-24	Rear Board (2)
	B20-0367-34	Graticule
	B30-0043-15	Neon lamp
	B40-0765-14	Name plate
	B41-0094-04	Caution label (220V - 240V)
	B41-0111-04	Caution label (110V - 120V)
	B50-1445-20	Instruction manual
	D32-0075-04	Switch stopper
	E01-1403-05	CRT socket
	E21-0131-35	Terminal (black)
	E21-0301-05	Terminal board (3P)
	E30-0545-05	AC cord with plug
	F05-3011-05	Fuse (0.3A)
	F05-5013-05	Fuse (0.5A)
	F11-0189-13	CRT shield
	F15-0138-04	Felt
	F15-0163-04	Felt
	F19-0210-04	Patch
	G13-0068-04	Cushion
	G13-0042-04	Cushion
	H01-5818-14	Packing case (individual packing)
	H10-2830-02	Packing material, foamed styrene (Front)
	H10-2831-02	Packing material, foamed styrene (Rear)
	H20-1725-04	Protection cover
	H25-0029-04	Polyethylene bag
	J03-0003-04	Rubber leg
	J20-0265-24	CRT bracket
	J21-0754-34	Terminal bracket
	J21-1204-04	Power transformer bracket
	J21-1431-14	CRT clamping band
	J21-1432-14	CRT clamping band
	J32-0830-04	Boss
	J41-0006-05	Cord bushing
J42-0010-04	Rubber bushing	
J61-0017-15	Snap beaded band	
J61-0053-05	Board support	
J61-0049-05	Cable wrapping band	

Ref. No.	Parts No.	Description
	K01-0058-25	Grip
	K21-0280-14	Knob
	K21-0290-14	Knob
	L01-9516-05	Power transformer
S1	S04-1034-05	Rotary switch
S2	S04-1026-05	Rotary switch
S3~6	S31-2007-05	Slide switch
CRT (cathode ray tube), 75ARB31		
	X65-1120-22	Printed circuit unit
	X67-1040-00	Cord with banana tip

PARTS LIST OF X65-1120-22

Ref. No.	Parts No.	Description
C101	CQ08S1H681J	Polystyrene 680pF ±5%
C102	CQ08S1H680J	Polystyrene 68pF ±5%
C103	C91-0502-05	Ceramic 0.01μF 630V
C104	CK45B1H103K	Ceramic 0.01μF ±10%
C105	CC45SL1H181J	Ceramic 180pF ±5%
C106	CC45SL1H150J	Ceramic 15pF ±5%
C107	CE04BW1H010M	Non-polarized electrolytic 1μF 50WV
C108	CE4W1J010M	Electrolytic 1μF ±20% 63WV
C109	CC45SL1H270J	Ceramic 27pF ±5%
C110	CQ08S1H391J	Polystyrene 390pF ±5%
C111	CE04W1J100M	Electrolytic 10μF ±20% 63WV
C112	CK45B1H681K	Ceramic 680pF ±20%
C113	CC45SL1H331J	Ceramic 330pF ±5%
C114,115	CE02W2E470	Electrolytic 47μF 250WV
C116	CE04W1E221M	Electrolytic 220μF ±20% 25WV
C117	CE04W2A221M	Electrolytic 220μF ±20% 25WV
C118	CE04W1E221M	Electrolytic 220μF ±20% 25WV
C119	CE04W2A221M	Electrolytic 220μF ±20% 100WV
C120	CE04W1V101M	Electrolytic 100μF ±20% 63WV
C121	C91-0571-05	Ceramic 0.01μF ±20% 2KV
C122	CQ93M1H224M	Mylar 0.22μF ±20%
C123	C91-0509-05	Oil 0.1μF ±10% 2KV
C124,125	C91-0506-05	Oil 0.1μF ±10%
C126	C91-0509-05	Oil 0.1μF ±10% 2KV
C127	CE04W1H101M	Electrolytic 100μF ±20% 50WV
C128	CK45B1H103K	Ceramic 0.01μF ±10%
C132	CC45SL1H680J	Ceramic 68p ±5%
TC101.102	C05-0010-15	Ceramic trimmer 10pF
TC103	C05-0029-15	Ceramic trimmer 50pF
RESISTOR		
R101	RN14BK2H9903F	Carbon 990kΩ ±1% 1/2W
R102	RN14BK2H9003F	Carbon 900kΩ ±1% 1/2W
R103	RD14BY2H105J	Carbon 1MΩ ±5% 1/2W
R104	RN14BK2H1004F	Carbon 1MΩ ±1% 1/2W
R105	RN14BK2E1012F	Carbon 10.1kΩ ±1% 1/4W
R106	RN14BK2E1113F	Carbon 111kΩ ±1% 1/4W
R107.108	RD14BB2E102J	Carbon 1kΩ ±5% 1/4W
R109	RD14BB2E562J	Carbon 5.6kΩ ±5% 1/4W
R110.111	RD14BB2E822J	Carbon 8.2kΩ ±5% 1/4W
R112	RD14BB2E101J	Carbon 100Ω ±5% 1/4W
R113.114	RD14BB2E682J	Carbon 6.8kΩ ±5% 1/4W
R115.116	RD14BB2E101J	Carbon 100Ω ±5% 1/4W
R117	RD14BB2E222J	Carbon 2.2kΩ ±5% 1/4W
R118.119	RD14BB2E332J	Carbon 3.3kΩ ±5% 1/4W
R120	RD14BB2E222J	Carbon 2.2kΩ ±5% 1/4W
R121	RD14BB2E430J	Carbon 43Ω ±5% 1/4W
R122.123	RD14BB2E472J	Carbon 4.7kΩ ±5% 1/4W
R124	RD14BB2E391J	Carbon 390Ω ±5% 1/4W
R125.126	RD14BB2E221J	Carbon 220Ω ±5% 1/4W
R127	RD14BB2E681J	Carbon 680Ω ±5% 1/4W
R128	RD14BB2E330J	Carbon 33Ω ±5% 1/4W
R129.130	RS14AB3F392J	Metal film 3.9kΩ ±5% 3W
R131	RD14BB2E124J	Carbon 120kΩ ±5% 1/4W
R132.133	RD14BB2E273J	Carbon 27kΩ ±5% 1/4W
R134	RD14BB2E472J	Carbon 4.7kΩ ±5% 1/4W
R135	RD14BB2E124J	Carbon 120kΩ ±5% 1/4W
R136	RD14BB2E272J	Carbon 2.7kΩ ±5% 1/4W
R137	RD14BB2E152J	Carbon 1.5kΩ ±5% 1/4W
R138	RD14BB2E682J	Carbon 6.8kΩ ±5% 1/4W
R139	RD14BB2E332J	Carbon 3.3kΩ ±5% 1/4W
R140	RD14BB2E183J	Carbon 18kΩ ±5% 1/4W
R141	RD14BB2E683J	Carbon 68kΩ ±5% 1/4W
R142	RD14BB2E123J	Carbon 12kΩ ±5% 1/4W

Ref. No.	Parts No.	Description
R143	RD14BB2E103J	Carbon 10kΩ ±5% 1/4W
R144.145	RD14BB2E123J	Carbon 12kΩ ±5% 1/4W
R146.147	RD14BB2E392J	Carbon 3.9kΩ ±5% 1/4W
R148	RD14BB2E331J	Carbon 330Ω ±5% 1/4W
R149.150	RS14AB3D223J	Metal film 22kΩ ±5% 2W
R151	RD14BB2E333J	Carbon 33kΩ ±5% 1/4W
R152	RD14BB2E124J	Carbon 120kΩ ±5% 1/4W
R153	RS14AB3F821J	Metal film 820Ω ±5% 3W
R154	RN14AB3D681J	Metal film 680Ω ±5% 2W
R155	RS14AB3F471J	Metal film 470Ω ±5% 3W
R156	RD14BY2H102J	Carbon 1kΩ ±5% 1/2W
R157	RD14BB2E104J	Carbon 100kΩ ±5% 1/4W
R158	RD14BY2H473J	Carbon 47kΩ ±5% 1/2W
R159~161	RD14BY2H105J	Carbon 1MΩ ±5% 1/2W
R162	RD14BY2H274J	Carbon 270kΩ ±5% 1/2W
R163	RD14BY2H564J	Carbon 560kΩ ±5% 1/2W
R164	RD14BY2H225J	Carbon 2.2MΩ ±5% 1/2W
R165	RD14BY2H154J	Carbon 150kΩ ±5% 1/2W
R166	RD14BY2H184J	Carbon 180kΩ ±5% 1/2W
R167	RD14BY2H104J	Carbon 100kΩ ±5% 1/2W
R168.169	RD14BB2E101J	Carbon 100Ω ±5% 1/4W
R178	RD14BB2E184J	Carbon 180kΩ ±5% 1/4W
POTENTIOMETER		
VR101	R12-1004-05	Semi-fixed resistor 4.7kΩ (B)
VR102	R12-1002-05	Semi-fixed resistor 1kΩ (B)
VR103.104	R12-8008-05	Semi-fixed resistor 1MΩ (B)
SEMI-CONDUCTOR		
Q101~103		Field effect transistor 2SK30A-0 (IDSS)
Q104~109		Transistor 2SC535-B
Q110.111		Transistor 2SC1507
Q112.113		Transistor 2SC458-C
Q114		Field effect transistor 2SK30A-0 (IDSS)
Q115.116		Transistor 2SC1507
D101		Diode 1N60
D102.103		Diode V08J
D104		Diode S1VB60
D105.106		Zener diode MTZ16JA
D107.108		High voltage diode SHV-Z3
D109		Zener diode MTZ2.2JB
D110		Diode 1S1555
MISCELLANEOUS		
	E23-0046-04	Terminal
	F02-0028-04	
	F05-3011-05	Fuse
	F11-0026-24	Shield case
	J13-0020-05	Fuse holder
	J25-1319-23	Printed circuit board

10. P.C. BOARD

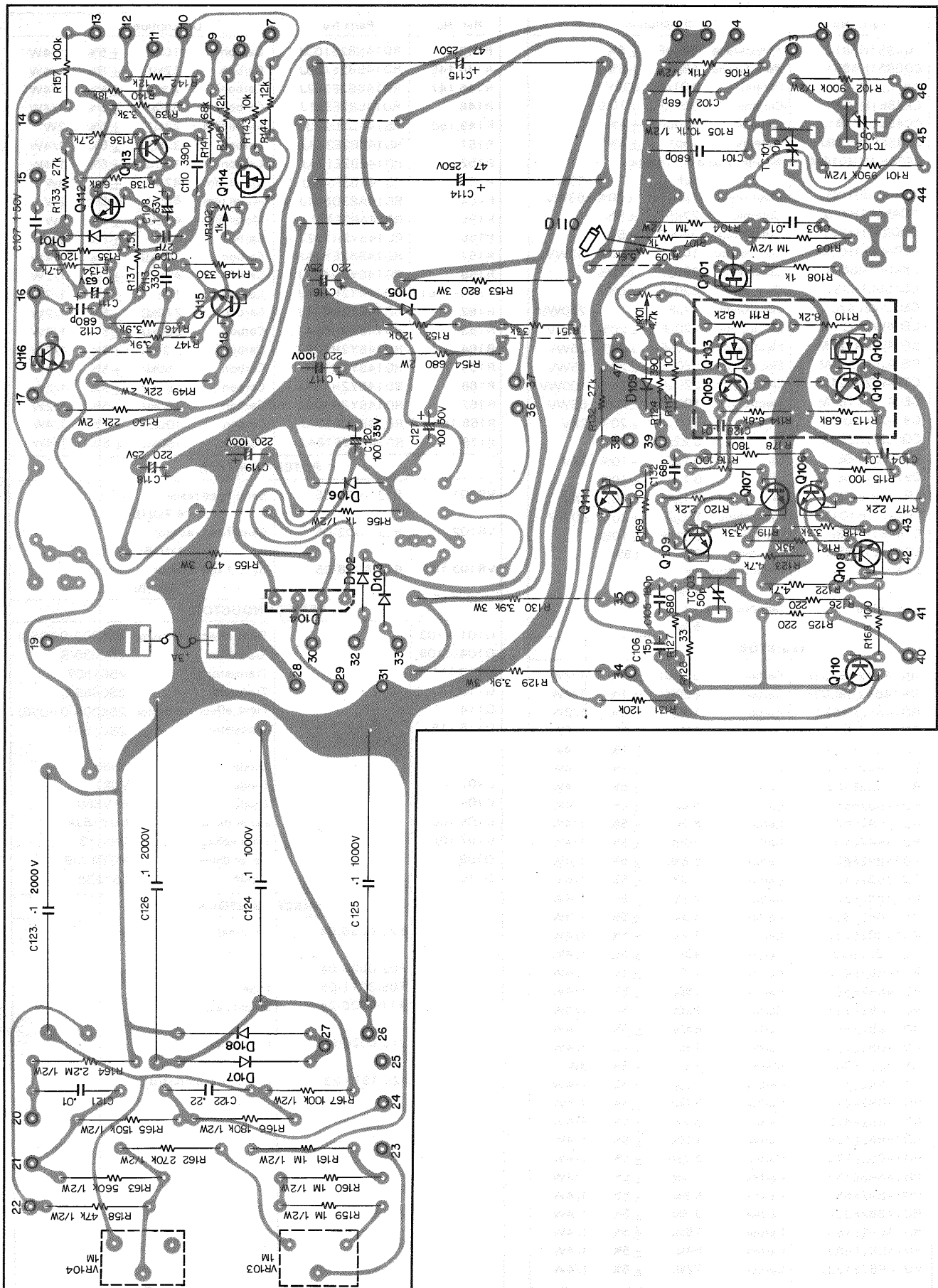

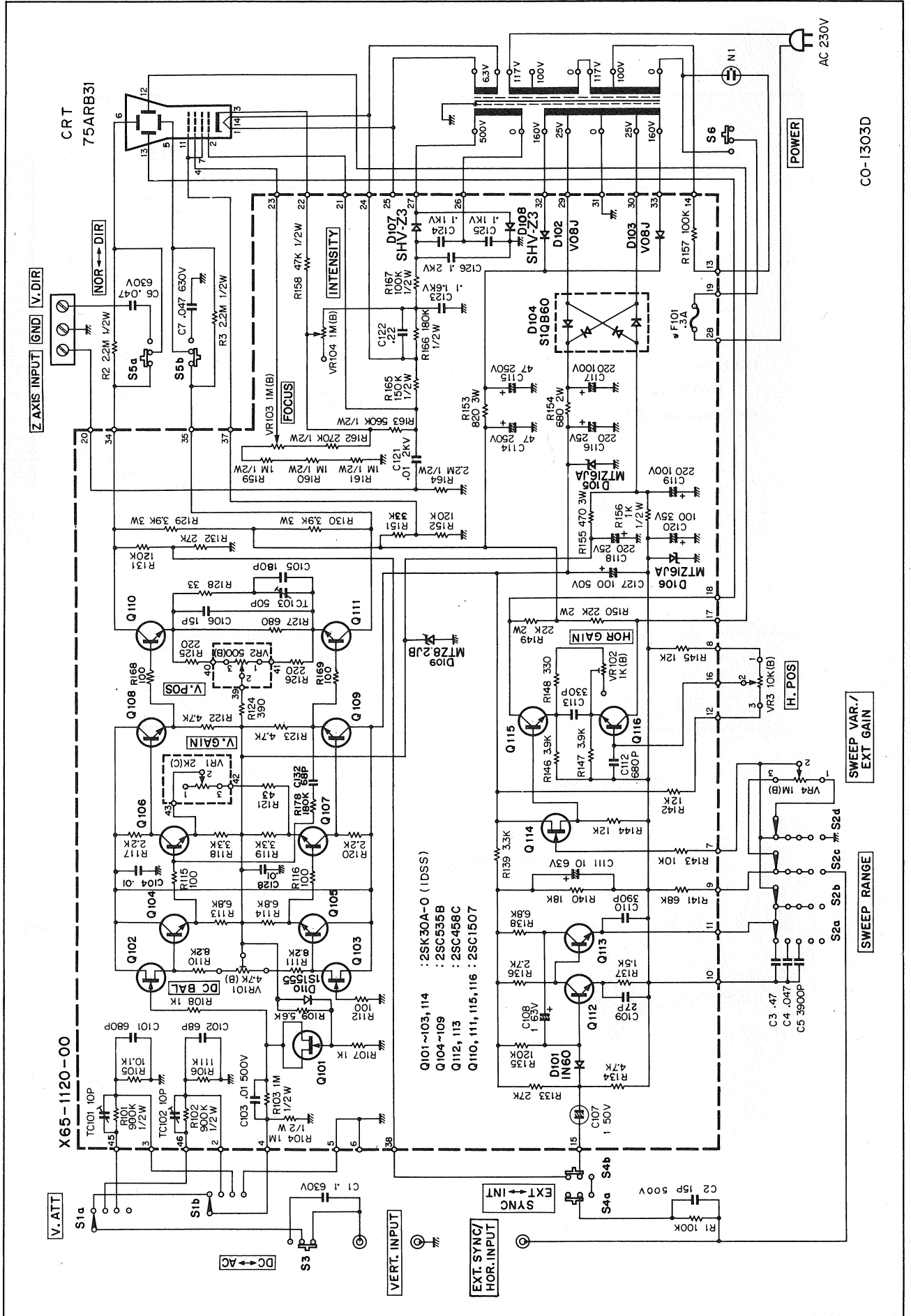

12. BLOCK DIAGRAM & EXTERNAL VIEW

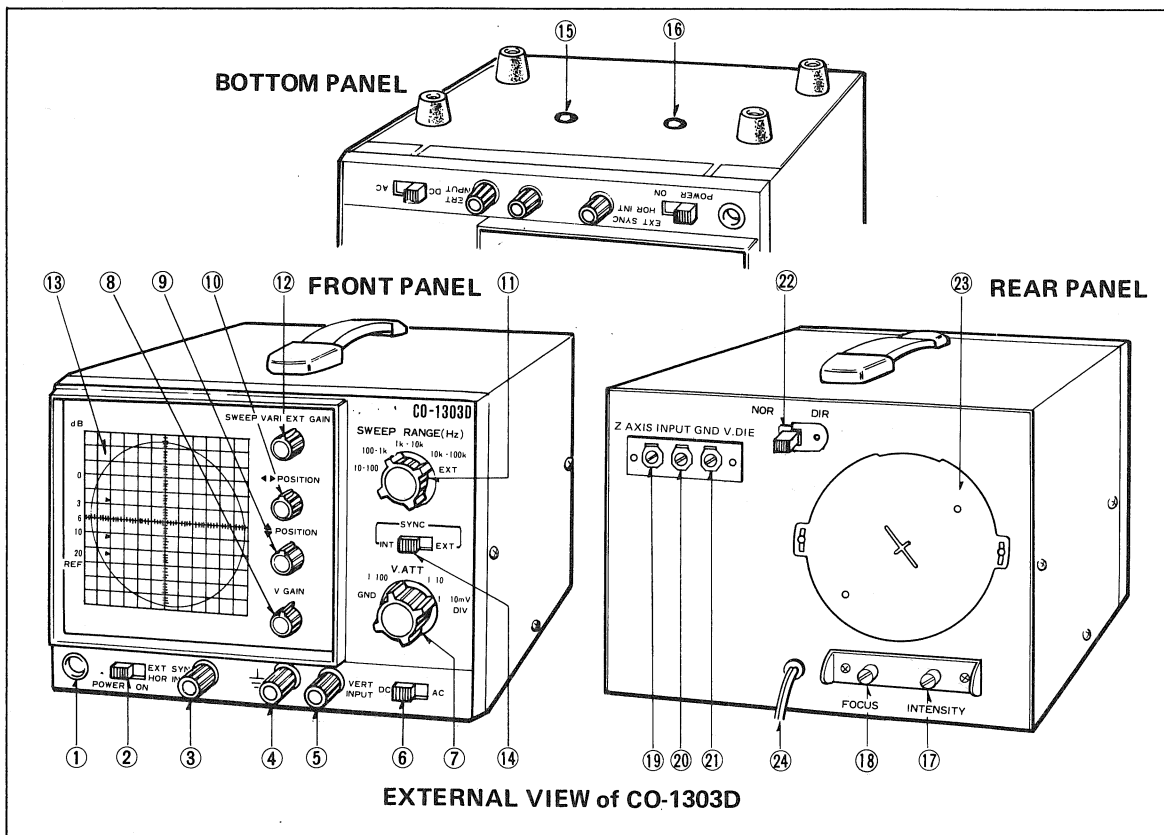
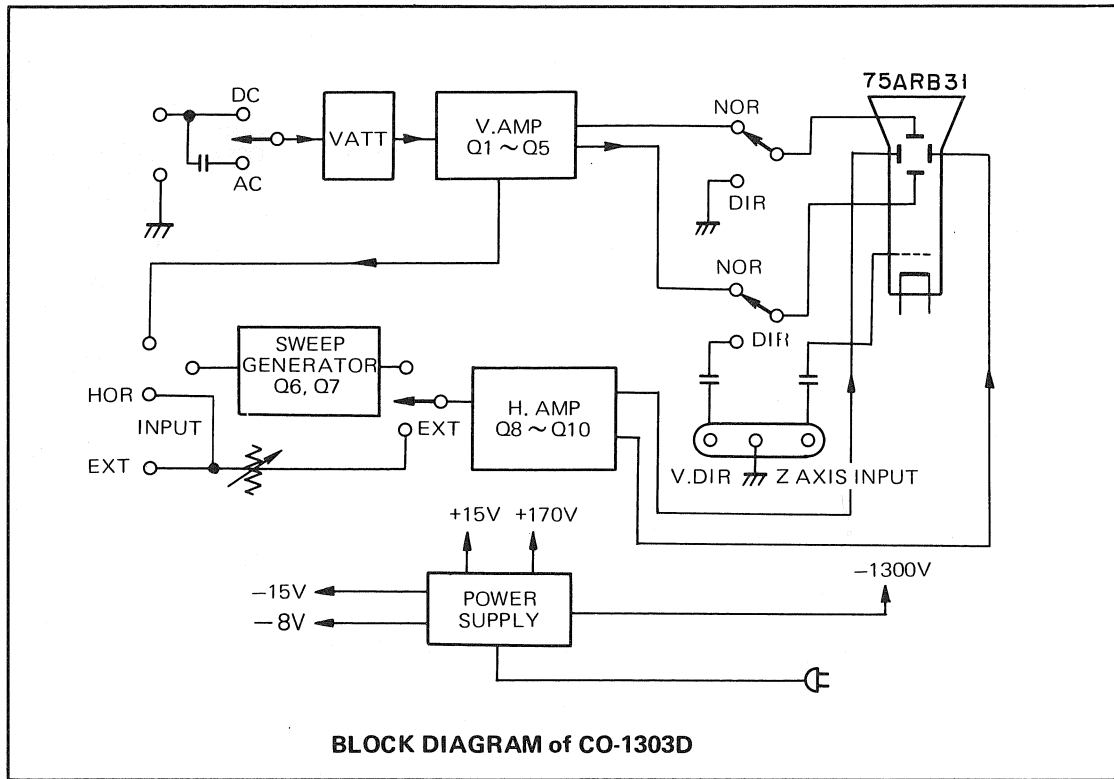

A product of
KENWOOD CORPORATION
17-5, 2-chome, Shibuya, Shibuya-ku, Tokyo 150, Japan
