





# DIGITAL ADAPTOR KIT DK-520

## INSTALLATION MANUAL

The KENWOOD DK-520 Digital Adaptor Kit is designed for adapting the DG-5 digital counter to the TS-520. The DK-520 consists mainly of a power supply with connectors to supply the signals to the DG-5, and a buffer unit for the HET output signals.

### PARTS SUPPLIED

1. Power supply unit	1
2. Buffer unit	1
3. Power cable	1
4. Fuse, 2A	1
5. Converter cover	1
6. Mounting stud	1
7. Hardware:	
a. panhead screw 4x6 mm long	1
b. self tapping screws, 3x6 mm long	2
c. lock washer	1
d. flat washer	1

### INSTALLATION

First, remove the top and bottom covers of the TS-520. When removing the top cover, remember to unplug the speaker lead before setting the top aside. Install the DK-520 as follows: (Ref. to fig. 1 thru. 6)

1. Remove the wing nut and washer from the ground lug on the rear panel of the TS-520, and install the mounting stud on the ground lug.
2. Install the DK-520 power supply unit on the mounting stud as shown in fig. 1. Use the panhead screw, lock washer, and flat washer to hold the power supply unit in place.
3. Remove the slotted cover from the DC-DC converter.
4. Install the new slotted cover with the notch at the bottom.
5. Insert the wiring harness through the notch and feed it over the power transformer.
6. Locate the DC-DC converter terminal board (See fig. 2).
7. Solder one of the two white solid wires from the power supply unit to the terminal with the red lead on it.
8. Solder the other white solid wire to the terminal with the orange lead on it.
9. Solder the black solid wire to the chassis ground lug (See fig. 2)
10. Locate the coaxial lead with the red band.
11. Solder the center conductor of this cable to pin 1 of the remote VFO socket. (See fig. 2.)
12. Solder the shield of this cable to pin 2.

13. Locate the cable harness that runs parallel to the front of the RF unit.
14. Gently move this harness aside to reveal the two mounting holes for the buffer unit.
15. Install the buffer unit with the two self tapping screws.
16. Solder the yellow solid wire from the buffer unit to TP-3 on the RF unit.
17. Locate the yellow solid wire with the cap and install it over the case of FET Q8 (3sk22).
18. Solder the black solid wire from the buffer unit to the GND pin on the RF unit.
19. Solder the red solid wire from the buffer unit to the 14 pin of the FIX CH. AVR Unit.
20. Locate the coaxial lead with the blue band.
21. Solder the center conductor of this cable to the OUT terminal of the buffer unit.
22. Solder the shield of this cable to the GND terminal.
23. Feed the remaining coaxial cable, red solid wire, and white/black solid wire through the chassis as shown in Fig. 2.
24. Solder the red solid wire to pin 5 of the power connector as shown in Fig. 3.
25. Solder the white/black solid wire to the chassis ground lug.
26. Solder the center conductor of the coaxial cable to the OUT terminal of the CAR unit.
27. Solder the shield to the GND terminal.
28. Solder a jumper on the WWV/JJY switch as shown in fig. 4. Do not jumper the orange and purple wire.

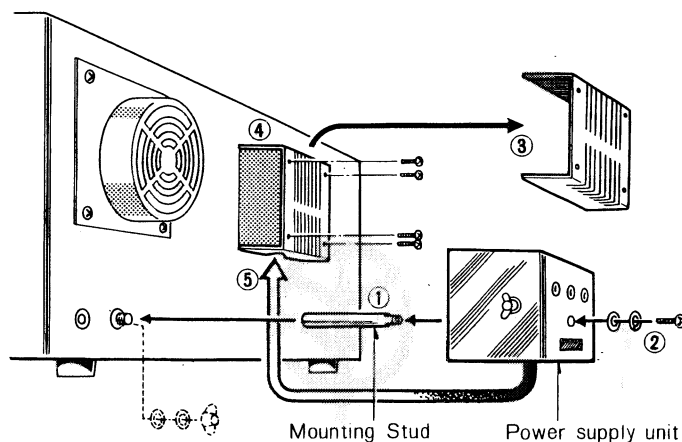
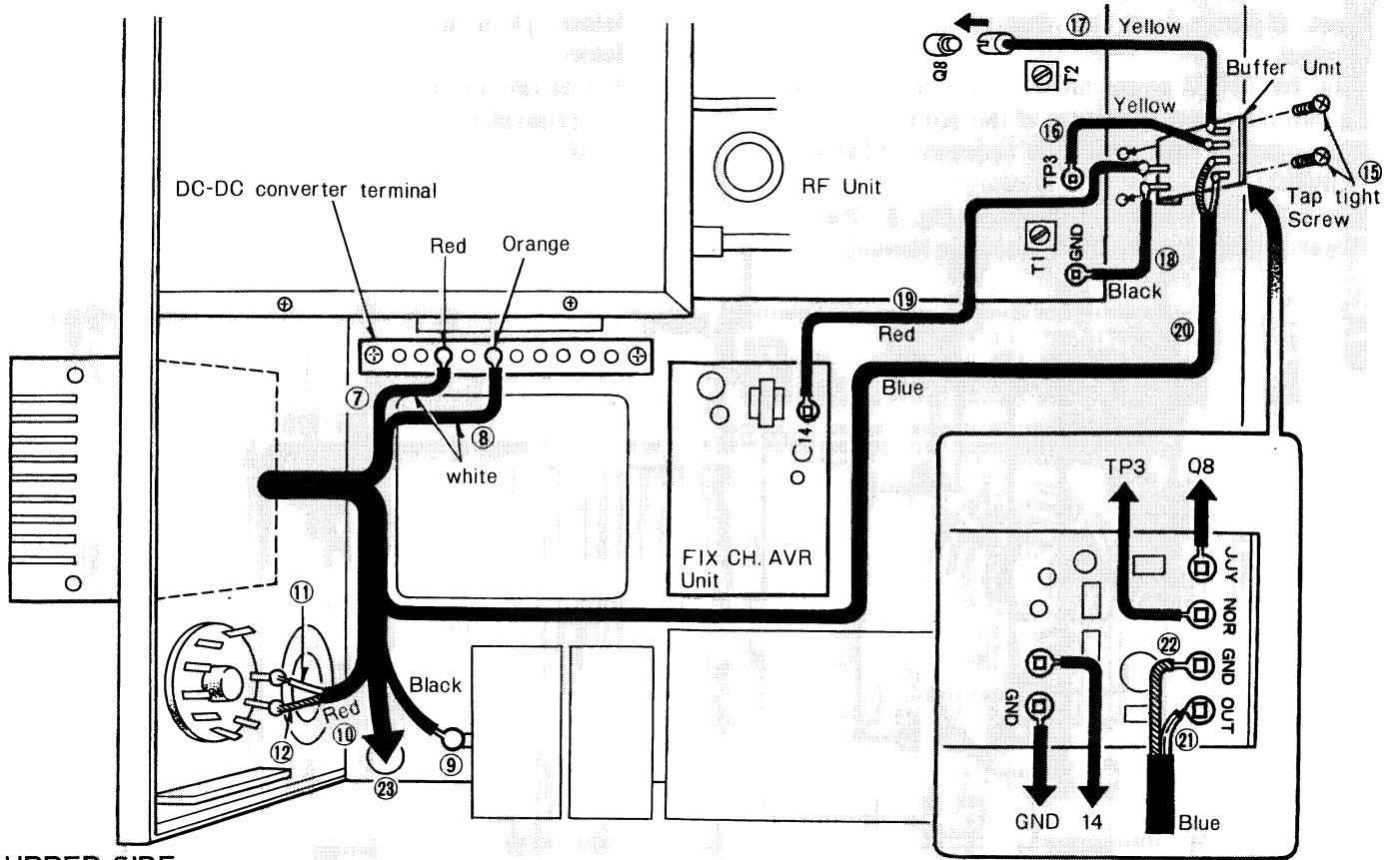

Fig 1

⑥ ⑬ ⑭



UPPER SIDE

Fig. 2

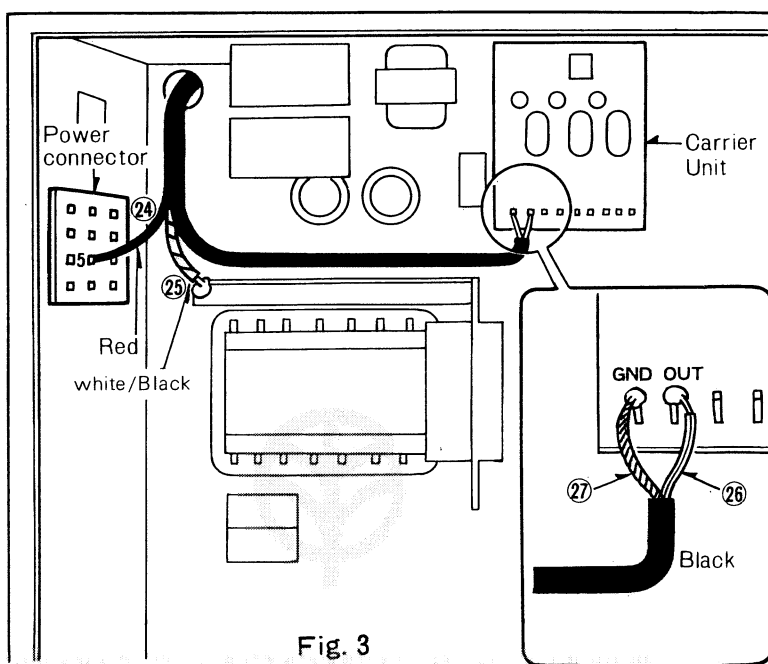

Fig. 3

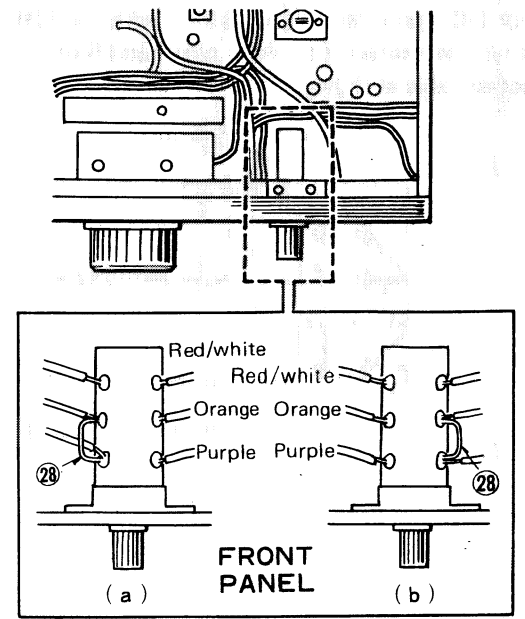
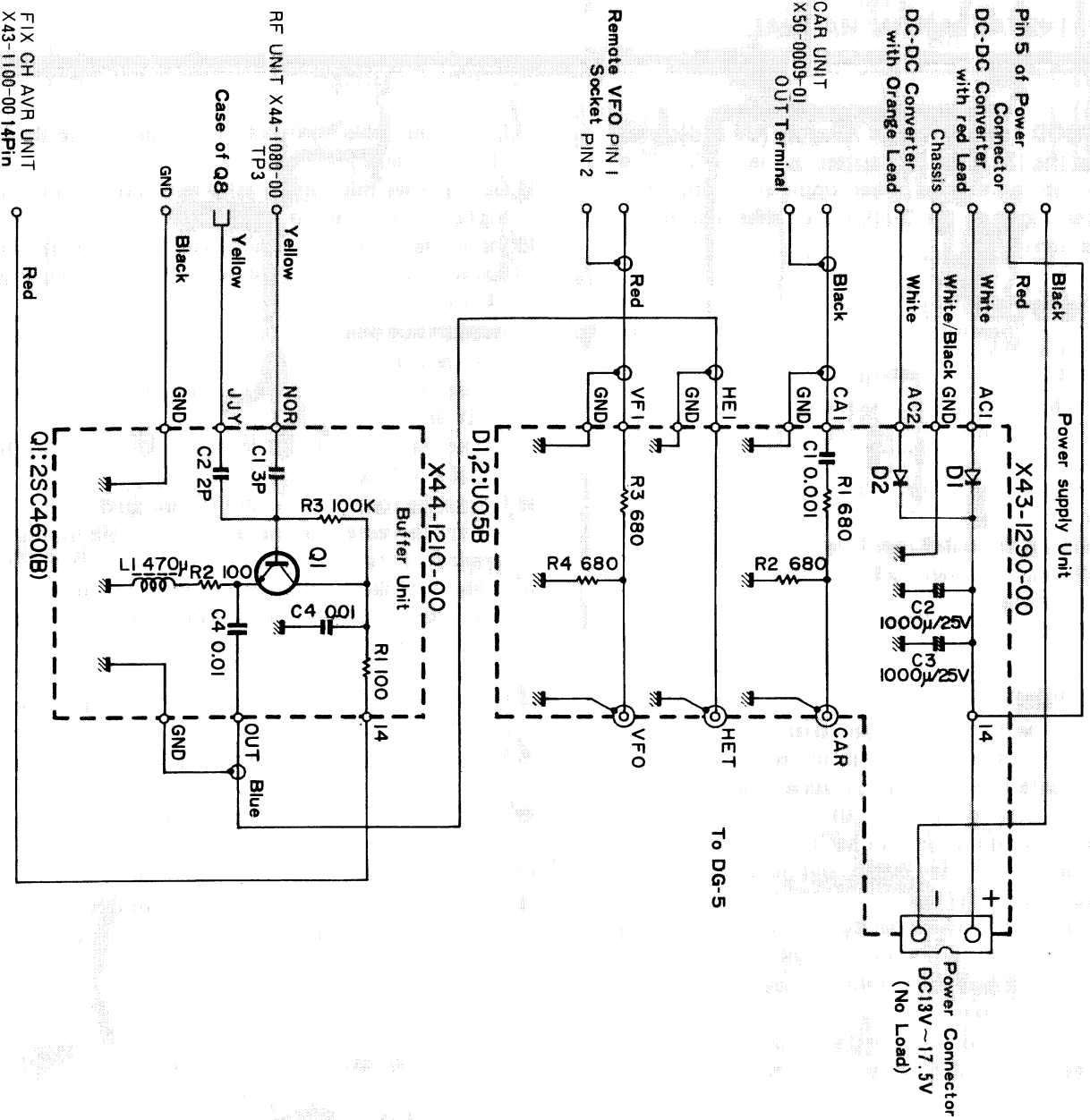

Fig 4 WWV Switch

# SCHEMATIC DIAGRAM

To TS-520

Circuits and specifications are subject to change for improvement.



FIX CH AVR UNIT  
X43-1100-00 14Pin

DK-520

## HOW TO CHECK DK-520 OPERATION

1. Check all wiring to be sure that all leads are correctly installed.
2. Turn the TS-520 power on and measure the voltage at the two pin power connector of the power supply unit. The output voltage should be between 13.0VDC and 17.5VDC.
3. Install the DG-5 cables as shown in Fig. 5. Check for proper frequency as per DG-5 Operating Manual.

## TOOLS REQUIRED

1. Soldering iron (not to exceed 45 watts).
2. Solder
3. Phillips screwdriver
4. Long nose pliers
5. VOM

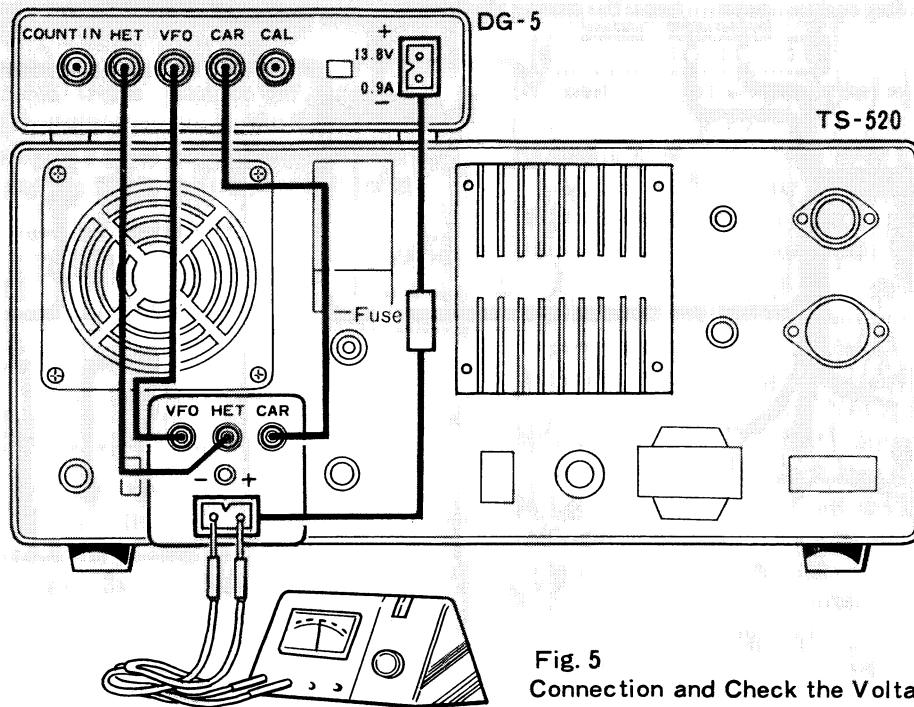
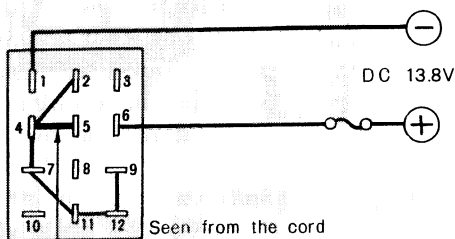

Fig. 5  
Connection and Check the Voltage

## DC OPERATION

For DC operation of the TS-520 (with DK-520) and DG-5, it will be necessary to short pins 4 and 5 of the TS-520 DC power cable as shown in fig. 6.



Short the No.4pin and No.5pin

Fig. 6

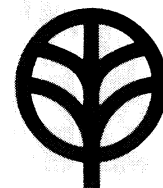

A product of  
**TRIO-KENWOOD CORP.**

6-17, 3-chome, Aobadai, Meguro-ku, Tokyo 153, Japan