

## CONTENTS

CIRCUIT DESCRIPTION .....	2
DESCRIPTION OF COMPONENTS .....	17
PARTS LIST .....	19
EXPLODED VIEW .....	29
PACKING .....	30
ADJUSTMENT .....	31
PC BOARD VIEWS	
DSP UNIT (X53-3360-00) .....	33
SCHEMATIC DIAGRAM .....	38
TERMINAL FUNCTION .....	44
SPECIFICATIONS .....	BACK COVER

# DSP-100

## CIRCUIT DESCRIPTION

### Overview of the DSP-100

#### 1. Functions

The DSP-100 performs digital signal processing for the following:

- SSB modulation
- CW
- AM
- FSK modulation
- Carrier generation during frequency modulation
- PSN detection and audio-frequency low-pass filtering
- DSB detection and audio-frequency low-pass filtering

#### 2. DSP-100 Features

##### • Modulation method

The DSP-100 has the same performance as the DSP-10, and carries out SSB modulation by the PSN method, CW waveform shaping with a ROM filter, and waveform shaping with a FIR filter to speed up FSK. The DSP-100 has Gaussian characteristics to reduce CW and FSK distortion.

##### • Demodulation method

The signals on both sides of the carrier point are detected for SSB, CW, and FSK demodulation by the conventional product detection method. On the other hand, the PSN detection method detects only one side band by controlling the phase, and so achieves sharp and superior side-band suppression characteristics and low group delay distortion, like a very sharp filter.

#### 3. Configuration

Figure 1 is a block diagram of the DSP. The DSP consists of a digital unit, which controls operations and carries out digital signal processing; an analog unit, which processes analog signals, outputs them to the digital unit, and converts the signals from the digital unit to analog signals; a DDS unit, which generates a zero input limit cycle suppression signal, and a PLL unit, which generates clocks for executing centralized management with external reference signals and for carrying out digital signal processing with an accurate sampling frequency.

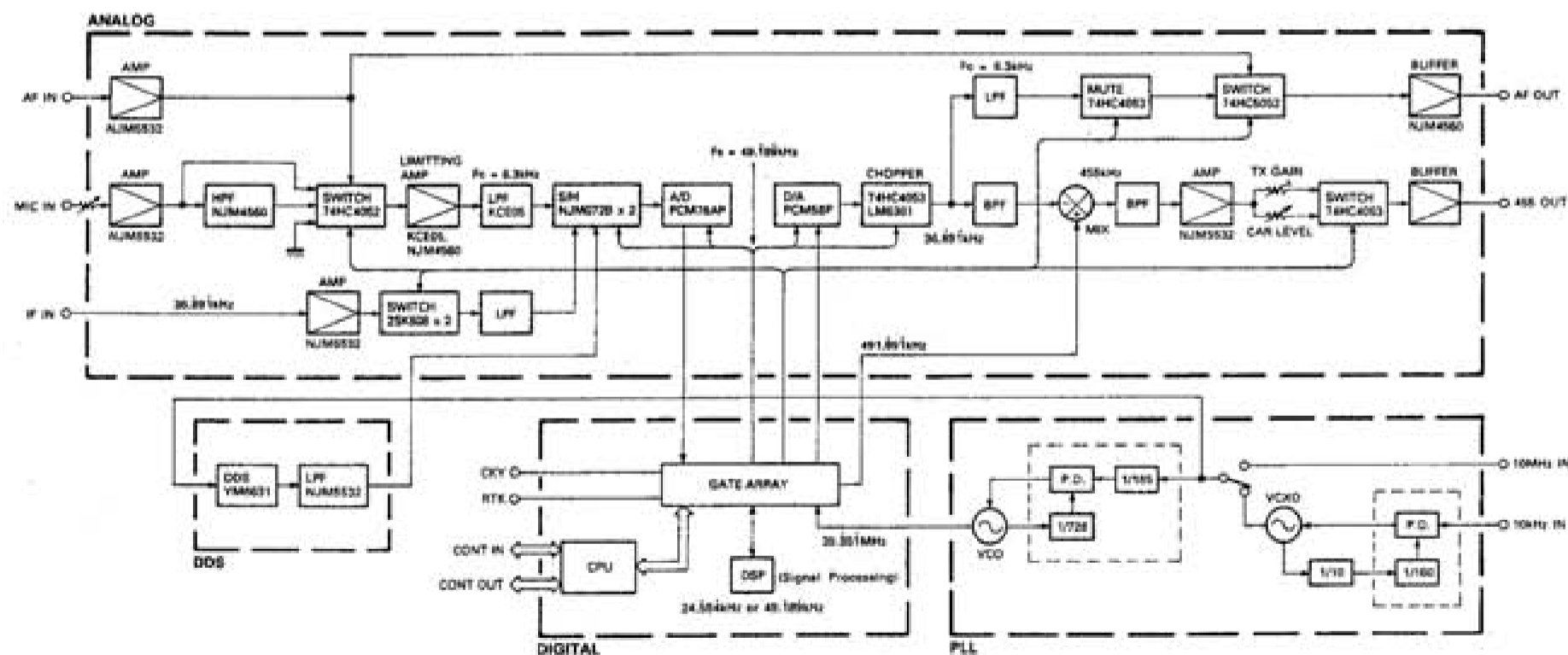

Fig. 1 DSP-100 block diagram

## CIRCUIT DESCRIPTION

### What is DSP?

#### 1. Signal processing

Amplification, filtering, and modulation/demodulation of signals sampled over certain time intervals with digital adders, subtractors, and data registers is called digital signal processing, in contrast to analog signal processing, which carries out amplification, filtering, and modulation/demodulation of signals with passive components, such as resistors, capacitors, and coils, and active components, such as transistors and ICs.

Since signals and coefficients are digitized in digital signal processing, variations of parts and deterioration of performance with time, which are likely to occur in analog signal processing, can be eliminated. Signal processing that is impossible with analog signal processing can be done easily with digital signal processing. A typical recent example is the FIR filter used for signal analysis by FET and digital audio equipment. A phase linear filter, such as the FIR filter, can be implemented only approximately with an analog filter, but can be implemented easily by digital signal processing.

Analog signal processing is completely different from digital signal processing in the filter structure, for example, as shown in Figure 2, but the analog characteristics can be approximated by characteristics conversion methods called Z conversion and bilinear conversion with the IIR filter shown in Figure 2b. Design is possible with a digital filter using the design techniques for analog filters, and there is little difference in the basic characteristics.

#### (a) Analog filter (active filter)

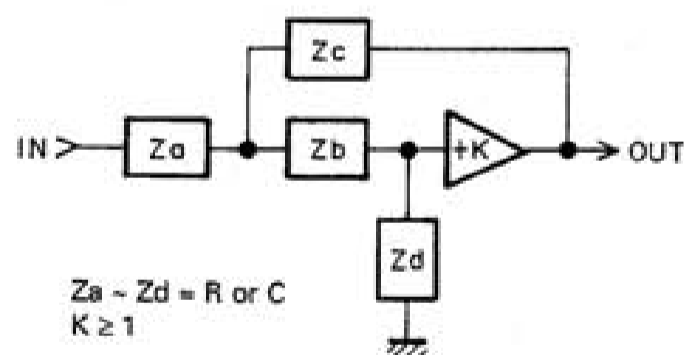

#### (b) Digital filter

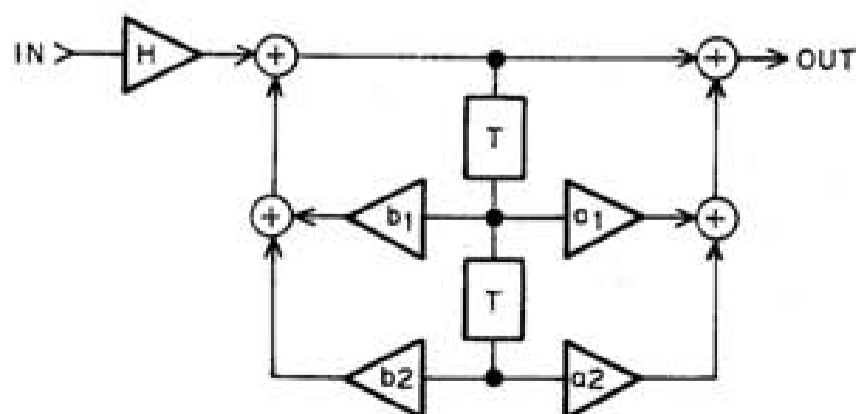

H : Scaling coefficients  
 $a_1, a_2, b_1, b_2$  : Coefficients  
 T : Register

$$H(Z) = H \frac{1 + a_1 Z^{-1} + a_2 Z^{-2}}{1 - b_1 Z^{-1} - b_2 Z^{-2}}$$

Fig. 2 Secondary filter

#### 2. Hardware for implementing digital signal processing

Since the circuits for analog signal processing must consist of many parts, they cannot be replaced with LSIs, but the circuits for digital signal processing may contain LSIs, and so their size can be reduced and reliability improved.

One of the features of digital signal processing is that actual digital signal processing can be implemented by software as well as by hardware. So, many functions and characteristics can be implemented by one piece of hardware.

A processor with a high execution speed and a high calculation capability is required to perform digital signal processing by software. A DSP (digital signal processor) has been developed for this purpose.

#### 3. Characteristics of digital signal processing

##### • Elements that determine characteristics

In digital signal processing, the functions are determined by a combination of operational elements and registers, or by the software that implements the algorithm, and the characteristics are determined by the coefficients register value used for an operation that corresponds to the LCR constant for analog signal processing and the sampling frequency.

##### • Coefficients

If a coefficient error occurs because of quantization of the coefficients register and the bit length is insufficient, the desired characteristics cannot be obtained. Figure 3a gives an example of a change of filter characteristics through the quantization of the coefficients register.

##### • Noise

Digitizing signals produces quantization noise, and an operation error due to the quantization of operational elements causes rounding noise. If the bit length is insufficient, the desired signal-to-noise ratio could be obtained due to noise. Figure 3b shows the frequency characteristics of rounding noise. A return type filter called a IIR filter may output noise called a zero input limit cycle even though there is no input. Since the noise is caused by the quantization of the return loop, it does not occur if there is an input signal. It occurs because the operated value in the return loop does not converge to 0 if there is no signal input. Figure 3c shows the input/output characteristics at this time.

## CIRCUIT DESCRIPTION

FIR of degree 84

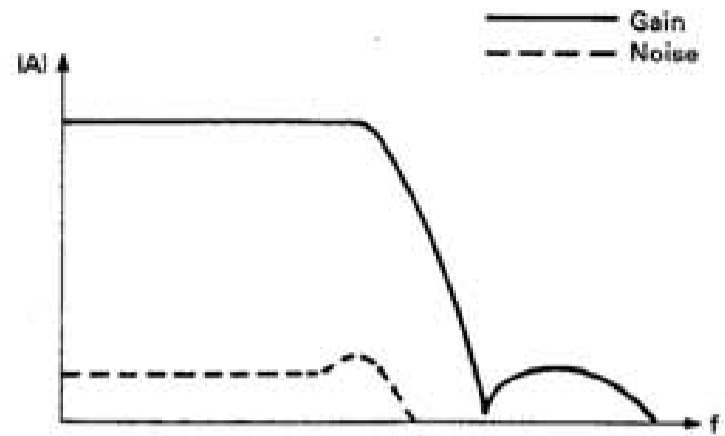
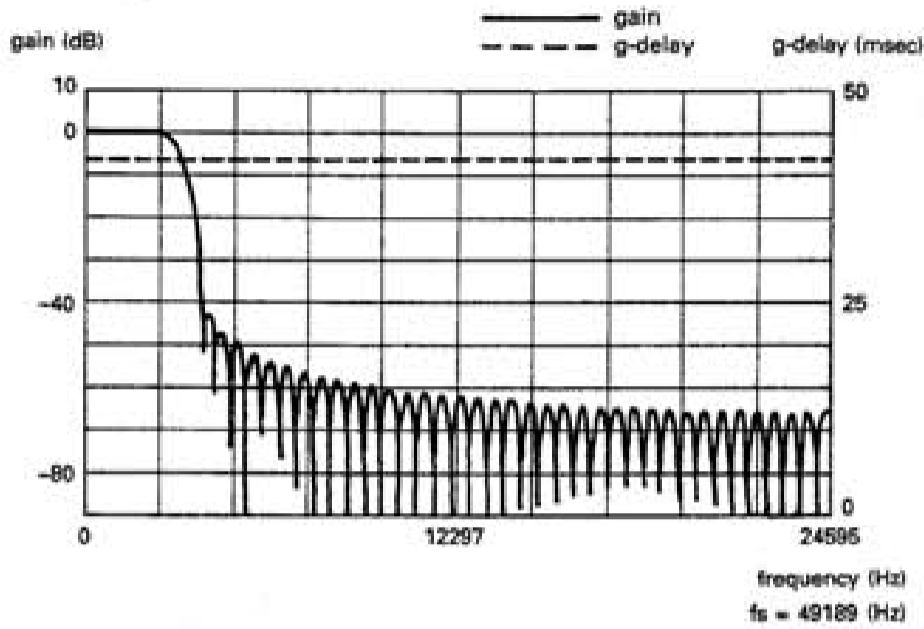

Fig. 3-b IIR filter noise characteristics

FIR of degree 84 (16-bit quantization)

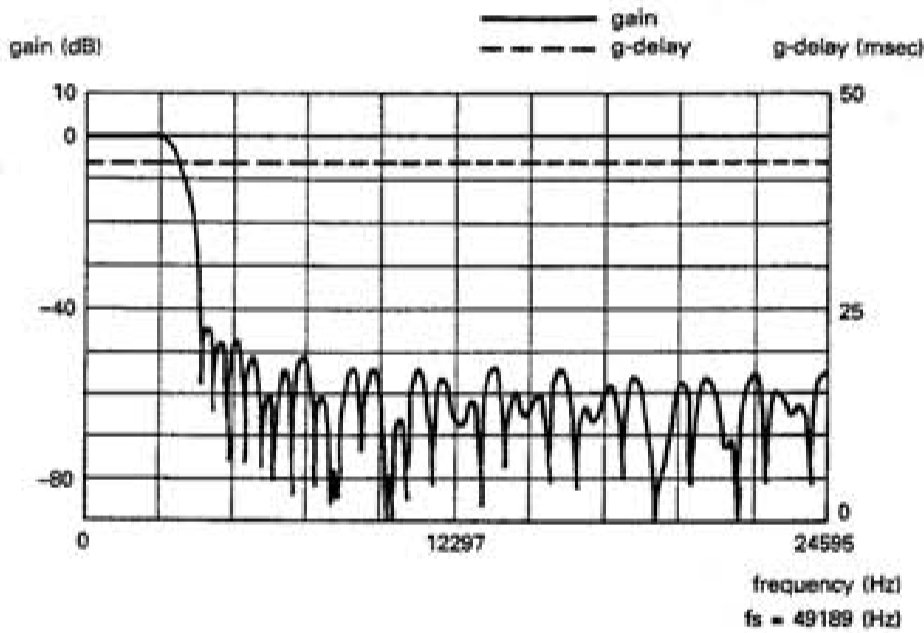

Fig. 3-a FIR filter factor quantization

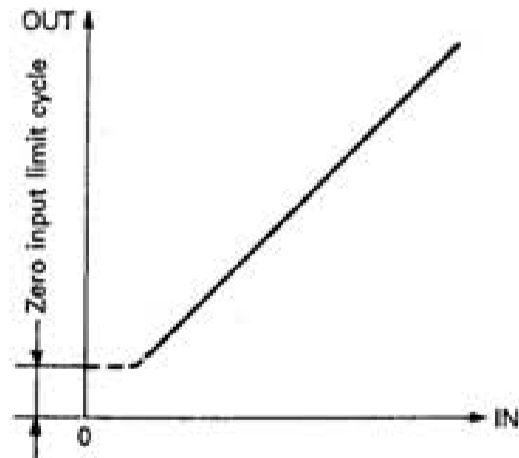
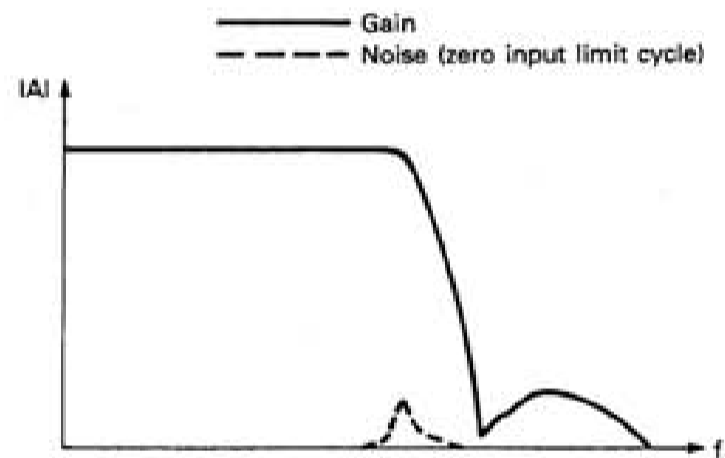

Fig. 3-c Zero input limit cycle

## CIRCUIT DESCRIPTION

### DSP Circuit Description

#### 1. Flow of signals

The flow of signals in each of the modes is described below.

##### 1-1. Modulation

##### • Flow of signals to modulation in SSB/AM mode

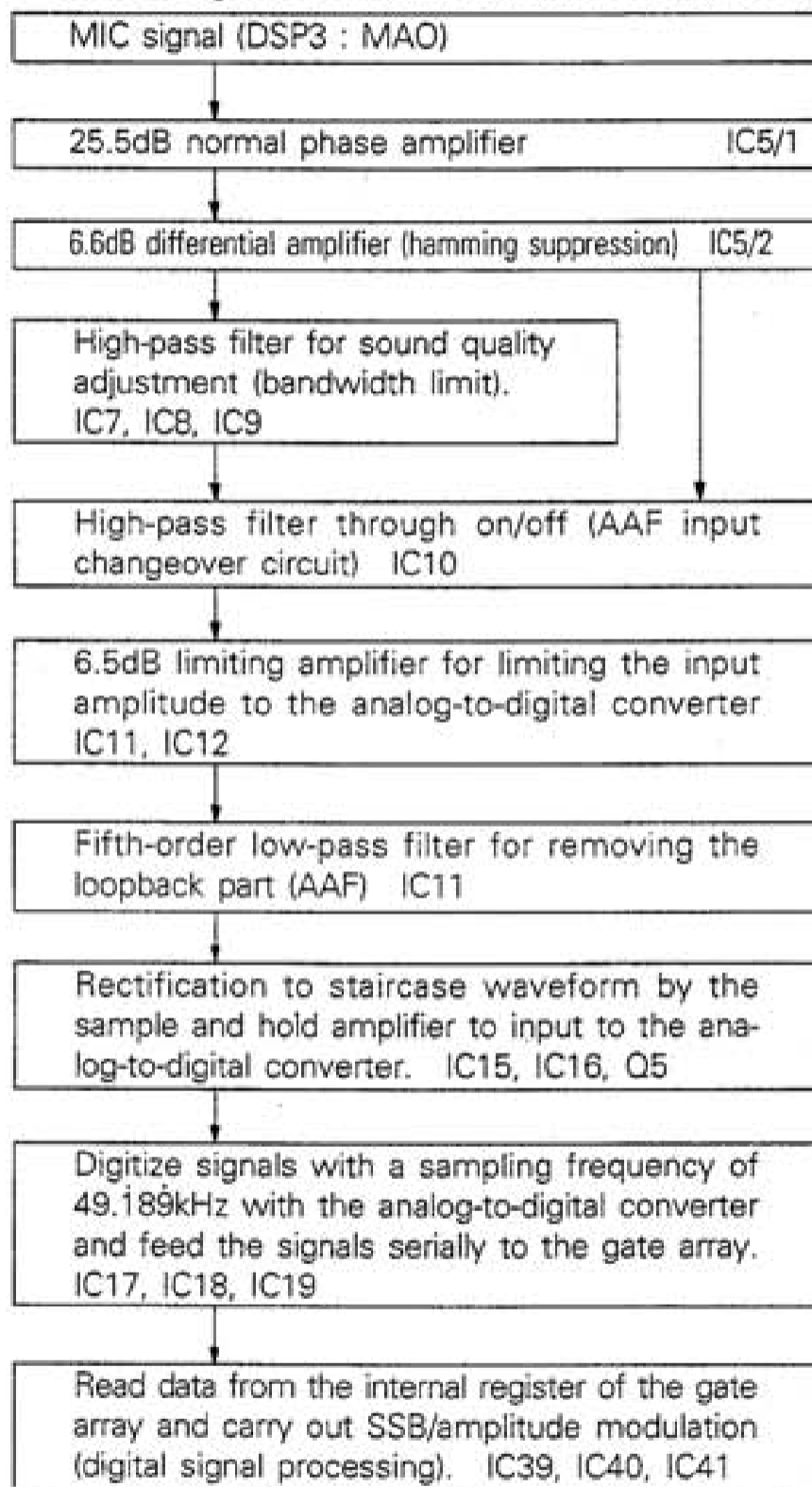

##### • Flow of signals to modulation in CW mode

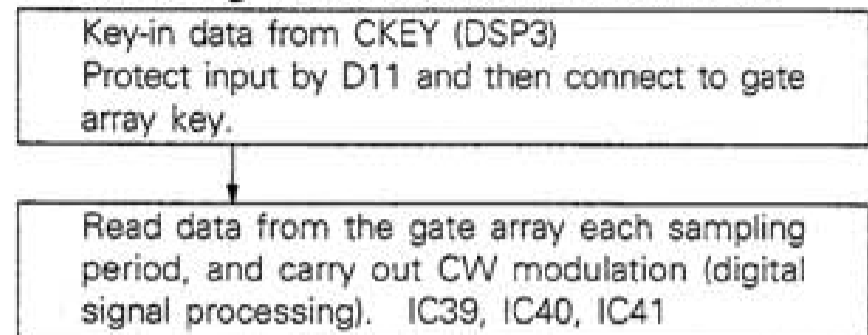

##### • Flow of signals to modulation in FSK mode

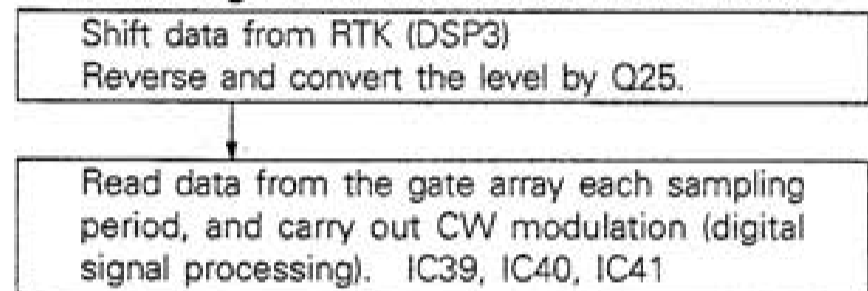

##### • Flow of signals after D/A output in each modulation mode

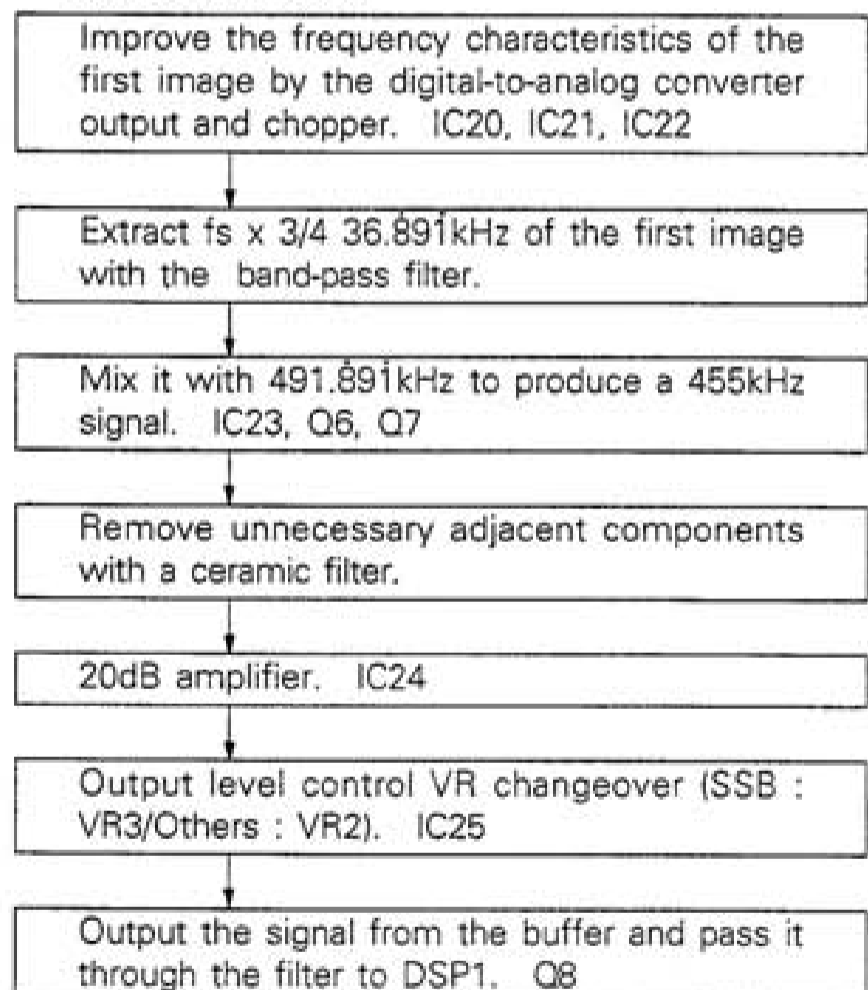

## CIRCUIT DESCRIPTION

### 1-2. Flow of Signals for Detection

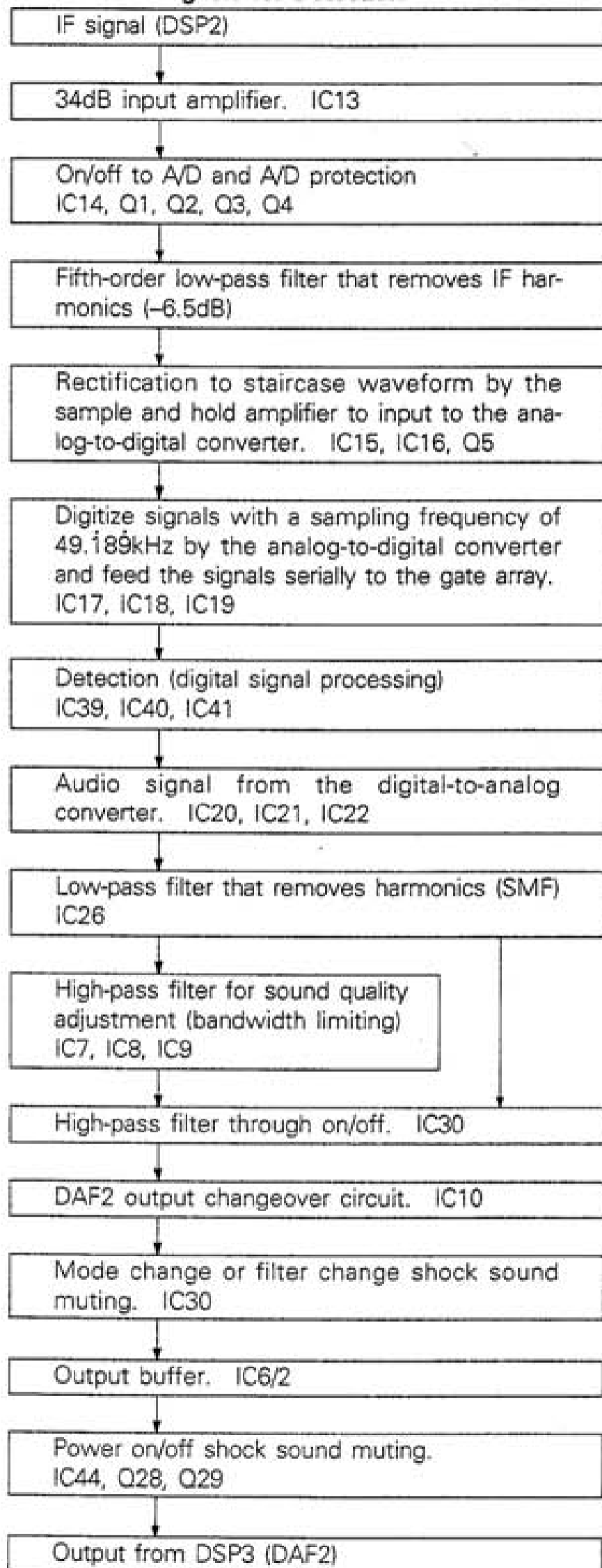

### 2. Description of Units

#### 2-1. PLL Unit

The PLL circuit has a fixed output frequency to obtain the reference for each clock used for the DSP. Reference signals of 10MHz or 10kHz are input.

##### • 10kHz input

If S7 and S8 are set to the 10kHz side, a 10kHz signal is input from the REF terminal of the DSP3. The 10kHz signal is amplified by Q15 and sent to IC32. The signal is then compared with 1/10 the VCXO output by IC33, then compared with 1/100 the VCXO output by IC32, and the PLL is locked at 10MHz. The locked 10MHz signal is buffered by Q16 and supplied to the DDS and 39.351MHz PLL.

The 10MHz signal to the 39.351MHz is input to IC35 and divided by 185 to produce a 54.054kHz comparison signal. It is compared with 1/728 the VCO output in IC35, and the PLL is locked at 39.351MHz. A 728/185-times signal is supplied to the digital unit as a DSP reference signal.

##### • 10MHz input

If a 10MHz signal is input, S7 and S8 are set to the 10MHz side, and the output buffered by Q14 is directed to the 39.351MHz PLL and DDS. The 10MHz signal supplied to the 39.351MHz PLL locks this PLL at 39.351MHz in the same way as for the 10kHz signal.

#### 2-2. Digital Unit

The digital unit consists of a control microprocessor (647180X0FS6JBR2), a digital signal processor (DSP; TMS320E15J), and associated peripheral circuits.

##### 1) Microprocessor

The microprocessor transmits commands to, and receives them from, the transceiver through the personal computer interface, reads switches on the front and rear panels, sets the DSP mode by determining transmission or reception status from the TXB line, transfers data to the DSP, PLL, and DDS, and controls the analog unit. Clock signals of 9.216MHz are used.

##### • Personal computer interface

The transceiver is connected to the data input through CONT IN. If it is necessary to transfer data for personal computer control and cloning to the transceiver, relay equipment can be connected to CONT OUT to relay all data except commands to the DSP. IC38 is a reversing buffer for the personal computer interface. IC43 is a reversing circuit for inputting clock-synchronizing serial signals through the personal computer interface. The signals are reversed if SMD0 is low.

## CIRCUIT DESCRIPTION

- **Switch input**

The front panel switches output ST0, ST1, and ST2 strobe signals to S1, S2, and S3/S4/S5, and read the returned RT0 to RT6 to determine the switch status. Ten DIP switches on the rear panel are directly connected to the microprocessor.

- **TXB, DBC**

The remote transmission/reception mode is set by the transceiver, and the microprocessor changes between transmission and reception according to the TXB level. For quick change for full break-in in CW mode, the DSP checks TXB and changes between modulation and demodulation. The DBC is a DSP connect signal that goes low regardless of the TX/RX on/off switch while the DSP is operating. When the PLL is unlocked, the signal goes high to stop DSP operation.

### 2) DSP

The DSP is a high-speed processor for digital signal processing that uses a 25MHz crystal for internal clocking and operates with 6.25MHz (160ns) clocks (1/4 the 25MHz signal). Most instructions, such as addition (16 + 16 bits) and multiplication (32 + 32 bits), are carried out in one machine cycle. The DSP contains a 4-Kword EPROM and a 256-word RAM.

It interfaces with the analog-to-digital and digital-to-analog converters, receives commands from the main unit, and reads switches through the gate array connected to the bus.

- **Gate array**

Functions such as generation of internal/external clocks from the PLL internal reference signal; analog unit interfacing; and DSP reset signal generation, command transfer from the microprocessor to the DSP, and RTK, CKY, and TXB input are implemented on a single chip to reduce the size of the digital unit circuits and increase reliability. Analog control lines MDO and IFE are controlled by the DSP via the output port of the gate array to increase the flexibility in changing the specifications of the DSP program.

- **Other DSP peripheral components**

IC41 provides timing for writing data to the gate array. IC42 is a power detection IC that outputs a low signal to the gate array if the power supply voltage drops. When the power is switched on, the output from this IC is directed to the DSP with a delay by the gate array. Q27 is an amplifier that amplifies the DSP reference signal to the gate array input level.

### 2-3. Analog Unit

The analog unit interfaces the transceiver and digital signal processing units, including the analog-to-digital and digital-to-analog converters.

#### 1) High-pass filter

The high-pass filter for sound quality adjustment (bandwidth limiting) is not an analog filter, but a digital filter for modulation that makes use of the processing capability of the DSP, and the same characteristics are used for both modulation and demodulation. The characteristics are those of a fourth-order Butterworth filter, and the cutoff frequency (-3 dB) can be obtained by the following formula:

$$F_c = 1/2 \cdot \pi \cdot \sqrt{(R_a \cdot R_b \cdot C_a \cdot C_b)} \quad (C_a = C_b)$$

The cutoff frequency of the high-pass filter can be changed in four steps by changing the resistors with analog switches. The high-pass filter switch position is set to the cutoff frequency for the overall characteristics for the notch filter and high-pass filter for SSB modulation. The cutoff frequency of the high-pass filter is used when the notch filter is off, during amplitude modulation and demodulation.

Position	HP0	HP1	HPF cutoff frequency
100	1	1	55Hz
200	0	1	135Hz
300	1	0	300Hz
400	0	0	400Hz

**Table 1 High-pass filter cutoff frequency**

#### 2) Limiting amplifier

If a signal whose amplitude is higher than the analog-to-digital converter input amplitude is input to that converter, a very large distortion occurs. To prevent this, the amplitude is limited with a limiting amplifier so that it does not exceed the full scale of the analog-to-digital converter input. This is done by clipping the amplitude with a limiting amplifier. The limiting amplifier is an operational amplifier in the HIC, and the amplitude is clipped by IC12 when it exceeds ±1.6 V.

Downloaded by  
Amateur Radio Directory  
[www.hamdirectory.info](http://www.hamdirectory.info)

## CIRCUIT DESCRIPTION

### 3) AAF, SMF

If there is a component with half the sampling frequency,  $f_s$  (Nyquist bandwidth), in the sample and hold amplifier input, the component causes a loopback distortion that cannot be removed with a filter (Figure 4). The low-pass filter that removes components other than the Nyquist band in advance is called an anti-aliasing filter (AAF). The cutoff frequency of this filter is about 6.3kHz, so that it does not affect the amplitude and group delay characteristics over the 3kHz transmission band. An active filter with simultaneous Chebyshev characteristics of degree 5 is used as the minimum characteristics for removing components other than the Nyquist band. The smoothing filter (SMF) reduces harmonics contained in the audio output. It is the same kind of HIC as the AAF. An FDNR filter used for audio equipment because of its low noise and low distortion, is used in the HIC circuit.

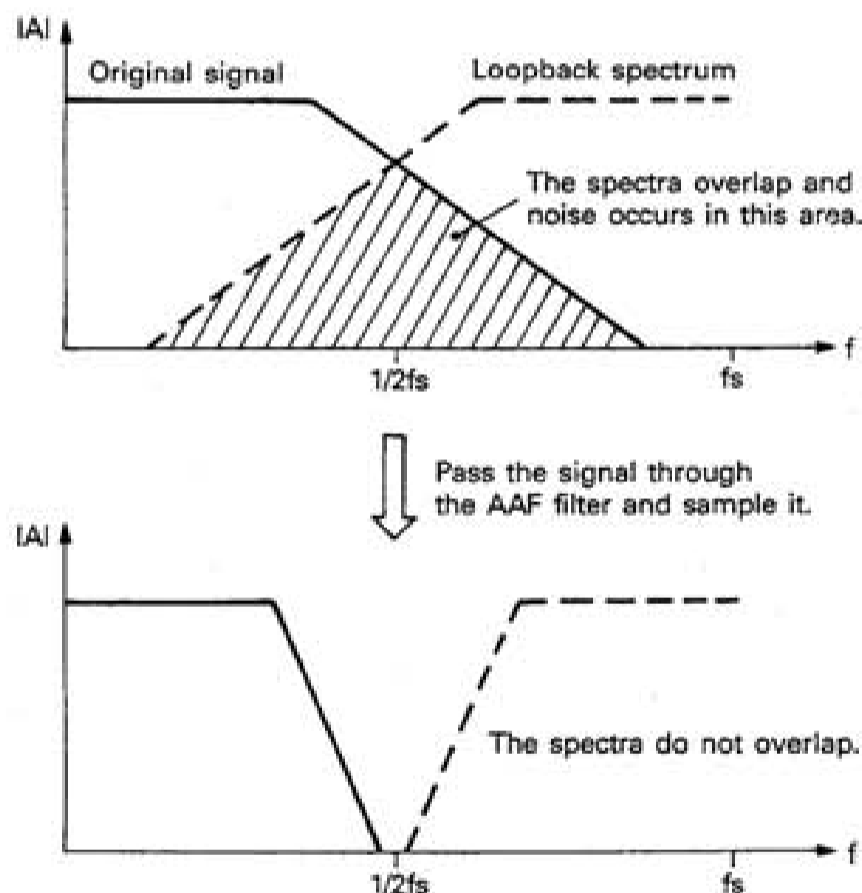
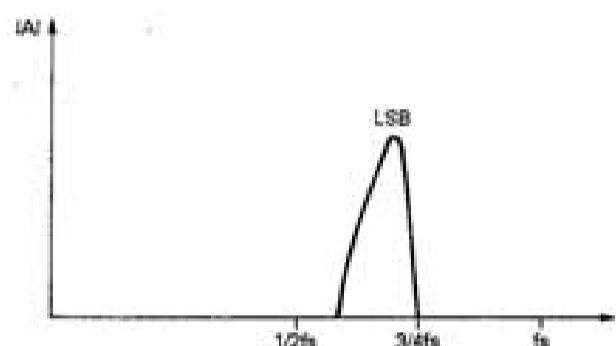

Fig. 4 Loopback distortion

### 4) Sample and hold (S/H) amplifier and analog-to-digital converter

Since the analog-to-digital converter converts signals serially, the input level must be constant during conversion. So, before the analog-to-digital converter converts signals, the sample and hold amplifier samples the input signals and outputs staircase waveforms. A 36.189kHz signal is input during detection, but the 12.297kHz output spectrum of the basic degree also appears in the output, according to the sam-

pling theorem. If the DSP detection is for the USB, the phase of the 36.189kHz signal is reversed, and the LSB is input to the sample and hold (S/H) amplifier. (Figure 5) If the SH signal from the gate array is high, Q5 is turned on, and the amplifier samples with a gain of 0 dB. If the SH signal is low, Q5 is turned off, and the sampled value is held. The output resistors of IC15/1 and IC16/1 protect the operational amplifier. D6 shifts the SH level from 0/5 to -5/0.



(a) S/H amplifier input spectrum

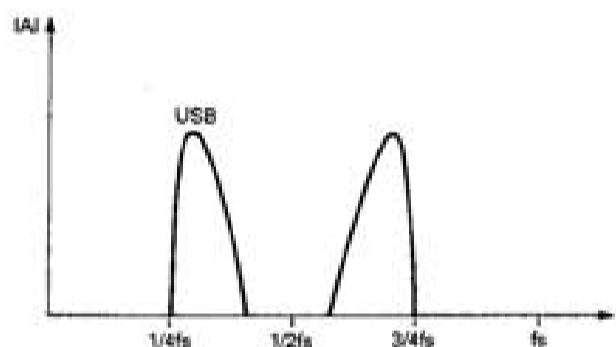

(b) S/H amplifier output spectrum

Fig. 5 SSB detection

### 5) Digital-to-analog converter circuit

The 16-bit digital serial data signal from the digital unit is converted to an analog signal by the digital-to-analog converter. This output is extracted with a duty of 50% in the modulation mode by the chopper circuit, and the digital-to-analog converter output is output as it is during AF-SLOPE. Extraction with a duty of 50% in the modulation mode improves the frequency characteristics by the aperture effect.

### 6) Band-pass filter (36.189kHz)

The 36.189±12.5kHz band-pass filter extracts the first image from the digital-to-analog converter output spectrum.

The spectrum of the digital-to-analog converter output during modulation appears at an odd number of multiples of 1/4 the sampling frequency. The 455kHz spectrum exists at 37 times the frequency, and 36.189kHz is extracted from distortion and C/N.



## CIRCUIT DESCRIPTION

### 7) Mixer

Multiplication is performed by turning the analog switch on or off with 491.189kHz, and the difference between the result and 36.891kHz is calculated, the result being converted to 455kHz. The difference is calculated because the DSP processing is for the LSB, since the phase is reversed for the first image of the digital-to-analog converter output even if the DSP processing is for the USB.

### 8) Band-pass filter (455kHz)/amplifier

Unnecessary components (components not removed by the 36.189kHz band-pass filter, and images and harmonics in the mixer) of the 455kHz signal are removed with a  $455 \pm 5$ kHz ceramic filter.

### 9) Signal changeover analog switch

#### • IC10

Switches the input to the AAF and the output to DAF2.

Mode	Signal name		Input to A/D converter	Output to DAF2
	MD0	MD1		
TX : SSB, DSB, AM	0	0	HPF through	DAF1 (IC6)
		1	HPF non-through	
TX : FM	0	0	HPF through	DAF1 (IC6)
TX : TWO TONE	0	1	A/D converter is not used.	DAF1 (IC6)
TX : FSK, PSK	1	1	AD converter is not used.	D/A converter
DSP OFF	0	0	HPF through	DAF1 (IC6)
DSP through 2	1	0	DAF1 (IC6)	D/A converter
RX : SSB, CW, DSB, FSK, DSP through 1	1	1	Mute	D/A converter

Table 2 IC10

#### • IC25

Determines whether the modulation output level is controlled either with CAR (VR2) on the front panel or with TX GAIN (VR3) on the rear panel, according to the mode.

Mode	CAR	VR
TX : SSB, DSB, TWO TONE	1	TX GAIN
TX : AM, CW, FSK, FM	0	CAR

Table 3 IC25

#### • IC30

Has the following functions:

- MUT : Mute the shock sound produced when the mode or filter is changed in the DAF2 output; produce muting in the modulation mode.
- RHPF : Demodulation HPF through on/off
- SMD0 : Mute the input to the A/D converter from DDS when SMD0 is low.

Mode	Signal name	
	RHPF	MUT
TX : SSB, DSB, AM, FM, FSK, PSK, TWO TONE	0	0
RX : SSB, DSB, CW, FSK, PSK, DSP through 1, DSP through 2	*2	*3
DSP OFF	0	*3

Table 4 IC30

#### • Q1, Q2, Q3, Q4

Q1, Q2, Q3, and Q4 function as an analog switch if SMD0 is high. If the detected IF input is not used, the switch is turned off to prevent unnecessary signals from entering the A/D converter. If the input is large, it is clipped by Q2 and Q3. If SMD0 is low and IFE is high, Q1, Q2, Q3, and Q4 function as a mixer. IC14 provides the control logic for this. D4 and D5 are level shift diodes that turn Q2 and Q3 on and off with IC14. R52 of the amplifier of IC13 in the previous stage produces a bias so that the Q1 emitter voltage is 0V.

Mode	IFE
TX : SSB, DSB, AM, FM, TWO TONE	0
RX : DSP through 2, DSP OFF	
RX : SSB, DSB, FSK, PSK, CW, DSP through 1	1
TX : FSK, PSK, CW	

Table 5 Detected IF input switch

### 2-4. DDS

An IIR filter with a sharp characteristic exhibits a phenomenon called a zero input limit cycle, in which a filter output appears when there is no input, as if the filter is oscillating. To prevent this phenomenon, the DSP-100 applies a DDS output that matches the attenuation peak of the filter to the analog-to-digital converter in modes in which a filter that produces a noise is used. Since this signal is always input to the filter, the noise specific to the zero input limit cycle is suppressed. Since the DDS signal frequency is the attenuation peak of the filter, it is attenuated sufficiently and does not appear in the output. 45.090kHz is generated in modes in which a notch filter is used for modulation. 43.721kHz is generated in modes in which a notch filter is not used, but a low-pass filter is. 31.424kHz is generated in modes in which a low-pass filter is used for detection.

## CIRCUIT DESCRIPTION

### Frequency Relationship

The DSP-100 uses a sampling frequency of 49.189kHz (a nonterminating decimal) to obtain 455kHz when the carrier signal frequency is a quarter the sampling frequency with the following frequency relationship:

$$\begin{aligned} f_{\text{DSPSTD}} &= 1000 \times 728/185 \times 10 \times 10^3 \\ &= 728/185 \times 10 \times 10^6 \quad (10\text{kHz input}) \end{aligned}$$

$$f_{\text{DSPSTD}} = 728/185 \times 10 \times 10^6 \quad (10\text{MHz input})$$

$$f_{\text{MIX}} = f_{\text{DSPSTD}}/80, f_s = f_{\text{DSPSTD}}/800$$

$$f_{455} = f_{\text{MIX}} - 3/4f_s = 37/3200f_{\text{DSPSTD}}$$

### Digital Signal Processing

#### 1. Processing with DSP

The functions used for digital modulation and demodulation are described below.

##### 1) IIR filter

The IIR filter has a sharp characteristic with a low degree. Design data for analog filters can be used as a coefficients for Z conversion or bilinear conversion. The characteristics of a digital filter of degree  $n$  are the same as those of an analog filter of degree  $n$ .

##### 2) FIR filter

Filters with linear phases can be designed. The signal-to-noise ratio of the FIR filter is higher than that of the IIR filter, but its degree must be high to obtain sharp characteristics.

##### 3) Phase shifter

An all-pass filter of degree 1 with a IIR filter connected in series is used for phase shifting. This phase shifter has a flat response, but if the phase shifter is built with analog components, there are phase variations and amplitude errors. For the phase shifter, the filter peak must be the same as the zero point to make the amplitude flat, but when analog components are used, the peak does not match the zero point because of variations. The phase shifter for digital signal processing does not suffer from this problem, and assures a flat response and an accurate phase difference.

##### 4) Comb filter

The tandem-type filter has superior attenuation at the notch frequency.

Normally, the comb filter has broad frequency characteristics, but the DSP-100 combines a tandem-type filter with a return-type filter (IIR filter) to extend the frequency characteristics to the notch frequency. Since this filter also has the characteristics of the IIR filter, its operation does not become stable when there is no input, and carrier leak occurs due to oscillation called limit cycle oscillation. The generation of the limit cycle is prevented by the DDS inputting a signal at the notch frequency to obtain effective carrier suppression.

##### 5) ROM filter

The ROM filter for digital signal processing consists of a filter that uses multipliers and adders and a ROM that contains data and outputs responses to input data.

##### 6) Multiplier (balance modulation, product detection)

Balance modulation is performed by multiplying  $1/4f_s$  by the modulation signal with a  $16 \times 16$  bit multiply instruction. Product detection is performed by multiplying  $1/4f_s$  by the IF signal. Thus, characteristics can be modulated properly without distortion.

##### 7) Multirate processing

When the sampling frequency is high, the load on the analog circuits, such as a filter for analog-to-digital and digital-to-analog conversion, decreases. As the sampling frequency increases, the number of instructions that can be executed in one sampling period decreases, coefficients errors, and rounding and limit cycle noise increases in the IIR filter. The DSP processes the sampling frequency of a part of the low-pass filter and the phase shifter in SSB modulation by  $1/2f_s$  using software to assure the necessary processing steps and performance.

### 2. Simulation

The characteristics of the low-pass filter, high-pass filter, and phase shifter are converted from analog factors for use in the digital filter, and the factors are quantified to 16 bits. The characteristics are changed slightly by the quantization, and the cutoff frequency shifts or the side-band suppression characteristics deteriorate. So, the characteristics are corrected by carrying out simulation with the quantified value.

## CIRCUIT DESCRIPTION

### 3. SSB modulation

#### • SSB modulation by analog signal processing

Analog SSB modulation circuits are built based on the following typical methods:

1. Filter method; Suppresses unnecessary side bands of the balance-modulated output with a filter
2. PSN method; Suppresses unnecessary side bands by obtaining a modulation signal with a phase difference of  $90^\circ$  from the phase circuit (PSN), balance-modulating it with a carrier signal with a phase difference of  $90^\circ$ , then adding the outputs.

Since the latter method, unlike the filter method, does not require a filter with a sharp characteristic, and can obtain a high side-band suppression ratio from a low frequency range with a broad-band phase shifter, it produces higher sound quality than the filter method, and is superior to the filter method in obtaining wide frequency characteristics. However, PSN with analog phase shifters has not provided good characteristics because of variations, instability of analog parts, and an adjustment problem, and it has not been widely used.

#### • SSB modulation by digital signal processing

There are several methods: methods specific to digital signal processing and methods where the conventional analog method is replaced by digital signal processing. The DSP-100 uses the PSN method in the latter group of methods, which provides high sound quality as well as the processing capability and characteristics. SSB with good characteristics can be obtained by using an accurate, stable phase shifter by digital signal processing.

#### • PSN modulation by DSP-100

Figure 6 is a block diagram of SSB modulation processing.

The DSP-100 uses two groups of five all-pass phase shifters of degree 1 connected in series to obtain side-band suppression characteristics over 70dB. When the two phase shifters have a phase difference of  $90^\circ$ , unnecessary side bands are suppressed, but good characteristics can be obtained only in a certain band. If the degree of the phase shifter is fixed and the band is narrowed, the phase of  $90^\circ$  is approximated, and the side-band suppression characteristics are improved. If the band is widened, the side-band suppression characteristics are reduced (Figure 7).

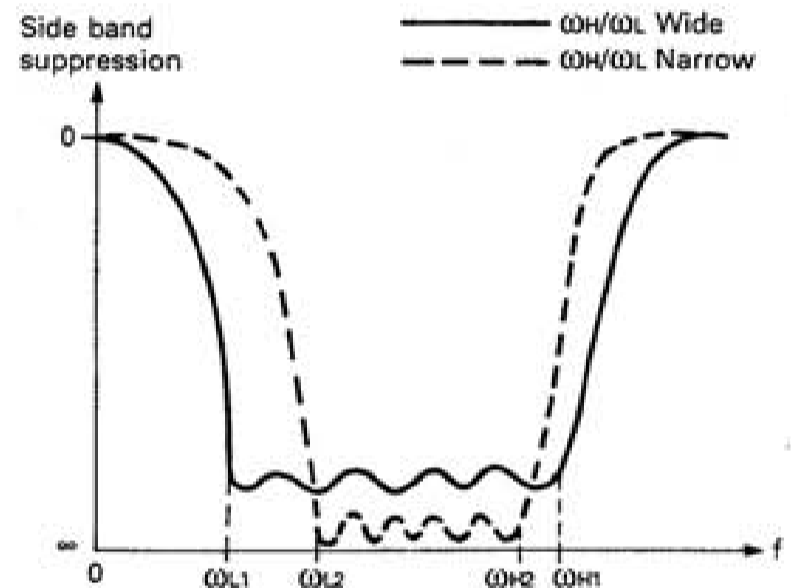

Fig. 7 PSN band

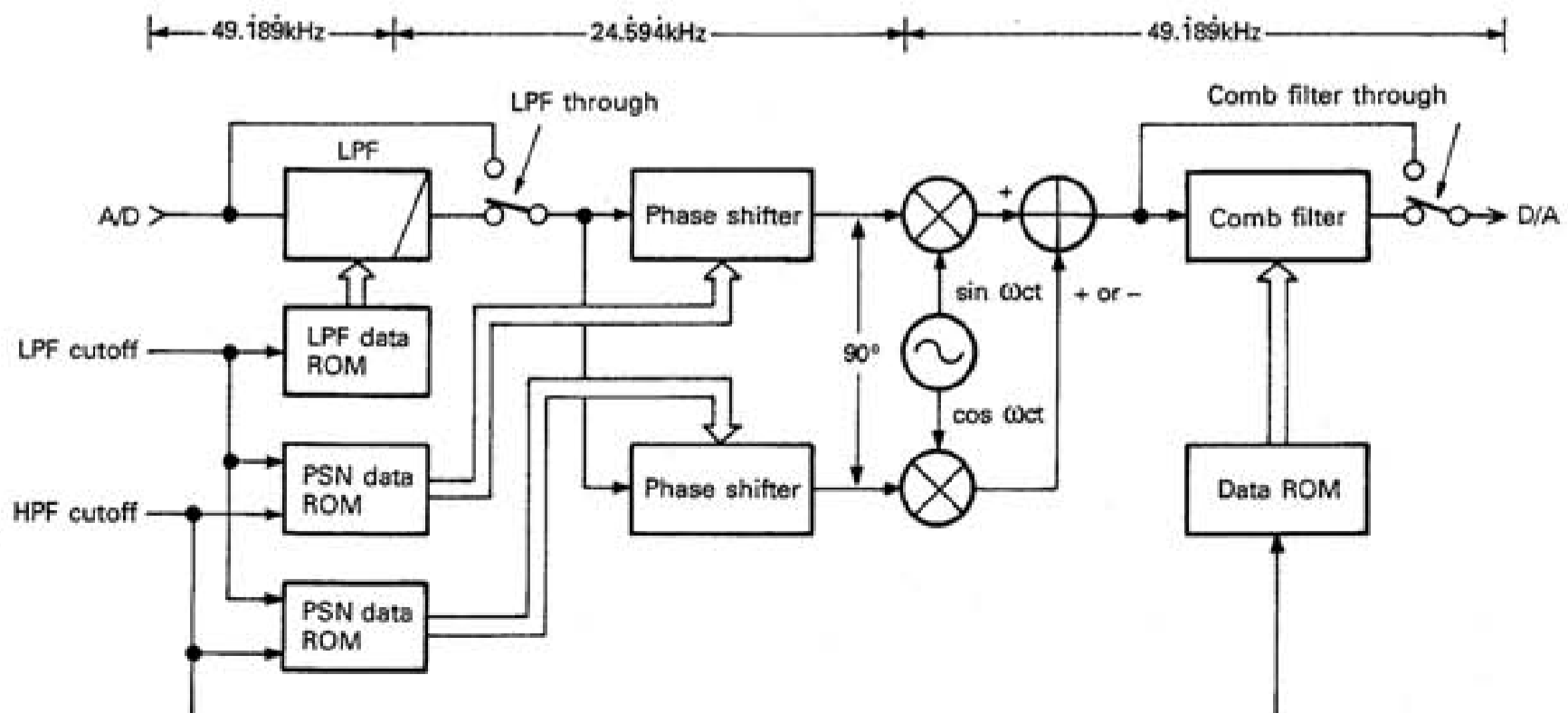

Fig. 6 SSB modulation block diagram

## CIRCUIT DESCRIPTION

To improve the side-band suppression characteristics, it is necessary to increase the degree of the phase shifter or narrow the 90° band of the phase shifter. If the degree of the phase shifter is increased, the group delay time increases in the low-frequency range for the phase shifter composed of the phase shifters of degree 1 connected in series, and the group delay characteristics deteriorate, requiring faster operation processing; so this method is not recommended. The DSP-100 provides the optimum characteristics for the transmission band without the leak of unnecessary side bands in the low- and high-frequency ranges by changing the design band ratio of the phase shifter and frequency according to the band with a combination of a high-pass filter and a low-pass filter. Table 6 shows this combination set to improve the side-band suppression ratio when the band is narrow.

Theoretically, there should be no carrier leak in ideal modulation with digital multipliers, but an offset voltage occurs due to the analog-to-digital converter offset and noise due to the operations of the low-pass filter or phase shifter, and carrier leak occurs. The DSP uses a digital tandem-type filter to suppress the carrier.

HPF	LPF	Phase shifter band
100 through	2600, 2750	60-3435Hz/70dB
	2900, 3100, Through 2	75-4296Hz/70dB
200	2600, 2750	129-3696Hz/74dB
	2900, 3100, Through 2	75-4296Hz/70dB
300	2600, 2750, 2900, 3100, Through 2	190-5423Hz/74dB
400	2600, 2750, 2900, 3100, Through 2	220-6303Hz/74dB

Note : The phase shifter bands are the bands before quantization; the actual bands are not the same as these bands.

**Table 6 Phase shifter design band**

### 4. CW

Figure 8 is a block diagram of CW processing. Whether to generate a 455 carrier is determined by the signal rectified by the ROM filter according to the data from the key.

The ROM filter has Gaussian characteristics. With Gaussian characteristics, the output has little distortion when they are used for limiting the band of signals of 1 and 0. To implement such characteristics with an analog filter, the amplitude characteristics cannot be reproduced easily and the structure is complicated, so the filter must have broader characteristics than a linear phase filter with similar characteristics to prevent key clicks. The DSP provides good CW waveforms without key clicks even if the rising slope is sharp compared with analog filters.

Since the DSP CW spectrum is centralized at the carrier and the transmission band is narrowed, there is less influence than before when the receiver passes it through a narrow-band filter. The CW rise time is normally 4ms, but 2, 4, 6, and 8ms can be selected as desired. In CW mode, modulation and demodulation are changed by TXB, not by a command from the microprocessor.

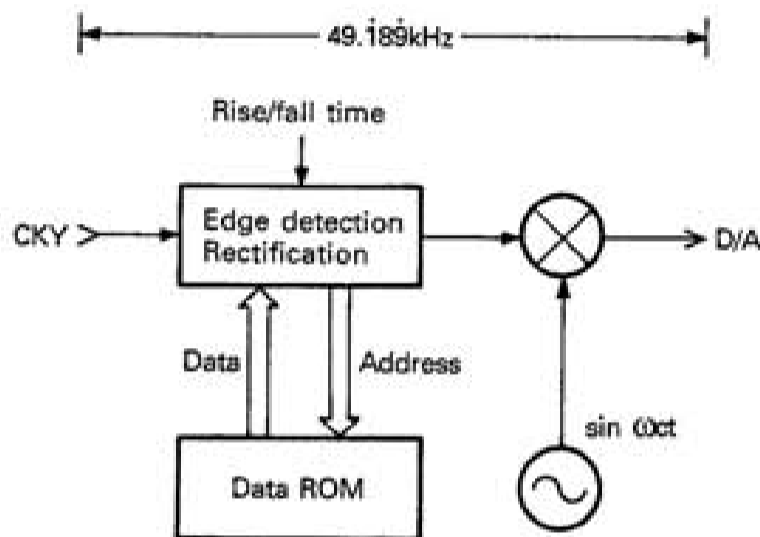
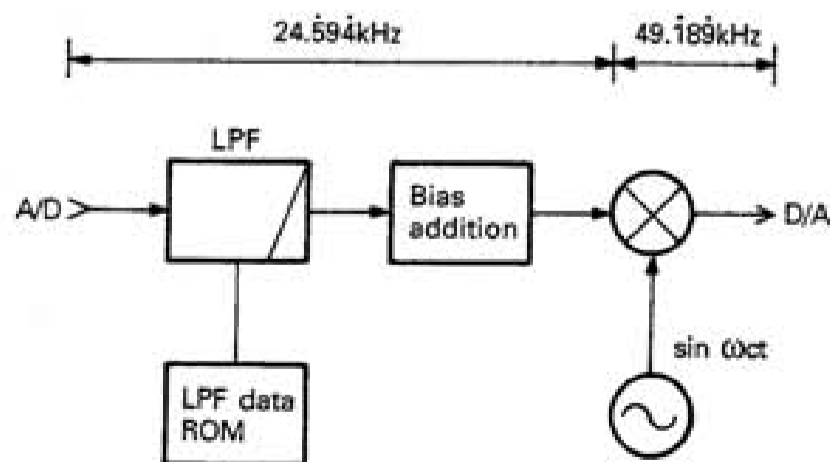

**Fig. 8 CW block diagram**

### 5. Amplitude modulation

Figure 9 is a block diagram of amplitude modulation processing.

The modulation signal from the analog-to-digital converter is band-limited by the low-pass filter, and multiplied by the carrier with an offset to produce an amplitude modulation wave. The low-pass filter for band limiting is an FIR filter of degree 84 to provide good frequency and flat group delay characteristics. For the amplitude characteristics, a modulated wave with little distortion can be obtained to 100% modulation because of linear modulation with digital multipliers.



**Fig. 9 Amplitude modulation block diagram**

## CIRCUIT DESCRIPTION

### 6. FSK modulation

Figure 10 is a block diagram of FSK modulation processing.

The mark and space frequencies are generated directly by digital signal processing according to the frequency shift data from the RTK line. While the CW mode uses the ROM filter method, the FSK mode uses a FIR filter with Gaussian characteristics to shape the waveform for high-speed conversion. Because of this waveform shaping, there is little interference between

the mark and space frequencies, and the distortion of the modulated wave is reduced since the signal is modulated with continuous phases by the DDS generator in FSK modulation.

Strictly, the step of the frequency that can be generated by the DSP is 3.0023Hz, and the shift widths are 171.129, 201.152, 426.322, and 849.642, which are slightly different from 170, 200, 425, and 850, but in practice, give no problem.

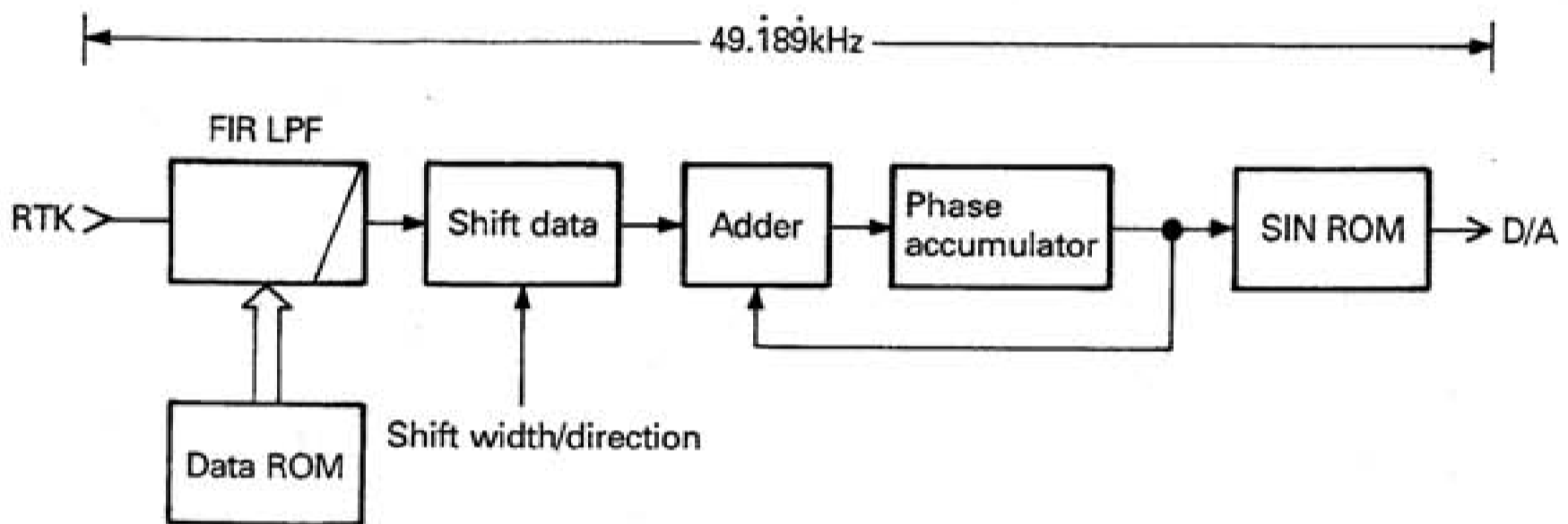

Fig. 10-a FSK block diagram

### 32 gaus FIR

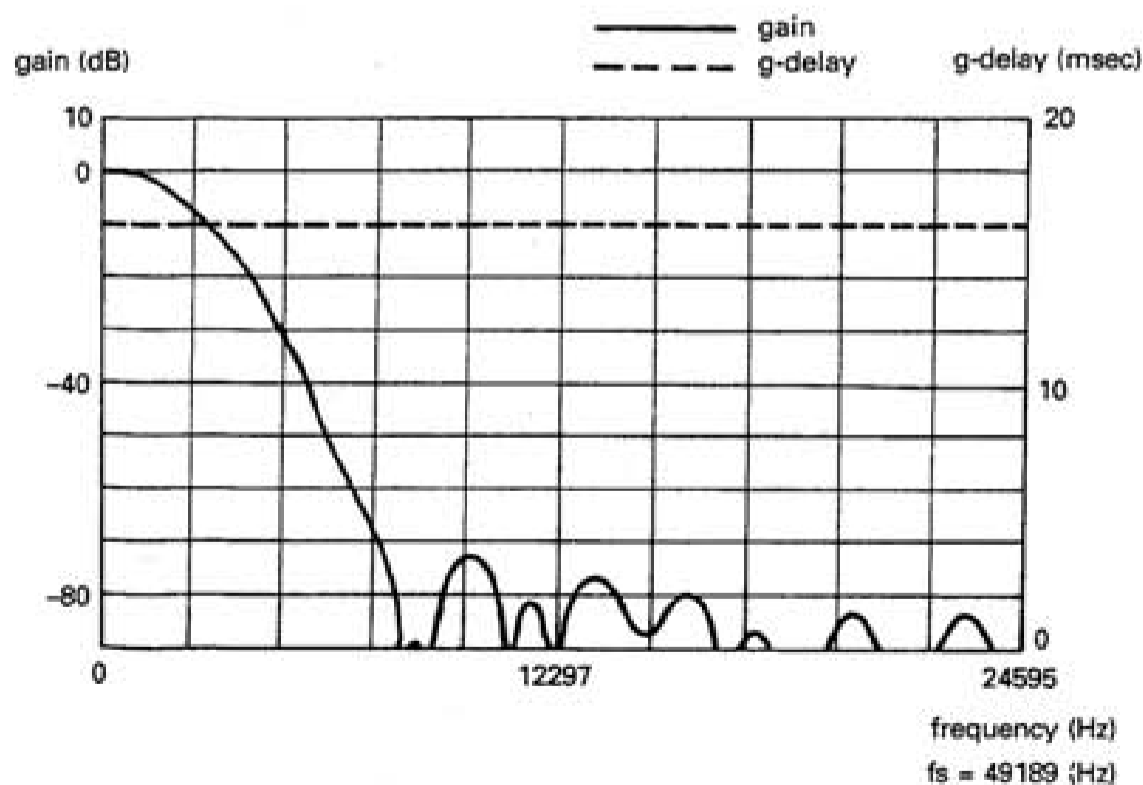

Fig. 10-b FIR filter for FSK frequency characteristics

## CIRCUIT DESCRIPTION

### 7. SSB detection (including detection in CW and FSK)

Figure 11 is a block diagram of PSN detection processing.

The position of the multiplier is changed and there is no notch filter in the PSN detection circuit compared with the configuration for modulation. The factors used by the filter are the same as those for modulation. While PSN modulation obtains an IF signal for one side band of the carrier frequency from the audio signal, PSN detection obtains the audio signal from the one side band above or below the detection frequency.

### 8. DSB detection (including detection in CW and FSK)

Figure 12 is a block diagram of PSN detection processing.

The DSB detection circuit is the same as the SSB detection circuit except that there is no phase shifter. The principle is the same as for product detection. Compared with SSB detection, less noise is generated in the DSP because there is no phase shifter, and the signal-to-noise ratio is improved, but the practical input noise is larger than the SSB detection because both side bands are detected.

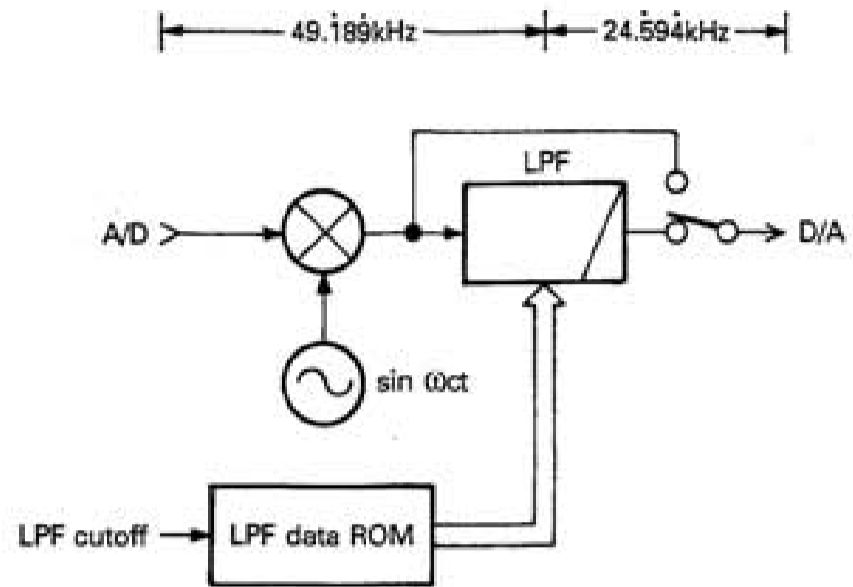

Fig. 12 DSB detection block diagram

Downloaded by  
Amateur Radio Directory  
[www.hamdirectory.info](http://www.hamdirectory.info)

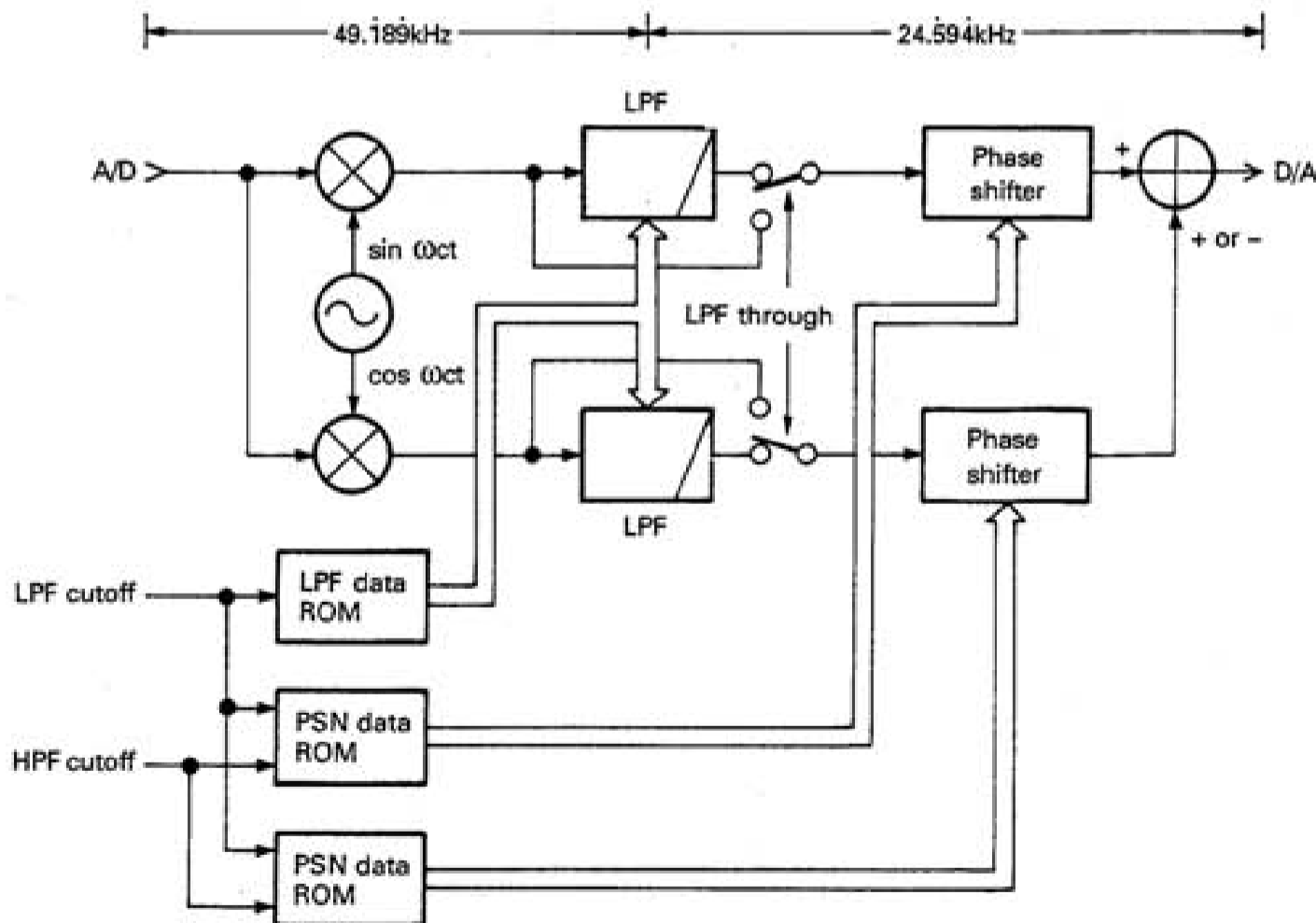

Fig. 11 SSB detection block diagram

## CIRCUIT DESCRIPTION

### • CPU : 647180XOFS6JBR2 port assignment

Pin name	IC			Operation			Remarks
	Pin	I/O	Signal name	Function	Condition for being active	H/L	
MNI	1	I		Unused			
INT0-INT2	2-4	I		Unused			
PE4	5	O		Enable DDS		H	IC22
PC0	6	O	MD1	Analog switch changeover			
PC1	7	O	RHPF	RX high-pass filter through			
PC2	8	O	MUT	Mute		L	
PC3	9	O	HP0	High-pass filter switch cord 0			
Vss	10						
PC4	11		HP1	High-pass filter switch cord 1			
PC5	12	O	CAR	Carrier volume selection			
PC6,PC7	13,14	O		Unused			
PD0-PD3	15-18	I		Key scan input			
PD4,PD5	19,20	O		Key scan output		L	Rotary switch high-pass filter
PD6	21	O		Key scan output		L	Push switch
PD7	22	O		Unused			
PE0	23	O	PSD	Serial data			IC22, 26, 31
PE1	24	O	PSC	Serial clock			IC22, 26, 31
PE2	25	O	ISC	Enable DSP		H	IC31
TOUT1	26	O		Unused			
Vcc	27						
PE3	28	O	PEN	Serial enable		H	IC26 (PLL)
Vss	29						
PF0	30	I		DIP switch input			SW1
PF1	31	I		DIP switch input			SW2
PF2	32	I		DIP switch input			SW3
PF3	33	I		DIP switch input			SW4
PF4	34	I		DIP switch input			SW5
PF5	35	I		DIP switch input			SW6
PF6	36	I		DIP switch input			SW7
PF7	37	I		DIP switch input			SW8
Vss	38						
PG0/AN0	39	I		DIP switch input			SW9
PG1/AN1	40	I		DIP switch input			SW10
PG2/AN2-PG5/AN5	41-44	I		Unused			
RTS0	45	O					RS-232C (J1)
CTS0	46	I					RS-232C (J1)
DCD0	47	I		Inable RX			Fixed at low
TXA0	48	O					RS-232C (J1)
RXA0	49	I					RS-232C (J1)
CKA0/	50	O		Unused			/DREQ0
TOUT2,TOUT3	51,52	O		Unused			
IC	53			Unused			
TXA1/	54	O		TX data			RS-232C (J2)/PA0
RXA1/	55	I		RX data			RS-232C (J2)/PA1
CKA1/	56	O		RTS1			RS-232C (J2)/TEND0/PA2
TXS/	57	O		Unused			/PA3
RXS/	58	I		CTS and data (TS-950)			/CTS1/PA4
CKS/	59	I		CK (TS-950)			/PA5
DREQ1/	60	I		Enable (TS-950)		L	/PA6
TEND1/	61	O		Unused			/PA7

## CIRCUIT DESCRIPTION

Pin name	IC			Operation			Remarks
	Pin	I/O	Signal name	Function	Condition for being active	H/L	
PB7-PB4	62-65			Unused			
PB3	66	O	DBC	DSP presence/absence signal			
PB2	67	I	SMOD	TS-950 mode selection	TS-950 mode	L	
PB1	68	I	UNLK	Unlock signal	Unlock	H	
PB0	69	I	TXB	Transmit/receive changeover signal	TX	L	
Vss	70						
e	71	O					
MP1	72	I		CPU operation mode determination	Fixed	L	single chip mode
MP0	73	I				L	
XTAL	74	I					
EXTAL	75	I					
Vcc	76						
PE7-PE5	77-79	O		Unused			
RESET	80	I					

### • Pulse waveform design

#### Timing from the microprocessor to PLL and DSP

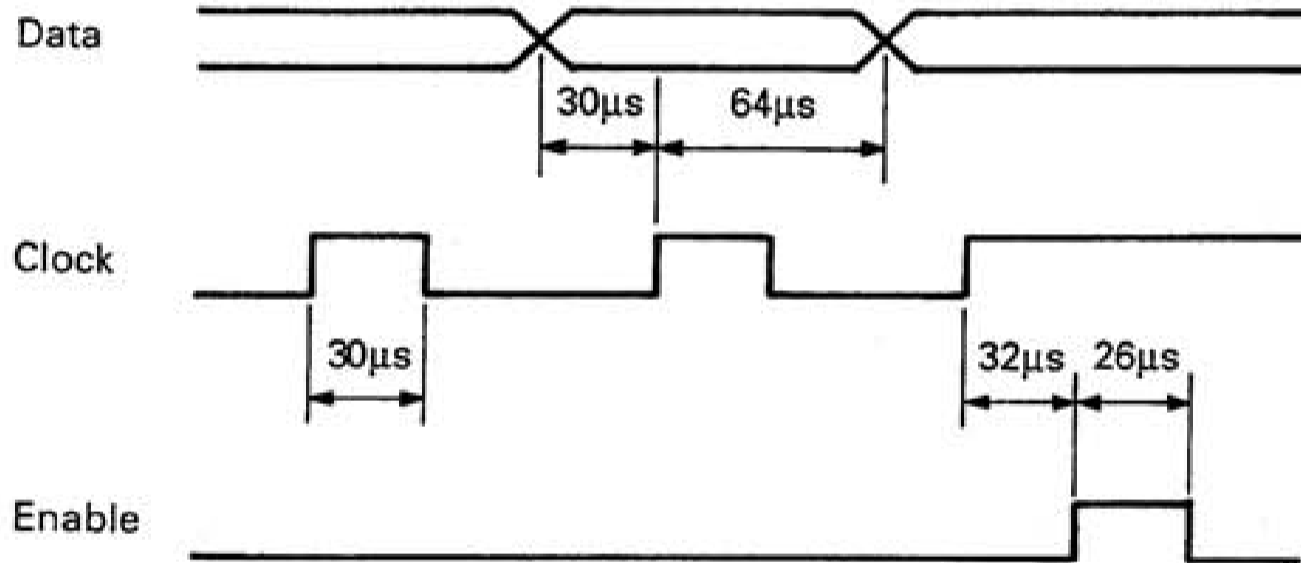

#### Key scan timing

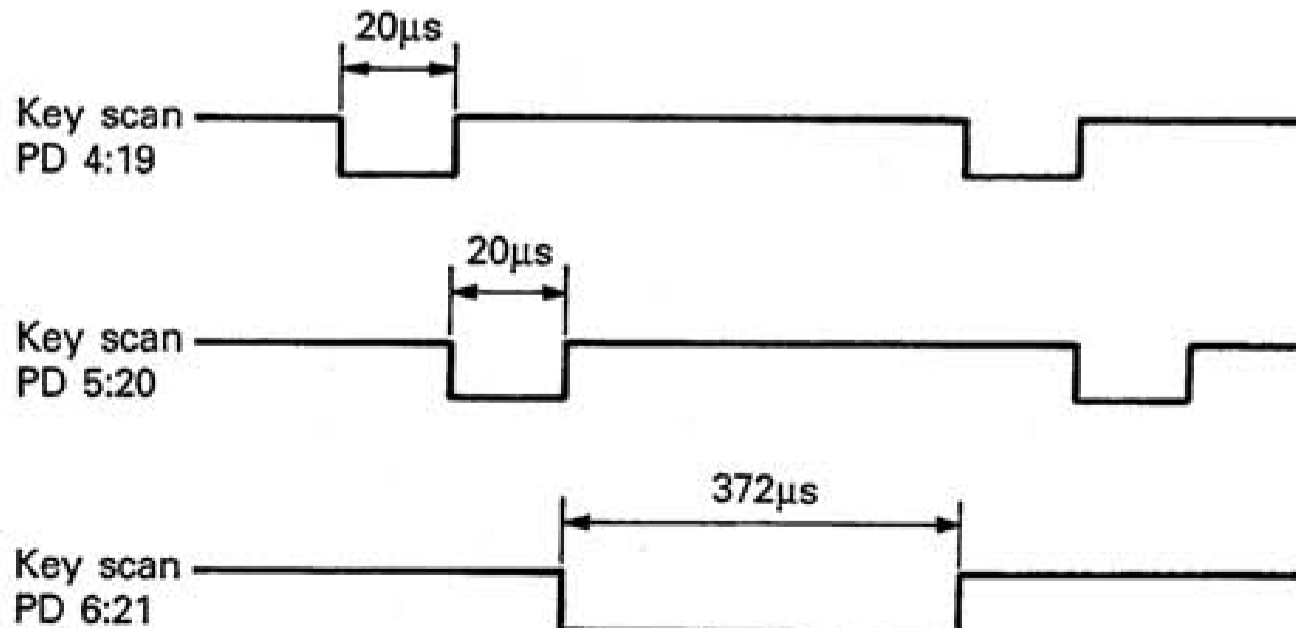



## DESCRIPTION OF COMPONENTS

Ref. No.	Use/Function	Operation/Condition/Compatibility
IC1	Power supply	+15V
IC2	Power supply	-12V
IC3	Power supply	+5V
IC4	Power supply	-5V
IC5	Operational amplifier	5/1 : 25.5dB normal phase amplifier 5/2 : 6.6dB differential amplifier
IC6	Operational amplifier	6/1 : 5dB differential amplifier 6/2 : Output budder (0dB)
IC7	Switch	Changes the impedance of the first high-pass filter for modulation.
IC8	Switch	Changes the impedance of the second high-pass filter for modulation.
IC9	Operational amplifier	For the high-pass filter
IC10	Switch (2 circuits, 4 contacts)	A/D input, DAF2 output change
IC11	LPF	Limiter amplifier, low-pass filter of degree 5 (AAF)
IC12	Operational amplifier	Clipper for limiter amplifier
IC13	Operational amplifier	13/1 : Detection input 34dB normal phase amplifier 13/2 : Low-pass filter for removing DDS distortion
IC14	Gate	Detection input analog switch control
IC15,16	Operational amplifier	S/H amplifier
IC17	Analog-to-digital converter	16 bit serial output
IC18	Gate	Buffer
IC19	Flip-flop	Timing adjustment
IC20	Digital-to analog converter	16 bit serial input
IC21	Switch	D/A output chopper
IC22	Operational amplifier	D/A buffer
IC23	Switch	Mixer
IC24	Operational amplifier	20dB reversing amplifier Input resistor (R103), ceramic filter matching
IC25	Switching	Change between CAR and TX GAIN
IC26	LPF	-6.5dB amplifier and low-pass filter of degree 5
IC27	Switch	Changes the impedance of the first high-pass filter for detection
IC28	Switch	Changes the impedance of the second high-pass filter for detection
IC29	Operational amplifier	For the high-pass filter
IC30	Switch	DAF2 (audio output) muting, receive high-pass filter through, DDS signal off
IC31	DDS	Zero input limit cycle suppression
IC32	PLL	10MHz PLL P.D. divider
IC33	Division	1/10
IC34	Power supply	+8V
IC35	PLL	39.351MHz PLL
IC36	Power supply	+5V
IC37	CPU	Control
IC38	Reversing gate	Buffer
IC39	DSP	Signal processing
IC40	Gate array	Timing generation, interface between DSP and analog processing
IC41	Gate	Adjustment of timing to the gate array
IC42	Power supply voltage detection	DSP-100 reset voltage detection
IC43	XOR	Level reversal on/off
IC44	Power supply voltage detection	Absorbs shock sounds when the power is switched on or off

# DSP-100

## DESCRIPTION OF COMPONENTS

Ref. No.	Use/Function	Operation/Condition/Compatibility
Q1	Buffer	Analog switch
Q2,3	Switch	Analog switch
Q4	Buffer	Analog switch
Q5	Switch	S/H
Q6,7	Buffer	Mixer
Q8	Buffer	Modulation IF output
Q9	Buffer	DDS D/A
Q10	Amplifier	IC14 level conversion
Q11	Amplifier	DDS level conversion
Q12	OSC	10MHz VCXO
Q13	Buffer	10MHz VCXO
Q14	Amplifier	Input amplifier when the reference signal is 10MHz
Q15	Amplifier	IC32 level conversion when the reference signal is 10kHz
Q16	Buffer	10MHz buffer
Q17	Buffer	PLL active filter
Q18,19	Amplifier	PLL active filter
Q20	OSC	39.351MHz VCO
Q21	Buffer	VCO buffer
Q22	Buffer	Buffer for the digital unit
Q23	Switch	IC32 unlock output reversal
Q24	Level conversion	TXB level conversion and reversal
Q25	Level conversion	RTK level conversion and reversal
Q26	Switch	DBC (DSP active signal) on/off
Q27	Amplifier	IC40 level conversion
Q28	Switch	IC44 output reversal
Q29	Switch	Absorbs shock sounds when the DAF2 power is switched on or off
D1	Rectification	+ power supply rectification
D2	Rectification	- power supply rectification
D3	Switch	Limiter amplifier
D4-6	Zener diode	Level shift
D7	Vari-cap	10MHz VCXO
D8	Switch	Limiter when the reference signal is 10MHz
D9	Vari-cap	39.351MHz VCO
D10	OR	PLL unlock diode OR
D11	Switch	Input protection
D12	Switch	Key strobe
D13,14	Switch	Key return
D15	LED	DSP-100 on

## PARTS LIST

\* New Parts

Parts without Parts No. are not supplied.

Les articles non mentionnés dans le Parts No. ne sont pas fournis.

Teile ohne Parts No. werden nicht geliefert.

Ref. No. 参照番号	Address 位置	New Parts 新	Parts No. 部品番号	Description 部品名 / 規格	Desti- nation 仕向	Re- marks 備考
<b>DSP-100</b>						
1	1B	*	A01-2026-02	METALLIC CABINET		
2	3A	*	A62-0079-03	PANEL		
-	-		B41-0525-04	CAUTION LABEL(FUSE)	KP	
-	-		B42-2454-04	LABEL(S/NØ, CARTON BOX)		
-	-		B42-3343-04	LABEL(MØDEL NAME PLATE)		
7	1C		B46-0410-30	WARRANTY CARD	K	
7	1C		B46-0419-20	WARRANTY CARD	E	
7	1C		B46-0422-00	WARRANTY CARD	P	
9	1C	*	B62-0077-00	INSTRUCTION MANUAL		
12	2B	*	B72-0154-04	MØDEL NAME PLATE	KP	
12	2B	*	B72-0155-04	MØDEL NAME PLATE	MXE	
-	-		B42-3355-04	SPEC LABEL(EARTH)	XE	
-	-		B42-3395-04	SPEC LABEL	K	
15	2B, 2C		E30-0974-05	AC POWER CØRD	KMP	
15	2B, 2C		E30-2153-15	AC POWER CØRD	E	
15	2B, 2C		E30-2159-15	AC POWER CØRD	X	
16	3C	*	E30-3047-05	CONNECTING WIRE(6P,ACSY)		
17	3D	*	E30-3048-05	CONNECTING WIRE(13P,ACSY)		
18	3C	*	E30-3055-05	CONNECTING WIRE(PIN,ACSY)		
19	3D	*	E30-3056-05	CONNECTING WIRE(PIN,ACSY)		
F1	3D		F05-2012-05	FUSE(0.2A) ACSY X1	MX	
F1	3D		F05-2015-05	FUSE(0.2A) ACSY X1	E	
F1	3D		F05-3011-05	FUSE(0.3A) ACSY X1	KP	
-	-		G02-0574-04	SPRING		
30	3C	*	H10-2720-01	PØLYSTYRENE FØAMED FIXTURE(F)		
31	2D	*	H10-2721-01	PØLYSTYRENE FØAMED FIXTURE(K)		
32	3D		H25-0103-04	PROTECTION BAG(WIRE)		
33	2C		H25-0752-04	PROTECTION BAG(DSP-100)		
34	2D	*	H52-0094-04	ITEM CARTON BOX		
36	3B		J02-0439-05	FOOT		
37	2B		J42-0083-05	POWER CØRD BUSHING	KMP	
37	2B		J42-0085-05	POWER CØRD BUSHING	XE	
38	2B		J61-0307-05	WIRE BAND		
40	3A		K23-0794-04	KNØB(ROTARY SW)		
41	3A		K29-4513-04	KNØB(PUSH SW)		
42	3A		K29-4636-04	KNØB(POWER SW)		
43	3A	*	K29-4682-04	KNØB ASSY(VØL.)		
50	2A	*	L07-1009-05	POWER SUPPLY TRANSFORMER	KP	
50	2A	*	L07-1010-05	POWER SUPPLY TRANSFORMER	MXE	
A	2A		N09-2084-05	SCREW		
B	3A		N32-3012-46	FLAT HEAD MACHINE SCREW		
C	1A, 1B		N33-3006-41	OVAL HEAD MACHINE SCREW		
D	1B, 2B		N87-2606-46	BRAZIER HEAD TAPTITE SCREW		
E	3A		N88-2606-46	FLAT HEAD TAPTITE SCREW		
S9	2A		S40-2460-05	PUSH SWITCH		
D15	3A		TLR205	LED		
70	2A, 2B	*	X53-3360-00	DSP UNIT		

E: Scandinavia & Europe K: USA P: Canada W: Europe

U: PX(Far East, Hawaii) T: England M: Other Areas

UE: AAFES(Europe) X: Australia

 indicates safety critical components.

# DSP-100

## PARTS LIST

× New Parts

Parts without Parts No. are not supplied.

Les articles non mentionnés dans le Parts No. ne sont pas fournis.

Teile ohne Parts No. werden nicht geliefert.

Ref. No. 参照番号	Address 位置	New Parts 新	Parts No. 部品番号	Description 部品名 / 规格	Desti- nation 仕 向	Re- marks 備考
<b>DSP UNIT (X53-3360-00)</b>						
C1			C91-0647-05	CERAMIC 0.01UF P		
C2 ,3			C91-1075-05	CERAMIC 470PF K		
C4 -11			CK73FB1E223K	CHIP C 0.022UF K		
C12			C90-2110-05	ELECTRØ 3300UF 35WV		
C13 ,14			CK73FB1E223K	CHIP C 0.022UF K		
C15			C90-2045-05	ELECTRØ 2.2UF 25WV		
C16			C90-2110-05	ELECTRØ 3300UF 35WV		
C17 ,18			CK73FB1E223K	CHIP C 0.022UF K		
C19			C90-2045-05	ELECTRØ 2.2UF 25WV		
C20			CK73FB1H102K	CHIP C 1000PF K		
C21 ,22			CE04EW1E331M	ELECTRØ 330UF 25WV		
C23			CK73EB1H104K	CHIP C 0.10UF K		
C24			CK73FB1H102K	CHIP C 1000PF K		
C25			CE04EW1E331M	ELECTRØ 330UF 25WV		
C26			CK73EB1H104K	CHIP C 0.10UF K		
C27			CK73FB1H102K	CHIP C 1000PF K		
C28			CE04EW1E220M	ELECTRØ 22UF 25WV		
C30			CE04EW1E220M	ELECTRØ 22UF 25WV		
C32 ,33			CE04EW1C470M	ELECTRØ 47UF 16WV		
C34			CE04EW1E101M	ELECTRØ 100UF 25WV		
C35			CK73FB1E223K	CHIP C 0.022UF K		
C36			CE04EW1E101M	ELECTRØ 100UF 25WV		
C37			CK73FB1E223K	CHIP C 0.022UF K		
C38			CE04EW1E220M	ELECTRØ 22UF 25WV		
C39			CK73FB1E223K	CHIP C 0.022UF K		
C40			CE04EW1E220M	ELECTRØ 22UF 25WV		
C41 -43			CK73FB1E223K	CHIP C 0.022UF K		
C44			CE04EW1E220M	ELECTRØ 22UF 25WV		
C45 ,46			C90-2045-05	ELECTRØ 2.2UF 25WV		
C47			CE04EW1E220M	ELECTRØ 22UF 25WV		
C48			CE04EW1E101M	ELECTRØ 100UF 25WV		
C49			CK73FB1E223K	CHIP C 0.022UF K		
C50			CE04EW1E101M	ELECTRØ 100UF 25WV		
C52			CE04EW1C470M	ELECTRØ 47UF 16WV		
C53			CK73FB1E223K	CHIP C 0.022UF K		
C54			CE04EW1C470M	ELECTRØ 47UF 16WV		
C55 -57			CK73FB1E223K	CHIP C 0.022UF K		
C58			C90-2045-05	ELECTRØ 2.2UF 25WV		
C59			CK73FB1E223K	CHIP C 0.022UF K		
C60			C90-2045-05	ELECTRØ 2.2UF 25WV		
C61			CK73FB1E223K	CHIP C 0.022UF K		
C62			CE04EW1C470M	ELECTRØ 47UF 16WV		
C63			CK73FB1H102K	CHIP C 1000PF K		
C64			CE04EW1C470M	ELECTRØ 47UF 16WV		
C65 ,66			CK73FB1H102K	CHIP C 1000PF K		
C67			CK73FB1E223K	CHIP C 0.022UF K		
C68			CE04EW1C470M	ELECTRØ 47UF 16WV		
C69			CE04BW1E100M	NP-ELEC 10UF 25WV		
C70			CC73FCH1H102J	CHIP C 1000PF J		
C71			CC73FCH1H101J	CHIP C 100PF J		
C72			CC73FCH1H102J	CHIP C 1000PF J		
C73			CC73FCH1H101J	CHIP C 100PF J		
C74 -78			CK73FB1E223K	CHIP C 0.022UF K		

E: Scandinavia & Europe K: USA P: Canada W: Europe

U: PX(Far East, Hawaii) T: England M: Other Areas

UE: AAFES(Europe) X: Australia

 indicates safety critical components.

## PARTS LIST

× New Parts

Parts without Parts No. are not supplied.

Les articles non mentionnés dans le Parts No. ne sont pas fournis.

Teile ohne Parts No. werden nicht geliefert.

Ref. No. 参照番号	Address 位置	New Parts 新	Parts No. 部品番号	Description 部品名 / 規格	Desti- nation 仕向	Re- marks 備考
C79 -82			CK73EB1E683K	CHIP C 0.068UF K		
C83 ,84			CC73FSL1H221J	CHIP C 220PF J		
C85			CK73FB1E223K	CHIP C 0.022UF K		
C86			CK73FB1E103K	CHIP C 0.01UF K		
C87			CC73FCH1H220J	CHIP C 22PF J		
C88			CK73FB1E223K	CHIP C 0.022UF K		
C89			CC73FCH1H101J	CHIP C 100PF J		
C90			CK73FB1E223K	CHIP C 0.022UF K		
C91			CK73FB1E103K	CHIP C 0.01UF K		
C92			CC73FSL1H391J	CHIP C 390PF J		
C93			CK73FB1E223K	CHIP C 0.022UF K		
C94			CC73ECH1H202J	CHIP C 2000PF J		
C95			CK73FB1E153K	CHIP C 0.015UF K		
C96			CK73FB1E223K	CHIP C 0.022UF K		
C97			CC73FCH1H102J	CHIP C 1000PF J		
C98			CE04BW1E100M	NP-ELEC 10UF 25WV		
C99			CE04BW1H2R2M	ELECTRØ 2.2UF 50WV		
C100			C92-0004-05	CHIP TAN 1.0UF 16WV		
C101			CE04BW1H3R3M	ELECTRØ 3.3UF 50WV		
C102			C90-2045-05	ELECTRØ 2.2UF 25WV		
C103			CE04BW1H3R3M	ELECTRØ 3.3UF 50WV		
C104			CC73FCH1H101J	CHIP C 100PF J		
C105-107			CC73FCH1H331J	CHIP C 330PF J		
C108			CC73FSL1H182J	CHIP C 1800PF J		
C109			CK73FB1E153K	CHIP C 0.015UF K		
C110			CC73FSL1H182J	CHIP C 1800PF J		
C111			CK73FB1E223K	CHIP C 0.022UF K		
C112			CC73FCH1H101J	CHIP C 100PF J		
C113-114			CK73FB1E223K	CHIP C 0.022UF K		
C115			CK73FB1E223K	CHIP C 0.022UF K		
C116			CC73FCH1H102J	CHIP C 1000PF J		
C117			CK73FB1H472K	CHIP C 4700PF K		
C118			CK73FB1E223K	CHIP C 0.022UF K		
C119-122			CK73EB1E683K	CHIP C 0.068UF K		
C123			CE04BW1E100M	NP-ELEC 10UF 25WV		
C124			CC73FCH1H390J	CHIP C 39PF J		
C125			CC73FSL1H271J	CHIP C 270PF J		
C126			CE04BW1E220M	ELECTRØ 22UF 25WV		
C127			CK73FB1H102K	CHIP C 1000PF K		
C128			CK73FB1E103K	CHIP C 0.01UF K		
C129			CK73FB1E153K	CHIP C 0.015UF K		
C130			CK73FB1E103K	CHIP C 0.01UF K		
C131			C92-0004-05	CHIP TAN 1.0UF 16WV		
C132			CC73FSL1H471J	CHIP C 47PF J		
C133			CC73FSL1H221J	CHIP C 220PF J		
C140			CK73FB1E153K	CHIP C 0.015UF K		
C141			CK73FB1E223K	CHIP C 0.022UF K		
C142			CK73FB1H102K	CHIP C 1000PF K		
C143			CK73FB1E223K	CHIP C 0.022UF K		
C144			CE04EW1C471M	ELECTRØ 470UF 16WV		
C145			CK73FB1E223K	CHIP C 0.022UF K		
C146			CK73FB1H472K	CHIP C 4700PF K		
C147			C92-0001-05	CHIP-TAN 0.1UF 35WV		
C148			CK73FB1E103K	CHIP C 0.01UF K		
C149			CC73FCH1H330J	CHIP C 33PF J		

E: Scandinavia & Europe K: USA P: Canada W: Europe

U: PX(Far East, Hawaii) T: England M: Other Areas

UE : AAFES(Europe) X: Australia

 indicates safety critical components.

## PARTS LIST

※ New Parts

Parts without Parts No. are not supplied.

Les articles non mentionnés dans le Parts No. ne sont pas fournis.

Teile ohne Parts No. werden nicht geliefert.

Ref. No. 参照番号	Address 位置	New Parts 新	Parts No. 部品番号	Description 部品名 / 规格	Desti- nation 仕向	Re- marks 備考
C150,151			CC73FSL1H331J	CHIP C 330PF J		
C152			CK73FB1E223K	CHIP C 0.022UF K		
C153			CC73FCH1H060D	CHIP C 6PF D		
C154			CE04EW1E101M	ELECTRØ 100UF 25WV		
C155			CK73FB1E223K	CHIP C 0.022UF K		
C156,157			CC73FCH1H220J	CHIP C 22PF J		
C158,159			CK73FB1E223K	CHIP C 0.022UF K		
C160			CK73FB1H102K	CHIP C 1000PF K		
C161			CK73FB1E223K	CHIP C 0.022UF K		
C162,163			CK73FB1H102K	CHIP C 1000PF K		
C164			CK73EB1E563K	CHIP C 0.056UF K		
C165			CK73FB1H472K	CHIP C 4700PF K		
C166			CK73FB1E223K	CHIP C 0.022UF K		
C167			CK73FB1H102K	CHIP C 1000PF K		
C168			CC73FCH1H390J	CHIP C 39PF J		
C169			CC73FCH1H180J	CHIP C 18PF J		
C170			CC73FCH1H060D	CHIP C 6PF D		
C171			CC73FCH1H470J	CHIP C 47PF J		
C172			CE04EW1E101M	ELECTRØ 100UF 25WV		
C173			CK73FB1E223K	CHIP C 0.022UF K		
C174			CC73FCH1H030C	CHIP C 3PF C		
C175			CE04EW1C470M	ELECTRØ 47UF 16WV		
C176			CK73FB1E223K	CHIP C 0.022UF K		
C177,178			CK73FB1H102K	CHIP C 1000PF K		
C179			CE04EW1E101M	ELECTRØ 100UF 25WV		
C180			CK73EB1H104K	CHIP C 0.10UF K		
C181			CK73FB1E223K	CHIP C 0.022UF K		
C182			CE04EW1C470M	ELECTRØ 47UF 16WV		
C183			CK73FB1E223K	CHIP C 0.022UF K		
C184			CE04EW1C470M	ELECTRØ 47UF 16WV		
C185-188			CK73FB1E223K	CHIP C 0.022UF K		
C189			CE04EW1E331M	ELECTRØ 330UF 25WV		
C190			CK73EB1H104K	CHIP C 0.10UF K		
C191			CE04EW1C470M	ELECTRØ 47UF 16WV		
C193			CE04EW1C470M	ELECTRØ 47UF 16WV		
C194			CK73FB1E223K	CHIP C 0.022UF K		
C195			CE04EW1C470M	ELECTRØ 47UF 16WV		
C196			CK73FB1E223K	CHIP C 0.022UF K		
C197			CK73EB1H104K	CHIP C 0.10UF K		
C198			CK73FB1H102K	CHIP C 1000PF K		
C199,200			CK73FB1E223K	CHIP C 0.022UF K		
C201			CK73EB1H104K	CHIP C 0.10UF K		
C202-205			CK73FB1H102K	CHIP C 1000PF K		
C206-208			CK73FB1H221K	CHIP C 220PF K		
C209,210			CC73FCH1H150J	CHIP C 15PF J		
C211-235			CK73FB1H221K	CHIP C 220PF K		
C236,237			CC73FCH1H100D	CHIP C 10PF D		
C238-246			CK73FB1H221K	CHIP C 220PF K		
C247-251			CC73FSL1H101J	CHIP C 100PF J		
C252,253			CK73FB1E223K	CHIP C 0.022UF K		
C255-261			CK73FB1H102K	CHIP C 1000PF K		
TC1			C05-0370-05	TRIM CAP 20PF		
			E23-0159-05	TERMINAL		
			E23-0198-05	TERMINAL		

E: Scandinavia & Europe K: USA P: Canada W: Europe

U: PX(Far East, Hawaii) T: England M: Other Areas

UE: AAFES(Europe) X: Australia

 indicates safety critical components.

## PARTS LIST

\* New Parts

Parts without Parts No. are not supplied.

Les articles non mentionnés dans le Parts No. ne sont pas fournis.

Teile ohne Parts No. werden nicht geliefert.

Ref. No. 参照番号	Address 位置	New Parts 新	Parts No. 部品番号	Description 部品名 / 規格	Desti- nation 仕 向	Re- marks 備考
CN1			E40-0442-05	PIN CONNECTOR		
CN2			E40-3243-05	PIN ASSY(8P)		
CN3			E40-3239-05	PIN ASSY(4P)		
CN4			E40-3238-05	PIN ASSY(3P)		
CN5			E40-5067-05	PIN ASSY(10P)		
CN6			E40-3303-05	PIN ASSY(6P)		
CN7			E40-3239-05	PIN ASSY(4P)		
CN8 ,9			E40-3238-05	PIN ASSY(3P)		
CN10			E40-3303-05	PIN ASSY(6P)		
CN11			E40-3237-05	PIN ASSY(2P)		
CN12			E02-2018-05	IC SOCKET		
J1 ,2	2B		E06-0658-05	DIN SOCKET		
J3	2B		E06-1352-05	DIN SOCKET		
J4 ,5	2B		E13-0166-05	PHONE JACK		
80	2B		G02-0574-04	SPRING (X1)		
90	2A		J13-0055-15	FUSE HOLDER (X2)		
CF1			L72-0375-05	CERAMIC FILTER		
L1 ,2			L40-1225-29	SMALL FIXED INDUCTOR		
L3 ,4			L40-1035-29	SMALL FIXED INDUCTOR		
L5			L40-1225-29	SMALL FIXED INDUCTOR		
L6			L40-1201-17	SMALL FIXED INDUCTOR		
L7			L40-1001-17	SMALL FIXED INDUCTOR		
L8 ,9			L40-3311-14	SMALL FIXED INDUCTOR		
L10			L40-1011-17	SMALL FIXED INDUCTOR		
L11			L40-6891-17	SMALL FIXED INDUCTOR		
L12			L32-0198-05	OSCILLATING COIL		
L13 ,14			L40-1011-17	SMALL FIXED INDUCTOR		
L15			L40-1011-11	SMALL FIXED INDUCTOR		
L16 -22			L40-1001-17	SMALL FIXED INDUCTOR		
X1			L77-1403-05	CRYSTAL RESONATOR (10MHZ)		
X2		*	L77-1453-05	CRYSTAL RESONATOR (9.216MHZ)		
X3			L77-1408-05	CRYSTAL RESONATOR (25MHZ)		
CP1 ,2			R90-0721-05	MULTI-COMP 4.7K		
R1		*	RS14KB3F220J	FL-PROOF RS 22 J 3W		
R2			R92-1213-05	CARBON 100 J 1/2W		
R3 -5			RK73FB2A100J	CHIP R 10 J 1/10W		
R6			RK73FB2A470J	CHIP R 47 J 1/10W		
R7 -10			RK73FB2A100J	CHIP R 10 J 1/10W		
R11			RK73FB2A222J	CHIP R 2.2K J 1/10W		
R12			RK73FB2A104J	CHIP R 100K J 1/10W		
R13			RK73FB2A102J	CHIP R 1.0K J 1/10W		
R14			RK73FB2A183J	CHIP R 18K J 1/10W		
R15			RK73FB2A222J	CHIP R 2.2K J 1/10W		
R16			RK73FB2A472J	CHIP R 4.7K J 1/10W		
R17			RK73FB2A222J	CHIP R 2.2K J 1/10W		
R18			RK73FB2A472J	CHIP R 4.7K J 1/10W		
R19			RK73FB2A222J	CHIP R 2.2K J 1/10W		
R20			RK73FB2A392J	CHIP R 3.9K J 1/10W		
R21			RK73FB2A222J	CHIP R 2.2K J 1/10W		
R22			RK73FB2A392J	CHIP R 3.9K J 1/10W		
R23			RK73FB2A562J	CHIP R 5.6K J 1/10W		
R24			RK73FB2A123J	CHIP R 12K J 1/10W		

E: Scandinavia & Europe K: USA P: Canada W: Europe

U: PX(Far East, Hawaii) T: England M: Other Areas

UE: AAFES(Europe) X: Australia

 indicates safety critical components.

## PARTS LIST

\* New Parts

Parts without Parts No. are not supplied.

Les articles non mentionnés dans le Parts No. ne sont pas fournis.

Teile ohne Parts No. werden nicht geliefert.

Ref. No. 参照番号	Address 位置	New Parts 新	Parts No. 部品番号	Description 部品名 / 規格	Desti- nation 仕 向	Re- marks 備考
R25			RK73FB2A393J	CHIP R 39K J 1/10W		
R26			RK73FB2A562J	CHIP R 5.6K J 1/10W		
R27			RK73FB2A182J	CHIP R 1.8K J 1/10W		
R28 ,29			RK73FB2A273J	CHIP R 27K J 1/10W		
R30			RK73FB2A822J	CHIP R 8.2K J 1/10W		
R31			RK73FB2A682J	CHIP R 6.8K J 1/10W		
R32			RK73FB2A473J	CHIP R 47K J 1/10W		
R33			RK73FB2A222J	CHIP R 2.2K J 1/10W		
R34			RK73FB2A472J	CHIP R 4.7K J 1/10W		
R35			RK73FB2A153J	CHIP R 15K J 1/10W		
R36			RK73FB2A562J	CHIP R 5.6K J 1/10W		
R37			RK73FB2A682J	CHIP R 6.8K J 1/10W		
R38			RK73FB2A333J	CHIP R 33K J 1/10W		
R39			RK73FB2A223J	CHIP R 22K J 1/10W		
R40			RK73FB2A153J	CHIP R 15K J 1/10W		
R41			RK73FB2A104J	CHIP R 100K J 1/10W		
R42			RK73FB2A103J	CHIP R 10K J 1/10W		
R43			RK73FB2A472J	CHIP R 4.7K J 1/10W		
R44			RK73FB2A103J	CHIP R 10K J 1/10W		
R45			RK73FB2A183J	CHIP R 18K J 1/10W		
R46			RK73FB2A822J	CHIP R 8.2K J 1/10W		
R47			RK73FB2A183J	CHIP R 18K J 1/10W		
R48			RK73FB2A822J	CHIP R 8.2K J 1/10W		
R49			RK73FB2A470J	CHIP R 47 J 1/10W		
R50 ,51			RK73FB2A561J	CHIP R 560 J 1/10W		
R52			RK73FB2A684J	CHIP R 680K J 1/10W		
R53			RK73FB2A273J	CHIP R 27K J 1/10W		
R54			RK73FB2A101J	CHIP R 100 J 1/10W		
R55 ,56			RK73FB2A222J	CHIP R 2.2K J 1/10W		
R57			RK73FB2A101J	CHIP R 100 J 1/10W		
R58 ,59			RK73FB2A222J	CHIP R 2.2K J 1/10W		
R60 -63			RK73FB2A332J	CHIP R 3.3K J 1/10W		
R64			RK73FB2A100J	CHIP R 10 J 1/10W		
R65			RK73FB2A103J	CHIP R 10K J 1/10W		
R66			RK73FB2A102J	CHIP R 1.0K J 1/10W		
R67			RK73FB2A222J	CHIP R 2.2K J 1/10W		
R68			RK73FB2A104J	CHIP R 100K J 1/10W		
R69 ,70			RK73FB2A271J	CHIP R 270 J 1/10W		
R72			RK73FB2A822J	CHIP R 8.2K J 1/10W		
R73			RK73FB2A103J	CHIP R 10K J 1/10W		
R74			RK73FB2A105J	CHIP R 1.0M J 1/10W		
R75 ,76			RK73FB2A181J	CHIP R 180 J 1/10W		
R77 -80			RK73FB2A103J	CHIP R 10K J 1/10W		
R81 ,82			RK73FB2A332J	CHIP R 3.3K J 1/10W		
R83			RK73FB2A152J	CHIP R 1.5K J 1/10W		
R84 -88			RK73FB2A103J	CHIP R 10K J 1/10W		
R89			RK73FB2A122J	CHIP R 1.2K J 1/10W		
R90			RK73FB2A102J	CHIP R 1.0K J 1/10W		
R91			RK73FB2A470J	CHIP R 47 J 1/10W		
R92			RK73FB2A102J	CHIP R 1.0K J 1/10W		
R93			RK73FB2A222J	CHIP R 2.2K J 1/10W		
R94 ,95			RK73FB2A102J	CHIP R 1.0K J 1/10W		
R96			RK73FB2A222J	CHIP R 2.2K J 1/10W		
R97 ,98			RK73FB2A102J	CHIP R 1.0K J 1/10W		
R99			RK73FB2A101J	CHIP R 100 J 1/10W		

E: Scandinavia & Europe K: USA P: Canada W: Europe

U: PX(Far East, Hawaii) T: England M: Other Areas

UE: AAFES(Europe) X: Australia

 indicates safety critical components.



## PARTS LIST

\* New Parts

Parts without Parts No. are not supplied.

Les articles non mentionnés dans le Parts No. ne sont pas fournis.

Teile ohne Parts No. werden nicht geliefert.

Ref. No. 参照番号	Address 位置	New Parts 新	Parts No. 部品番号	Description 部品名 / 規格	Desti- nation 仕 向	Re- marks 備考
R100			RK73FB2A222J	CHIP R 2.2K J 1/10W		
R101			RK73FB2A470J	CHIP R 47 J 1/10W		
R102			RK73FB2A122J	CHIP R 1.2K J 1/10W		
R103			RK73FB2A152J	CHIP R 1.5K J 1/10W		
R104			RK73FB2A153J	CHIP R 15K J 1/10W		
R105			RK73FB2A222J	CHIP R 2.2K J 1/10W		
R106			RK73FB2A220J	CHIP R 22 J 1/10W		
R107			RK73FB2A222J	CHIP R 2.2K J 1/10W		
R108			RK73FB2A100J	CHIP R 10 J 1/10W		
R109, 110		*	R92-2063-05	680 J 1/2W		
R111			RK73FB2A103J	CHIP R 10K J 1/10W		
R112			RK73FB2A472J	CHIP R 4.7K J 1/10W		
R113			RK73FB2A562J	CHIP R 5.6K J 1/10W		
R114			RK73FB2A123J	CHIP R 12K J 1/10W		
R115			RK73FB2A393J	CHIP R 39K J 1/10W		
R116			RK73FB2A562J	CHIP R 5.6K J 1/10W		
R117			RK73FB2A182J	CHIP R 1.8K J 1/10W		
R118, 119			RK73FB2A273J	CHIP R 27K J 1/10W		
R120			RK73FB2A822J	CHIP R 8.2K J 1/10W		
R121			RK73FB2A682J	CHIP R 6.8K J 1/10W		
R122			RK73FB2A473J	CHIP R 47K J 1/10W		
R123			RK73FB2A222J	CHIP R 2.2K J 1/10W		
R124			RK73FB2A472J	CHIP R 4.7K J 1/10W		
R125			RK73FB2A153J	CHIP R 15K J 1/10W		
R126			RK73FB2A562J	CHIP R 5.6K J 1/10W		
R127			RK73FB2A682J	CHIP R 6.8K J 1/10W		
R128			RK73FB2A333J	CHIP R 33K J 1/10W		
R129			RK73FB2A223J	CHIP R 22K J 1/10W		
R130			RK73FB2A153J	CHIP R 15K J 1/10W		
R131			RK73FB2A104J	CHIP R 100K J 1/10W		
R132			RK73FB2A222J	CHIP R 2.2K J 1/10W		
R133			RK73FB2A472J	CHIP R 4.7K J 1/10W		
R134			RK73FB2A561J	CHIP R 560 J 1/10W		
R135			RK73FB2A153J	CHIP R 15K J 1/10W		
R136, 137			RK73FB2A103J	CHIP R 10K J 1/10W		
R138			RK73FB2A101J	CHIP R 100 J 1/10W		
R139			RK73FB2A184J	CHIP R 180K J 1/10W		
R140			RK73FB2A102J	CHIP R 1.0K J 1/10W		
R141, 142			RK73FB2A103J	CHIP R 10K J 1/10W		
R143			RK73FB2A331J	CHIP R 330 J 1/10W		
R144			RK73FB2A470J	CHIP R 47 J 1/10W		
R145			RK73FB2A221J	CHIP R 220 J 1/10W		
R146			RK73FB2A471J	CHIP R 470 J 1/10W		
R147, 148			RK73FB2A153J	CHIP R 15K J 1/10W		
R149			RK73FB2A101J	CHIP R 100 J 1/10W		
R150			RK73FB2A681J	CHIP R 680 J 1/10W		
R151			RK73FB2A101J	CHIP R 100 J 1/10W		
R152			RK73FB2A184J	CHIP R 180K J 1/10W		
R153			RK73FB2A182J	CHIP R 1.8K J 1/10W		
R154			RK73FB2A101J	CHIP R 100 J 1/10W		
R155			RK73FB2A184J	CHIP R 180K J 1/10W		
R156			RK73FB2A221J	CHIP R 220 J 1/10W		
R157			RK73FB2A182J	CHIP R 1.8K J 1/10W		
R158			RK73FB2A101J	CHIP R 100 J 1/10W		
R159			RK73FB2A333J	CHIP R 33K J 1/10W		

E: Scandinavia & Europe K: USA P: Canada W: Europe

U: PX(Far East, Hawaii) T: England M: Other Areas

UE: AAFES(Europe) X: Australia

 indicates safety critical components.

## PARTS LIST

\* New Parts

Parts without Parts No. are not supplied.

Les articles non mentionnés dans le Parts No. ne sont pas fournis.

Teile ohne Parts No. werden nicht geliefert.

Ref. No. 参照番号	Address 位置	New Parts 新	Parts No. 部品番号	Description 部品名/規格	Desti- nation 仕向	Re- marks 備考
R160			RK73FB2A223J	CHIP R 22K J 1/10W		
R161			RK73FB2A222J	CHIP R 2.2K J 1/10W		
R162			RK73FB2A101J	CHIP R 100 J 1/10W		
R163-164			RK73FB2A103J	CHIP R 10K J 1/10W		
R165			RK73FB2A222J	CHIP R 2.2K J 1/10W		
R166			RK73FB2A100J	CHIP R 10 J 1/10W		
R167			RK73FB2A100J	CHIP R 10 J 1/10W		
R168			RK73FB2A102J	CHIP R 1.0K J 1/10W		
R170			RK73FB2A222J	CHIP R 2.2K J 1/10W		
R171			RK73FB2A223J	CHIP R 22K J 1/10W		
R172-175			RK73FB2A103J	CHIP R 10K J 1/10W		
R176			RK73FB2A182J	CHIP R 1.8K J 1/10W		
R177			RK73FB2A101J	CHIP R 100 J 1/10W		
R178			RK73FB2A472J	CHIP R 4.7K J 1/10W		
R179			RK73FB2A153J	CHIP R 15K J 1/10W		
R180			RK73FB2A473J	CHIP R 47K J 1/10W		
R181			RK73FB2A221J	CHIP R 220 J 1/10W		
R182			RK73FB2A152J	CHIP R 1.5K J 1/10W		
R183, 184			RK73FB2A103J	CHIP R 10K J 1/10W		
R185			RK73FB2A334J	CHIP R 330K J 1/10W		
R186			RK73FB2A151J	CHIP R 150 J 1/10W		
R187			RK73FB2A470J	CHIP R 47 J 1/10W		
R188			RK73FB2A223J	CHIP R 22K J 1/10W		
R189			RK73FB2A273J	CHIP R 27K J 1/10W		
R190			RK73FB2A470J	CHIP R 47 J 1/10W		
R191			RK73FB2A102J	CHIP R 1.0K J 1/10W		
R192			RK73FB2A470J	CHIP R 47 J 1/10W		
R193			RK73FB2A221J	CHIP R 220 J 1/10W		
R194			RK73FB2A470J	CHIP R 47 J 1/10W		
R195			RK73FB2A100J	CHIP R 10 J 1/10W		
R196			RK73FB2A104J	CHIP R 100K J 1/10W		
R197			RK73FB2A102J	CHIP R 1.0K J 1/10W		
R198			RK73FB2A101J	CHIP R 100 J 1/10W		
R199			RK73FB2A472J	CHIP R 4.7K J 1/10W		
R200			RK73FB2A101J	CHIP R 100 J 1/10W		
R201			RK73FB2A103J	CHIP R 10K J 1/10W		
R202			RK73FB2A101J	CHIP R 100 J 1/10W		
R203-205			RK73FB2A100J	CHIP R 10 J 1/10W		
R206-212			RK73FB2A472J	CHIP R 4.7K J 1/10W		
R213-223			RK73FB2A103J	CHIP R 10K J 1/10W		
R224-227			RK73FB2A101J	CHIP R 100 J 1/10W		
R228, 229			RK73FB2A332J	CHIP R 3.3K J 1/10W		
R230-233			RK73FB2A102J	CHIP R 1.0K J 1/10W		
R234, 235			RK73FB2A332J	CHIP R 3.3K J 1/10W		
R236, 237			RK73FB2A472J	CHIP R 4.7K J 1/10W		
R238			RK73FB2A183J	CHIP R 18K J 1/10W		
R239			RK73FB2A123J	CHIP R 12K J 1/10W		
R240			RK73FB2A184J	CHIP R 180K J 1/10W		
R241			RK73FB2A470J	CHIP R 47 J 1/10W		
R242			RK73FB2A182J	CHIP R 1.8K J 1/10W		
R243			RK73FB2A101J	CHIP R 100 J 1/10W		
R244			RK73FB2A222J	CHIP R 2.2K J 1/10W		
R245			RK73FB2A103J	CHIP R 10K J 1/10W		
VR1	2A	*	R05-3461-05	POTENTIOMETER 10K-A		
VR2	2A	*	R05-2403-05	POTENTIOMETER 1K-B		

E: Scandinavia & Europe K: USA P: Canada W: Europe

U: PX(Far East, Hawaii) T: England M: Other Areas

UE: AAFES(Europe) X: Australia

 indicates safety critical components.

## PARTS LIST

\* New Parts

Parts without Parts No. are not supplied.

Les articles non mentionnés dans le Parts No. ne sont pas fournis.

Teile ohne Parts No. werden nicht geliefert.

Ref. No. 参照番号	Address 位置	New Parts 新	Parts No. 部品番号	Description 部品名/規格	Desti- nation 仕向	Re- marks 備考
VR3		*	R12-1086-05	TRIMMING POT. 2.2K		
S1 ,2	2B		S29-1442-05	ROTARY SWITCH		
S3 -5			S40-2440-15	PUSH SWITCH		
S6	2B	*	S79-0403-05	SWITCH (10P-DIP)		
S7			S31-1411-05	SLIDE SWITCH (1-2)		
S8			S31-2420-05	SLIDE SWITCH (2-2)		
D1 ,2			S1WB10	DIODE		
D3			1SS226	DIODE		
D4 -6		*	RD4.3M-B2	DIODE		
D7			1SV205	DIODE		
D8			1SS226	DIODE		
D9			1SV166	DIODE		
D10			1SS272	DIODE		
D11			1SS226	DIODE		
D12 -14			1SS272	DIODE		
IC1			UPC7815H	IC		
IC2			UPC7912HF	IC(VOLTAGE REGULATOR/ -12V)		
IC3			UPC7805H	IC(VOLTAGE REGULATOR/ +5V)		
IC4			UPC79M05HF	IC(VOLTAGE REGULATOR/+5V)		
IC5		*	NJM5532M	IC		
IC6			NJM4560M	IC(OP AMP X2)		
IC7 ,8			MC74HC4052F	IC(HPF)		
IC9			NJM4560M	IC(OP AMP X2)		
IC10			MC74HC4052F	IC(HPF)		
IC11		*	KCE05	IC		
IC12			NJM4560M	IC(OP AMP X2)		
IC13		*	NJM5532M	IC		
IC14		*	UPD74HCT00G	IC		
IC15, 16			NJM072BM	IC(SAMPLE/HOLD AMP)		
IC17			PCM78AP	IC(DA CONVERTER)		
IC18			UPD74HCT00G	IC		
IC19			TC74HC74AF	IC(DUAL D-TYPE FLIP FLOP)		
IC20			PCM56P	IC(D/A CONVERTER)		
IC21			MC74HC4053F	IC(ANALOG SW)		
IC22			LM6361M	IC(BUFF)		
IC23			MC74HC4053F	IC(ANALOG SW)		
IC24		*	NJM5532M	IC		
IC25			MC74HC4053F	IC(ANALOG SW)		
IC26		*	KCE05	IC		
IC27, 28			MC74HC4053F	IC(ANALOG SW)		
IC29			NJM4560M	IC(OP AMP X2)		
IC30			MC74HC4053F	IC(ANALOG SW)		
IC31			YM6631	IC		
IC32			MC145688CP	IC(PLL)		
IC33			MS4460L	IC(PRE SCALER)		
IC34			NJM78L08UA	IC(VOLTAGE REGULATOR/ +8V)		
IC35			CXD1225M	IC(PLL SYNTHESIZER)		
IC36			UPC7805H	IC(VOLTAGE REGULATOR/ +5V)		
IC37		*	647180X0FS6JBR2	IC		
IC38		*	TC74ACT540F	IC		
IC39		*	TMS320E15J-JBS1	IC(DIGITAL SIGNAL PROCESSOR)		
IC40			UPD65012GF-350	IC(GATE ARRAY)		
IC41		*	UPD74HCT00G	IC		
IC42			S-8054ALR-LN	IC		

E: Scandinavia & Europe K: USA P: Canada W: Europe

U: PX(Far East, Hawaii) T: England M: Other Areas

UE: AAFES(Europe) X: Australia

 indicates safety critical components.

# DSP-100

## PARTS LIST

\* New Parts

Parts without Parts No. are not supplied.

Les articles non mentionnés dans le Parts No. ne sont pas fournis.

Teile ohne Parts No. werden nicht geliefert.

Ref. No. 参照番号	Address 位置	New Parts 新	Parts No. 部品番号	Description 部品名 / 規格	Desti- nation 仕向	Re- marks 備考
IC43			TC74HC86AF	IC		
IC44			S-8054HN-CB	IC		
Q1		*	2SC2412K(S)	TRANSISTOR		
Q2 ,3			2SK508NV(K53)	FET		
Q4		*	2SC2412K(S)	TRANSISTOR		
Q5			2SK508NV(K53)	FET		
Q6 ,7		*	2SC2412K(S)	TRANSISTOR		
Q8			2SC2954(QK)	TRANSISTOR		
Q9 -11			2SC2412K(R)	TRANSISTOR		
Q12			2SC2714(Y)	TRANSISTOR		
Q13 -16			2SC2412K(R)	TRANSISTOR		
Q17 -19			2SC3324(G)	TRANSISTOR		
Q20			2SK210(GR)	FET		
Q21 ,22			2SC2714(Y)	TRANSISTOR		
Q23 -26			DTC144EK	DIGITAL TRANSISTOR		
Q27			2SC2714(Y)	TRANSISTOR		
Q28			DTC144EK	DIGITAL TRANSISTOR		
Q29			2SD1757K	TRANSISTOR		

E: Scandinavia & Europe K: USA P: Canada W: Europe

U: PX(Far East, Hawaii) T: England M: Other Areas

UE: AAFES(Europe) X: Australia

 indicates safety critical components.

## EXPLODED VIEW

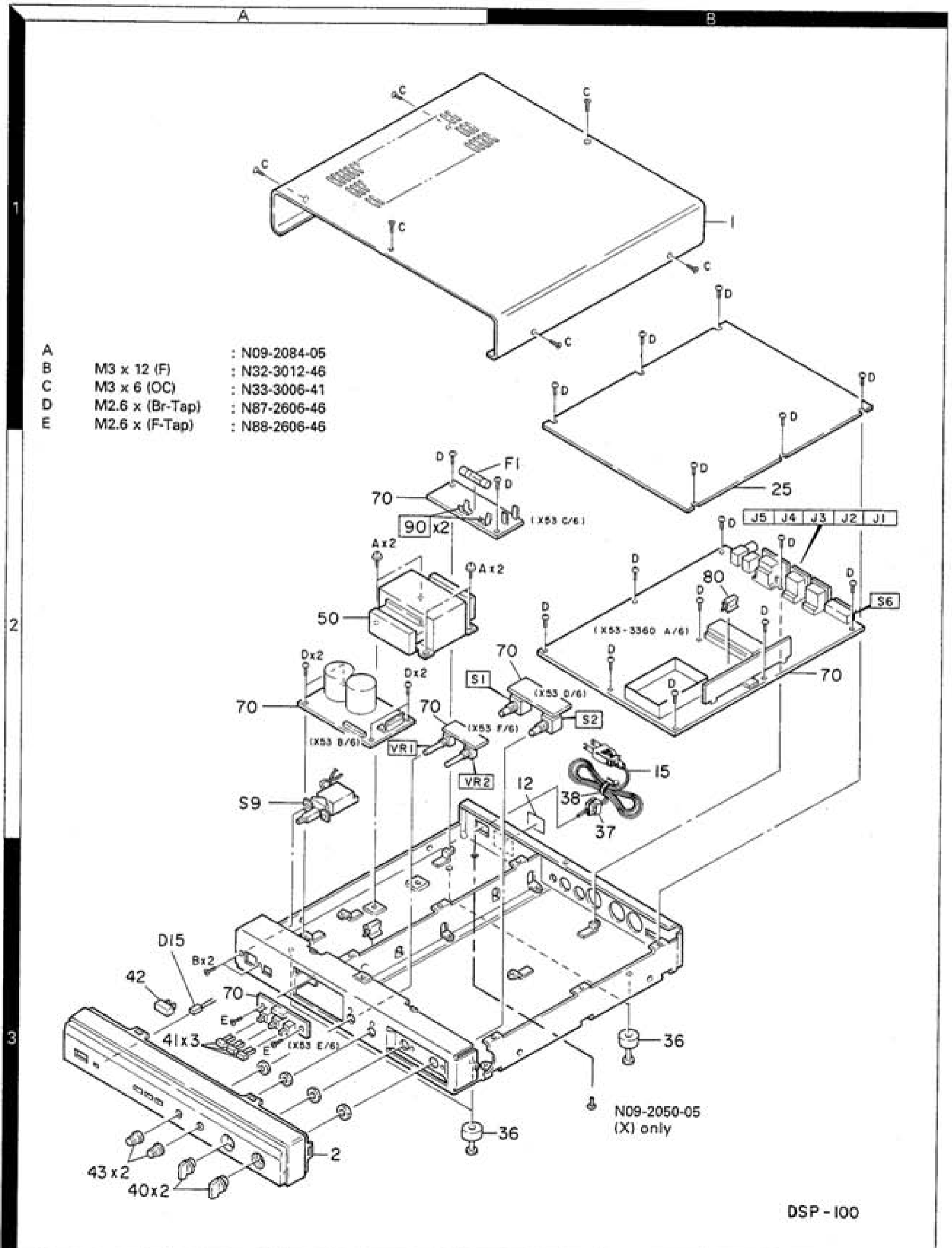

DSP - 100

## PACKING

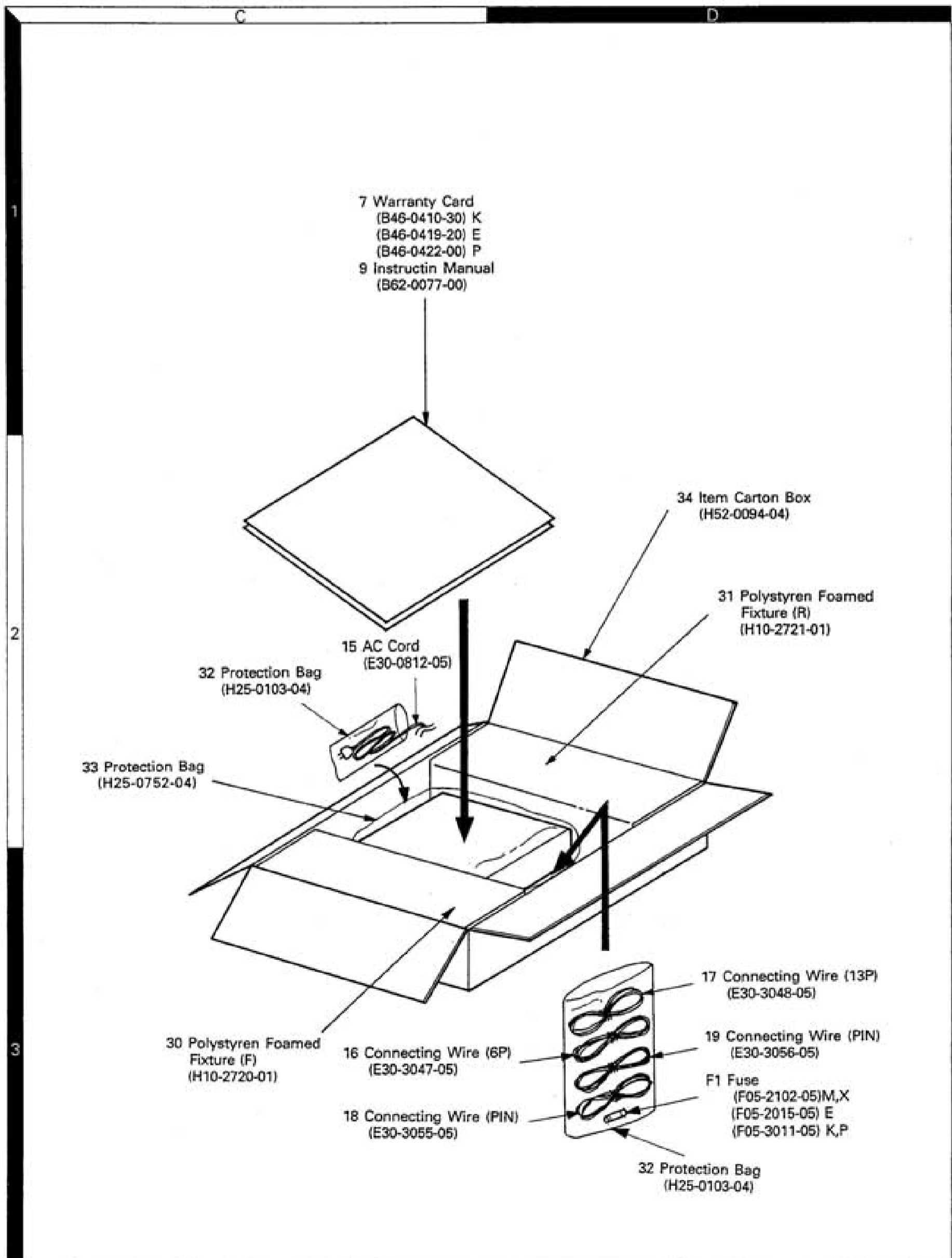

## ADJUSTMENT

Item	Condition	Measurement			Adjustment			Specifications/Remarks
		Test-equipment	Unit	Terminal	Unit	Parts	Method	
1. Initialize setting	1) TS-850's POWER SW : ON Display f. : 14.000MHz MODE : USB							
	2) DSP-100's Front pane RX : ON TX : ON CW : FAST CAR LEVEL : Fully CW MIC GAIN : Fully CW FILTER (HPF) : 100 FILTER (LPF) : 3100 Rear panel DIP switch : All ON TX GAIN : Fully CW PC board S7, S8 : 10K side							
2. Connection	1) TS-850 Cable DSP-100 DSP3 ← 13P DIN → DSP3 ACC1 ← 6P DIN → CONT. IN							
3. PLL lock voltage (1)	1) DSP-100' POWER SW : ON	DC V.M	DSP	TP5	DSP	TC1	3.6V	±0.1V
4. PLL lock voltage (2)				TP6		L12	4.0V	±0.1V
5. DBC check (1)				DBC			Check	0.6V or less
6. DBC check (2)				DBC			Check	4 to 5V
	2) S8 : 10M side After adjustment S8 : 10K side							

After adjustment knobs and switches should be set as follows.

POWER : OFF      CAR VR : MIN  
 HPF : 200      MIC VR : MIN  
 LPF : 2750      Push switches : OFF  
 DIP switches : ON

# DSP-100

## ADJUSTMENT

### Front Panel

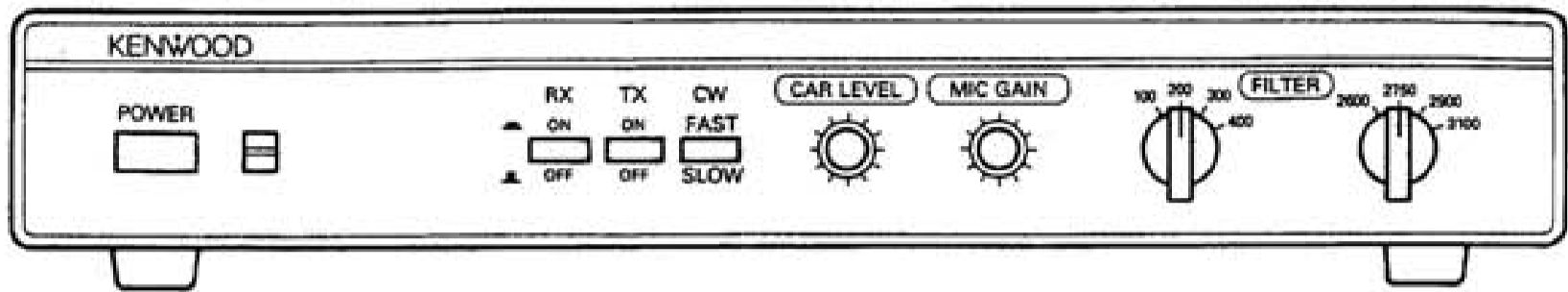

### Rear Panel

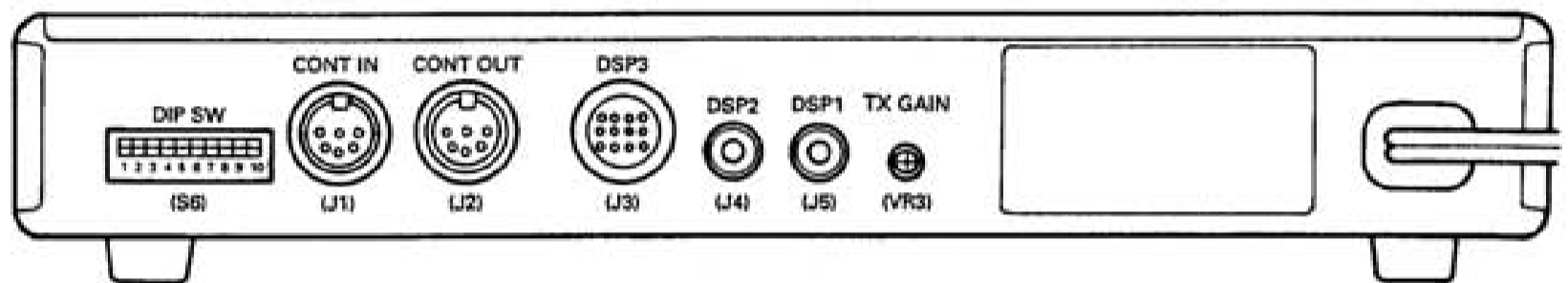

### Adjustment Points

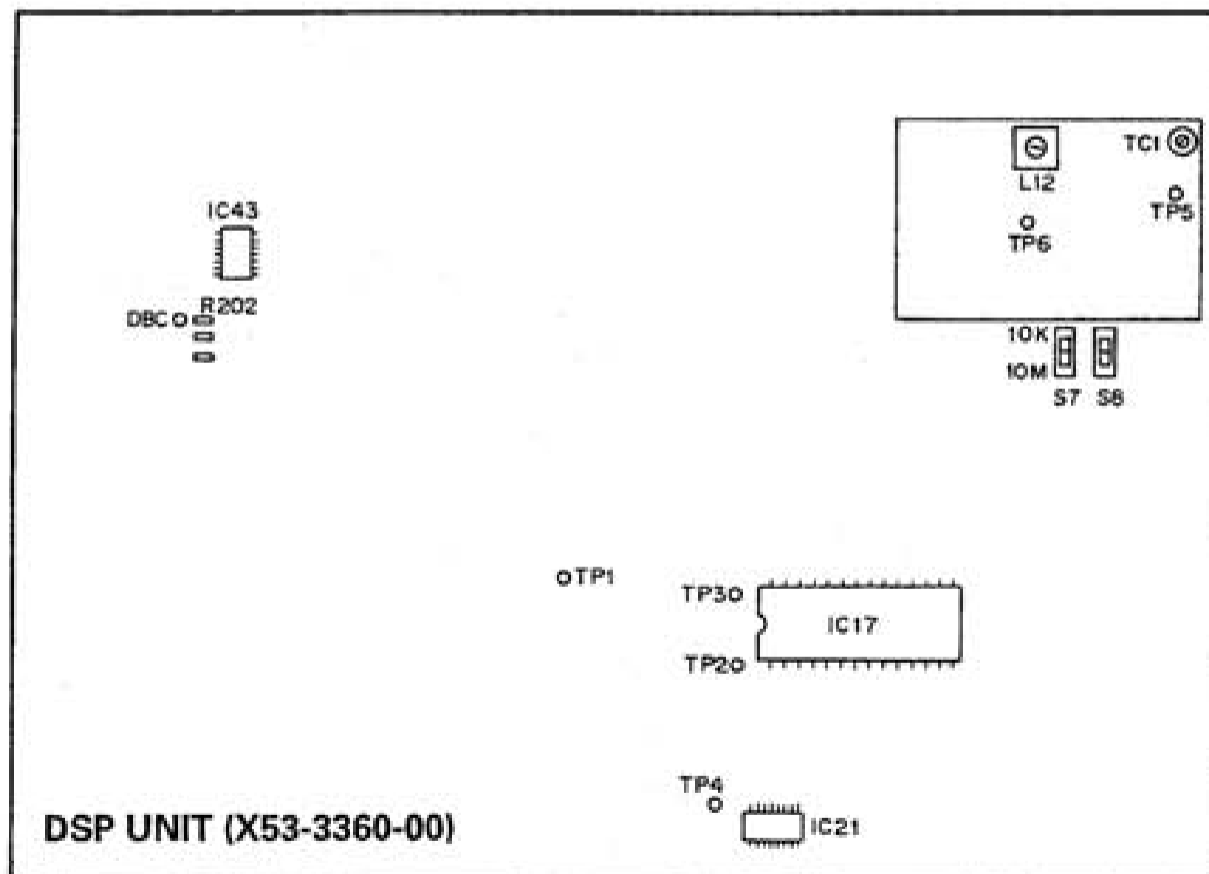





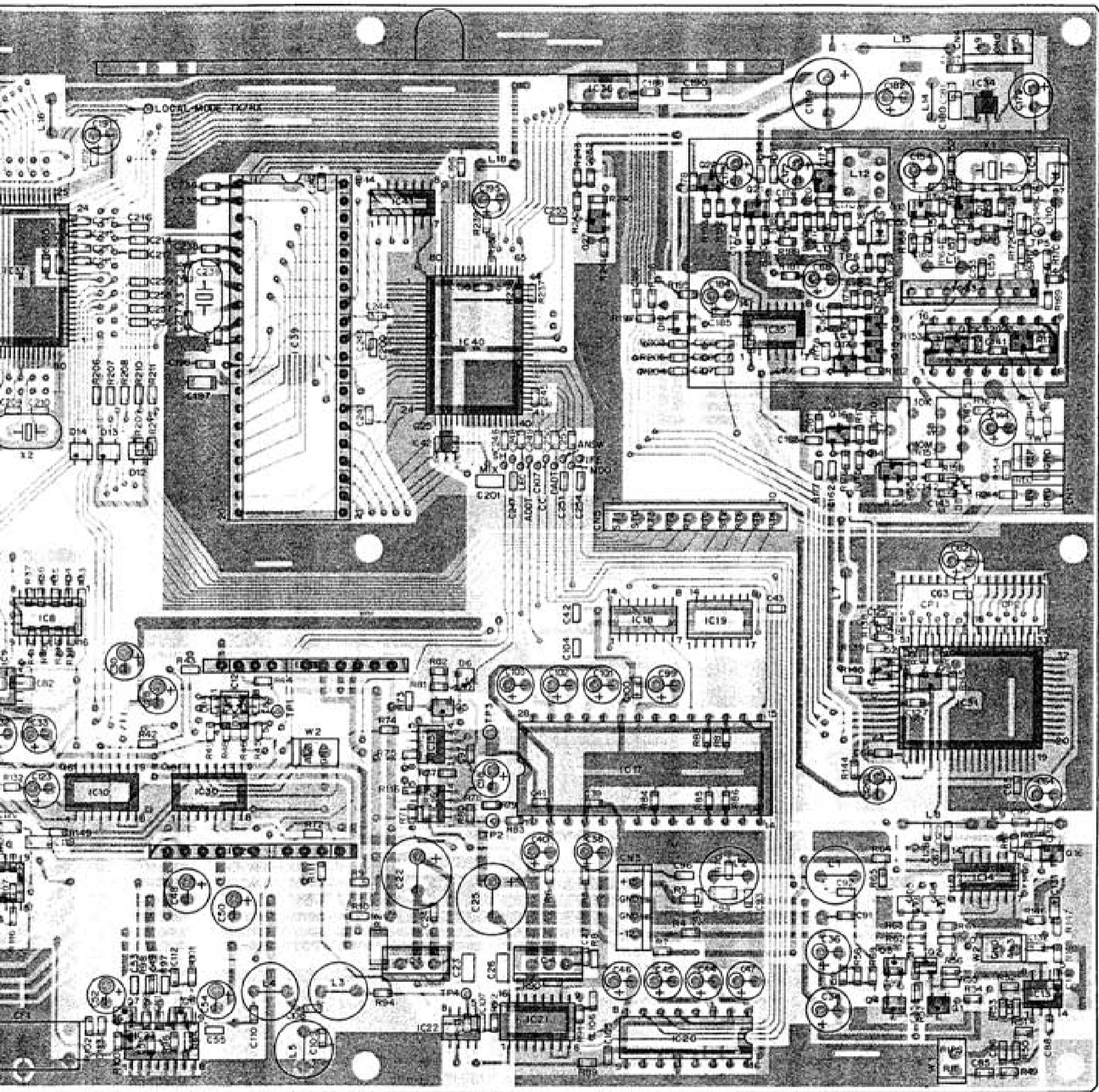

DSP UNIT (X53-3360-00) Foil side view

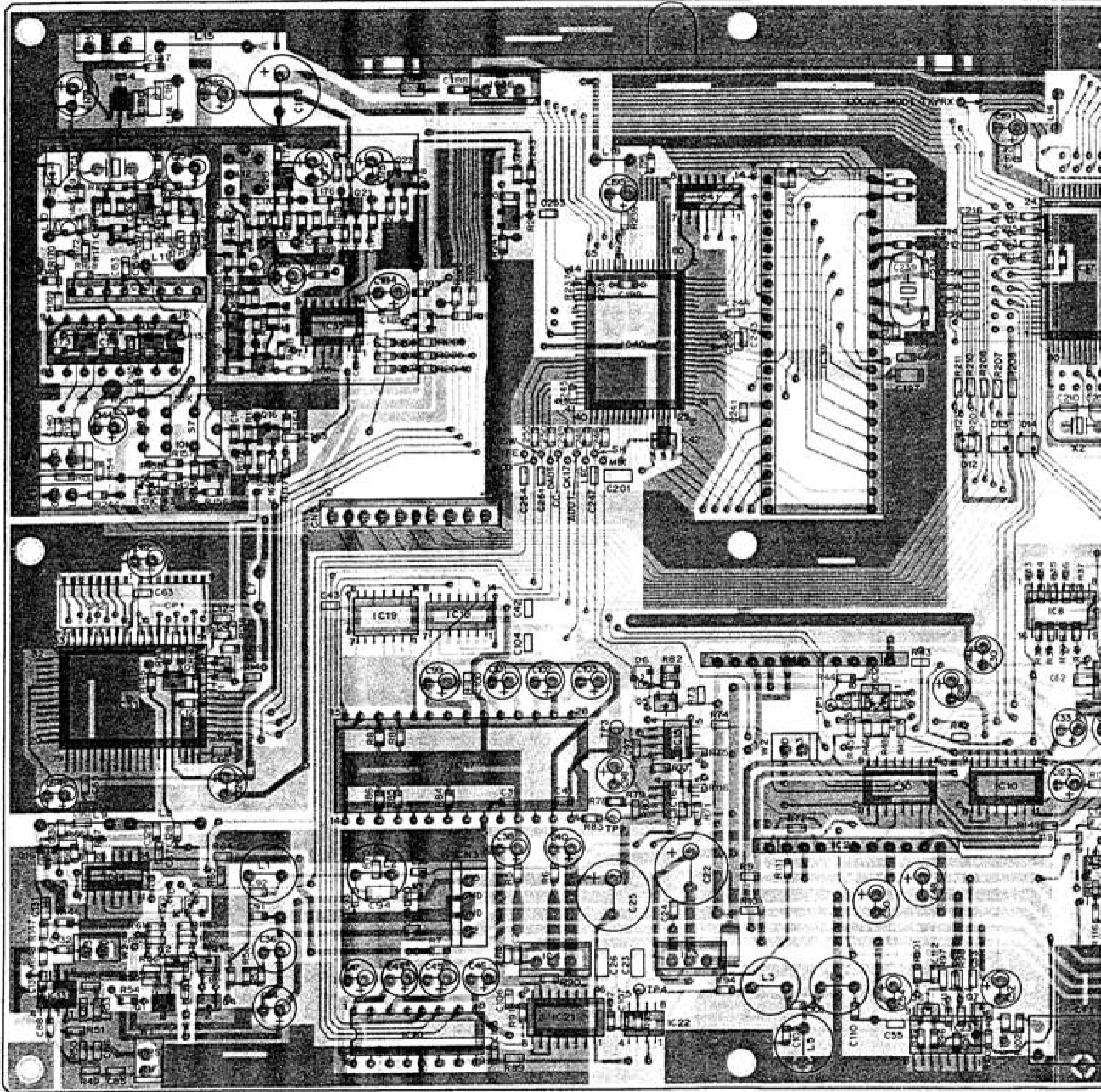

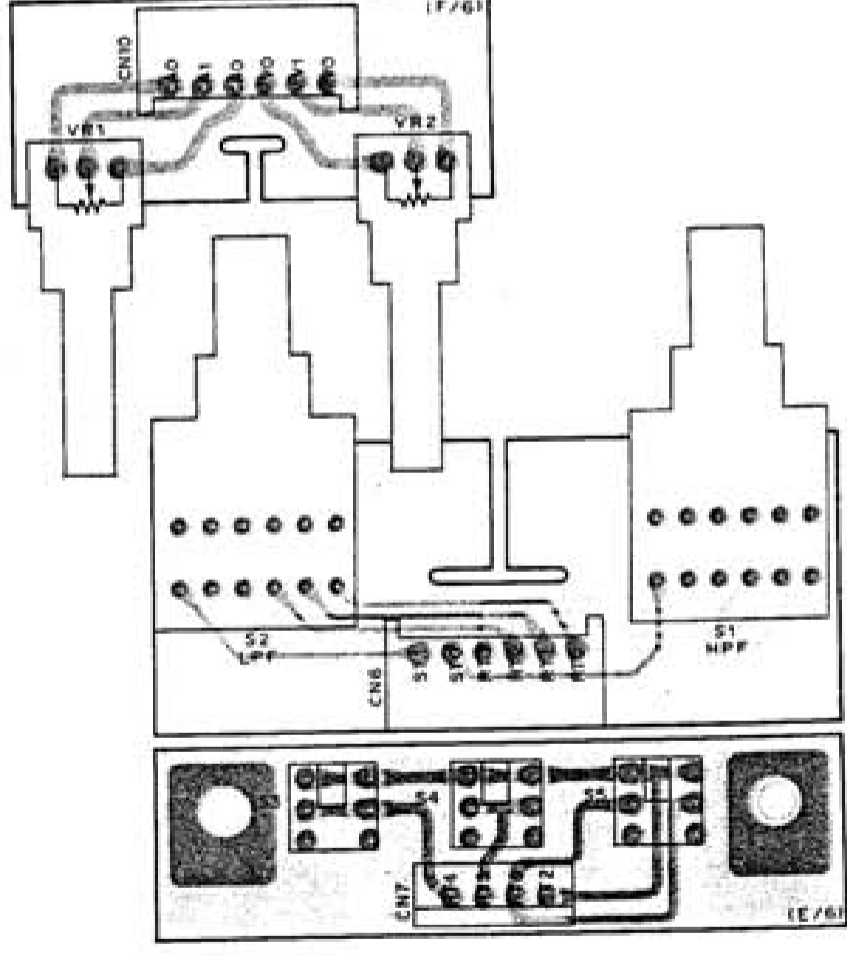
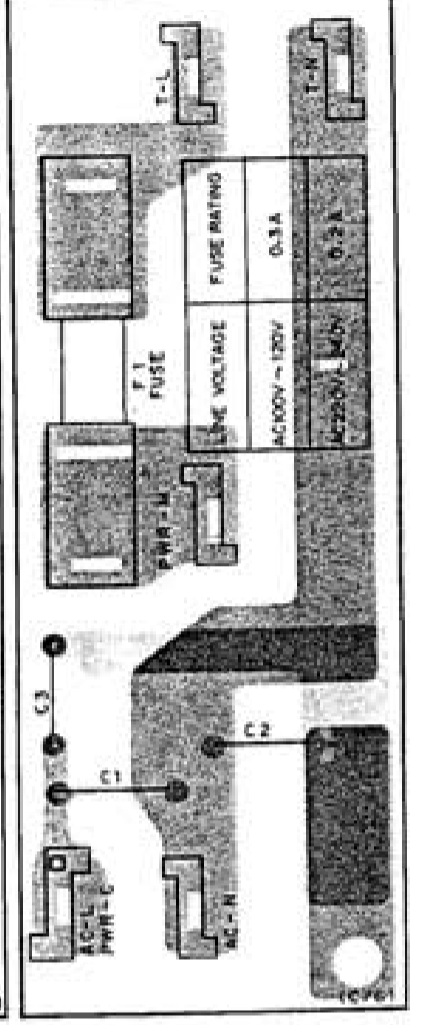
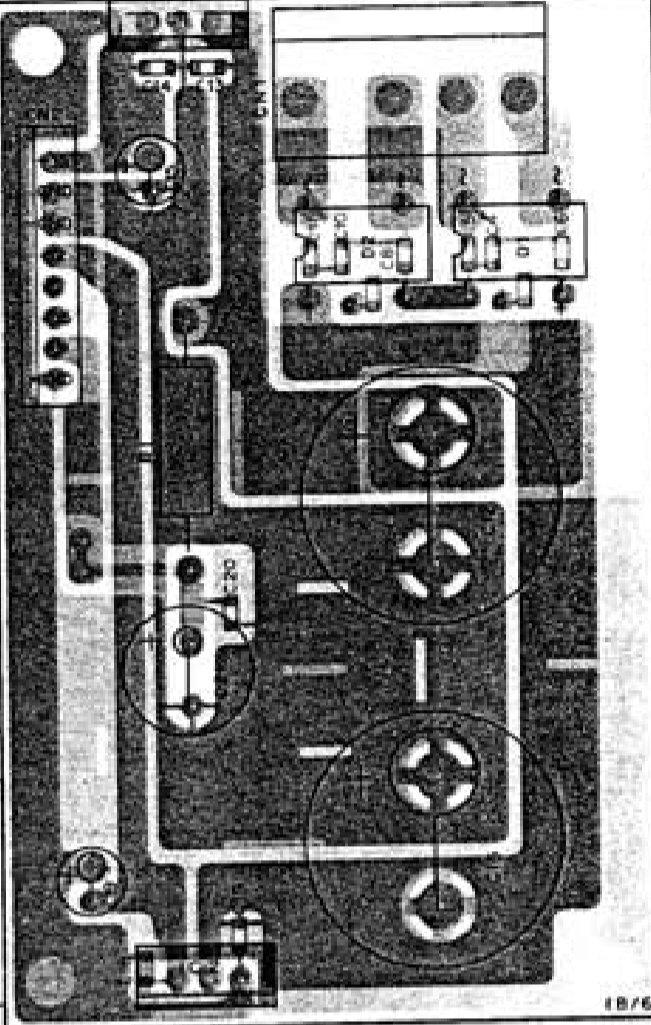
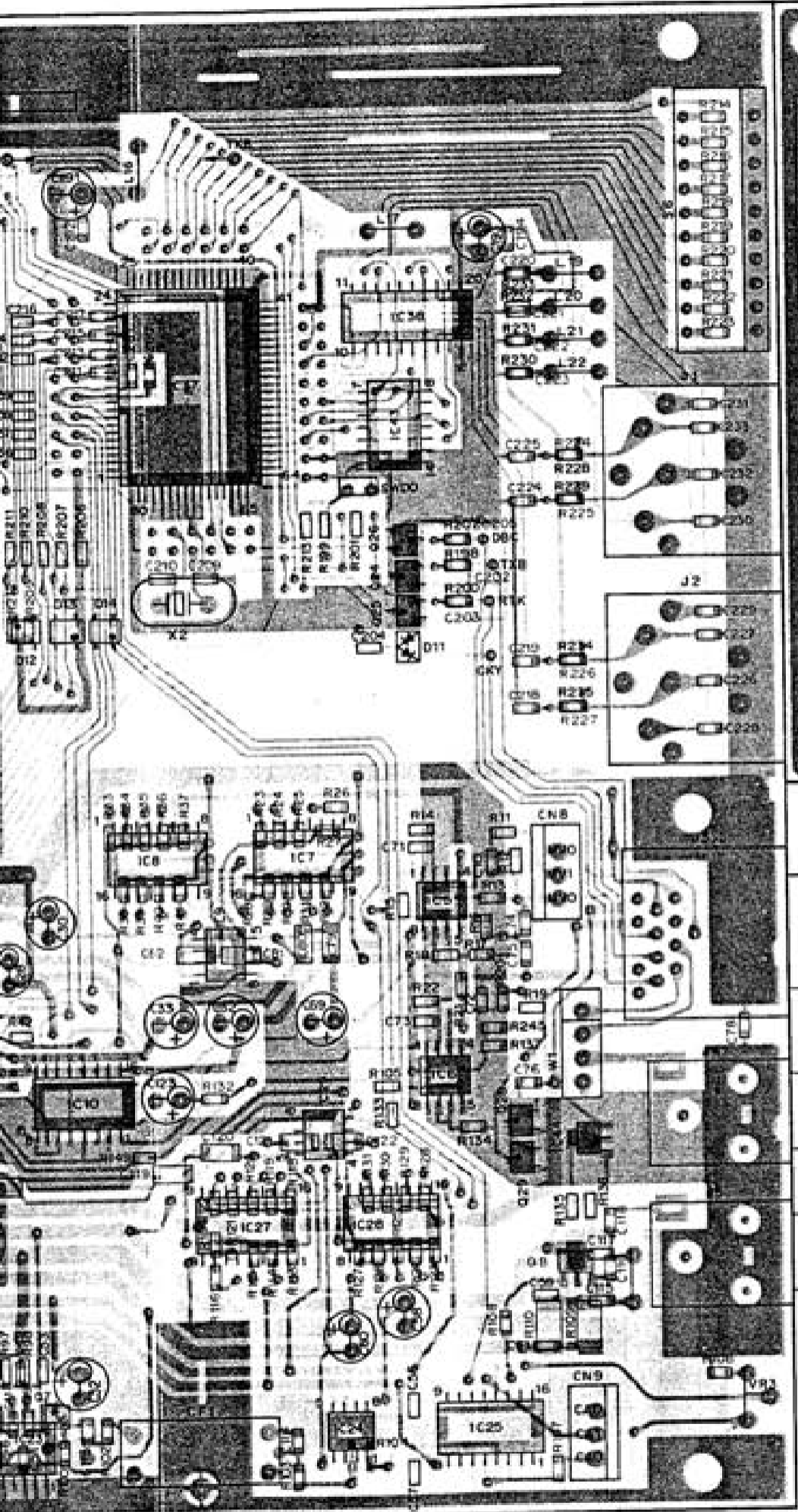

# PC BOARD VIEWS DSP-100

DTC114EK  
2SC2412K  
2SC2714  
2SC3324  
2SD1757K

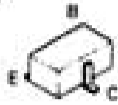

NJM072BM



2SK210

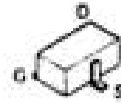

2SC2954



NJM4560M  
NJM5532M

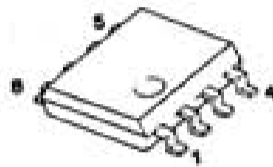

2SK508NV

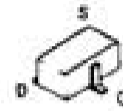

PCM56P  
MC14568BCP

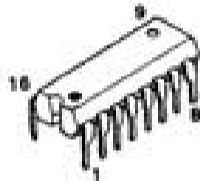

MC74HC4052F  
MC74HC4053F  
TC74HC74AF

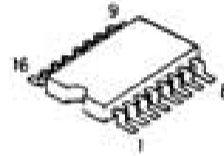

PCM78AP

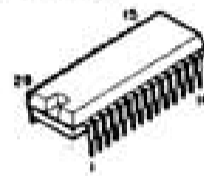

CXD1225M  
 $\mu$ PD74HC00G

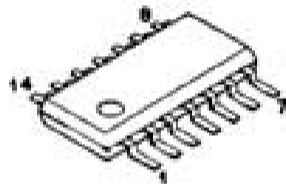

$\mu$ PC7805H  
 $\mu$ PC7815H

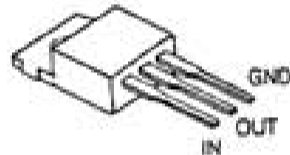

647180XOFS6JBR2  
 $\mu$ PD65012GF-350

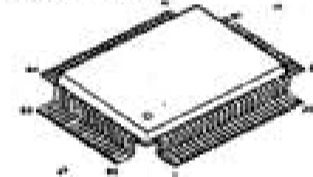

M54460L

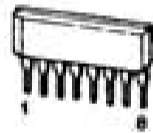

S-8054ALR-LN



LM6361M

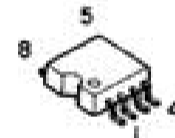

$\mu$ PC7912HF



NJM78L08UA



S-8054HN-CB



KCE05

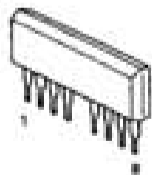

TC74ACT540F

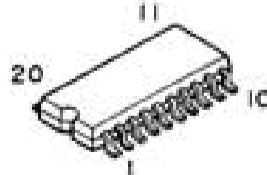

TMS320E15J-JBS1



YM6631

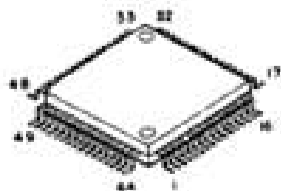

TC74HC86AF



$\mu$ PC79M05HF

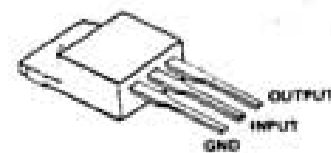

# DSP-100 SCHEMATIC DIAGRAM

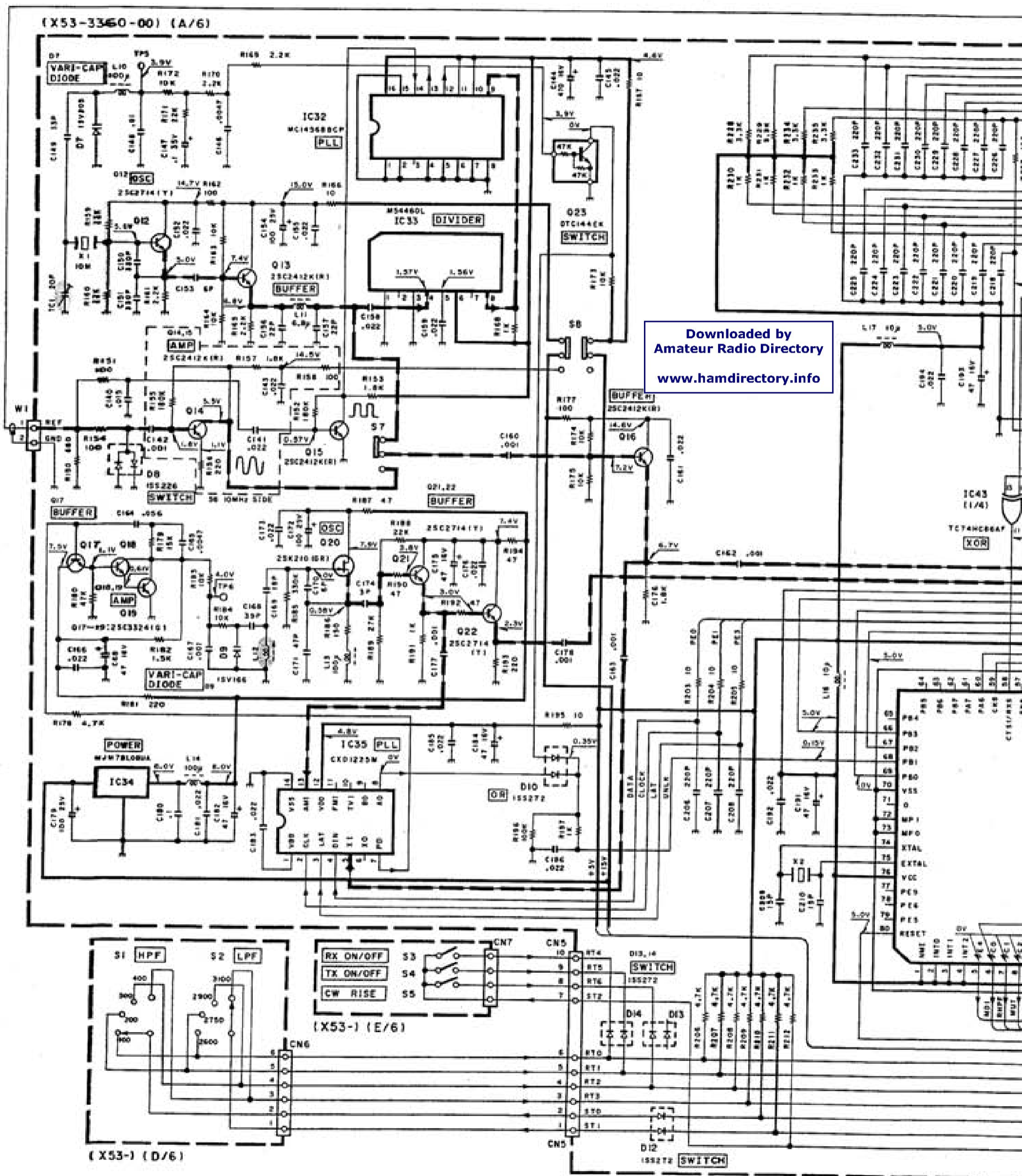



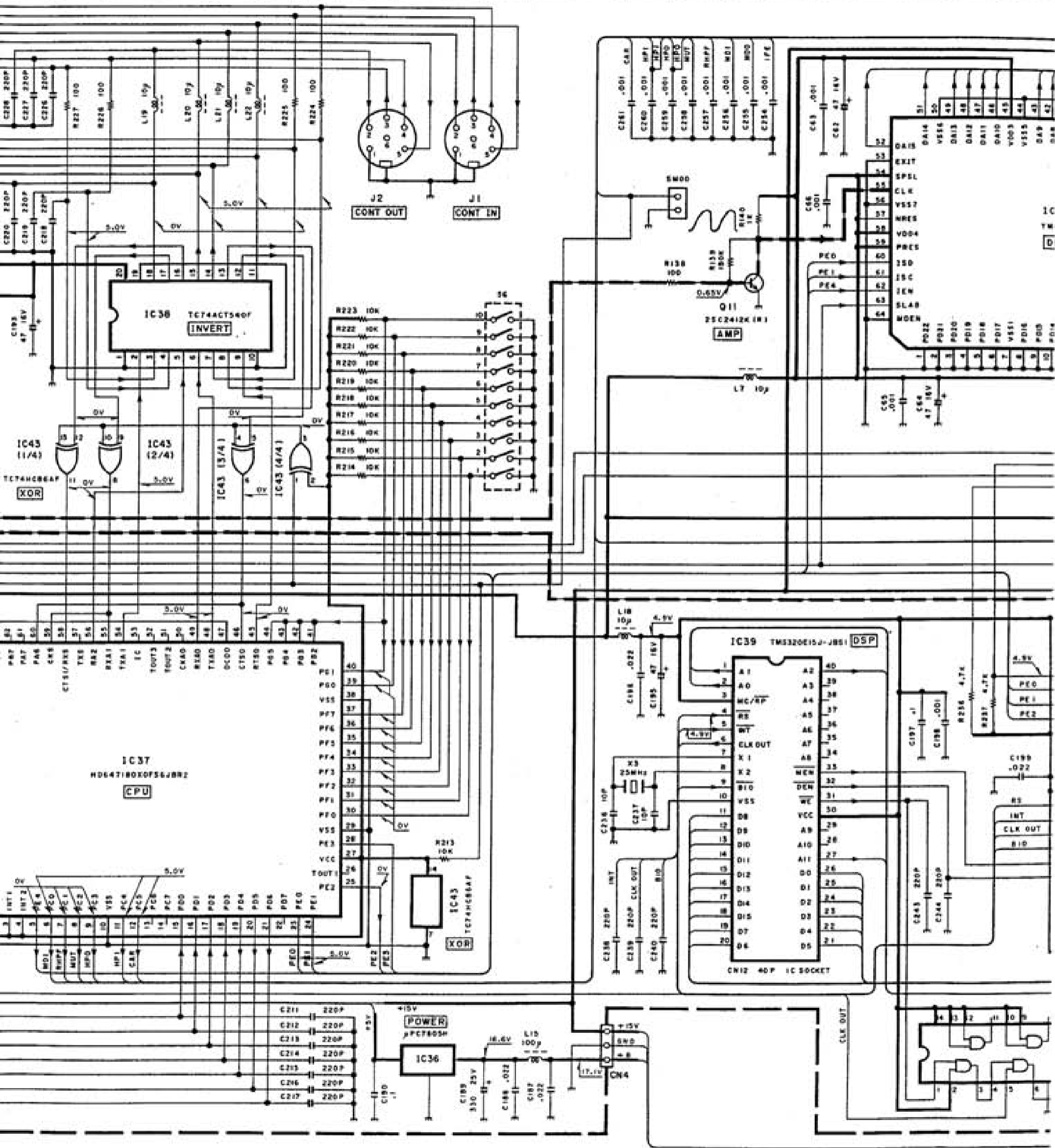

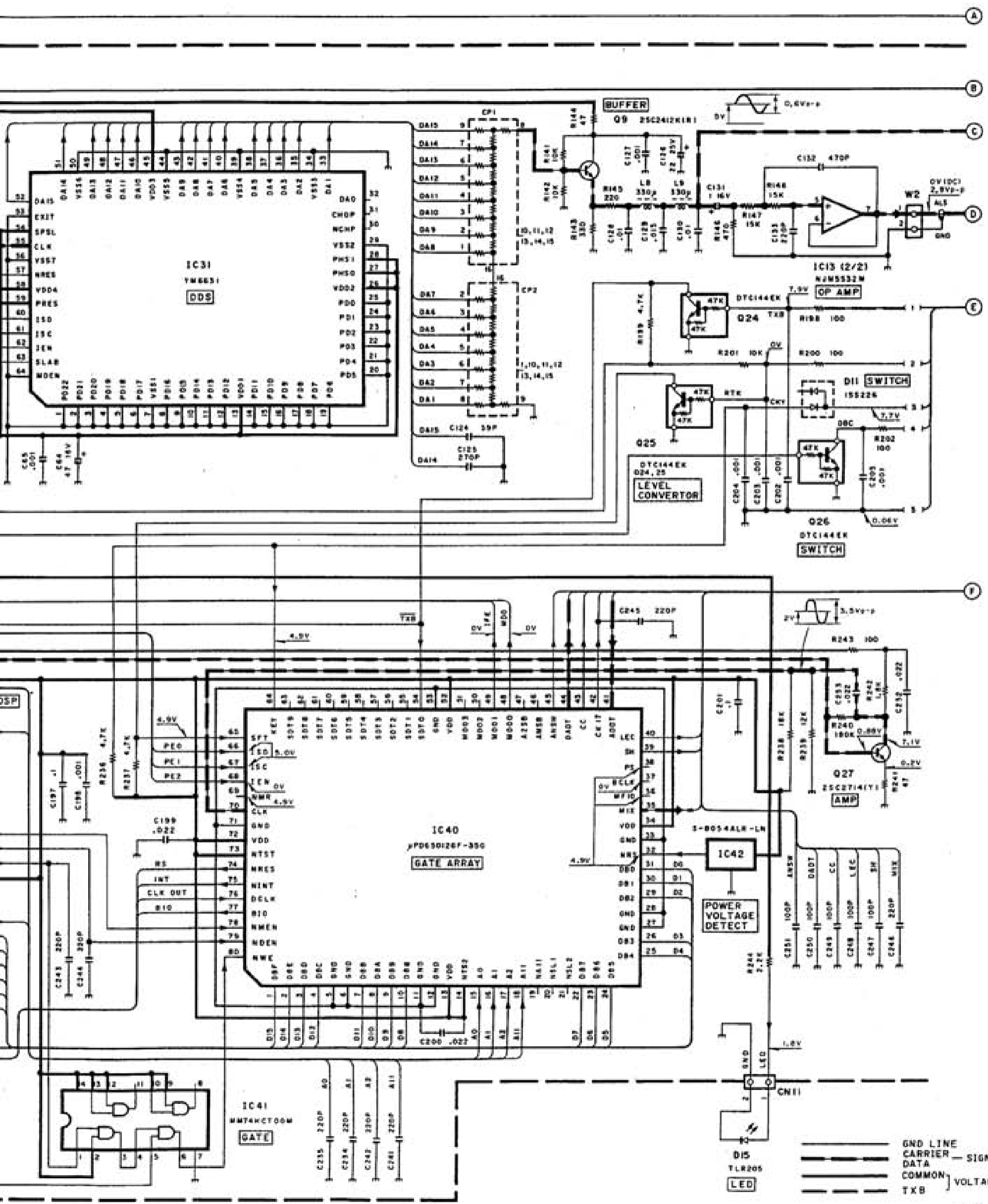

DSP-100 (J) (1/2)

GND LINE  
 CARRIER — SIGNAL LINE  
 DATA  
 COMMON  
 VOLTAGE LINE  
 TXB



(X53-3360-00) (A/6)

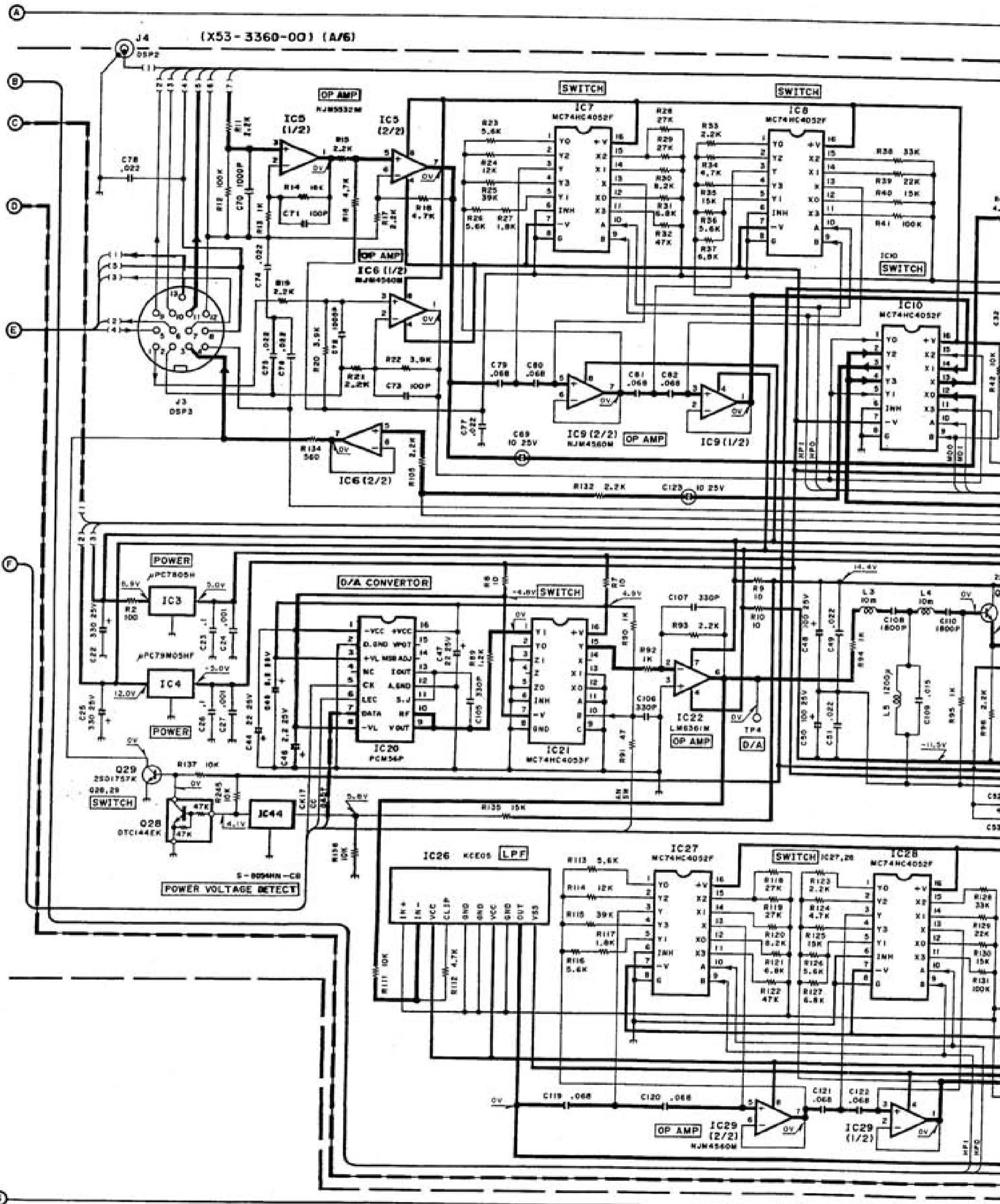

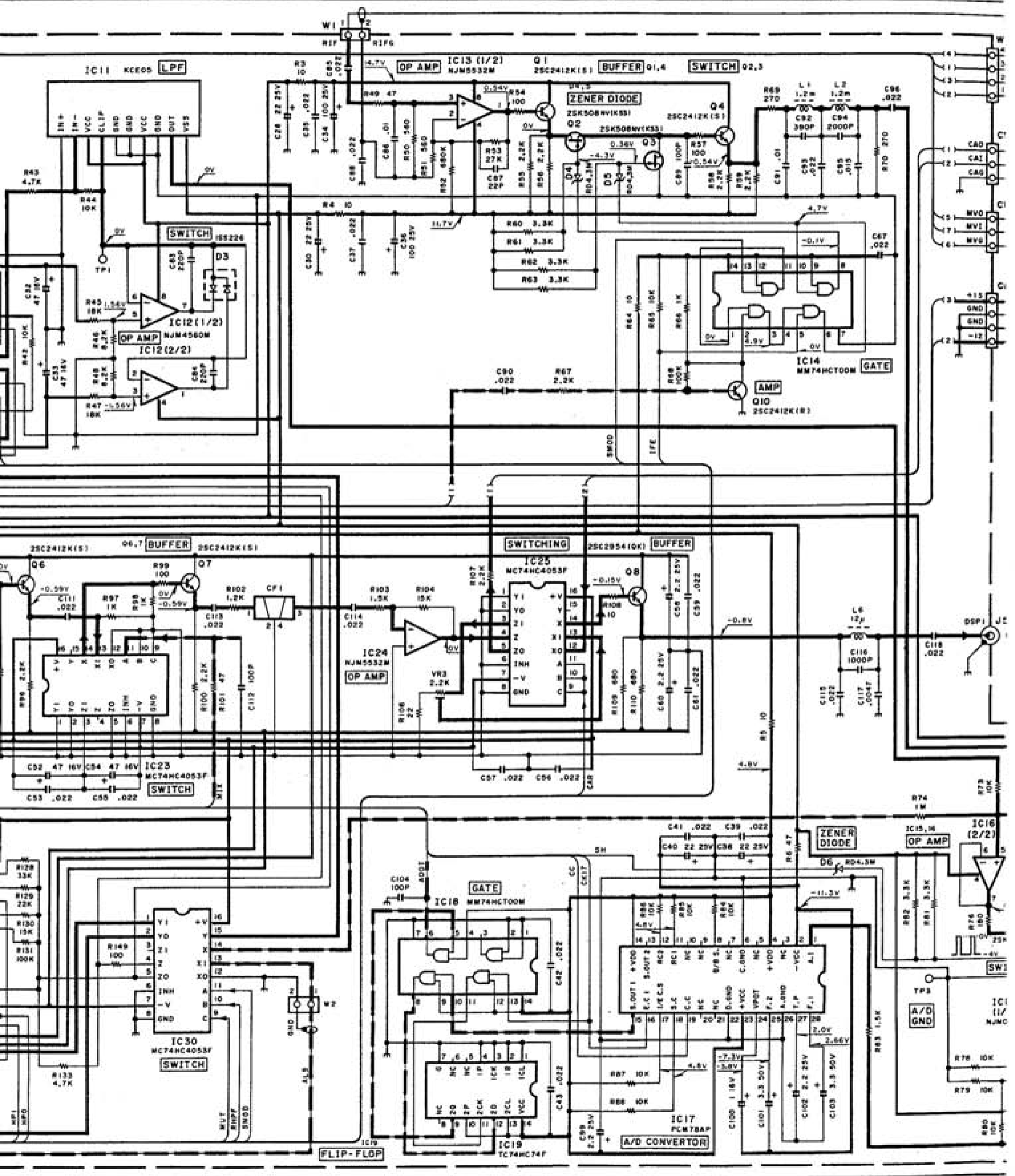

# SCHEMATIC DIAGRAM DSP-100

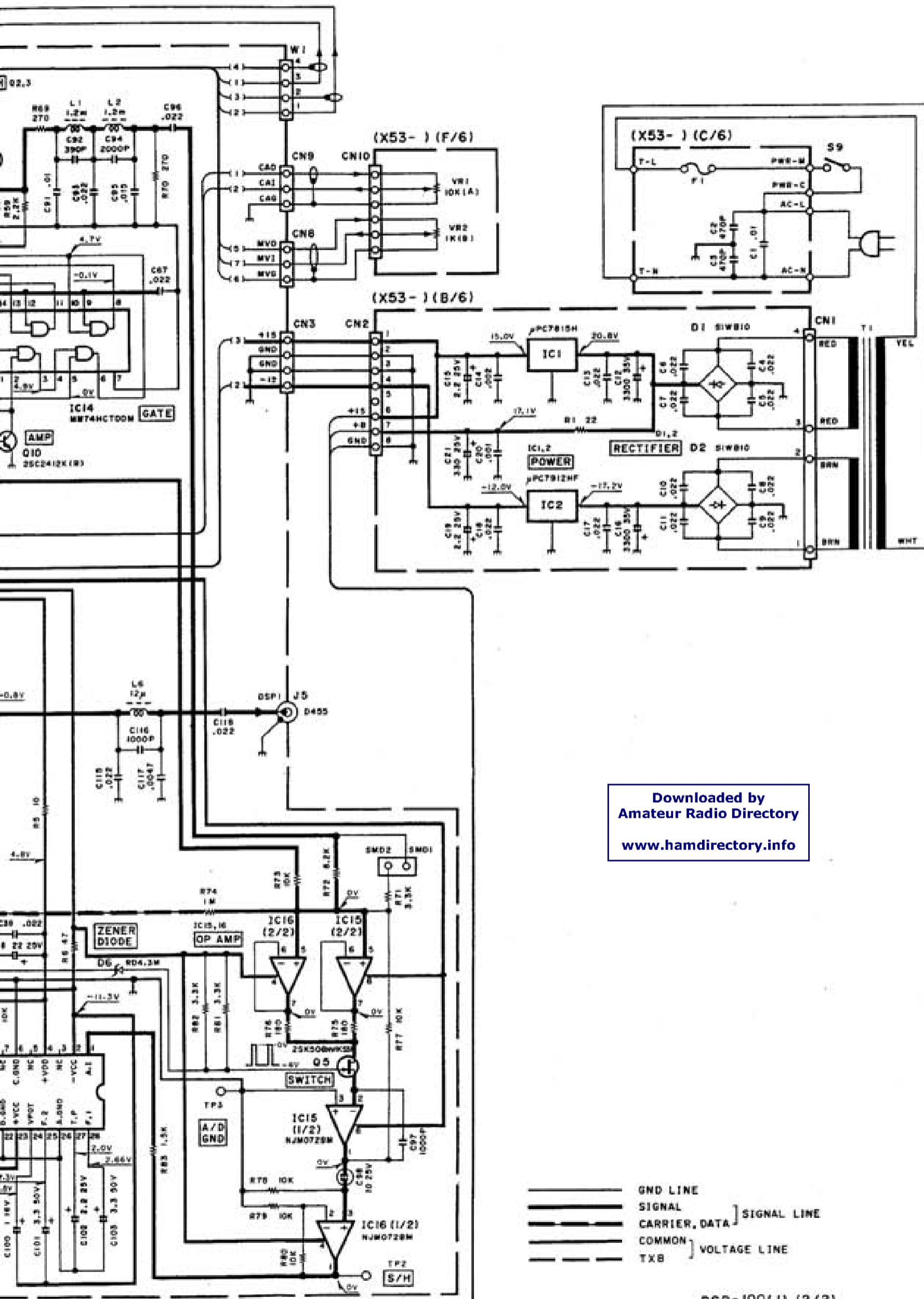

Downloaded by  
Amateur Radio Directory  
[www.hamdirectory.info](http://www.hamdirectory.info)

# DSP-100

## TERMINAL FUNCTION

Connector No.	Terminal No.	Terminal Name	Terminal Function
J1	1	GND	GND
	2	TXB	Transmit data
	3	RXD	Receive data
	4	CTS	Transmission enable
	5	RTS	Reception enable
	6	NC	
J2	1	GND	GND
	2	TXB	Transmit data
	3	RXD	Receive data
	4	CTS	Transmission enable
	5	RTS	Reception enable
	6	NC	
J3	1	DAF1	Audio input
	2	GND	GND
	3	DAF2	Audio output
	4	GND	GND
	5	DBC	DSP connect signal 0 : ON, 1 : OFF
	6	RTK	FSK keyer 0 : Mark, 1 : Space
	7	CKY	CW keying signal 0 : Key down, 1 : Key up
	8	GND	GND
	9	REF	10kHz or 10MHz reference signal
	10	GND	GND
	11	MAO	Microphone input
	12	MAG	MIC GND
	13	TXB	Transmission control 0 : Receive, 5~15 : Transmit
J4		DSP2	Receive IF
J5		DSP1	Transmit IF
CN1	1	J1	AC 16.5V
	2	J2	AC 16.5V
	3	J3	AC 20V
	4	J4	AC 20V
CN2	1	+15	+15V
	2	GND	GND
	3	GND	GND
	4	-12	-12V
	5	NC	
	6	+15	+15V
	7	+B	Unstable + power supply
	8	GND	GND

Connector No.	Terminal No.	Terminal Name	Terminal Function
CN3	1	+15	+15V
	2	GND	GND
	3	GND	GND
	4	-12	-12V
CN4	1	+15	+15V
	2		
	3	+B	Unstable + power supply
CN5	1	ST1	Key strobe
	2	ST0	Key strobe
	3	RT3	Key return
	4	RT2	Key return
	5	RT1	Key return
	6	RT0	Key return
	7	ST2	Key strobe
	8	RT6	Key return
	9	RT5	Key return
	10	RT4	Key return
CN6	1	ST1	Key strobe
	2	ST0	Key strobe
	3	RT3	Key return
	4	RT2	Key return
	5	RT1	Key return
	6	RT0	Key return
CN7	1	RT4	Key return
	2	RT5	Key return
	3	RT6	Key return
	4	ST2	Key strobe
CN8	1	MVO	Microphone volume output
	2	MVI	Microphone volume input
	3	MVG	Microphone volume ground
CN9	1	CAO	Carrier volume output
	2	CAI	Carrier volume input
	3	CAG	Carrier volume ground
CN10	1	MVG	Microphone volume ground
	2	MVI	Microphone volume input
	3	MVO	Microphone volume output
	4	CAG	Carrier volume ground
	5	CAI	Carrier volume input
	6	CAO	Carrier volume output
CN11	1	LED	For lighting LED
	2	GND	GND