

KENWOOD

R-5000

COMMUNICATIONS RECEIVER
INSTRUCTION MANUAL

MULTIBAND-EMPFÄNGER
BEDIENUNGSANLEITUNG

RECEPTOR DE COMUNICACIONES
MANUAL DE INSTRUCCIONES

RECEPTEUR
MANUEL D'INSTRUCTIONS

RICEVITORE PER TELECOMUNICAZIONI
ISTRUZIONI PER L'USO

KENWOOD CORPORATION

1. SAFETY

Before applying power

IMPORTANT!

U.S.A. and Canada

Units shipped to the U.S.A. and Canada are designed for operation on 120 volts AC only. These units are not equipped with an AC voltage selector switch and the discussion of such a switch that follows should be disregarded.

All other countries

Units shipped to countries other than the U.S.A., Canada are equipped with an AC voltage selector switch on the rear panel. Refer to the following paragraph for the proper setting of this switch.

AC voltage selection

This unit operates on 120 volts, 220 volts or 240 volts AC. The AC voltage selector switch on the rear panel is set to the voltage that prevails in the area to which the unit is shipped. Before connecting the power cord to your AC outlet, make sure that the setting position of this switch matches your line voltage. If not, it must be set to your voltage in accordance with the following direction.



Note:



Our warranty does not cover damage caused by excessive line voltage due to improper setting of the AC voltage selector switch.

WARNING:

TO PREVENT FIRE OR ELECTRIC SHOCK, DO NOT EXPOSE THIS APPLIANCE TO RAIN OR MOISTURE.

Safety precautions

<p>CAUTION RISK OF ELECTRIC SHOCK DO NOT OPEN</p>	<p>CAUTION: TO REDUCE THE RISK OF ELECTRIC SHOCK, DO NOT REMOVE COVER (OR BACK). NO USER-SERVICEABLE PARTS INSIDE. REFER SERVICING TO QUALIFIED SERVICE PERSONNEL.</p>
	<p>The lightning flash with arrowhead symbol, within an equilateral triangle, is intended to alert the user of the presence of uninsulated "dangerous voltage" within the product's enclosure; that may be of sufficient magnitude to constitute a risk of electric shock to persons.</p>
	<p>The exclamation point within an equilateral triangle is intended to alert the user of the presence of important operating and maintenance (servicing) instructions in the literature accompanying the appliance.</p>

120V	220V	240V
		
120V ~ Setting	220V ~ Setting	240V ~ Setting

Before plugging in this unit, make sure that the position of the AC voltage selector conforms to your line (mains) voltage. If not, it must be reset.

AC voltage selector switch

For United Kingdom

The mains plug must be removed from the wall socket prior to any internal examination.

Warning:

This apparatus must be earthed.

Important

The wires in this mains lead are coloured in accordance with the following code:

- Blue..... Neutral
- Brown..... Live
- Green-and-yellow..... Earth

The wires in this mains lead must be connected to the terminals in the plug as follows:

Wire colour	Plug terminal marking
Blue.....	N or Black
Brown.....	L or Red

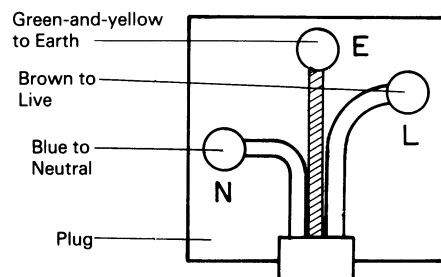

Notes:

- 1) If a 13-amp plug is used, this must be fitted with a 3-amp fuse.
- 2) If a 3-pin plug with earthing contact is used, no wire must be connected to the E terminal.

SAFETY INSTRUCTIONS

1. Read Instructions – All the safety and operating instructions should be read before the appliance is operated.
2. Retain Instructions – The safety and operating instructions should be retained for future reference.
3. Heed Warnings – All warnings on the appliance and in the operating instructions should be adhered to.
4. Follow Instructions – All operating and use instructions should be followed.
5. Water and Moisture – The appliance should not be used near water – for example, near a bathtub, wash-bowl, kitchen sink, laundry tub, in a wet basement, or near a swimming pool, and the like.
6. Wall or Ceiling Mounting – The appliance should be mounted to a wall or ceiling only as recommended by the manufacturer.
7. Ventilation – The appliance should be situated so that its location or position does not interfere with its proper ventilation. For example, the appliance should not be situated on a bed, sofa, rug, or similar surface that may block the ventilation openings; or, placed in a built-in installation, such as a bookcase or cabinet that may impede the flow of air through the ventilation openings.
8. Heat – The appliance should be situated away from heat sources such as radiators, heat registers, stoves, or other appliances (including amplifiers) that produce heat.
9. Power Sources – The appliance should be connected to a power supply only of the type described in the operating instructions or as marked on the appliance.
10. Grounding or Polarization – The precautions that should be taken so that the grounding or polarization means of an appliance is not defeated.
11. Power-Cord Protection – Power-supply cords should be routed so that they are not likely to be walked on or pinched by items placed upon or against them, paying particular attention to cords at plugs, convenience receptacles, and the point where they exit from the appliance.
12. Protective Attachment Plug – The optional DC operation kit is supplied with an attachment plug having overload protection. This is a safety feature. See Instruction Manual for replacement or resetting of protective device. If replacement of the plug is required, be sure the service technician has used a replacement plug specified by the manufacturer that has the same overload protection as the original plug.
13. Cleaning – The appliance should be cleaned only as recommended by the manufacturer.
14. Power Lines – An outdoor antenna should be located away from power lines.
15. Outdoor Antenna Grounding – If an outside antenna is connected to the receiver, be sure the antenna system is grounded so as to provide some protection against voltage surges and built up static charges. Section 810 of the National Electrical Code, ANSI/NFPA No. 70 – 1984, provides information with respect to proper grounding of the mast and supporting structure, grounding of the lead-in wire to an antenna discharge unit, size of grounding conductors, location of antenna-discharge unit, connection to grounding electrodes, and requirements for the grounding electrode. See accompanying Figure.
16. Nonuse Periods – The power cord of the appliance should be unplugged from the outlet when left unused for a long period of time.
17. Object and Liquid Entry – Care should be taken so that objects do not fall and liquids are not spilled into the enclosure through opening.
18. Damage Requiring Service – The appliance should be serviced by qualified service personnel when:
 - A. The power-supply cord or the plug has been damaged; or
 - B. Objects have fallen, or liquid has been spilled into the appliance; or
 - C. The appliance has been exposed to rain; or
 - D. The appliance does not appear to operate normally or exhibits a marked change in performance; or
 - E. The appliance has been dropped, or the enclosure damaged.
19. Servicing – The user should not attempt to service the appliance beyond that described in the operating instructions. All other servicing should be referred to qualified service personnel.

**EXAMPLE OF ANTENNA GROUNDING ACCORDING
TO NATIONAL ELECTRICAL CODE INSTRUCTIONS
CONTAINED IN ARTICLE 810 – "RADIO AND
TELEVISION EQUIPMENT"**

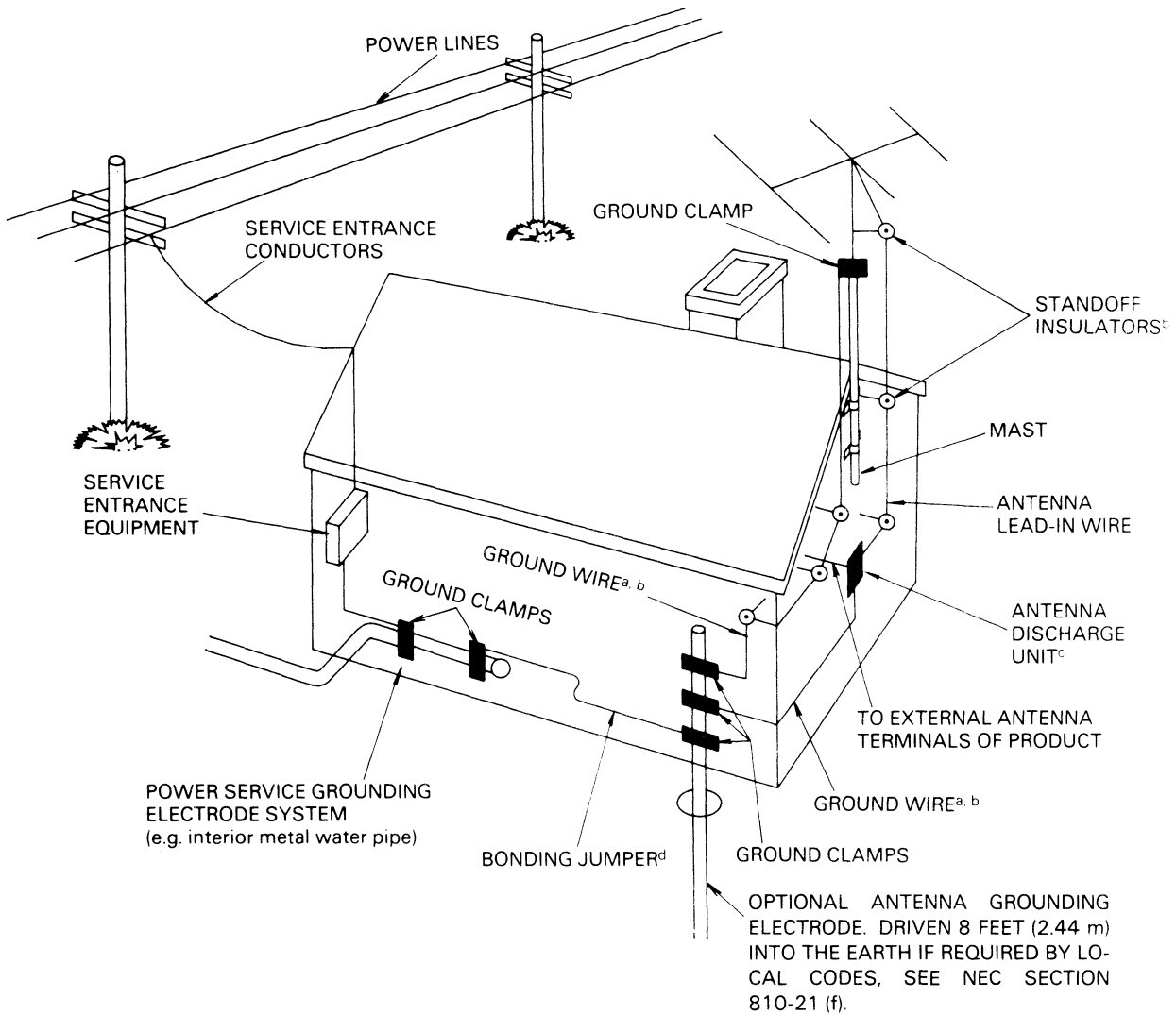

^a Use No. 10 AWG (5.3 mm²) copper, No. 8 AWG (8.4 mm²) aluminum, No. 17 AWG (1.0 mm²) copper-clad steel or bronze wire, or larger, as a ground wire.

^b Secure antenna lead-in and ground wires to house with standoff insulators spaced from 4 – 6 feet (1.22 – 1.83 m) apart.

^c Mount antenna discharge unit as close as possible to where lead-in enters house.

^d Use jumper wire not smaller than No. 6 AWG (13.3 mm²) copper, or the equivalent, when a separate antenna-grounding electrode is used. See NEC section 810-21(j).

Before operation

Safety precautions

Never remove the case. If the internal parts are touched accidentally, a serious electric shock might occur.

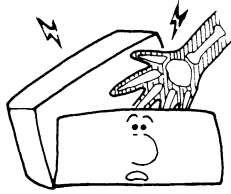

If a metal object, such as a hair pin or a needle, comes into contact with the power socket on the rear panel, a dangerous electric shock may result. For families with children, never permit children to put anything, especially metal, inside this unit.



Touching the power plug when your hands are wet may result in a serious electric shock.

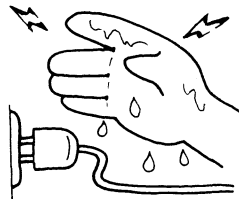

Never pull, bend or extend the power cord. This could damage the power cord, resulting in a broken cord or short-circuit.

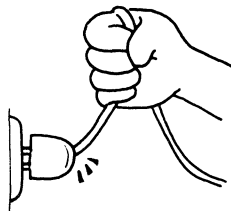

Where to install the unit

Do not place the unit near a heat producing equipment such as a radiator. Avoid direct sunlight.

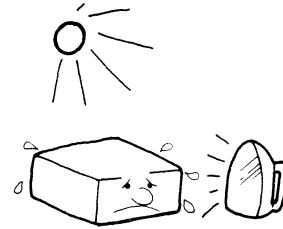

Do not store or use the unit in a dusty location or in a moist atmosphere. Select a location where air is well ventilated.

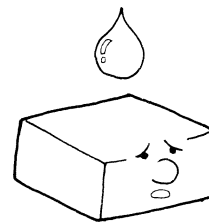

Install the unit approx. 10 cm (or 4 inches) away from the wall, for heat dissipation.

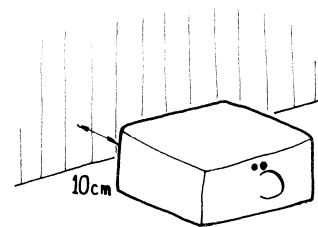

Install the unit on a flat, vibration-free rigid table.



The unit may not function properly if used at extremely low, or freezing temperatures. The ideal ambient temperature is above +5°C (41°F).



Thank you for purchasing the new R-5000 Communications Receiver. Please read this Instruction Manual carefully before placing your receiver in service. This unit has been carefully engineered and manufactured to rigid quality standards, should give you satisfactory and dependable operation for many years.

CONTENTS

1. SAFETY	2	5. MAINTENANCE	27
2. SPECIFICATIONS AND ACCESSORIES	7	5-1. GENERAL INFORMATION.....	27
2-1. SPECIFICATIONS.....	7	5-2. SERVICE.....	27
2-2. ACCESSORIES.....	8	5-3. CLEANING.....	27
3. INSTALLATION AND CONNECTION	9	5-4. IN CASE OF DIFFICULTY.....	28
3-1. INSTALLATION.....	9	6. OPTIONAL ACCESSORIES	29
3-2. CONNECTION.....	9	7. REFERENCES	30
4. OPERATION	12	7-1. ENJOYING SW RECEPTION	30
4-1. CONTROL FUNCTIONS.....	12	7-2. ANTENNA AND GROUNDING	32
4-2. RECEIVE	18	8. BLOCK DIAGRAM AND CIRCUIT DIAGRAM	34
4-3. MEMORY.....	21	8-1. BLOCK DIAGRAM	34
4-4. SCAN	23	8-2. CIRCUIT DIAGRAM	35
4-5. CLOCK AND TIMER	25		

Caution: _____

Optional accessory installation – The user should not attempt to install the optional accessory beyond that described in the operating instructions. All installations should be referred to qualified service personnel.

Note: _____

Illustrations show the R-5000 U.S.A. version unless specified in this Instruction Manual.

2. SPECIFICATIONS AND ACCESSORIES

2-1. SPECIFICATIONS

Specifications		Model					
		U.S.A. version	Europe, U.K. and other market versions	Australia version	West Germany version		
Circuitry	AM/USB/LSB/CW/FSK	Double conversion superheterodyne					
	FM	Triple conversion superheterodyne					
Antenna impedance	ANT 1	50 ohms					
	ANT 2	50/500 ohms					
Frequency range *1		100 kHz to 30 MHz 108 to 174 MHz	2 to 30 MHz 108 to 174 MHz	150 kHz to 26.2 MHz 144 to 146 MHz			
Intermediate frequency	AM/USB/LSB/CW/FSK	1st: 58.1125 MHz, 2nd: 8.83 MHz					
	FM	1st: 58.1125 MHz, 2nd: 8.83 MHz, 3rd: 455 kHz					
Mode		AM(A3E)/USB(J3E)/LSB(J3E)/CW(A1A)/FM(F3E)/FSK(F1B)					
Sensitivity							
Frequency range		100 to 150 kHz	150 to 500 kHz	500 kHz to 1.8 MHz	1.8 to 30 MHz	108 to 123 MHz *1	123 to 174 MHz *1
Mode							
USB/LSB/CW/FSK (at 10 dB S + N/N)		Less than 2.5 μ V	Less than 1 μ V	Less than 4 μ V	Less than 0.25 μ V	Less than 0.5 μ V	Less than 0.25 μ V
AM (at 1 kHz 30% mod.)		Less than 25 μ V	Less than 10 μ V	Less than 32 μ V	Less than 2 μ V	Less than 4 μ V	Less than 2 μ V
FM (at 12 dB SINAD)		—	—	—	Less than 0.5 μ V	Less than 1 μ V	Less than 0.5 μ V
Selectivity							
				USB/LSB/CW/FSK	-6 dB	2.4 kHz	
					-60 dB	4.4 kHz	
				AM	-6 dB	6 kHz	
					-50 dB	20 kHz	
				FM	-6 dB	12 kHz	
					-50 dB	25 kHz	
Image ratio							
		100 kHz to 1.8 MHz	1.8 to 30 MHz	108 to 123 MHz *1	123 to 174 MHz *1		
		More than 60 dB	More than 80 dB	More than 40 dB	More than 50 dB		
1st IF rejection							
		100 kHz to 1.8 MHz	1.8 to 30 MHz	108 to 123 MHz *1	123 to 174 MHz *1		
		More than 60 dB	More than 80 dB	More than 70 dB	More than 80 dB		
IF SHIFT variable range		More than \pm 0.9 kHz					
NOTCH filter attenuation		More than 25 dB (500 to 2600 Hz)					
Squelch sensitivity							
Frequency range		100 to 150 kHz	150 to 500 kHz	500 kHz to 1.8 MHz	1.8 to 30 MHz	108 to 123 MHz *1	123 to 174 MHz *1
Mode							
AM/USB/LSB/CW/FSK		Less than 20 μ V	Less than 10 μ V	Less than 20 μ V	Less than 2 μ V	Less than 10 μ V	Less than 2 μ V
FM		—	—	—	Less than 0.32 μ V	Less than 1 μ V	Less than 0.32 μ V

Frequency accuracy		Less than ± 10 PPM	
Frequency stability		Less than ± 10 PPM	
Output	EXT. speaker	1.5 W across 8 ohms load (10% distortion)	
	REC jack	300 mV across 4.7 k Ω load (at 1 mV input with 30% mod. in AM or 3 kHz dev. in FM)	
Output load impedance		8 ohms min.	
Clock	Type	Quartz clock	
	Accuracy	Less than ± 60 seconds/month	
Power requirement *2		120 VAC $\pm 10\%$, 60 Hz or 13.8 VDC $\pm 15\%$	120/220/240 VAC $\pm 10\%$, 50/60 Hz or 13.8 VDC $\pm 15\%$
Power consumption		40 watts (AC) or 2 A (DC)	
Operating temperature		-10 to +50°C (+14 to +122°F)	
Dimensions. W x H x D () includes projection.		270 x 96 x 270 mm (279 x 107 x 307 mm)	
Weight		5.6 kg (12.3 lbs)	

Notes:

1. *1: The optional VC-20 VHF Converter Unit is required for the VHF reception.
2. *2: The optional DCK-2 DC Operation Kit is required for the DC Operation.
3. Circuit and ratings are subject to change without notice due to advancements in technology.

2-2. ACCESSORIES

Unpack your R-5000 carefully and confirm that it is supplied with the following accessories.

AC power cable (U.S.A. and Canada only)	(E30-2071-05)	1 ea.
AC power cable (Europe only)	(E30-1645-05)	1 ea.
AC power cable (Oceania only).....	(E30-1647-05).....	1 ea.
AC power cable (U.K. only).....	(E30-1644-15).....	1 ea.
AC power cable (Other markets only).....	(E30-1305-15).....	1 ea.
Instruction manual.....	(B50-8237-XX)	1 copy
Warranty card.....		1 ea.

Shipping container:

Save the boxes and packing in the event your unit needs to be transported for remote operation, maintenance, or service.

3. INSTALLATION AND CONNECTION

3-1. INSTALLATION

3-1-1. Bail

The receiver can be elevated for operating convenience.

Caution:
Do not use the bail to carry the receiver.

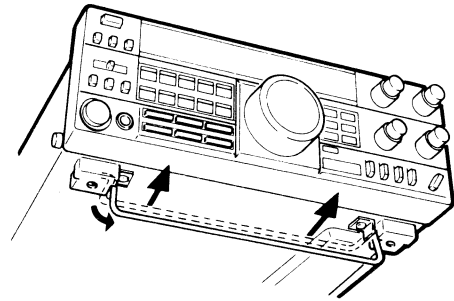

3-2. CONNECTION

3-2-1. Rear panel

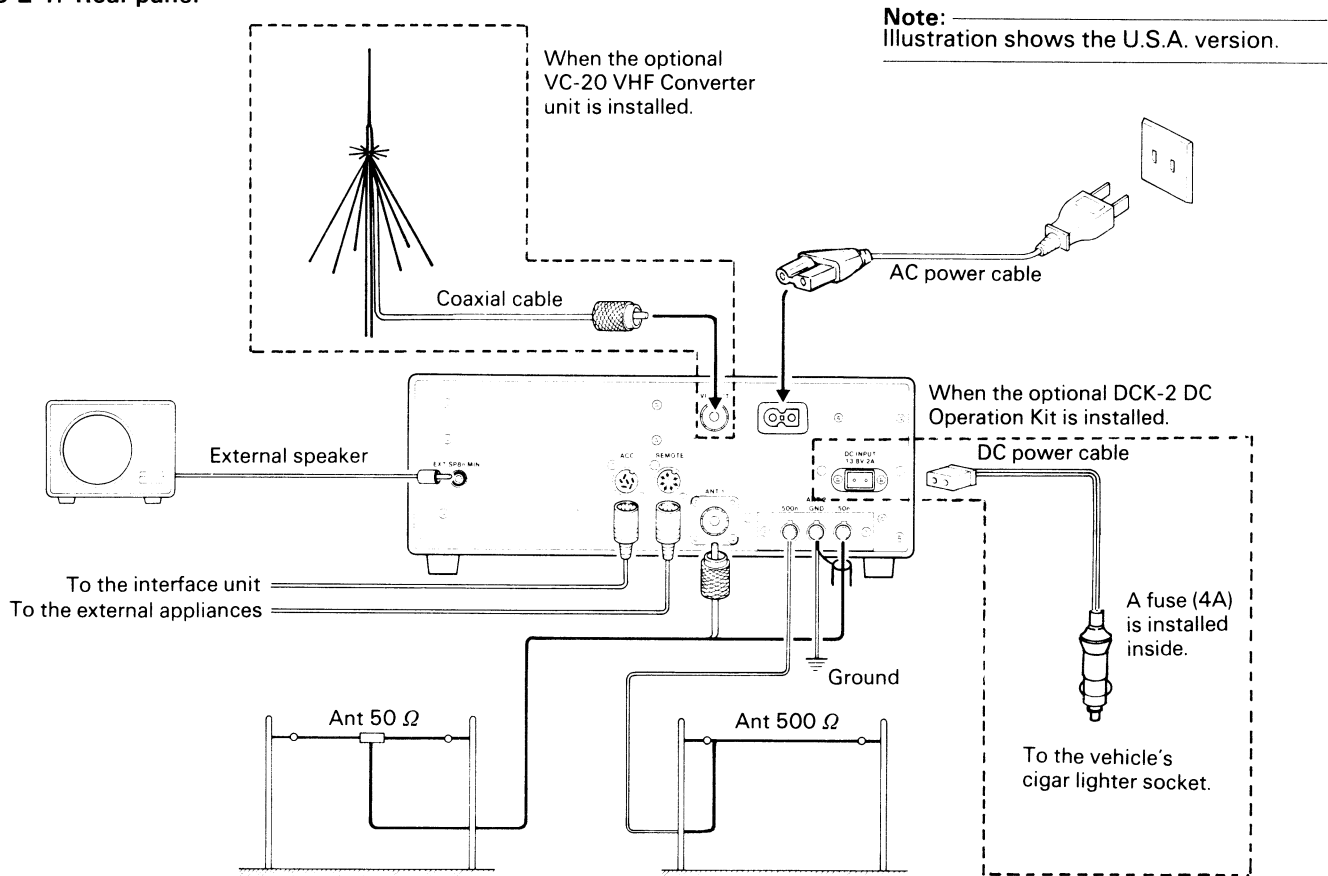

Note:
Illustration shows the U.S.A. version.

A. Power supply

- Cautions:**
1. The POWER switch must be OFF before you connect or disconnect the power cable.
 2. Do not apply AC and DC power sources at the same time.

(A) AC operation

When the R-5000 is to be operated from a fixed location using normal household current you should connect the AC power cable that is supplied with the radio to the AC terminal on the rear panel.

(B) DC operation (The optional DCK-2 DC Operation Kit is required for this operation.)

The R-5000 can also be operated from a 12 volt automobile battery. Attach the power cable that is supplied with the DCK-2 DC Operation Kit to the cigarette lighter socket in your vehicle.

Cautions:

1. The DCK-2 DC Operation Kit, should be installed by qualified service personnel to prevent personal injury or damage to the equipment.
2. When charging the battery or when jump starting a dead battery you MUST disconnect the power cable from the back of the radio, or serious damage may result to the radio.
3. The clock and the timer function even if the POWER switch is turned OFF. When the receiver is not in use, unplug the cigarette lighter plug from the vehicle's cigarette lighter socket to prevent the battery from discharging.

B. Antenna and grounding

(A) Antenna

Installation of antenna and grounding is important for optimum reception of short-wave, broadcast or amateur radio signals. A good outdoor antenna will provide the best results.

Caution: _____
Protect your Equipment — Use a LIGHTNING ARRESTOR.

Note: _____
A simple method is to install the wire antenna as high as possible, it must be extended to its full length for good results.

ANT 1: UHF coaxial antenna connector
Use a low impedance antenna. The antenna feeder should be a coaxial cable equipped with a PL-259 connector.

ANT 2: 500-ohm antenna terminal
Connect a high impedance antenna such as a long wire antenna.
50-ohm antenna terminal
Connect a low impedance antenna.

Note: _____
To connect both 500-ohm and 50-ohm antenna terminals at the same time may cause the receiving sensitivity worse.

C. External speaker

The R-5000 includes a built-in speaker. If you would like to use an external speaker, such as the SP-430, it may be connected to the EXT SP jack on the rear of the radio. The speaker may be any good 8 ohm permanent magnet type speaker. The diameter should be at least 4 inches for

VHF ANT connector (Optional VC-20 VHF Converter is required for VHF reception.)

When an outdoor antenna is used the antenna feeder should be a coaxial cable equipped with a UHF connector.

Caution: _____
The VC-20 VHF Converter Unit should be installed by qualified service personnel to prevent personal injury or damage to the equipment.

(B) Grounding

Making a good earth connection is important for preventing dangers such as electric shock. Bury a commercially available ground rod or copper plate under the ground and connect it to the GND terminal. A thick wire, cut as short as possible, should be used for the connection. To make a good earth connection, connect the GND terminal to a grounded metal water pipe.

Caution: _____
Never use a gas pipe or electrical conduit pipe.

Note: _____
A city water pipe cannot be used as a good earth in some cases.

good audio quality. If you plan on using a speaker other than the SP-430 it should be equipped with a miniature phone jack plug.

The internal speaker is disabled when the external speaker plug is inserted into the receptacle.

3-2-2. Front panel

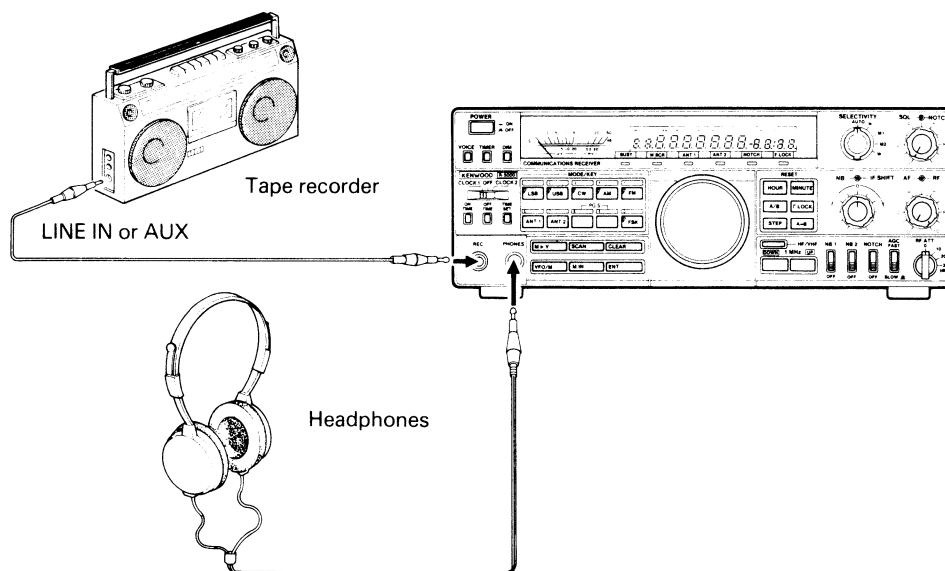

A. Headphones

Any low-impedance (4 ~ 16 ohms) headphones may be used with the R-5000. Connect the headphones to the front-panel phone jack.

The optional HS-5 or HS-6 headphones are best suited for use with the R-5000. Stereo type headphones can also be used.

B. Tape recorder

This terminal may be used for recording broadcasts on tape. Connect it to the LINE IN jack of your tape recorder. The output level at this terminal is constant, regardless on the AF gain control setting.

3-2-3. Connecting the R-5000 with a transmitter or transceiver

1. Ground the REMOTE connector pin (pin 7) to mute the R-5000 audio during transmission.

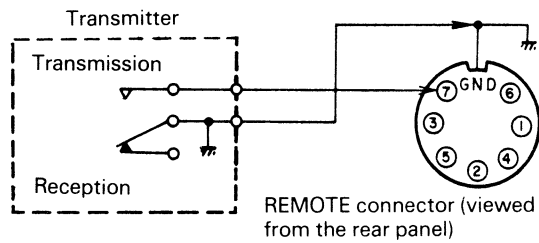

Transmitter relay-muted circuit

Viewed from the cord side.

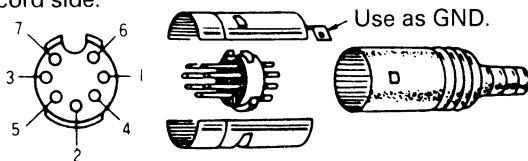

REMOTE connector

The open-circuit voltage at pin 7 is about +4.8 VDC; the short circuit current is about 0.4 mA DC.

2. Connect the antenna to the R-5000 via the transmitter or transceiver antenna switching relay. If you are using a receive-only antenna, disconnect it from the R-5000 while transmitting.

Cautions:

1. Failure to disconnect the antenna from the R-5000 when transmitting on a separate transmitter/transceiver will result in damage to the R-5000.
2. Do not apply AC voltage to the REMOTE connector.

4. OPERATION

4-1. CONTROL FUNCTIONS

4-1-1. Front panel

Scanned by Vincent
Downloaded by
RadioAmateur.EU

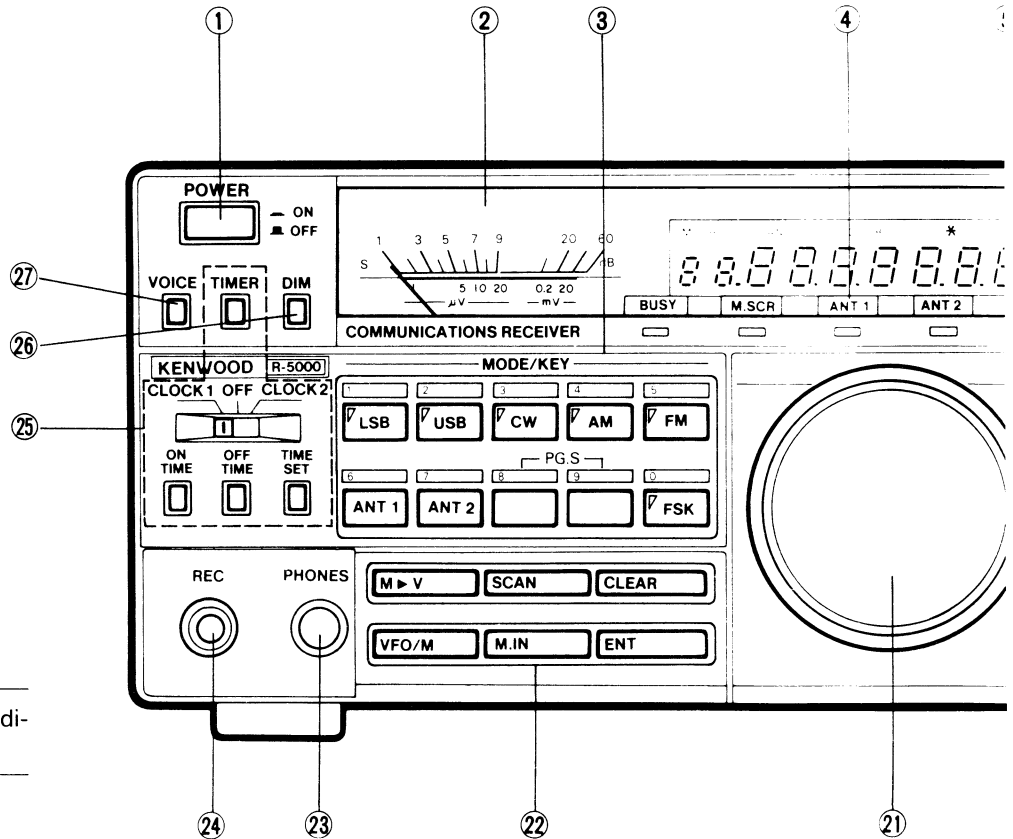

Note: _____
All segments on the Display Panel and Indicators are shown on for this explanation.

① POWER switch

Press to turn the power ON or OFF.

Note: _____
When the AC or DC power cable is connected the clock and the timer function even if the POWER switch is turned OFF.

② Meter

Indicates signal strength in S units and antenna terminal input voltage.

③ MODE/KEY (Numeric Keypad)

These keys are used to select the desired mode of operation and the antenna.

- LSB : Lower Sideband
- USB : Upper Sideband
- CW : Continuous Wave
- AM : Amplitude Modulation
- FM : Frequency Modulation
- FSK : Frequency Shift Keying
- ANT 1: Antenna 1
- ANT 2: Antenna 2

When programming a memory channel or directly entering a frequency these keys are used as a numeric keypad to enter the channel number or frequency. FM mode is suitable for the narrow band FM (maximum frequency deviation: $\pm 5\text{kHz}$) reception.

④ Indicators

- F.LOCK** : Lights when the F.LOCK key is ON.
- NOTCH** : Lights when the NOTCH key is ON.
- ANT 2** : Lights when the ANT 2 key is pressed.
- ANT 1** : Lights when the ANT 1 key is pressed.
- M.SCR** : Lights when the M.IN key is pressed. When the memory scroll function is active you can review the contents of the memory channels without a loss of the incoming receive frequency.
- BUSY** : Lights when the squelch opens. (A signal is received that is strong enough to produce a good quality audio output.)

⑤ Display Panel

The fluorescent display tube displays operational information such as receive frequency, and memory channel information. (See page 15.)

⑥ FUNCTION keys

- HOUR** : See page 25.
- MINUTE** : See page 25.
- A/B** : Selects VFO A or VFO B. (See page 19.)
- F.LOCK** : The selected dial frequency and mode are locked.
- STEP** : Selects the VFO frequency step. (See page 19.)
- A = B** : Equalizes the frequencies and modes of VFO A and VFO B. (See page 19.)

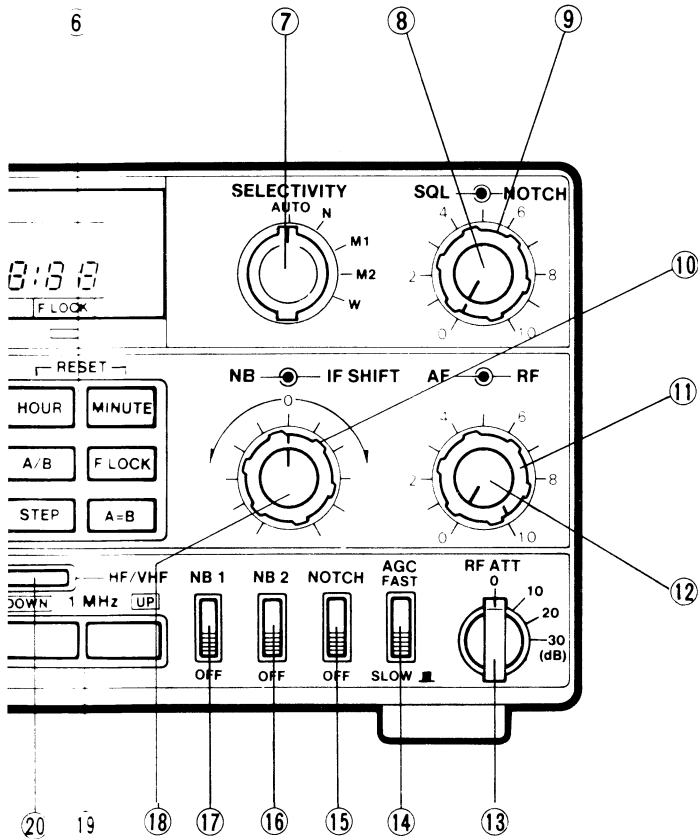

⑦ SELECTIVITY switch

When an optional filter is installed, the receiver's passband can be switched to one of four different bandwidths by using the SELECTIVITY switch.

The switch has five positions; AUTO, N, M1, M2 and W, that are used to select the bandwidth. This switch should normally be set to the AUTO position. The IF bandwidth will then be selected for optimum receiver characteristics, according to the MODE that has been selected. Manual override is possible by simple rotation of the SELECTIVITY switch.

The table on page 16 shows the bandwidth of each switch setting. Note the differences when the optional filters are installed.

Caution: _____
Optional filter should be installed by qualified service personnel to prevent personal injury or damage to the equipment.

Note: _____
When in the FM mode the bandwidth is always 12kHz, regardless of the position of the SELECTIVITY switch.

⑧ SQL (Squelch) control

This control is used to eliminate atmospheric noise, and receiver static noise during no signal periods. Slowly rotate the control clockwise to the point where the ambient noise just disappears, and speaker shuts off. This point is

known as the squelch threshold point. Now you will only hear output from the speaker when an incoming signal is present. For weak signal reception this control should be fully counterclockwise.

Note: _____
The squelch threshold position will vary from mode to mode, so you may have to readjust when you change mode.

⑨ NOTCH control

The NOTCH function is used to reduce or eliminate heterodyne, or CW type signal interference.

If a single tone such as a CW signal is superimposed on the receive signal, turn the NOTCH switch ON and slowly adjust the NOTCH control to eliminate or minimize the beat signal. Normally the NOTCH point will occur between 11:00 and 1:00.

The NOTCH filter will not be effective against SSB, AM or FM type signals, only single tone CW type signals.

In the CW mode, an audio peak filter (APF) is automatically selected; adjust the NOTCH control for the best signal.

In CW, we recommend the use of a CW filter (YK-88C or YK-88CN). When a CW filter is installed, the APF is disconnected.

Without a CW filter installed, APF is connected in CW mode. The APF works in similar fashion as a CW filter.

Note: _____
The NOTCH function is used to reduce or eliminate heterodyne, or CW type signals.

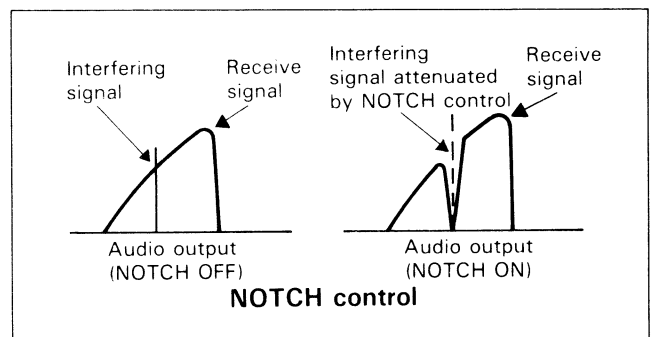

⑩ IF SHIFT control

The IF SHIFT control allows you to shift the IF passband of the receiver, without changing the actual center frequency of the receiver. This control is useful when there is interference near your center frequency.

Interference from lower frequencies can be reduced or eliminated by rotating the IF SHIFT control clockwise. This will cause the resulting audio frequencies to have a slightly treble response, i.e. low cut filter (low frequencies attenuated). Interference from higher frequencies can be reduced or eliminated by rotating the IF SHIFT control counterclockwise. This will cause the resulting audio frequencies to sound a little bassy, i.e. high cut filter (high frequencies attenuated).

Note: _____
The IF SHIFT control does not function in the AM or FM modes.

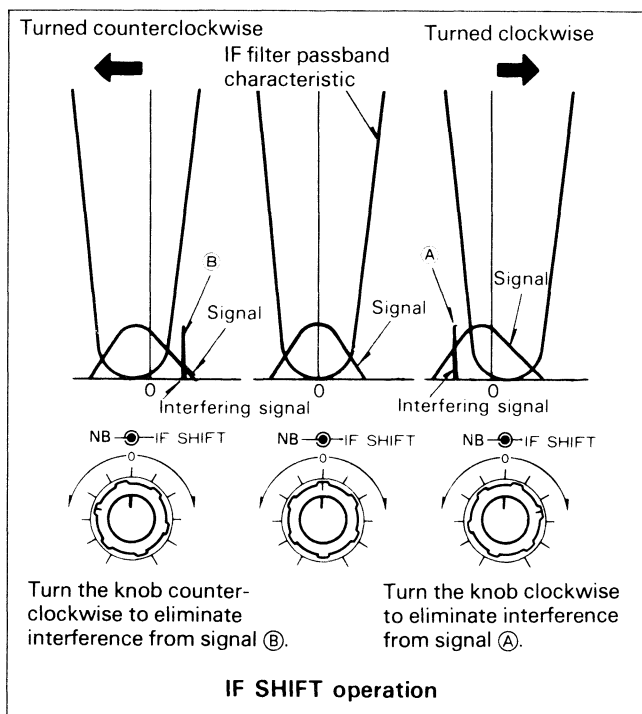

11 RF gain control

This control adjusts the gain of the receiver high-frequency amplifier section.

For normal receiver performance, and maximum gain, this control should be in the full clockwise position. If you are having trouble copying the desired signal make a note of the stations peak S-meter reading. Then, adjust the RF control counterclockwise, so that the meter needle is stationary at this level. Now, all signals that were less than the desired signal will be attenuated, such as static noise, etc., making reception easier.

If the incoming signal pegs the S-meter you can also reduce the receiver gain by counterclockwise rotation of the RF control. The S-meter pointer will always advance upscale as the RF control is rotated counterclockwise, as a visual reminder that the gain of the radio has been reduced.

Simultaneous use of the RF gain control and AGC switch

If a strong signal (such as a local station) appears in the vicinity of the intended receive signal, the S-meter may show unusual deflection due to the AGC voltage developed from the strong disturbing signal. If this occurs, turn the RF gain control counterclockwise so the meter pointer remains at about the original deflection peak and turn the AGC switch to the FAST position. This will reduce the unwanted AGC voltage and permit clear reception.

12 AF gain control

Turn the knob to increase or decrease the volume. Clockwise rotation increases the volume and counterclockwise rotation decreases the volume.

13 RF ATT (Attenuator) switch

When the incoming receive signal is very strong, the signal should be attenuated to prevent distortion of the sig-

nal, thereby stabilizing the receiver performance. This is easily done by activating the RF ATT switch. This control is also useful when a strong signal is near your desired signal; while some loss will occur to the desired signal, as well as the undesired signal, the use of the attenuator will sometimes allow you to understand what is being received. This switch allows attenuation of the input signal by 10, 20 or 30 dB. For normal receiver performance, this switch should be in the 0 dB position.

Note:

When using the VC-20 VHF converter you might occasionally encounter carrier interference from Television or FM broadcast stations. If you encounter any unknown interference rotate the RF ATT switch to the 10 dB position. This will help to reduce any cross modulation that might occur due to the strength of these types of signals.

14 AGC switch

This switch selects the operating time constant of the AGC (Automatic Gain Control) circuit. When the AGC switch is set to SLOW, the receiver gain and S-meter readings will react slowly to large input changes, and when set to FAST, the receiver gain and S-meter will react quickly to changes in the input signal level.

The normal position when using all modes is the SLOW position. When working any of the following you might wish to use the FAST position.

- When tuning with the TUNING dial.
- When receiving weak signals.
- When a high-speed CW signal is being received.

Note:

This switch is disabled during FM operations.

15 NOTCH switch

When the NOTCH switch is turned ON, the NOTCH control functions as a NOTCH filter (except in the CW mode). In the CW mode, the NOTCH control functions as an APF (Audio Peak Filter).

16 NB 2 switch

Noise blanker 2 is used for long duration pulse noise, like the "woodpecker". To reduce "woodpecker" radar noise interference, set switch NB 2 to the ON position (NB 2's effectiveness depends on the specific type of interference). If you use NB 2 for short duration pulse noise, the receive tone may become distorted, making it difficult to hear.

Unfortunately no noise blanker can remove all different types of interference, but the two noise blankers that have been provided in the R-5000 are effective in most cases. If there is no "woodpecker" present, the switch should be in the OFF position.

Note:

NB2 is disabled during FM operations.

17 NB 1 switch

For pulse type noise, such as generated by automotive ignition systems, turn the NB 1 switch ON.

When pulsating noise, such as that caused by automobile ignitions is encountered, place the NB 1 switch ON. This switch will not help to eliminate atmospheric or line noises, only pulse type noise.

Note: _____
NB 1 is disabled during FM operations.

18 NB level control

Controls the noise blanker operating level.
Use only the minimum level necessary.

19 1 MHz (UP/DOWN) key

Increases (UP) or decreases (DOWN) the displayed frequency in 1 MHz steps, throughout the entire frequency range of the receiver. Pressing and holding either key will cause the frequency to continuously step up or down as long as the key is held depressed.

20 HF/VHF key

Selects the HF or VHF band. If the optional VC-20 VHF Converter Unit is not installed, only HF band reception will be possible. When the VHF band is selected, the frequency of the VHF band is displayed momentarily. Then the display will return to the HF band.

21 TUNING knob (VFO)

Rotate the knob to select the desired frequency. Fast tuning is possible by rotating the knob rapidly. (Except in the FM and AM modes.) This knob may also be used to select the desired memory channel. The dial drag is adjustable by holding the outside knob and turning the inside knob clockwise to increase drag, and counterclockwise to decrease drag.

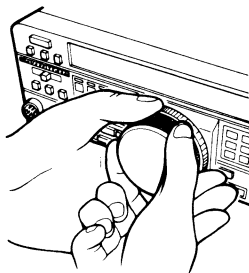

22 Program keys

- M▶V** : Used to transfer a frequency from memory to the VFO.
- SCAN** : Pressing during VFO operation will initiate program scan, and pressing during memory operation will initiate memory scan.
- CLEAR** : Used to cancel memory storage operations, or to cancel an entry during direct keyboard entry of frequency using the ENT key.
- VFO/M** : Used to switch between memory or VFO operations.
- M.IN** : Used to enter data into a memory channel.
- ENT** : Used to directly enter a frequency from the numeric keypad.

23 PHONES jack

Output terminal for headphones.

24 REC (Recording) jack

This terminal may be used for recording broadcasts on tape.

25 CLOCK and TIMER function switches

See page 25.

26 DIM (Dimmer) switch

For operator convenience, this switch selects either high or low intensity of both the digital display and meter illumination.

27 VOICE switch

When the optional VS-1 Voice Synthesizer Unit is installed the operating frequency will be announced whenever the VOICE switch is depressed. For a dial frequency of 14.200.00 the frequency will be announced as: "one", "four", "point", "two", "zero", "zero", "zero", "zero". Press this switch again to stop the announcement.

A. Display Panel

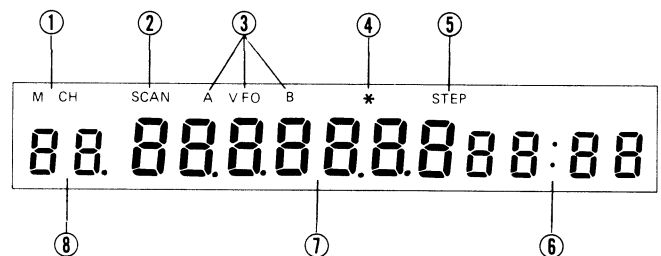

- ① **M CH display** : Turns ON during a Memory Channel operation.
- ② **SCAN display** : Turns ON during scanning.
- ③ **VFO A/B display** : Turns ON when VFO A (or VFO B) operates.
A (or B) display : Indicates the VFO which was operating before switching to memory Channel operation.
- ④ *** display** : Turns ON while the TIMER operates.
- ⑤ **STEP display** : Turns ON while the STEP key is ON.
- ⑥ **Time display** : Indicates current time.
: display : Steady when the CLOCK does not operate; blinks when CLOCK operates.

⑦ **Frequency display** : Frequency of the VFO or the Memory Channel is displayed. Frequency is expressed in 10 Hz steps (100 Hz for VHF band).

Timer operation display : When the ON TIME or OFF TIME switch is pressed, the Frequency display changes to indicate timer operational status display (ON/OFF and time).

⑧ **Memory Channel number display** : Memory Channel Number is displayed.

Clock number display : When the POWER switch is turned OFF, C1 (CLOCK 1) or C2 (CLOCK 2), whichever is selected by the CLOCK SELECTOR switch, is displayed. When the CLOCK SELECTOR switch is turned OFF, nothing will be displayed.

B. Selectivity

OPTIONAL FILTER COMBINATION	SELECTIVITY SWITCH POSITION	MODE KEY					
		USB	LSB	CW	FSK	AM	FM
N : None M1 : None	AUTO	2.4 kHz				6 kHz *	12 kHz
	N	2.4 kHz					
	M1	2.4 kHz					
	M2	2.4 kHz					
	W	6 kHz *					
N : None M1 : YK-88SN	AUTO	2.4 kHz		1.8 kHz		6 kHz *	12 kHz
	N	1.8 kHz					
	M1	1.8 kHz					
	M2	2.4 kHz					
	W	6 kHz *					
N : YK-88C M1 : None	AUTO	2.4 kHz		500 Hz		6 kHz *	12 kHz
	N	500 Hz					
	M1	2.4 kHz					
	M2	2.4 kHz					
	W	6 kHz *					
N : YK-88CN M1 : None	AUTO	2.4 kHz		270 Hz		6 kHz *	12 kHz
	N	270 Hz					
	M1	2.4 kHz					
	M2	2.4 kHz					
	W	6 kHz *					
N : YK-88C and M1 : YK-88SN	AUTO	2.4 kHz		500 Hz		6 kHz *	12 kHz
	N	500 Hz					
	M1	1.8 kHz					
	M2	2.4 kHz					
	W	6 kHz *					
N : YK-88CN and M1 : YK-88SN	AUTO	2.4 kHz		270 Hz		6 kHz *	12 kHz
	N	270 Hz					
	M1	1.8 kHz					
	M2	2.4 kHz					
	W	6 kHz *					
N : YK-88CN and M1 : YK-88C	AUTO	2.4 kHz		270 Hz		6 kHz *	12 kHz
	N	270 Hz					
	M1	500 Hz					
	M2	2.4 kHz					
	W	6 kHz *					

*: When the YK-88A-1 Crystal Filter is installed in the filter for W position, selectivity will not be changed, but the shape factor will be improved.

4-1-2. Rear panel

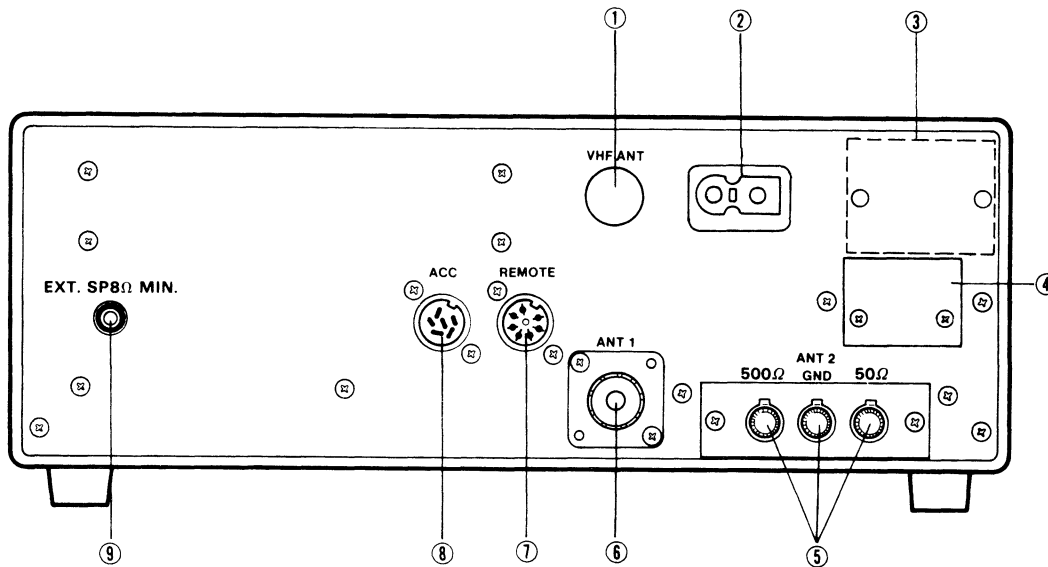

① VHF ANT connector (Optional VC-20 VHF Converter Unit is required.)

Installation area for the VHF antenna connector.

② AC power connector

For connection of the supplied AC power cable.

③ AC voltage selector switch (Except U.S.A. version)

Refer to the "SAFETY" section on page 2.

④ DC power connector (Optional DCK-2 DC Operation Kit is required.)

Installation area for the DC power connector.
This is used to connect the DC power supply.

⑤ 50Ω antenna connector

For connection of a low impedance antenna.

GND terminal

Ground terminal. The ground cable should be as short as possible. Select a good ground point.

500Ω antenna connector

Connect a high impedance long-wire antenna.

⑥ ANT 1 (Antenna) connector

This UHF connector should be attached to a suitable antenna for receiving. The antenna cable should be 50-ohm coax, terminated with a PL-259 connector.

⑦ REMOTE connector

When the R-5000 is used with a transmitter or transceiver, the REMOTE connector provides a mute pin to inhibit R-5000 audio output during transmission and an external timer control pin to operate external devices such as a tape recorder using the R-5000's timer. (Refer to pages 11 and 27 for the details.)

⑧ ACC jack

Used for connection of the 6-pin DIN connector supplied with the optional IF-232C Interface Unit.

⑨ EXT. SP (External Speaker) jack

This jack is for connection of an external speaker. Use an 8-ohm external speaker.

4-2. RECEIVE

4-2-1. Microprocessor back-up battery

The R-5000 has a rechargeable back-up battery which is charged automatically while the AC power cable is connected to an AC outlet. It takes about 6 hours to recharge a deeply discharged battery using the AC power cable. If you suspect the battery is not charged when you purchase the R-5000 or the radio performs erratically, perform the "A = B (reset)" procedure described in section 4-2-2. The battery will last about 10 days with the AC power cable disconnected.

4-2-2. Microprocessor reset

When the microprocessor has functioned erroneously or when installing the transceiver, switch on the power with the A = B key pressed.

Note:

The microprocessor can be easily reset. However, only perform this operation when necessary since the contents of the operated programmed memory are cleared by resetting. It can take a little while to reprogram 100 memory channels!

4-2-3. Beep tones

Audible confirmation of microprocessor functions is provided in the form of a series of audio beeps.

Beep tone	Indication
1 short beep	When the following keys are pressed: ANT 1, ANT 2, A/B, F. LOCK, STEP, A = B, M ▶ V, SCAN, CLEAR, M. IN (When the Memory Scroll mode is selected.), ENT, HF/VHF, 1 MHz (UP/ DOWN)
1 long beep	When the M. IN key is pressed again to enter the data.
4 short beeps	1. When a frequency outside the operating frequency range is entered using the ENT key. 2. When the SCAN key is pressed and the receiver is unable to scan. 3. When the VHF band is selected using the HF/VHF key in the event the VC-20 VHF Converter Unit is not installed.

4-2-4. Audible mode announcement

When a Mode key is pressed, the first character of the mode is sounded in Morse code thru the speaker. If the FSK mode key is pressed, R for RTTY instead of FSK will be announced.

Mode	Morse Code
USB	— — — —
LSB	— — — —
CW	— — — —
AM	— — — —
FM	— — — —
FSK (RTTY)	— — — —

4-2-5. Receiving

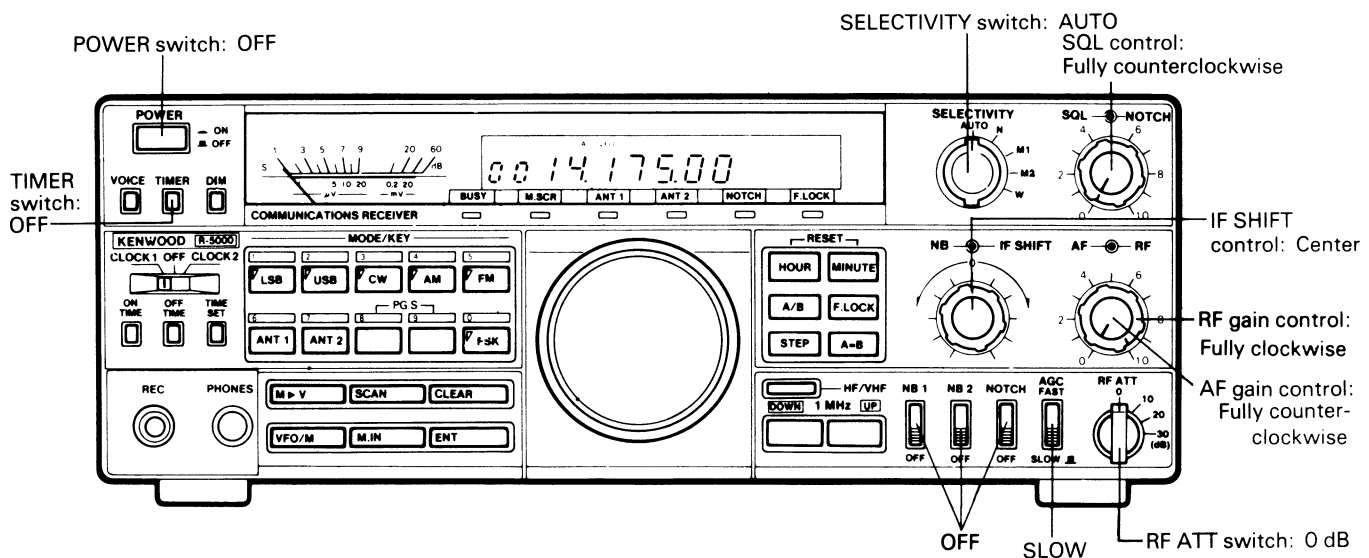

1. Preset the controls as shown in the accompanying illustration.
2. Place the POWER switch ON.
3. The meter will illuminate and a frequency will appear in the display.

Notes:

1. If the M. CH indicator lights, press the VFO/M key to select VFO operation.

2. If the F. LOCK indicator lights, press the F. LOCK key to unlock the radio.
4. Select the desired mode using one of the MODE keys.
5. Adjust the AF gain control for the desired volume.
6. Press the 1 MHz (UP/DOWN) key to select the desired frequency band.
7. Slowly rotate the TUNING knob until the desired signal can be heard clearly.

Note:

The desired receive frequency can also be entered directly by using the Numeric Keypad. For details of this operation please refer to the section 4-2-8 "Direct keyboard frequency entry".

4-2-6. Frequency step

1. The frequency step is set automatically depending on the mode that has been selected. Different steps can be set by using the STEP key. The relationship between mode and step is shown below.

The step size in which frequencies are changed by the TUNING knob can be changed by the MODE key and/or the STEP key.

Frequency Step

Mode STEP key	AM		USB/LSB/ CW/FSK		FM	
	OFF	ON	OFF	ON	OFF	ON
Frequency step	1kHz	100Hz	10Hz	100Hz	5kHz	2.5kHz
One revolution of TUNING knob (Approx.)	20kHz	50kHz	10kHz	50kHz	100kHz	50kHz

When a 10 Hz or 100 Hz frequency step is selected rapid tuning is possible by rotating the TUNING knob quickly.

When the TUNING knob is rotated at about 3 revolutions a second a geometric increase in the tuning step occurs, that corresponds to the speed of dial rotation.

2. This geometric increase occurs in 10 Hz steps in the LSB, USB, CW, or FSK mode and with the STEP key OFF and in 100 Hz steps in the LSB, USB, CW, FSK, AM, and with the STEP key ON.

4-2-7. Dual digital VFO's

Operational convenience can be enhanced thru the use of both VFO A and VFO B.

Two VFO's are provided to allow you to change frequencies rapidly. You could set one VFO to the lower tuning range and the other VFO to the upper tuning limit. You can set either VFO to any frequency you desire.

When the VC-20 VHF Converter Unit is installed you will have 4 effective VFO's. VFO A and VFO B for HF and VFO A and VFO B for VHF.

(a) A = B key

Depressing this key causes the data contained in the inactive VFO (the VFO that is not currently being displayed) to change to the same data contained in the active VFO (the one currently displayed). Both the frequency, mode and antenna selection are changed.

For example:

VFO A is set at 7 MHz in LSB, and VFO B is 21 MHz in USB. VFO A is the active VFO (show on the display). Depressing the A = B key will cause VFO B to change to 7 MHz in LSB.

In the HF position, the A = B key matches HF VFO A to HF VFO B; in the VHF position, it matches VHF VFO A to VHF VFO B.

Note:

Data can not be transferred between HF and VHF bands.

(b) A/B key

Allows selection of the desired active VFO. Each time this key is depressed the active VFO will alternate between VFO A and VFO B.

In the HF position, the A/B key functions on the HF VFO's only; in the VHF position, it functions on the VHF VFO's only.

4-2-8. Direct keyboard frequency entry

Direct keyboard entry of the frequency is possible using the Numeric Keypad on the R-5000. This allows rapid changes in frequency without the delays encountered when using other tuning methods.

1. Select the VFO mode.
2. Press the ENT key. The display will indicate.

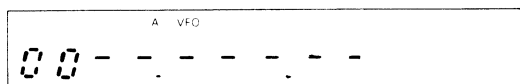

3. Enter the desired operating frequency from Most Significant Digit to the Least Significant Digit. You do not have to enter trailing zeros, but you must enter leading zeros. (03.500.00MHz).

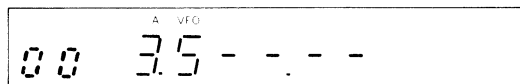

4. After the least digit has been entered press the ENT key again to signify you want the radio to change frequency. If you entered the frequency down to the nearest 10 Hz a beep will sound and the radio will automatically change to the new frequency without the need of pressing the ENT key for the second time.

For example:

To enter 14.200.00 MHz there are two methods:

Method one: Press [ENT], [1], [4], [2], [ENT].

Method two: [ENT], [1], [4], [2], [0], [0], [0], [0].

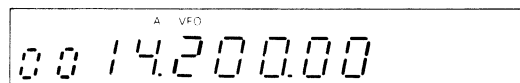

Note:

Attempting to enter a frequency outside the tuning range of the radio will cause the display to return to the frequency of operation that was in use before the ENT key was pressed.

5. If you make a mistake while entering the frequency and have not yet pressed the ENT key, or entered the final digit, you may cancel the input by pressing the CLEAR key.
6. To the display shown before the ENT key was pressed. For the VHF range, a "1" (corresponding to 100 MHz) is displayed automatically. You can enter the frequency starting from the 10 MHz digit just as for the HF range.

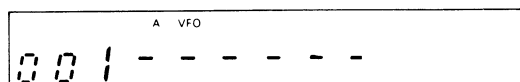

4-2-9. CW zero-beat operation

1. When an optional filter is not used, tune the TUNING knob so that the receive beat frequency is approximately 800 Hz.
2. When an optional CW filter is installed the simplest method to use is to adjust the TUNING knob for maximum S-meter deflection.

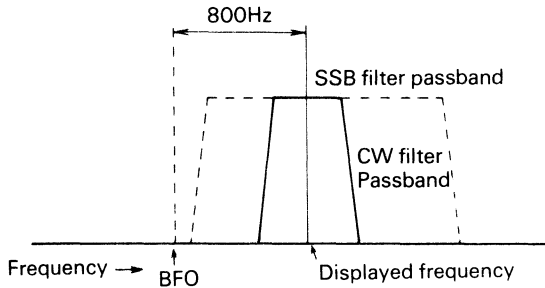

4-2-10. FSK operation (Radio teletype).

In the FSK mode, the R-5000 is automatically set for "High Tone and Narrow Shift (170 Hz) operation. The accompanying diagram illustrates the relationship between the carrier and the passband width. The demodulated AFSK (Audio Frequency Shift Keying) signal is sent from the REC jack on the front panel.

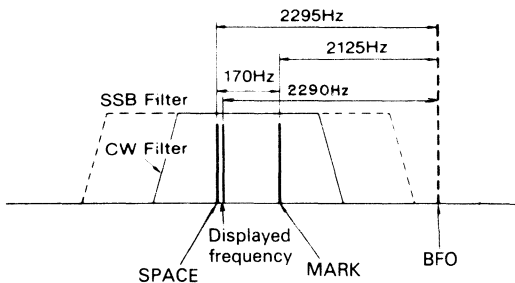

Frequency relationship

Notes:

1. An RTTY terminal is required to decode and display/print the RTTY signal.

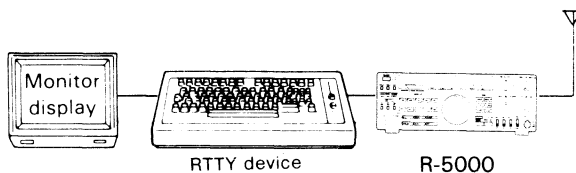

2. Because the digital VFO resolution is 10 Hz, the displayed frequency may deviate 5 Hz from the space signal frequency, but this should present no problem in actual operation.
3. If you are using a low tone terminal unit, turn the tuning knob to lower the beat frequency then turn the IF SHIFT knob counterclockwise until the S-meter no longer fluctuates.

4. To receive a wide shift signal, set the SELECTIVITY switch or M1 or M2. To receive a wide shift, high tone signal, turn the IF SHIFT knob clockwise until the S-meter no longer fluctuates.
5. To receive AFSK (F2) signals, put the R-5000 in the FM mode.

4-2-11. Receiving FAX (Facsimile) and SSTV (Slow Scan Television)

Select the MODE key to match the receiving mode. Connect the modulator, decoder, or other terminal unit to the REC jack on the front panel. For more detailed information, refer to the instruction manual supplied with the terminal equipment.

4-3. MEMORY

The R-5000 incorporates a convenient 100 channel memory that can be used to store and recall commonly used frequencies. These channels can be subdivided into 10 user-defined groups to tailor the R-5000 for optimum operation in a particular application. You can, for instance, assign channels 10 through 19 to the 160 meter band, channels 20 through 29 to the 80 meter band, channels 30 through 39 to the 40 meter band (LSB), channels 40 through 49 to the 20 meter band (USB), channels 50 through 59 to the 15 meter band, channels 60 to 69 to the 10 meter band (FM), channels 70 through 79 to the 12 meter band, and channels 80 through 89 to various shortwave bands. After completing channel assignments, you can then use the memory scan function to automatically recall the stored frequencies on a group basis. HF or VHF frequencies can be stored in any memory location.

4-3-1. Memory entry

1. With the R-5000 in the VFO mode, select the desired operating frequency, mode and antenna number as described in previous sections.

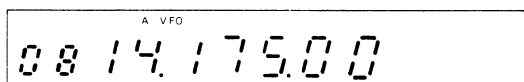

2. Press the M.IN key. The radio will enter the Memory Scroll (M.SCR) mode. The current memory channel number (M.CH), frequency, mode and antenna will be displayed, but the actual operating frequency and mode will remain unchanged allowing uninterrupted reception.

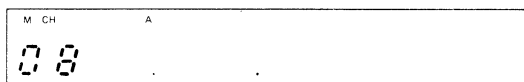

3. Select the desired memory channel using one of the three methods described below.

- (1) Turn the TUNING knob until the desired channel number is displayed (One revolution of the knob cover about 20 channels.)

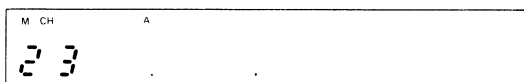

- (2) Enter a two digit channel number using the Numeric Keypad, being sure to include the leading zero for channels 00 through 09. Pressing the CLEAR key before pressing the second digit will return you to the original channel.
 - (3) Use the UP/DOWN keys to scroll thru the different memory positions.
4. When the desired memory channel is found and displayed, press the M.IN key again. The current frequency, mode and antenna number will be stored, the Memory Scroll mode will be cancelled, and the R-5000 will return to the operating mode and frequency that was displayed before the M.IN key was pressed initially.

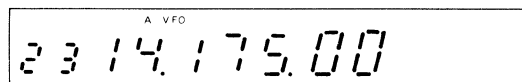

Note:

If you decide not to enter the information into memory press the CLEAR key to return to the original frequency, mode and antenna.

4-3-2. Memory Channel Recall

Fixed channel type recall is possible when using the VFO/M key to recall memory channel information. The stored frequency cannot be changed.

The following procedure shows how to recall a channel.

1. During VFO operation, press the VFO/M key to initiate Memory Channel operation. This causes the Memory Channel to return to the status (antenna number, mode, and frequency) prior to the Memory Channel operation. The VFO selected (A or B) before changing to the Memory Channel operation will be displayed.

Example:

When 14.175 MHz is stored in Memory Channel 23.

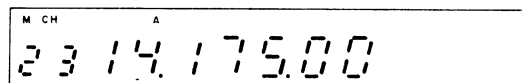

2. Select a Memory Channel by using the TUNING knob, Keypad, or MHz (UP/DOWN) switch.

Example:

When Memory Channel 68 (28.800 MHz) is selected.

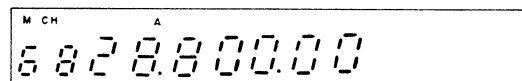

3. If you press the VFO/M key again, the original VFO operating information will be restored.

Note:

The only way to tune is to transfer the data to the VFO.

4-3-3. Clearing a Memory Channel

Data may be erased by depressing the ENT key while depressing the CLEAR key.

A Memory Channel may be cleared by the following procedure.

1. Enter the Memory Channel mode by pressing the VFO/M key.
2. Select the channel number that you want to clear using any of the methods previously described.
3. Press and hold the CLEAR key.
4. Press the ENT key. Then release both keys. The radio will beep. The display will blank and no sound will come from the speaker.
You may now return to the VFO mode by pressing the VFO/M key.

4-3-4. Memory Channel Scroll

The following procedure provides a method to check a Memory Channel Frequency without changing or losing the current receive frequency.

1. During Memory Channel operation, press the VFO/M key to change to select VFO operation.
2. Press the M IN key once to initiate memory Scroll. The M.SCR indicator lights, and the memory Channel Frequency is displayed. (Although the displayed frequency will change, actual reception will be at the previous frequency (that is, the frequency before the M IN key is pressed) of the VFO.) Memory shifting can also be done by pressing the M▶V key.
3. Select a Memory Channel using the TUNING knob, Numeric Keypad, or MHz (UP/DOWN) key. The frequency stored in the Memory Channel will be displayed.

Note: _____

Mode and antenna number data are not displayed.

4. To clear Memory Scroll operation, press the CLEAR key or the M IN key again to restore Memory Channel operation.

4-3-5. Transferring memory information to the VFO.

The following procedure transfers the contents of the Memory Channel to the VFO.

1. In the VFO mode, press the VFO/M key to set the Memory Channel mode. This returns the Memory Channel to the status (antenna number, and frequency) prior to the VFO operation. The VFO selected (A or B) before setting the Memory Channel mode is displayed. To transfer the memory contents to a VFO which is not currently operating, press the A/B key before pressing the VFO/M key, in order to switch to the desired VFO.

Example:

When 14.175 MHz is stored in Memory Channel 23.

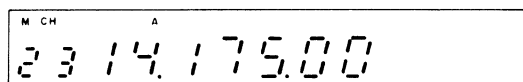

2. Select the desired memory Channel by using the TUNING knob, Numeric Keypad, or MHz (UP/DOWN) key.

Example:

Memory Channel 16 containing 21.225 MHz is selected.

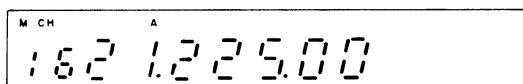

Press the M▶V key. The contents of the Memory Channel will be transferred to the VFO and operation changes to the VFO mode.

Notes: _____

1. When the M▶V key is pressed, the contents of the VFO are cleared but the contents of the Memory Channel will not be cleared.
2. If nothing is stored in the selected Memory Channel, only the channel number is displayed; no transfer is carried out.

Example:

Frequency (21.225 MHz) is transferred to the VFO. When the TUNING knob is turned, the frequency changes from this new frequency.

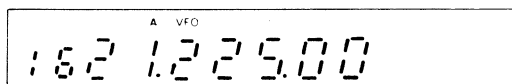

Note: _____

Contents of a Memory Channel can be transferred to the VFO without regard to HF or VHF operation.

Notes: _____

1. Data in the VFO is replaced by the memory data. memory data is not lost during this operation.
2. In the Memory Scroll mode (M. SCR LED is lit), memory channel information can also be transferred to the VFO.

4-4. SCAN

Both Memory Scan and Program Scan are possible. In the AM and FM modes, scanning stops when the BUSY indicator lights. (This is known as Time Operated (about five seconds) Scan.) Time Operated Scan can be changed to Carrier Operated Scan (in which scanning stops when an AM or FM signals is present). Consult the authorized KENWOOD dealer where you purchased the radio from for modification information.

Notes:

- The BUSY indicator lights in the following cases:
 - When the SQL knob is turned counterclockwise from the point at which the squelch circuit mutes the audio (threshold).
 - When an input signal is present.
- If the present mode is other than AM or FM, Time Operated Scan will be applied regardless of where the SQL knob is set or whether input signals are present or not.

4-4-1. Memory scan

The R-5000 stops on a busy channel in the AM or FM modes. The radio will remain on the busy channel for approximately 5 seconds and then start to scan again.

To initiate memory scan of all memory channels

- Press the VFO/M key to select the Memory Channel mode.
- Press the SCAN key. Scan will begin at memory channel 00, or the lowest numbered channel containing data.
- You can stop scanning by pressing the CLEAR key.
- To resume scan press the SCAN key again. Scan will resume from the point that you stopped.

To initiate memory scan of specific memory channel groups

The 100 memory channels are divided into 10 groups (00 to 09, 10 to 19, ..., 90 to 99). All Memory Channels in the groups are scanned.

- Select Memory Channel operation.
- While pressing the SCAN key, select the desired group(s) number using the Numeric Keypad. A maximum of ten groups can be selected. Scanning will proceed from lower numbered groups to higher numbered groups regardless of the sequence of selected group numbers.

Group Number	Memory Channel	Group Number	Memory Channel
0	0 ~ 9	5	50 ~ 59
1	10 ~ 19	6	60 ~ 69
2	20 ~ 29	7	70 ~ 79
3	30 ~ 39	8	80 ~ 89
4	40 ~ 49	9	90 ~ 99

Note:

All scanning groups (0 to 9) are selected upon shipment from out factory and when the microprocessor is reset.

- When you release the SCAN key, scanning starts.

Notes:

- If no valid memory channel exists in a selected group, scanning will be automatically reset and memory channel restarts. A valid memory channel is one channel which is not locked out and in which a frequency is stored.

- Locked-out Memory Channels will be skipped. (See "Memory Channel Lockout" section on Page 24.)

Example 1:

When group number 2 is selected:

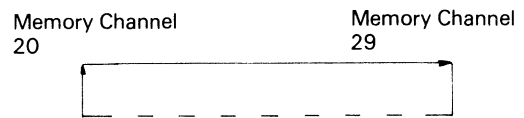

Example 2:

Group numbers 8 and 3 are selected and numbers on the Numeric keypad are pressed in that sequence.

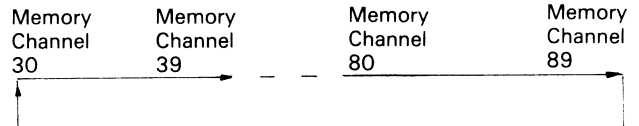

- To resume scan, press the SCAN key again.
- To clear scanning, press the CLEAR key.

Note:

The R-5000 microprocessor remembers the various scan parameters that you have specified and will follow whatever you have entered the next time you press the SCAN key.

Example:

Previously programmed memory scan data was to scan Memory Channels 20-29 and 40-49.

To scan this same range again simply press the SCAN key.

The R-5000 will continue to execute scan according to the above parameter until you manually change the information. This saves a lot of key strokes if you always scan the same ranges, etc.

4-4-2. Program scan

In the program scan mode the R-5000 will scan from channel 8 to channel 9 of the current memory channel group. This allows you to program up to 10 different scan ranges; 18 - 19, 28 - 29, 38 - 39.... The program scan step size is determined by the mode in channel 8 and the STEP key. To specify which group to scan press the M. IN key to enter the Memory Scroll mode. Select the desired memory channel group using any desired method, you can select any memory channel of the desired group. After the group has been specified press the CLEAR key to return to the VFO mode. Scan will begin at the frequency specified in memory X 8 and proceed up or down, depending on the frequency entered into channel X 9. Scan will go up if the frequency in X 9 is greater than X 8 and down if channel X 9 is less than X 8.

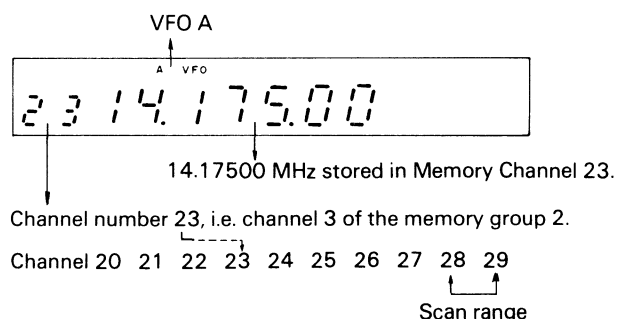

Notes:

1. If you try to perform program scan in a memory group that does not have data in channels 8 and 9 an error tone will sound.
2. No scanning will be performed if Memory Channel 8 and Memory Channel 9 in the selected group are not stored in the HF band or the VHF band.

When the AM or FM mode key is selected, the R-5000 will stop on a busy channel during scan operations. When an incoming signal is detected during frequency scanning the BUSY indicator will light. In order for this function to operate the SQL control must be adjusted to the threshold point. The R-5000 will remain on a station approximately 5 seconds and then resume Time Operated scan.

Note:

All modes other than AM and FM do not stop on a busy channel.

To initiate the Program Scan.

1. During memory Channel operation, press the VFO/M key to return to VFO operation.

Example:

To switch to VFO operation (VFO A) from Memory Channel 14.175 MHz.

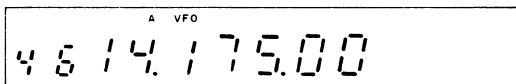

2. Select a group which contains the Memory Channel you want to scan using the VFO knob.

Example:

When you want to scan Memory Channel 29 (14.100.00 MHz) from Memory Channel 28 (14.010.00 MHz, CW mode), select one Memory Channel from Memory Channel 20 to 29. (The figure below shows Memory Channel 23.)

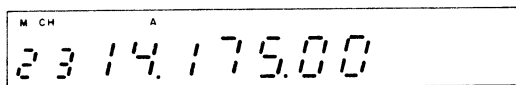

3. Press the SCAN key to start scanning.

Example:

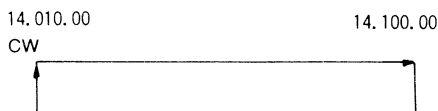

4. To clear the scanning, press the CLEAR key.

4-4-3. Scan speed

The microprocessor automatically selects the scan speed best suited for the mode and step frequency. You can use the STEP key during scanning to vary the scan speed.

4-4-4. Memory channel lockout

This receiver has a memory channel lockout function which allows you to temporarily skip unwanted memory channels during memory scan. Locking out unwanted channels will help to increase the effective scan speed.

1. Press the VFO/M key to enter the Memory Channel mode.
2. Select the memory channel that you want to skip using the Numeric Keypad, the TUNING knob, or the UP/DOWN keys.
3. Press the CLEAR key.

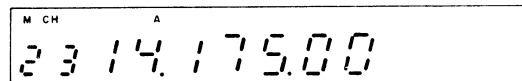

4. A decimal point will appear in the M. CH display to indicate that the channel will be skipped.

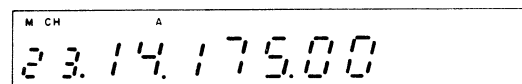

5. To cancel the lockout, select the desired channel and then press the CLEAR key. The decimal point will go out indicating that the channel will again be scanned.

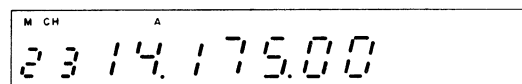

4-5. CLOCK AND TIMER

4-5-1. Clock and timer function switches

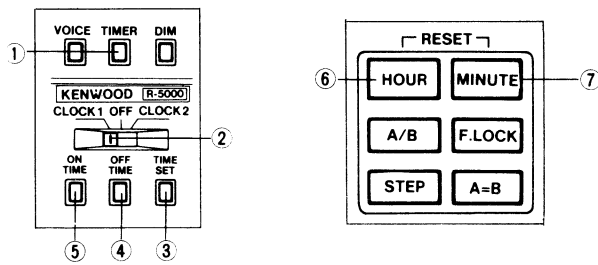

① TIMER switch

This switch controls the time operation. When the TIMER switch is ON, the timer has priority over the POWER switch. If the radio will not turn on, check this switch!

② CLOCK1/OFF/CLOCK2 switch

CLOCK 1 : Use this position, to display local time. Timer operation is controlled by local time.

OFF : In this position, nothing is displayed.

CLOCK 2 : In this position, a second time zone may be entered for display. Timer-ON/OFF operation is not controlled by clock 2 time. Set this clock to GMT or any other time zone that you wish to monitor.

③ TIME SET switch

This switch is used to set the timer and the clock time.

④ OFF TIME switch

Use this switch to display the time that the radio has been programmed to turn OFF.

⑤ ON TIME switch

Use this switch to display the time that the radio has been programmed to turn ON.

⑥ HOUR key

Sets the hours.

⑦ MINUTE key

Sets the minutes. Pressing this switch simultaneously with the HOUR switch resets the clock or timer.

4-5-2. Clock

The R-5000 has two independent 24-hour clocks, CLOCK 1 and CLOCK 2. The clock times may be viewed with the POWER switch ON or OFF. Both methods are described below.

A. Clock selection

CLOCK 1 or CLOCK 2 is selected by the slide switch on the front panel.

a. When the POWER switch is ON.

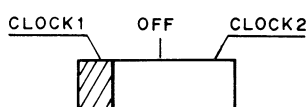

(Example)

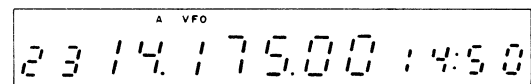

CLOCK 1 indicates 14:50.

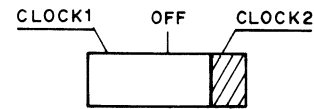

(Example)

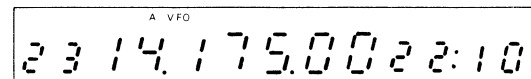

CLOCK 2 indicates 22:10.

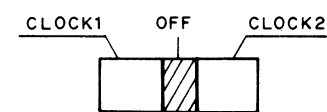

(Example)

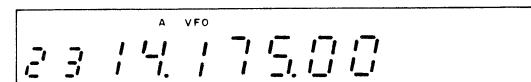

With the switch in this position, the clocks are operating, even though there is no time display.

b. When the POWER switch is OFF.

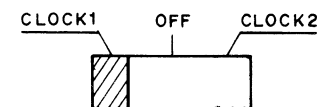

(Example)

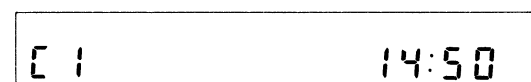

C1 appears in the channel display section, indicating that the time shown is for CLOCK 1.

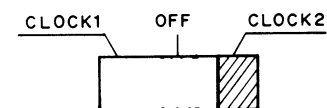

(Example)

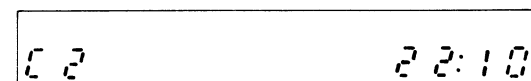

C2 appears in the display to indicate CLOCK 2 is being displayed.

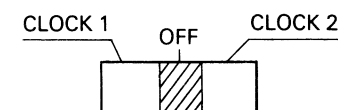

In this position the clock display is OFF, so nothing is displayed.

B. Time set

1. Select the CLOCK for which the time is to be set.

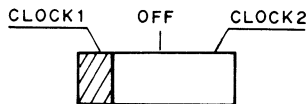

2. Press the TIME SET switch.
3. Simultaneously press the HOUR and MINUTE keys to stop the clock.

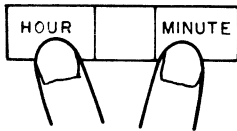

The colon on the clock display lights continuously, indicating that the clock has stopped and that you can now begin programming.

(Example)

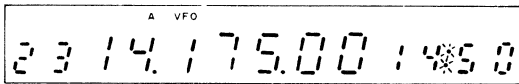

4. Set the desired time using the HOUR and MINUTE keys.

(Example)

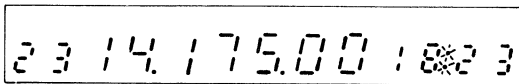

5. Turn the TIME SET switch to OFF; the colon on the clock display starts blinking, indicating the new time.

Synchronizing your clocks to a known time standard such as WWV or JJY.

1. Set CLOCK 1 according to the instructions above.
2. Set the time of CLOCK 2 so that it is one minute ahead of the time you wish to begin.
For example, the present time is 5:59 UTC and you want the synchronization to begin at 6:00 UTC, so you would set CLOCK 2 to read 6:00.
3. To start the clock you would turn the TIME SET switch OFF in synchronization with the tone signal generated by the appropriate time standard. This will automatically synchronize both CLOCK 1 and CLOCK 2 to the time standard.

Note: _____

An error of 1 minute between the minutes displayed on CLOCK 1 and CLOCK 2 may occur if both clocks are not displaying the same number of minutes, i.e. CLOCK 1 __:59:00 and CLOCK 2 __:00:00 when you set CLOCK 2.

4-5-3. Timer

A. ON TIME set

You can program the R-5000 to turn ON or OFF in synchronization with CLOCK 1. (The timer will not be controlled by the time set in CLOCK 2.)

The time programmed with the ON TIME switch is used to turn the R-5000 ON at the selected time. To set the turn on time:

1. Press the TIME SET switch.

2. Press and hold the ON TIME switch. The display will indicate:

(Example)

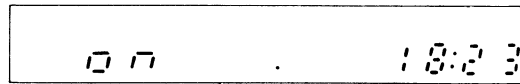

3. Set the desired time using the HOUR and MINUTE keys.

(Example)

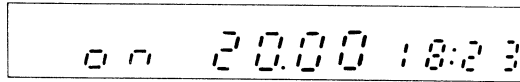

4. Release the ON TIME switch and the TIME SET switch.
5. Timer operation begins when the TIMER switch is turned ON.

Notes: _____

1. The timer will not function if the TIMER SET switch is left ON; be sure to turn the switch OFF after setting the timer.
2. If you simultaneously press the HOUR and MINUTE keys, the associated timer will be reset. (TIME ON or TIME OFF).
3. If you have not set either an ON time or an OFF time, nothing will happen when you press the TIMER switch.
4. When the TIMER is operating, a red asterisk (*) appears in the display.
5. When the TIMER is operating, the POWER switch does not function.

B. OFF TIME set

The OFF TIME turns the R-5000 OFF at the desired time.

1. Press the TIME SET switch.
2. Press and hold the OFF TIME switch; the display will indicate:

(Example)

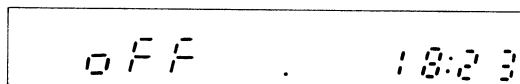

3. Set the desired time using the HOUR and MINUTE keys.
4. Release the OFF TIME switch and the TIME SET switch.
5. Timer operation begins when the TIMER switch is turned ON.

C. ON/OFF operation

If both the ON time and the OFF time are set, the ON and OFF times are synchronized with CLOCK 1. The ON/OFF cycle is then repeated daily, as long as the TIMER switch is ON.

D. Checking the programmed times

To check the programmed times, press the ON TIME or OFF TIME switch.

Note: _____

You may check the times with the POWER switch ON or OFF, but you must program the TIMER with the POWER switch ON.

E. Turning external units ON or OFF

You can use the R-5000's TIMER to turn external units such as tape recorders ON or OFF. Various pin connections for timer states are shown below.

Timer	OFF	ON
Pins 1 and 4	Open	Closed
Pins 1 and 6	Closed	Open

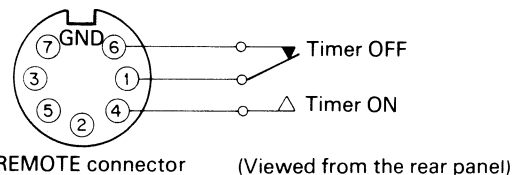

Warning: _____
 1. Never apply AC voltage to the REMOTE connector.
 2. The relay contact capacity is limited to 30 VDC, 1A.

5. MAINTENANCE

5-1. GENERAL INFORMATION

Your receiver has been factory aligned and tested to specification before shipment. Under normal circumstances, the receiver will operate in accordance with the instructions in this manual.

If your receiver fails to work, contact the authorized dealer from which you purchased it for quick, reliable repair. All adjustable trimmers and coils in your receiver were preset

at the factory and should only be readjusted by a qualified technician with proper test equipment.

Attempting service or alignment without factory authorization, may void the warranty.

When operated properly, the receiver can give years of service without requiring realignment.

5-2. SERVICE

Should it ever become necessary to return the equipment to your dealer or service center for repair, pack it in its original box and packing, and include a full description of the problems involved. Also include your telephone number. You need not return accessory items unless directly related to the service problem. If you do include accessory items please list them in your correspondence.

You may return your receiver for service to the Authorized KENWOOD Dealer from whom you purchased it. A copy of the service report will be returned with the unit. Please send the complete unit, in its original boxes and packing.

Tag all returned items with your name and amateur call, if you have one for identification.

Please mention the model and serial number of your receiver in any correspondence, whether phone or written. For future reference, record this information in the space provided on the back cover of this manual.

Service note: _____

Dear OM, if you desire to correspond on a technical or operational problem, please make your note short, complete, and to the point. And PLEASE make it readable.

Please list: Model and serial number

The question or problem you are having.

Please give sufficient detail to diagnose: other equipment in the station, meter readings and anything you feel might be useful in attempting diagnosis.

Notes: _____

1. Record the date of purchase, serial number and dealer from whom purchased.
2. For your own information, retain a written record of any maintenance performed on the unit.
3. When claiming warranty service, please include a photocopy of the bill of sale, or other proof of purchase showing the date of sale.

Caution: _____

Do not pack the equipment in crushed newspapers for shipment! Extensive damage may result, during shipping.

5-3. CLEANING

The knobs, front panel and cabinet of the receiver are likely to become soiled after extended use. The knobs should be removed from the receiver and cleaned with a neutral soap and warm water. Use a neutral soap (not harsh chemicals) and damp cloth to clean the cabinet and front panel.

5-4. IN CASE OF DIFFICULTY

The problems described in this table are failures caused in general by improper operation or connection of the receiver, not by defective components. Examine and check

according to the following table. If the problem persists, contact an authorized agent or service station.

Symptom	Probable cause	Corrective action
Indicators do not light and no receiver noise is heard when the POWER switch is turned on.	<ol style="list-style-type: none"> 1. Bad power cable or connections. 2. Blown power supply fuse. 3. The TIMER switch is ON. 	<ol style="list-style-type: none"> 1. Check cables and connections. 2. Contact the dealer. 3. Turn the TIMER switch OFF.
Nothing is displayed or wrong digits are displayed when the POWER switch is turned on.	The microprocessor may malfunction if the input voltage is too low.	<ol style="list-style-type: none"> 1. Use a step-up transformer to raise the line voltage. Use a 12V to 16V battery. 2. Turn on the POWER switch while depressing the A = B key, and then release the A = B key.
When you press the POWER switch, "15 MHz AM" is displayed ... or the receive sensitivity is low.	The backup battery is discharged.	Turn the POWER switch off with the power cable plugged into an AC outlet, to allow the backup battery to charge.
No signal is received even when the antenna is connected or the receiving sensitivity is low.	<ol style="list-style-type: none"> 1. SQL control fully clockwise. 2. SELECTIVITY switch is set to "N". 3. The RF ATT switch is ON. 4. A wrong antenna number has been assigned. 	<ol style="list-style-type: none"> 1. Turn the SQL control counterclockwise. 2. Ensure the SELECTIVITY switch is set to "AUTO". 3. Set the RF ATT switch to zero position RF ATT switch to zero. 4. Select the correct antenna.
An antenna is connected, but no signal is received and the S-meter fully deflects.	RF control is too low, decreasing the high frequency circuit gain.	Turn the RF gain control fully clockwise.
The S-meter deflects and stays at a certain position even with no signal.	<ol style="list-style-type: none"> 1. Low AC line voltage. 2. RF gain control closed. 	<ol style="list-style-type: none"> 1. Use a step-up transformer to raise the line voltage. Use a 12V to 16V battery. 2. Turn the RF gain control fully clockwise.
Signal is received, but no sound is heard.	MODE key position is incorrect.	Change the MODE key to the correct mode.
SSB received signal is extremely high cut or low cut.	IF SHIFT control is wrong adjusted.	Set the control to the center (click position).
Frequency is not changed by pressing the 1MHz (UP/DOWN) key or turning the TUNING knob.	F. LOCK key is ON.	Set F. LOCK key to OFF.
Program scan fails.	<ol style="list-style-type: none"> 1. No frequency is stored in channels 8 and 9 of the displayed channel group. 2. Both HF and VHF frequencies are stored in channels 8 and 9 of the displayed channel group. 	<ol style="list-style-type: none"> 1. Store the frequencies. 2. Store either HF or VHF frequencies, not both.
Memory scan fails.	<ol style="list-style-type: none"> 1. Nothing is stored in memory. 2. Nothing is stored in the selected memory scan group. 	Store the frequency.
Display goes out with VFO/M ON.	When nothing is stored in the memory channel, a channel is displayed and blanked with only the decimal point displayed.	
The TIMER does not work.	<ol style="list-style-type: none"> 1. The on time or off time is not set. 2. The TIME SET switch is ON. 	<ol style="list-style-type: none"> 1. Program the on time or off time. 2. Turn the TIME SET switch OFF.

6. OPTIONAL ACCESSORIES

The following accessories are available for more sophisticated operation of your receiver.

- **HS-7 MICRO HEADPHONES (16 OHMS)**
- **HS-6 COMMUNICATIONS HEADPHONES (12.5 OHMS)**

Deluxe, very light-weight headphones designed for communications equipment.

- **HS-5 COMMUNICATIONS HEADPHONES (8 OHMS)**

Headphones designed for communications equipment. These light-weight open air-type headphones remain comfortable during extended operation. Easily attached ear-pads are provided.



HS-6



HS-5

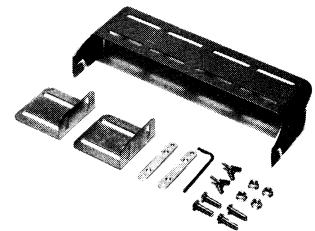

MB-430

Caution:

Optional accessories should be installed by qualified service personnel to prevent personal injury or damage to the equipment.

The following optional Crystal Filters can be used to reduce adjacent channel interference.

■ YK-88C CW FILTER

Center frequency : 8,830.7 kHz
 Passband width : 500 Hz (– 6 dB)
 Attenuation bandwidth : 1.5 kHz (– 60 dB)
 Guaranteed attenuation : More than 80 dB

■ YK-88CN CW NARROW FILTER

Center frequency : 8,830.7 kHz
 Passband width : 270 Hz (– 6 dB)
 Attenuation bandwidth : 1.1 kHz (– 60 dB)
 Guaranteed attenuation : More than 80 dB

■ YK-88SN SSB NARROW FILTER

Center frequency : 8,830.0 kHz
 Passband width : 1.8 kHz (– 6 dB)
 Attenuation bandwidth : 3.3 kHz (– 60 dB)
 Guaranteed attenuation : More than 80 dB

■ YK-88A-1 AM FILTER

Center frequency : 8,830.0 kHz
 Passband width : 6 kHz (– 6 dB)
 Attenuation bandwidth : 11 kHz (– 60 dB)
 Guaranteed attenuation : More than 80 dB

■ IF-232C INTERFACE

The IF-232C Interface is the adapter for connection between the RS-232C terminal of a personal computer and the interface terminal of the R-5000.

■ MB-430 MOBILE MOUNT

The Mobile Mount MB-430 allows easy installation and removal of the R-5000. The MB-430 can either be suspended from the dashboard or attached to the transmission tunnel or a center console. The transceiver tilt angle can be adjusted 5 steps.

■ VC-20 VHF CONVERTER UNIT

The VHF Converter Unit for the R-5000 covers the frequency range between 108 MHz and 174 MHz (with West Germany version: 144 MHz to 146 MHz).

■ IC-10 INTERFACE IC KIT

The Interface IC Kit is designed to be installed internally in the R-5000 to allow computer assisted control of various receiver operating parameters.

Control is performed thru a computer's RS-232C terminal thru the IF-232C Interface (level translator).

■ VS-1 VOICE SYNTHESIZER UNIT

When the VS-1 Voice Synthesizer Unit is installed, the displayed frequency is announced by synthesized voice.

■ DCK-2 DC OPERATION KIT

The DCK-2 is the DC power cable kit for DC operation of the R-5000.

2-pin connector manufacturer: KENWOOD CORPORATION
 Part number : E30-2055-05

7. REFERENCES

7-1. ENJOYING SW RECEPTION

ENJOYING SW RECEPTION

Every country in the world has broadcast stations, and most countries have Amateur radio stations. The earth is virtually surrounded by innumerable radio waves, providing us with information and news. Your receiver intercepts many of these transmissions.

Radio waves cover a wide range of frequencies including long-wave (LF), medium-wave (MF), and short-wave (SW) or high frequency (HF). Since short-wave signals travel around the earth, it is fun receiving exciting news and ex-

Propagation of Radio Waves By the Ionosphere

The earth is surrounded by the atmosphere. The atmospheric molecules existing between 50 km and 500 km above the earth collide with ultraviolet rays and electrons emitted from the sun, and a layer of electrons and ions is formed. This layer is called the ionosphere and it has a characteristic of refracting radio waves. Radio waves emitted from the antenna of a transmitter can be classified as surface waves and ionospheric waves. Surface waves travel along the earth directly, and are used mainly for medium frequency AM broadcast and TV and FM broadcast. Ionospheric (sky) waves travel a long distance because they are refracted repeatedly between the ionized layer and the earth. As short-wave broadcasts propagate by ionospheric waves, their signals often reach around the earth. The surface wave tends to weaken at HF and short-wave frequencies and therefore travel only a short distance, while ionospheric waves persist as the frequency increases (up to a certain point, determined by ionization intensity) and travel long distance with little path loss. Ultra high frequencies pass through the ionized layer, and thus the service area is limited to a short distance from the antenna. The ionosphere is divided into three layers, D, E and F.

The electron density in the layer is increased in steps according to the distance from the sun. High frequency waves are refracted by the F layer and travel a long distance.

The state of the ionized layer is closely associated with the relative positions of the sun and the earth and also with the activity of the sun. The D and E layers almost disappear at night, while the F layer changes in height and density depending on daytime or night time, and changes the upper frequency limit to be reflected. Occasionally, "clouds" of ions will drift through the E layer, causing strong signal propagation (called "sporadic E propaga-

tion") over several hundred miles, usually between 15 MHz and 30 MHz, and sometimes higher in frequency. Such a phenomenon also occurs with changes in seasons or rotation cycle of the sun as well as unusual activities of the sun (change in the sunspot cycle every 11 years, unexpected explosion on the sun, etc.). To cope with this, international short-wave broadcast stations change their frequencies according to seasons or directions of radio waves, or use different frequencies at the same time for broadcasting the same program.

tion") over several hundred miles, usually between 15 MHz and 30 MHz, and sometimes higher in frequency. Such a phenomenon also occurs with changes in seasons or rotation cycle of the sun as well as unusual activities of the sun (change in the sunspot cycle every 11 years, unexpected explosion on the sun, etc.). To cope with this, international short-wave broadcast stations change their frequencies according to seasons or directions of radio waves, or use different frequencies at the same time for broadcasting the same program.

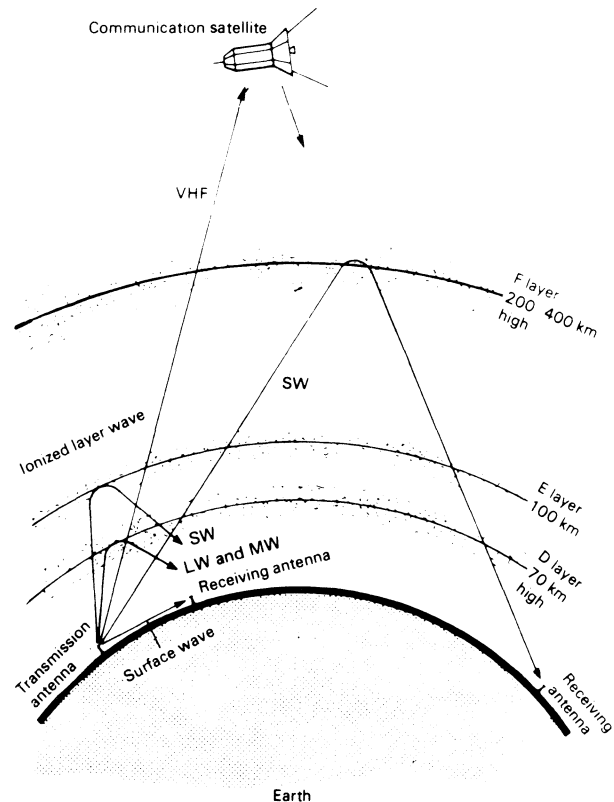

Frequency Distribution in the Broadcast and Amateur Bands.

The R-5000 receiver covers from 100 kHz to 30 MHz, to receive international broadcast and communication services.

As shown in the Frequency Allocation Chart, broadcast and Amateur radio station frequencies are allocated in specific bands expressed in megahertz (MHz) or wave-length in meters (m). Also in the chart, the frequencies of "other stations" are assigned for fixed station business use, marine mobile, aviation mobile, land mobile, radio beacon stations, etc. The following relationship exists between frequency and wave length.

$$\text{Wave-length (m)} = \frac{300}{\text{Frequency (MHz)}}$$

$$= \frac{300,000}{\text{Frequency (kHz)}}$$

$$\text{Frequency (MHz)} = \frac{300}{\text{Wave length (m)}}$$

As will be seen from this relationship, the 31 m band and 9 MHz band, for example, are the same shortwave broadcast band, covering the range of 9,500 kHz to 9,775 kHz.

Note:

Radio stations throughout the world are listed in the **WORLD RADIO TV HANDBOOK** or similar publications.

* (With the Australia version from 2 to 30 MHz; with the West Germany version, from 150 kHz to 26.2 MHz)

RADIO FREQUENCY ALLOCATION

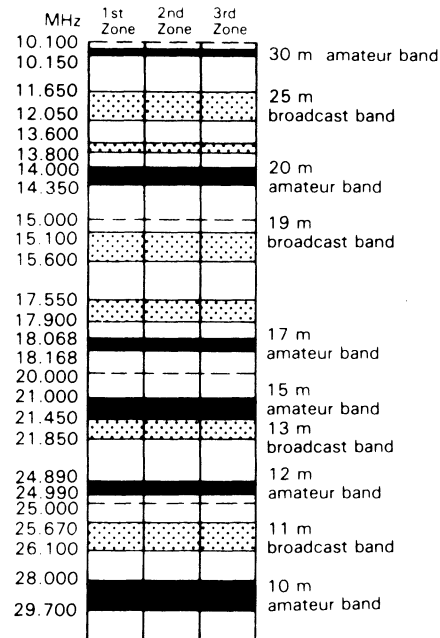
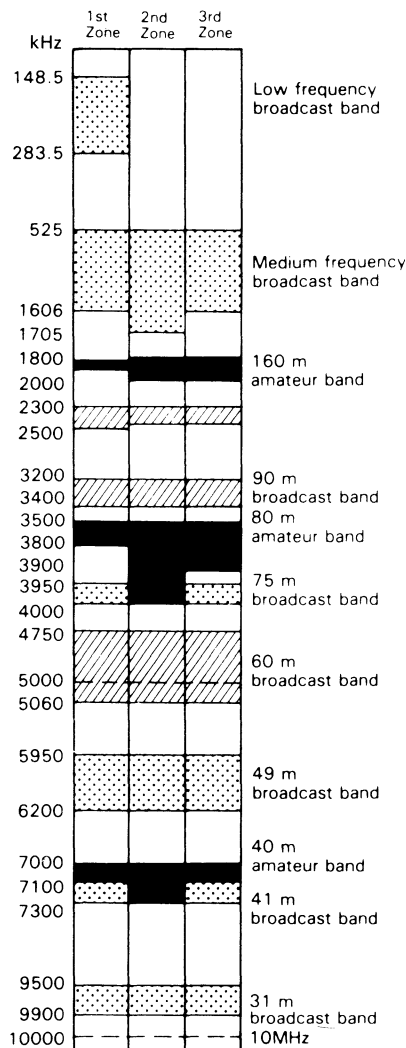

- 1st Zone:** Europe and Africa (Soviet Russia, Turkey and Mongolia included)
- 2nd Zone:** South and North America
- 3rd Zone:** Asia and Oceania (Soviet Russia, Turkey and Mongolia excluded)

● In some countries, frequencies allocations do not accord with this table.

- Standard time frequency
- ▨ Tropical broadcast band
- ▩ General broadcast band
- Amateur band
- Other stations

Radio Frequency Allocation

7-2. ANTENNA AND GROUNDING

7-2-1. Antenna

The following describes various antenna types and their installation.

● Long Wire Antenna

This is the simplest antenna, using about 30 ~ 100 feet (10 ~ 30 m) of wire installed between poles, trees or other convenient supports. The antenna wire should be heavy 8 gauge vinyl insulated, stranded wire or 4-gauge copper wire or copperweld. This type of antenna must be installed horizontally to a length of 60 feet (20 m) or more, and be positioned as high as possible. Note that it should be as far away as possible from AC power lines, buildings, trees and other objects.

Fig. 7-1 shows an inverted L antenna. Other antenna types such as sloping, vertical, etc. are also possible.

A long-wire antenna, when installed in an open area, is suitable for all-band operation.

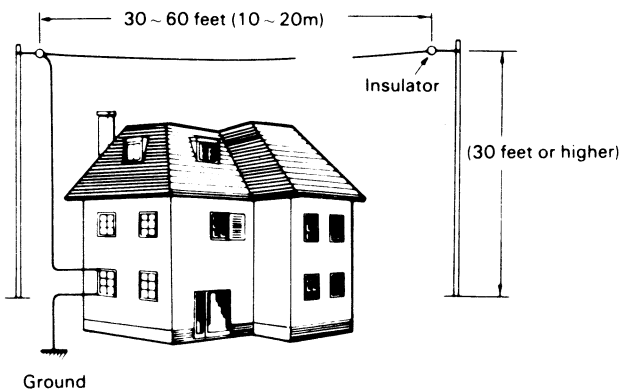

Fig. 7-1

● Doublet Antenna

This type of antenna is suitable for reception of a specific band.

The relation between the overall length "L" and the tuned frequency is:

$$L \text{ (m)} = \frac{143}{\text{Freq (MHz)}} \quad K \text{ (feet)} = \frac{468}{\text{Freq (MHz)}}$$

This antenna is directional. Signal strength is maximum when the antenna is at a right-angle (broad-side) to the desired signal and the frequency for which the antenna is cut. It must be used with a 75-ohm coaxial feeder. (See Fig. 7-2)

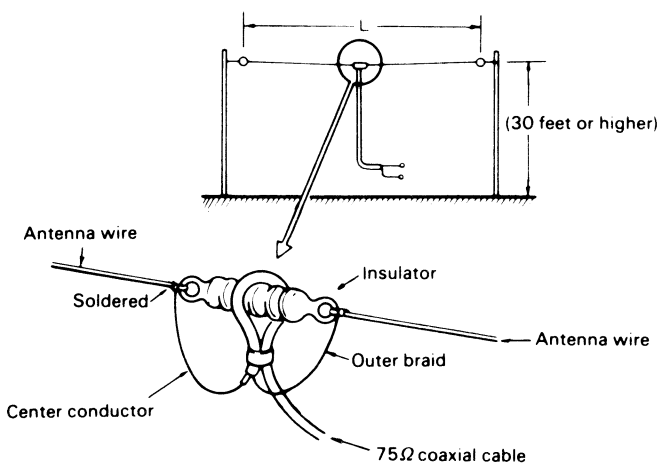

Fig. 7-2

● Inverted V Antenna

This is a modified doublet antenna, designed to be installed on a single pole or support. The characteristics of this antenna are almost the same as those of a doublet. The overall length "L" is a little more than that of a doublet, and is computed thus:

$$L \text{ (m)} = \frac{148}{\text{Freq (MHz)}} \quad L \text{ (feet)} = \frac{486}{\text{Freq (MHz)}}$$

(See Fig. 7-3)

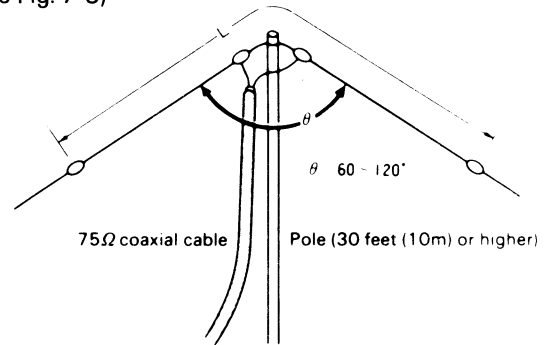

Fig. 7-3

● Multiband Antenna

This antenna uses more than one doublet for multiband reception. The overall length "L" is the same as that of the doublet. If the lengths L1, L2 and L3 are cut for 7 MHz, 14 MHz and 28 MHz, then L1 is tuned to 21 MHz (3 x 7 MHz), permitting reception on 4 amateur bands 7 ~ 28 MHz. When used only for reception, this antenna will cover the 6 ~ 30 MHz SW bands. (See Fig. 7-4)

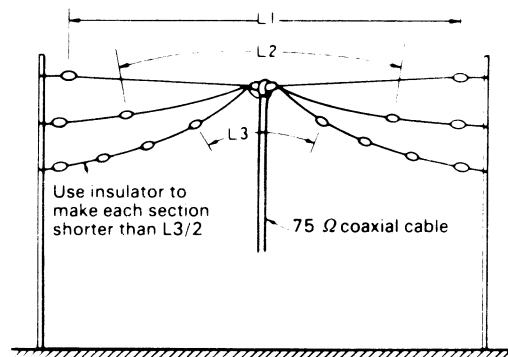

Fig. 7-4

● Trap Vertical Antenna

Antennas designed exclusively for BCL are available commercially, or may be built yourself. Antennas designed for HAM band (3.5 ~ 28 MHz or 7 ~ 14 MHz) operation will provide satisfactory broadcast reception for stations near the SW bands. Antennas of this type are most suitable for the listener who does not have enough space for installation of a doublet or long-wire antenna. (See Fig. 7-5)

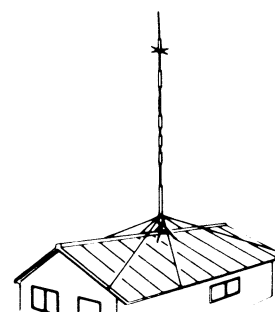

Fig. 7-5

● **Yagi Antenna**

The Yagi antenna is best suited for reception in a specific band. This antenna features excellent directivity; it provides high gain and minimizes interference when properly installed. Yagi antennas commercially available are designed only for HAM band reception. For SW reception, it will be necessary for you to construct such antennas yourself. (See Fig. 7-6)

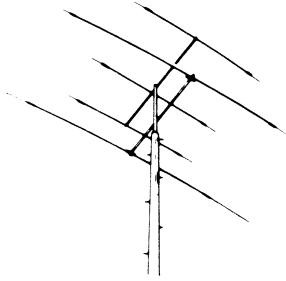

Fig. 7-6

● **Wideband Antennas**

Discone and log-periodic antennas can cover a wide frequency range. The discone antenna is omnidirectional and has a widerange from VHF to UHF. (See Fig.7-7)

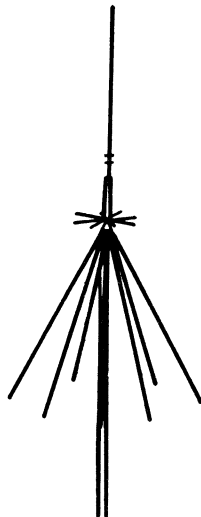

Fig. 7-7

Note:

Antennas designed for HAM BAND will generally provide satisfactory reception for SW stations near the HAM BANDS. For antenna construction details, see the ARRL ANTENNA HANDBOOK, or similar publications.

7-2-2. Grounding

Normally, the receiver will operate without being grounded. However, a good earth ground improves the efficiency of antennas such as a long-wire. It also eliminates inductive noise and protects the operator from electric shocks through the AC lines.

To ground the receiver, use a copper or brass plate (or net or rod) connected to a copper wire, and bury it in the ground about 1 ~ 7 feet (0.3 ~ 2 m) deep. A copper water pipe (not plastic) may also be used. Never use a gas pipe for grounding.

If the receiver cannot be grounded well, the conterpoise (antenna radial) would be acceptable.

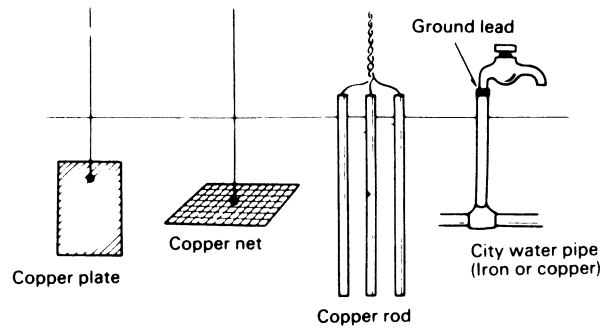

KENWOOD