



COMMUNICATIONS RECEIVER

NACHRICHTENEMPFÄNGER

RECEPTEUR DE COMMUNICATIONS

RECEPTOR DE COMUNICACIONES

Model R-600



**Downloaded by
RadioAmateur.EU**

**INSTRUCTION MANUAL
BEDIENUNGSANLEITUNG
MODE D'EMPLOI
MANUAL DE INSTRUCCIONES**

You are now the owner of an exciting product, the R-600 communications receiver. Please read this instruction manual carefully before placing your receiver in service. The unit has been carefully engineered and manufactured to rigid quality standard, and should give you satisfactory and dependable operation for many years.

AFTER UNPACKING

SHIPPING CONTAINER:

Save the box and packing in the event your unit needs to be transported for remote operation, maintenance or service.

CONTENTS

FEATURES	2
SPECIFICATIONS.....	3
SECTION 1. INSTALLATION	3
SECTION 2. CONTROLS.....	4
SECTION 3. OPERATING INSTRUCTIONS.....	5
SECTION 4. ENJOYING SW RECEPTION.....	8
OPTIONAL ACCESSORIES.....	41
BLOCK DIAGRAM.....	42
SCHEMATIC DIAGRAM.....	43
ADDITIONAL INFORMATION	46

FEATURES

1. The Model R-600 is a professional class general coverage receiver for broadcast and shortwave listening. It covers the 150 kHz through 30 MHz bands for reception of SSB, CW and AM.
2. The heart of the receiver includes a highly stabilized VFO and PLL synthesizer for trouble-free reception.
3. The circuits include band-pass filters interlocked with the band selector switch for ease of tuning.
4. The ceramic filter circuit is also interlocked with the mode switch. Selectivity matching each receive mode ks obtained at all times.
SSB/CW → 2.7 kHz AM-NARROW → 2.7 kHz
AM-WIDE → 6 kHz
5. The built-in NB (noisw blanker) circuit reduces pulsating, ignition type noises.
6. The speaker unit is placed behind the front panel for better tone quality.
7. When used in combination with a transmitter, the MUTE terminal places the R-600 in STAND-BY mode.
8. The RF attenuator provides 20 dB attenuation, making it possible to receive strong local signals without distortion.
9. The frequency display uses easy-to-read LED, which indicate true operating frequency accurate to the 1kHz order.
10. The antenna terminals can be selected according to the signal frequency or the antenna system employed.
11. A record terminal is located on the front panel. The output level is automatically controlled to the optimum level independent of the volume control position.
12. A fuse is installed in the antenna circuit to prevent damage from lightning.

CAUTION:

To protect your equipment, use a lightning arrester.

● Doublet Antenna

This type of antenna is suitable for reception of a specific band.

The relation between the overall length "L" and the tuned frequency is:

$$L \text{ (m)} = \frac{143}{\text{Freq (MHz)}} \quad L \text{ (feet)} = \frac{468}{\text{freq (MHz)}}$$

This antenna is directional. Signal strength is maximum when the antenna is at a right-angle (broadside) to the desired signal and the frequency for which the antenna is cut. It must be used with a 75-ohm coaxial feeder.

(See Fig. 1-2)

● Inverted V Antenna

This is a modified doublet antenna designed to be installed on a single pole or support. The characteristics of this antenna are almost the same as those of a doublet. The overall length "L" is a little more than that of a doublet, and is computed thus:

$$L \text{ (m)} = \frac{148}{\text{Freq (MHz)}} \quad L \text{ (feet)} = \frac{486}{\text{Freq (MHz)}}$$

(See Fig. 1-3)

● Multiband Antenna

This antenna uses more than one doublet for multiband reception. The overall length "L" is the same as that of the doublet. If the lengths L1, L2 and L3 are cut for 7 MHz, 14 MHz and 28 MHz, then L1 is tuned to 21 MHz (3 x 7 MHz), permitting reception on 4 amateur bands 7 ~ 28 MHz. When used only for reception, this antenna will cover the 6 ~ 30 MHz SW bands. (See Fig. 1-4)

● Trap Vertical Antenna

Antennas designed exclusively for BCL are available commercially, or may be built yourself. Antennas designed for HAM band (3.5 ~ 28 MHz or 7 ~ 14 MHz) operation will provide satisfactory broadcast reception for SW stations near the HAM bands. Antennas of this type are most suitable for the listener who does not have enough space for installation of a doublet or long-wire antenna. (See Fig. 1-5)

● Yagi Antenna

The Yagi antenna is best suited for reception in a specific band. This antenna features excellent directivity; it provides high gain and minimizes interference when properly installed. Yagi antennas commercially available are designed only for HAM band reception. For SW reception, it will be necessary for you to construct such antennas yourself. (See Fig. 1-6)

● Grounding

Normally, the receiver will operate without being grounded. However, a good earth ground improves the efficiency of antennas such as a long-wire. It also eliminates inductive noise and protects the operator from electric shocks through the AC lines.

To ground the receiver, use a copper or brass plate (or net or rod) connected to a copper wire, and bury it in the ground about 1 ~ 7 feet (0.3 ~ 2.0 m) deep. A copper water pipe (not plastic) may also be used. Never use a gas pipe for grounding.

If the receiver cannot be well grounded the counterpoise (antenna radial) would be acceptable.

1.5 SPEAKER

Audio output from the R-600 is 1.5 watts into 8 ohms. The R-600 has a built-in speaker. However, if an external speaker is desired (such as the KENWOOD SP-100), simply connect it to the EXT.SP jack on the rear panel. The speaker may be any good 8 ohm permanent magnet type, 4 inches or larger. The internal speaker is disconnected when an external speaker is used.

1.6 HEAD PHONES

Any low-Z (4 ~ 16 ohm) headphones may be used with the R-600. connect the headphones to the front-panel phone jack.

If a speaker is connected to the receiver, it will automatically be disconnected when the headphones are plugged into the jack.

1.7 POWER REQUIREMENTS

The R-600 operates from 100/120/220/240 V AC, 50/60 Hz. Stability is not affected within 10% of line voltage variation, due to the built-in regulated power supply. To change the voltage selector position, refer to Section 3.6.

CAUTION:

1. Operation of this receiver with a wrong power source may result in serious damage.
2. A power fuse is placed on the PLL PC board. The fuse rating should be 3A.

1.8 CONNECTION

500Ω ANT Terminal

Connect a high impedance antenna such as a long wire antenna.

50Ω Terminal

Connect a low impedance antenna.

UHF coaxial ANT connector

Use a low impedance antenna. The antenna feeder should be a coaxial cable equipped with a UHF connector.

GND Terminal

It is recommended that a short, heavy ground lead be connected to the GND terminal (rear panel) to prevent the possibility of electric shock.

SECTION 1. INSTALLATION

R-600 SPECIFICATIONS

Frequency Range.....	150 kHz-30.0MHz
Mode.....	AM, SSB, CW
Sensitivity (10 dB or more S+N/N, Antenna impedance: 50Ω)	
150 kHz – 2 MHz	
AM (NARROW, TONE:	
Center)	50μV
SSB/CW.....	5μV
2 MHz – 30 MHz	
AM (NARROW, TONE:	
Center)	5μV
SSB.....	0.5μV
Image Ratio	More than 60 dB
IF Rejection.....	More than 60 dB
Selectivity:	
AM (WIDE)	6 kHz at – 6 dB, 18 kHz at – 50 dB
AM (NARROW).....	2.7 kHz at – 6 dB, 5 kHz at – 50 dB
SSB/CW.....	2.7 kHz at – 6 dB, 5 kHz at – 50 dB
Antenna Impedance.....	50Ω/500Ω
Audio Output.....	1.5W min. (8Ω load, 10% distortion)
Audio Load	
Impedance.....	4 ~ 16Ω external speaker or headphones
Power Consumption	16W
Power Requirements.....	100, 120, 220, 240V, AC, 50/60 Hz
Semiconductors	17 ICs, 11 FETs, 40 transistors, 42 diodes, 1 display
Dimensions	W 299 mm (12-3/4 inch) H 110 mm (4-5/16 inch) D 200 mm (7-7/8 inch)
Weight	4.5 kg (9.9 lbs)

1.1 GENERAL

To obtain maximum performance from your R-600 receiver, it is recommended you read Sections 2 and 3 in their entirety before attempting to operate the unit.

1.2 ACCESSORIES

The following accessory items are included:

1. Operating manual (B50-3933-00) 1 copy
2. AC power cable (E30-1643-15) 1 piece
3. Wire for antenna 5 m
4. Miniature Speaker plug (E12-0001-05) 1 piece
5. Fuse (3A) (Power fuse) (F05-3032-05) 1 piece
Fuse (0.1A) (ANT fuse) (F05-1013-05) 1 piece

1.3 OPERATING LOCATION

As with any solid state electronic equipment, the R-600 should be kept from extremes of heat and humidity. Choose an operating location that is dry and cool, and avoid operating the receiver in direct sunlight.

1.4 ANTENNA

● Antenna and Grounding

Installation of antenna and grounding is important for optimum reception of short-wave, broadcast or amateur radio signals. A good outdoor antenna will provide the best results. The following describes various antenna types and their installation.

NOTE:

A simple method is to install the supplied wire antenna as high as possible, it must be extended to its full length for good results.

● Long Wire Antenna

This is the simplest antenna, using about 30 ~ 1000 feet (10 ~ 30m) of wire installed between poles, trees or other convenient supports. The antenna wire should be heavy 8-gauge vinyl insulated, stranded wire or 4-gauge copper wire or Copperweld. This type of antenna must be installed horizontally to a length of 60 feet (20 m) or more, and be positioned as high as possible. Note that it should be as far away as possible from AC power lines, buildings, trees and other objects.

Fig. 1-1 shows an inverted L antenna. Other antenna types such as sloping, vertical, etc. are also possible.

A long-wire antenna, when installed in an open area, is suitable for all-band operation. (See Fig. 1-1).

OUTSIDE VIEWS
AUSSENSEITE
VUE EXTERIEURE
VISTA EXTERIOR

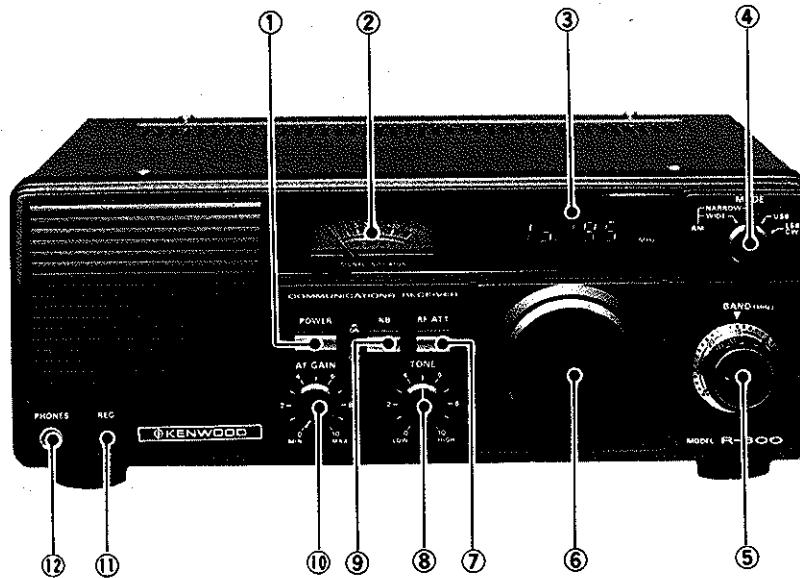

Fig. 2-1

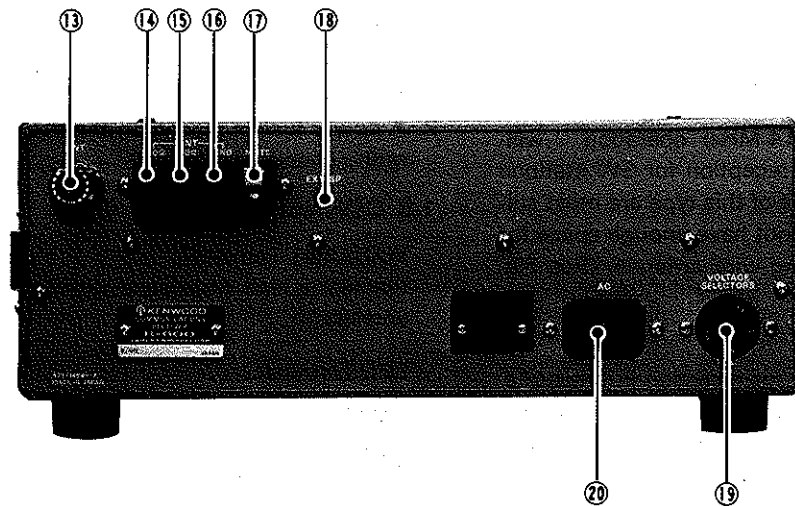

Fig. 2-2

SECTION 2. CONTROLS

[FRONT PANEL] (See Fig. 2-1)

1. POWER Switch

This switch controls power to the R-600.

2. Meter

Indicates received signal strength in S unit and SIMPO code.

3. Digital display

The digital display unit indicates operating frequency.

4. MODE Switch

AM-WIDE

With the MODE switch in this position, bandwidth is 6 kHz.

AM-NARROW

Use this position when interference is present at the AM-WIDE setting. Bandwidth is 2.7 kHz reducing interference for easier AM reception.

USB (Upper Side Band) Switch

This switch is used to receive SSB (LSB) signals.

LSB/CW (Lower Side Band/Continuous Wave) Switch

This switch is used to receive SSB (LSB) or CW signals.

5. BAND Switch

Use this switch to select the frequency band in MHz. Calibration is from 0 to 29 at 1 MHz intervals.

6. Tuning Knob

This selects the receiver's operating frequency. First select the frequency in MHz by the BAND switch, then the frequency in kHz by the tuning knob.

7. RF ATT (Attenuator) Switch

This switch allows 20 dB input signal attenuation.

8. TONE Control

This adjusts audio tone quality. Normally set at the center position.

9. NB (Noise Blanker) Switch

Turn ON to reduce pulsating, ignition-type noises.

10. AF GAIN Control

This varies the audio output. Turning clockwise will increase the volume.

11. RECORD Jack

This terminal is used for recording broadcasts on tape. Connect it to the LINE IN on your tape recorder. The output level at this terminal is constant, regardless of the R-600 (Output level: 300 mV/2 k Ω).

12. PHONES jack

This jack accepts 4 to 16 ohm impedance headphones. Stereo headphones may be used. The optional HS-6 headphone is best suited.

[REAR PANEL] (See Fig. 2-2)

13. UHF Antenna Connector

For connection of a 50 ~ 75 ohm coaxial cable with UHF connector.

14. 500 Ω ANT Connector

Connect a high impedance long-wire antenna.

15. 50 Ω Antenna Connector

For connection of a low impedance antenna.

16. GND Terminal

Ground terminal. The ground cable should be as short as possible. Select a good ground point.

17. MUTE terminal

For use in combination with a transceiver or transmitter. The R-600 will mute by grounding this terminal.

CAUTION:

The antenna input must be externally switched off when used with a transmitter or transceiver, during transmit.

18. EXT SP jack

For connection of an external speaker of 4 ~ 16 ohm impedance. The optional speaker SP-100 is best suited.

19. VOLTAGE SELECTOR

AC voltage selector switch. BEFORE operating, set this switch to your local line voltage. Consult the power company if in doubt.

20. AC Connector

Connect the supplied AC power cable.

SECTION 3. OPERATING INSTRUCTIONS

3.1 RECEPTION

Connect the unit by referring to Fig. 1-8 in Section 1. For best results, the antenna is important.

When using a low impedance antenna, connect it to 50Ω terminal. For good reception, connect the low impedance antenna through a coaxial cable to the UHF receptacle.

When using a long-wire antenna, connect it to the 500Ω ANT terminal.

Strong signals can be received clearly without the receiver being grounded.

However, a good earth ground is recommended for weak signal.

If an earth ground is not available, a counterpoise (antenna radial) would be acceptable.

1) Reading the Operating Frequency

The R-600 Digital Display accurately indicates frequency.

Refer to Fig. 3-1

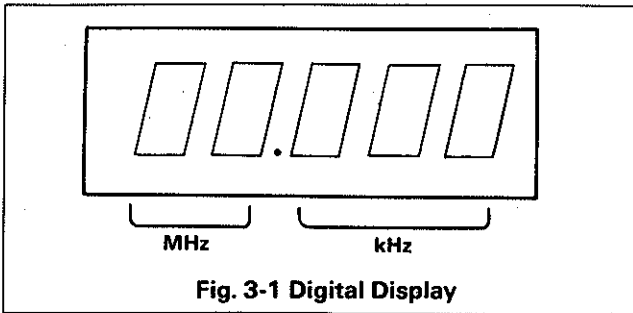

2) Setting the Frequency

The BAND switch dial is calibrated at 1 MHz intervals from 0 to 29. Fig. 3-2 shows the dial set to 9 MHz.

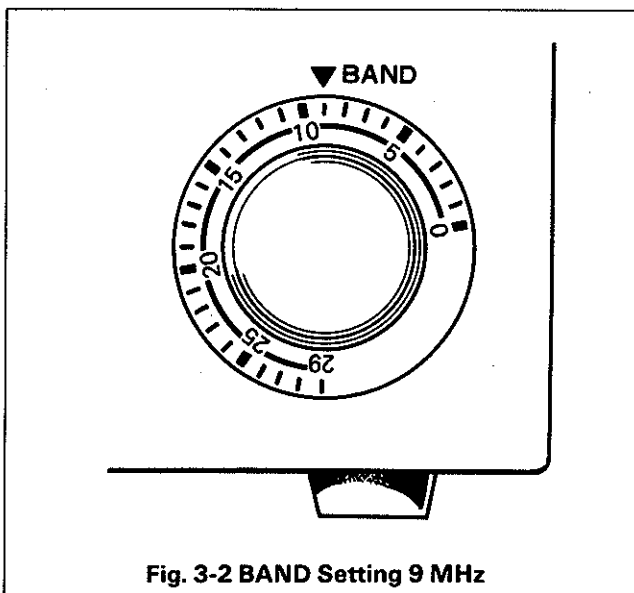

NOTE:

When receiving a signal below 150 kHz, the receiver performance might be deteriorated.

3.2 MODE SWITCH

When receiving strong local signals, set this switch to AM WIDE. This enhances reception with little interference, providing excellent tone quality.

When unwanted signals are present near the received frequency, set the switch to AM NARROW. This narrows the bandwidth, reducing radio interference.

For reception of SSB, set this switch to USB or LSB/CW according to international practice.

For reception of CW signals, set this switch to LSB/CW.

3.3 RF ATT SWITCH

If excessively strong nearby stations or high-power night broadcasts are present within the band being received, a desired signal may be blocked by receiver desensitization.

Also, if a signal is very strong, the meter may deflect off-scale. Press the RF ATT switch.

3.4 NB SWITCH

For pulse type noise, such as generated by automobile ignition systems, turn the NB switch ON. The noise will be reduced or eliminated. Power line, radar, "QRM" and atmospheric white noise will not operate the blanker.

3.5 MUTE TERMINAL

The R-600 has a mute circuit for use in combination with a transceiver or transmitter

The R-600 RF stage will mute by grounding the MUTE terminal.

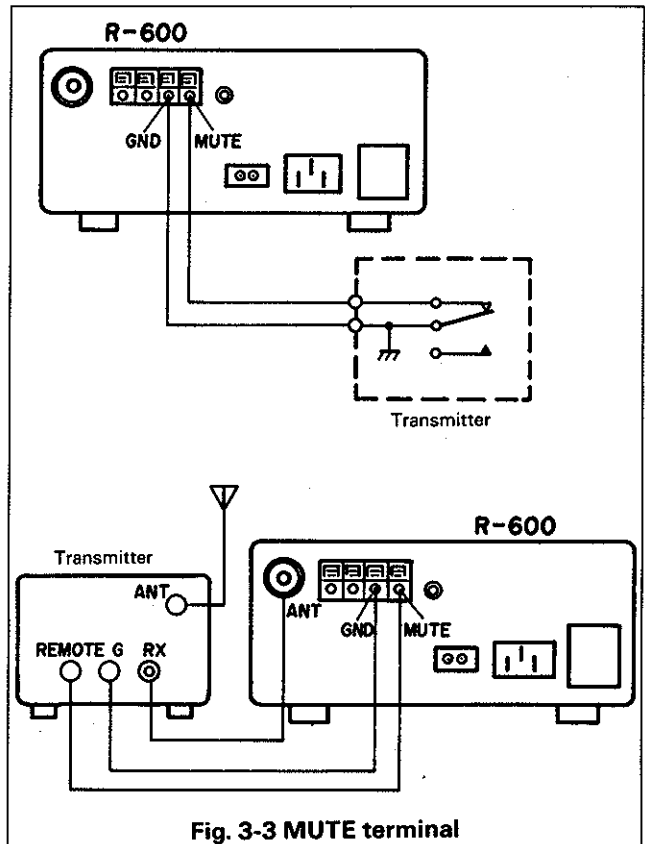

3.6 AC VOLTAGE SELECTION

The R-600 will operate on 100, 120, 220 or 240 V AC 50 or 60 Hz. For proper operation, select the power setting closest to your local line voltage.

If you are not sure of the local line voltage, contact the utility company. To reset the voltage selector, **FIRST DISCONNECT THE POWER CABLE.** Align the selector with the desired voltage using coin or screwdriver.

NOTE:

For DC operation, contact an authorized KENWOOD dealer.

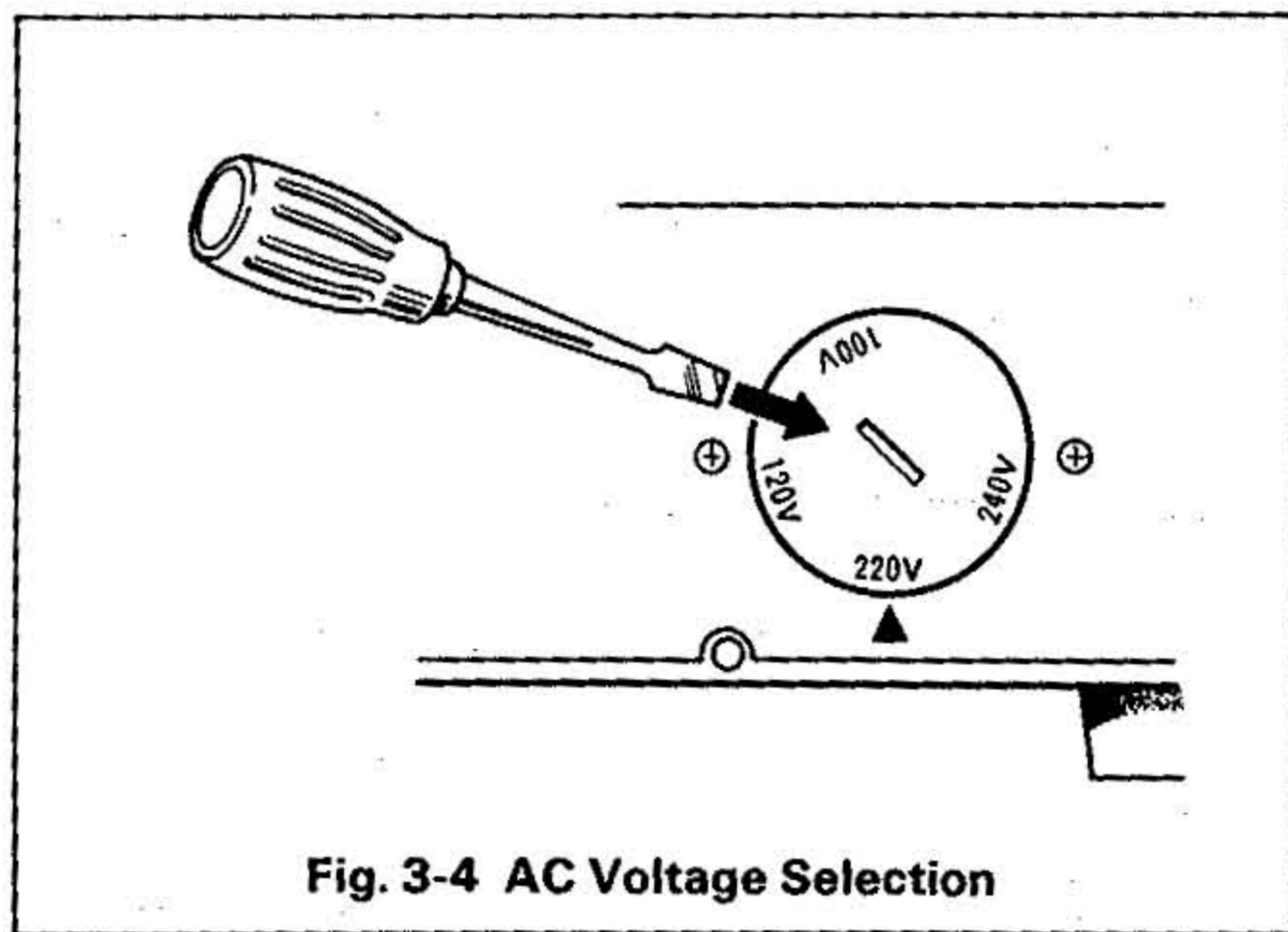

Fig. 3-4 AC Voltage Selection

3.7 FRONT FEET

The front panel can be elevated for operating convenience by extending the front feet.

Turn the front feet clockwise and pull down. Then turn it counterclockwise to lock.

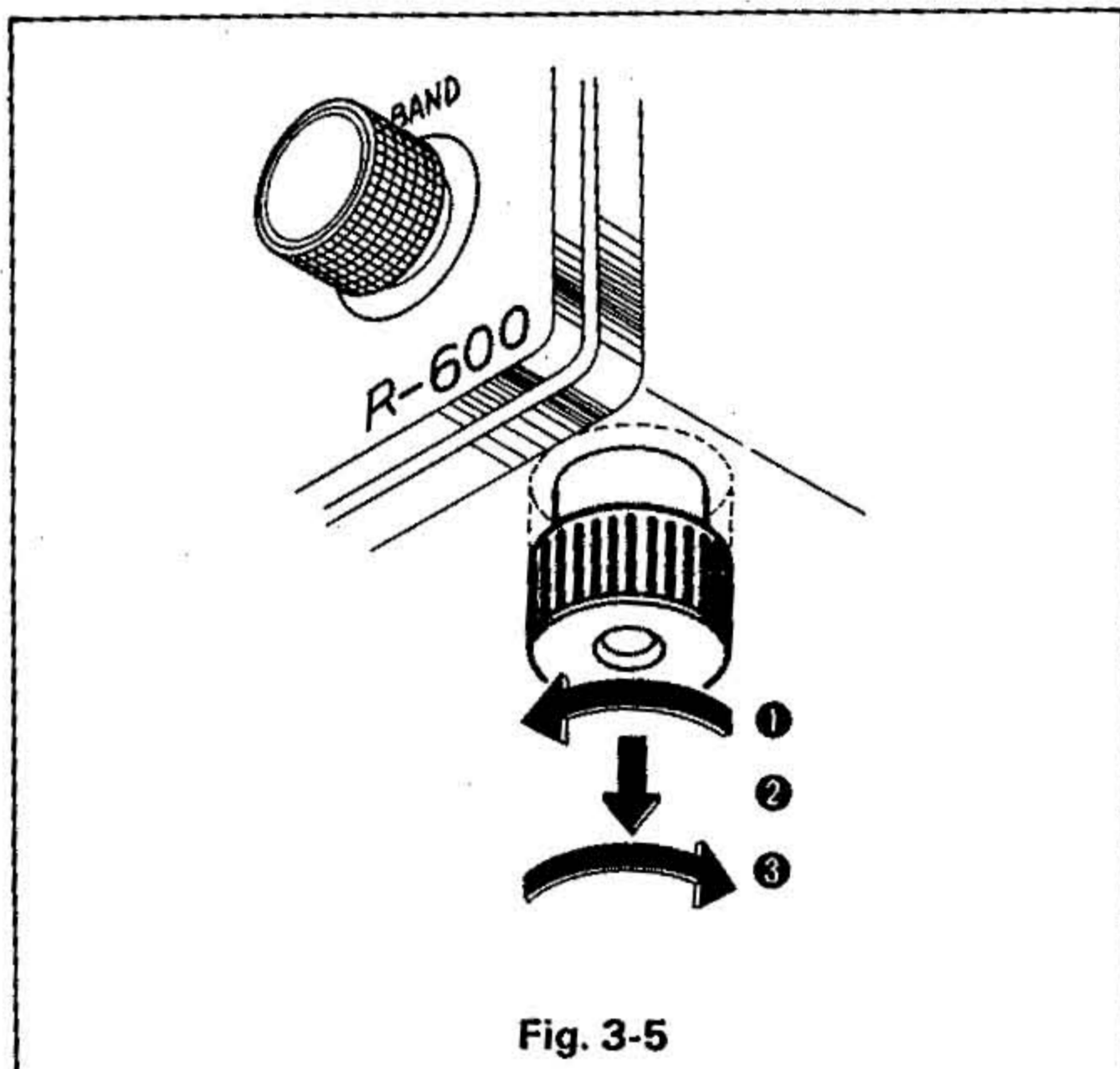
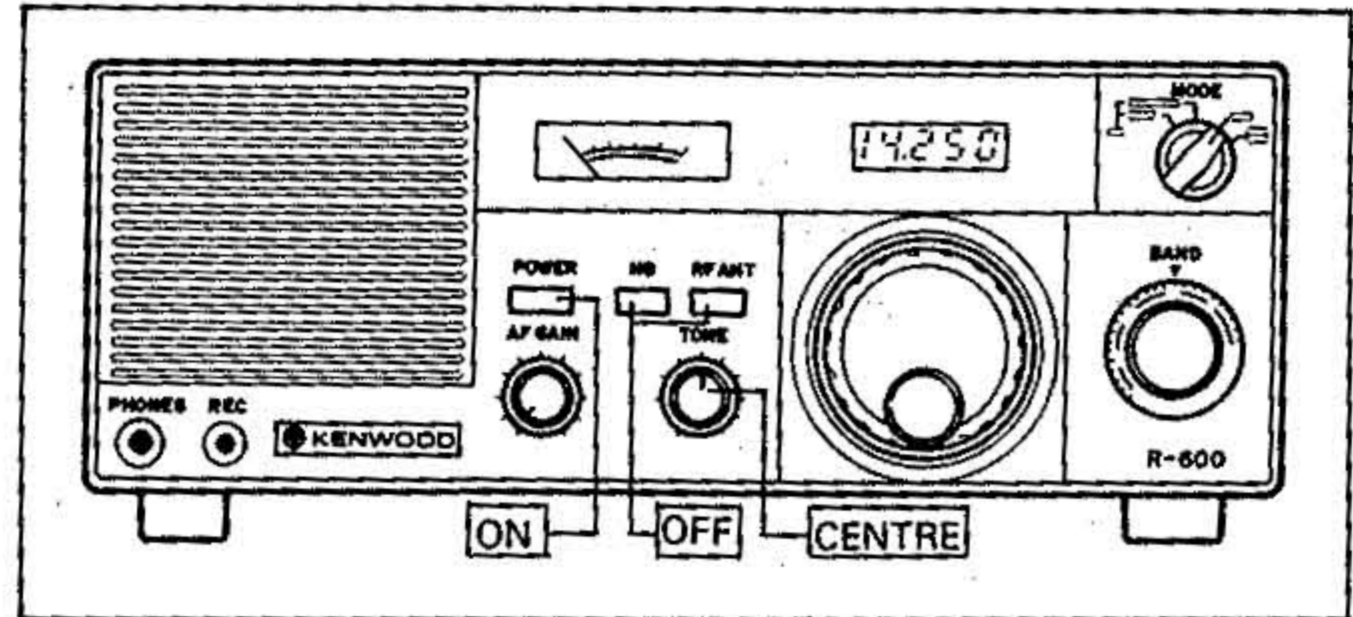

Fig. 3-5

RECEIVING AM (MW or SW) BROADCAST

● Initial Control Settings



● Operation

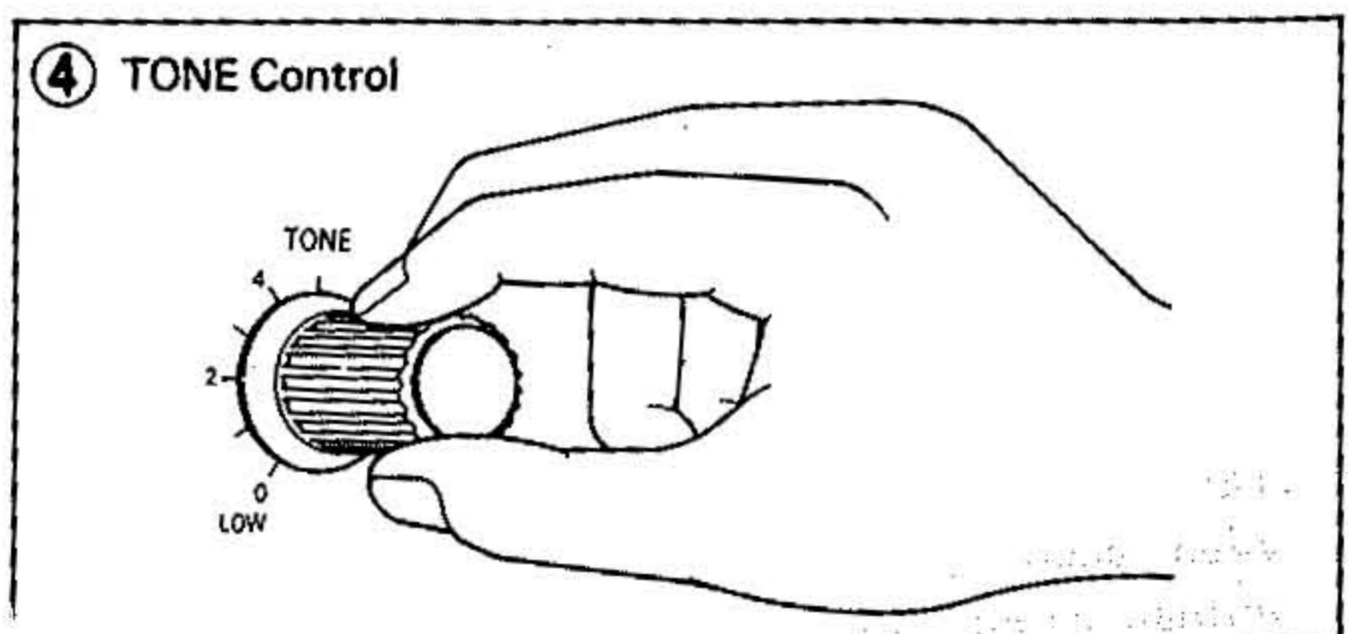
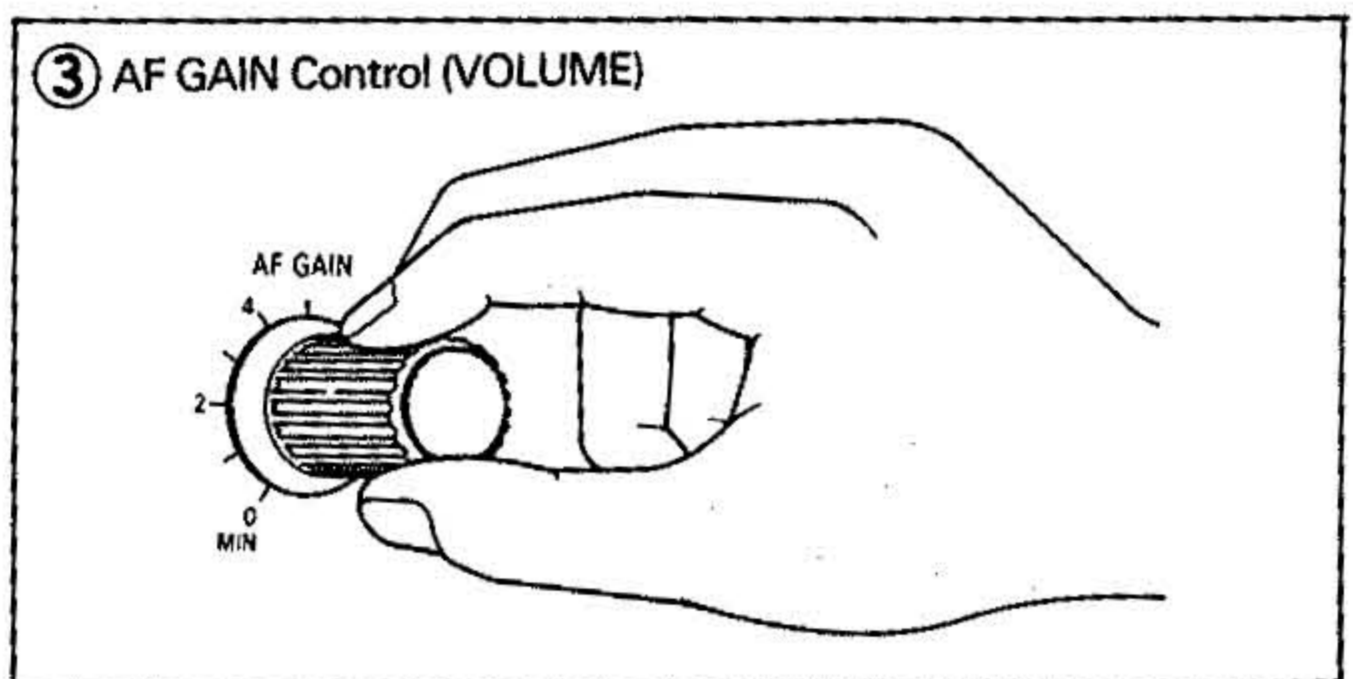
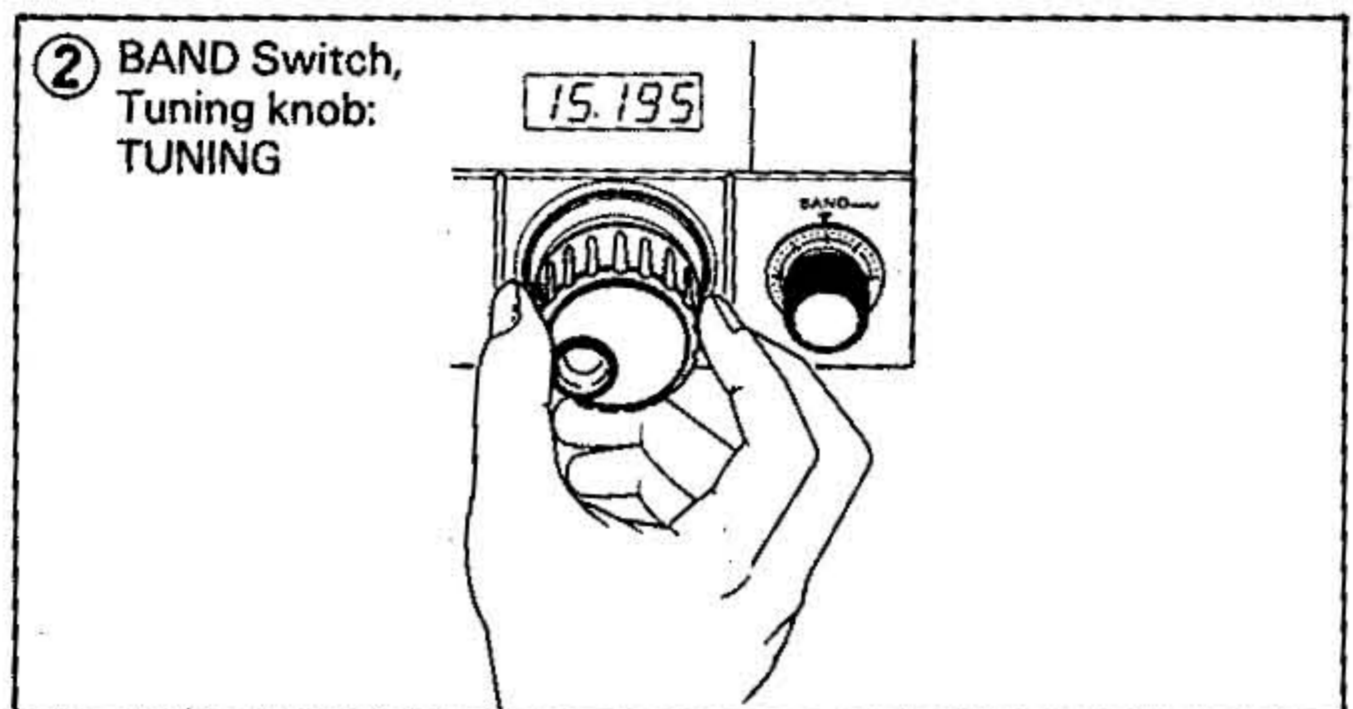
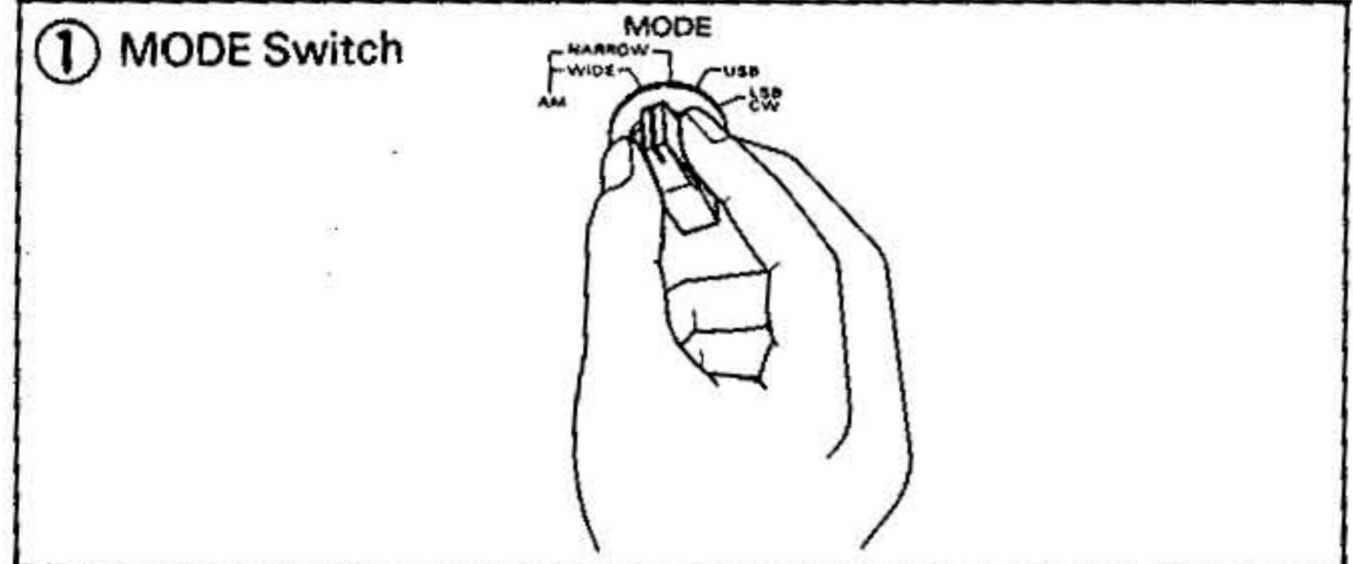

NOTE:

Radio stations throughout the world are listed in the **WORLD RADIO TV HANDBOOK** or similar publications. General radio frequency allocations are listed on page 10 of this manual.

● **For Reducing Interference**

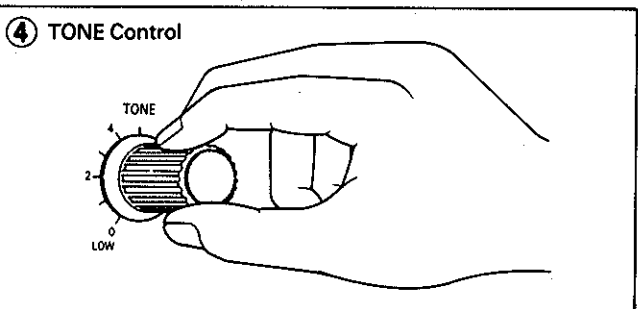
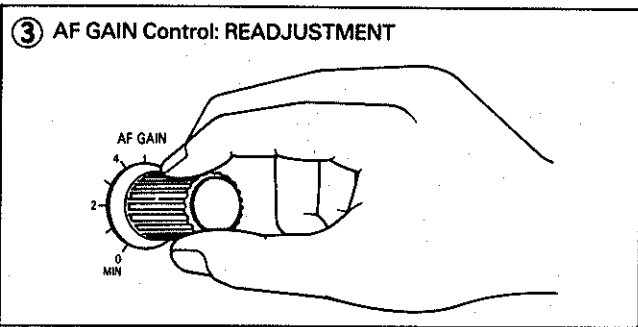
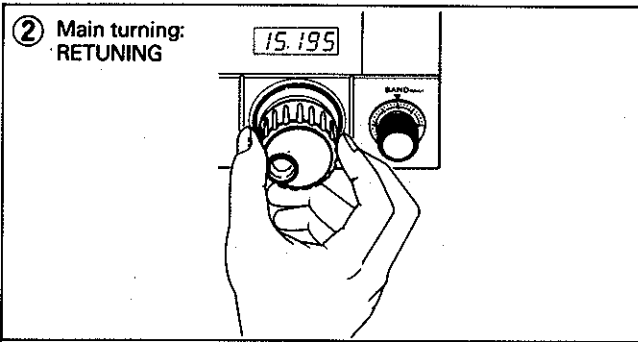
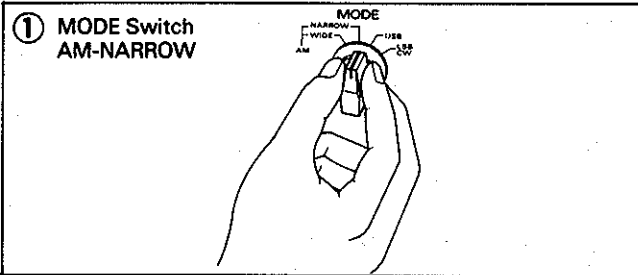

● **For Reducing Distortion Caused by Strong Signal**

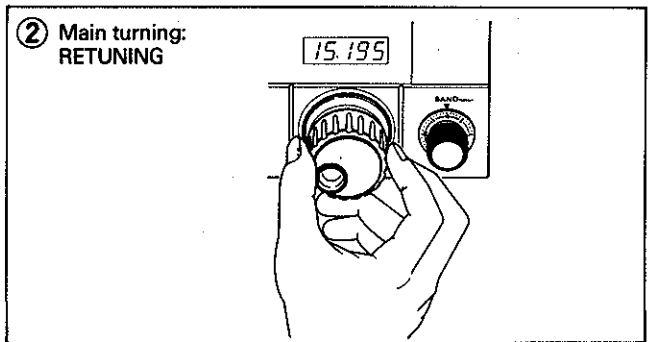
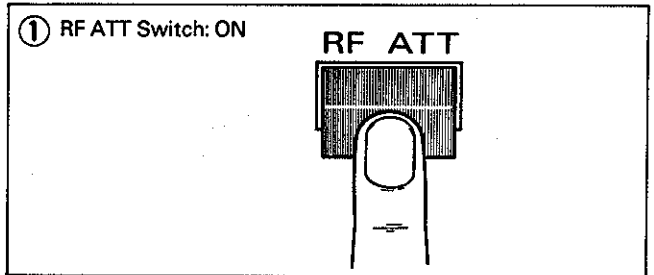

CAUTION:

At a frequency of ,000 MHz or 30,000 MHz, an inside spurious sometimes occurs.

RECEIVING SSB or CW SIGNAL

SECTION 4. ENJOYING SW RECEPTION

● Initial Control Setting

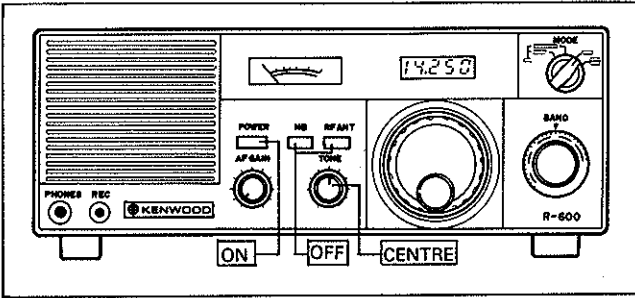

ENJOYING SW RECEPTION

Every country in the world has broadcast stations, and most countries have Amateur radio stations. The earth is virtually surrounded by innumerable radio waves, providing us with information and news. Your R-600 intercepts many of these transmissions.

Radio waves cover a wide range of frequencies including long-wave (LF), medium-wave (MF), and short-wave (SW) or high frequency (HF). Since short-wave signals travel around the earth, it is fun receiving exciting news and exotic music from overseas broadcast stations or transmissions from Amateur radio stations and various industrial, marine, government, and military. It is also interesting to collect reception or verification (QSL) cards. To ensure maximum enjoyment of short-wave reception, it is important to know the features of short-wave signals – how the signals travel around the earth, the method of receiving signals most effectively, the method of identifying the country broadcasting programs, etc.

Propagation of Radio Waves By the Ionosphere (See Fig. 4-1)

The earth is surrounded by the atmosphere. The atmospheric molecules existing between 50 km and 500 km above the earth collide with ultraviolet rays and electrons emitted from the sun, and a layer of electrons and ions is formed. This layer is called the ionosphere and it has a characteristic of refracting radio waves. Radio waves emitted from the antenna of a transmitter can be classified as surface waves and ionospheric waves. Surface waves travel along the earth directly, and are used mainly for medium frequency AM broadcast and TV and FM broadcast. Ionospheric (sky) waves travel a long distance because they are refracted repeatedly between the ionized layer and the earth. As short-wave broadcasts propagate by ionospheric waves, their signals often reach around the earth. The surface wave tends to weaken at HF and short-wave frequencies and therefore travel only a short distance, while ionospheric waves persist as the frequency increases (up to a certain point, determined by ionization intensity) and travel long distance with little path loss. Ultra high frequencies pass through the ionized layer, and thus the service area is limited to a short distance from the antenna. The ionosphere is divided into three layers, D, E and F, as shown in Fig. 4-1.

The electron density in the layer is increased in steps according to the distance from the sun. High frequency waves are refracted by the F layer and travel a long distance.

● Operation

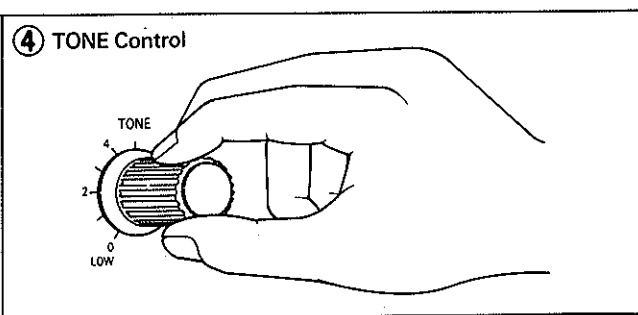
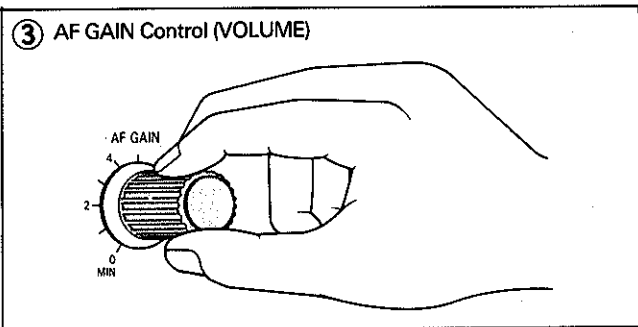
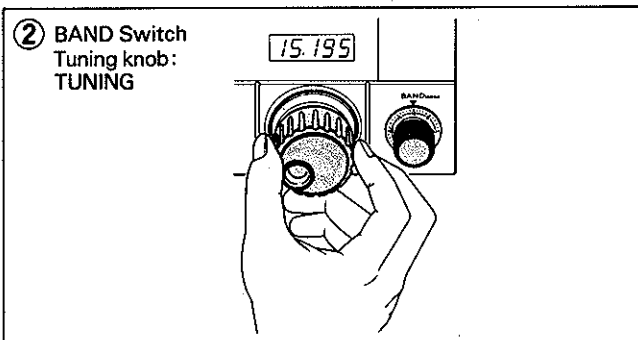
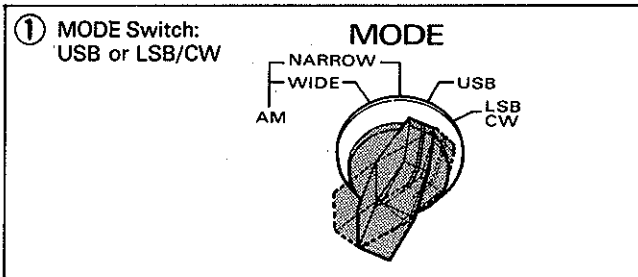

	Frequency Band	Type of Radio Wave Propagation	
		Short-distance	Long-distance
VLF	Very Low Frequency (under 30 kHz)	Surface wave	Ionospheric wave
LF	Low Frequency (30 ~ 300 kHz)	Surface wave	Ionospheric wave
MF	Medium Frequency (300 ~ 3,000 kHz)	Surface wave	Ionospheric wave
HF	High Frequency (3 ~ 30 MHz)	Ionospheric wave	Ionospheric wave

Table 1.

The state of the ionized layer is closely associated with the relative positions of the sun and the earth and also with the activity of the sun. The D and E layers almost disappear at night, while the F layer changes in height and density depending on daytime or night time, and changes the upper frequency limit to be reflected. Occasionally, "clouds" of ions will drift through the E layer, causing strong signal propagation (called "sporadic E propagation.") over several hundred miles, usually between 15 MHz and 30 MHz, and sometimes higher in frequency.

Such a phenomenon also occurs with changes in seasons or rotation cycle of the sun as well as unusual activities of the sun (change in the sunspot cycle every 11 years, unexpected explosion on the sun, etc.). To cope with this, international short-wave broadcast stations change their frequencies according to seasons or directions of radio waves, or use different frequencies at the same time for broadcasting the same program.

Frequency Distribution in the Broadcast and Amateur Bands.

The R-600 receiver covers a wide frequency range extending from 150 kHz, to 30 MHz, to receive the internationally determined frequencies assigned to many broadcast and communications services.

As shown in the Frequency Allocation Chart, Fig. 4-2, broadcast and Amateur radio station frequencies are allocated in specific bands expressed in megahertz (MHz) or wavelength in meters (m). Also in Fig. 4-2, the frequencies of "other stations" are assigned for fixed station business use, marine mobile, aviation mobile, land mobile, radio beacon stations, etc. The following relationship exists between frequency and wave length:

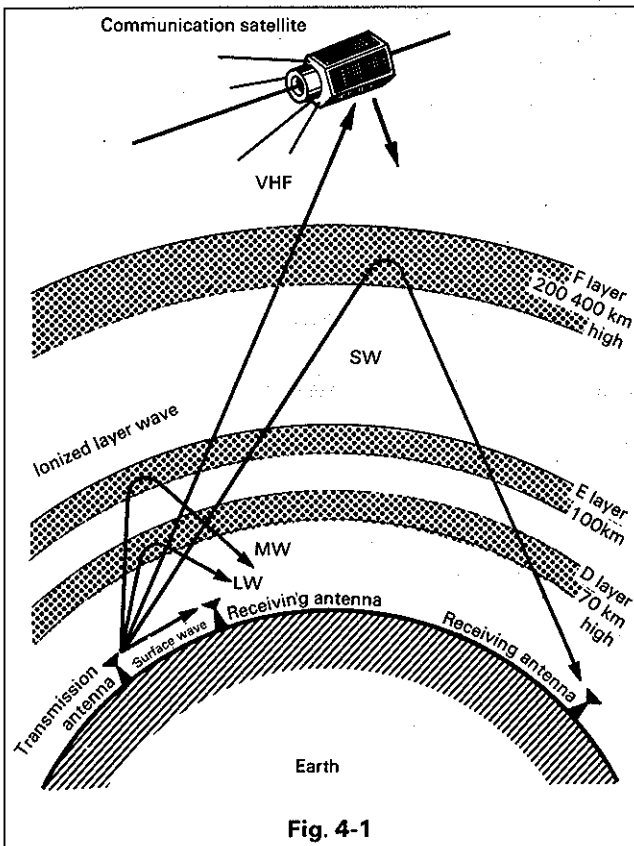
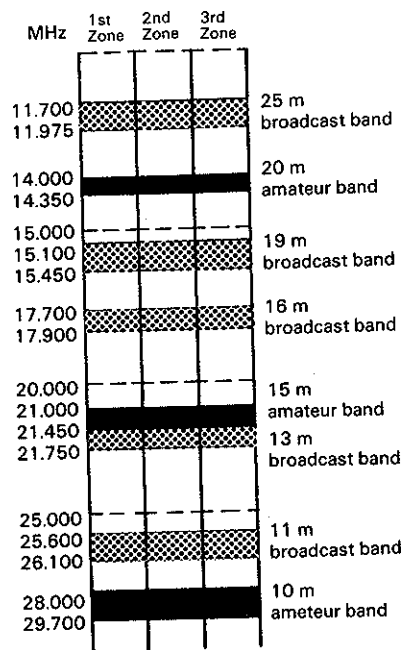
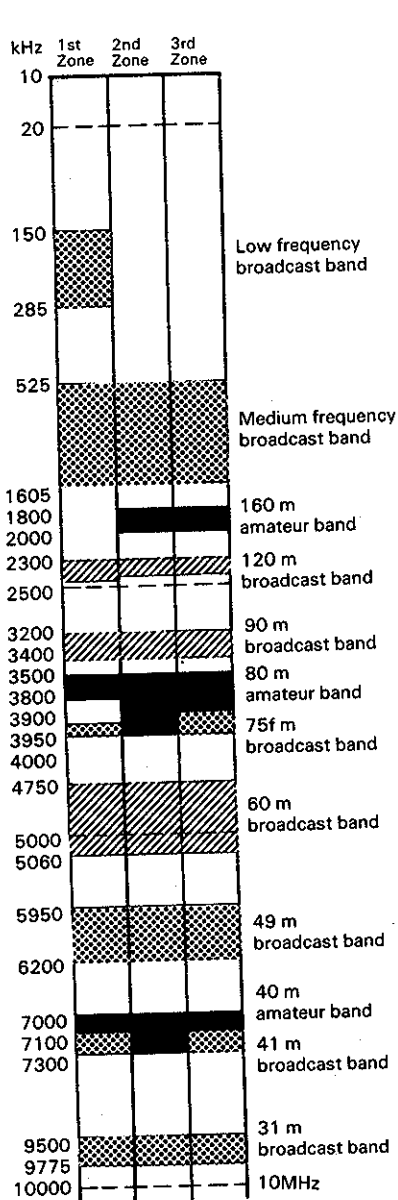

Fig. 4-1

$$\begin{aligned} \text{Wave-length (m)} &= \frac{300}{\text{Frequency (MHz)}} \\ &= \frac{300,000}{\text{Frequency (kHz)}} \\ \text{Frequency (MHz)} &= \frac{300}{\text{Wave length (m)}} \end{aligned}$$

As will be seen from this relationship, the 31 m band and 9 MHz band, for example, are the same shortwave broadcast band, covering the range of 9,500 kHz to 9,775 kHz.

RADIO FREQUENCY ALLOCATION



1st Zone: Europe and Africa (Soviet Russia, Turkey and Mongolia included)

2nd Zone: South and North America

3rd Zone: Asia and Oceania (Soviet Russia, Turkey and Mongolia excluded)

● In some countries, frequencies allocations do not accord with this table.

● Allocations of frequencies lower than 10kHz and higher than 40GHz are not internationally settled.

--- Standard wave [Cross-hatched] General broadcast band
 [Diagonal lines] Tropical broadcast band [Solid black] Amateur band
 [White box] Other stations
 (Communication frequencies included)

Fig. 4-2

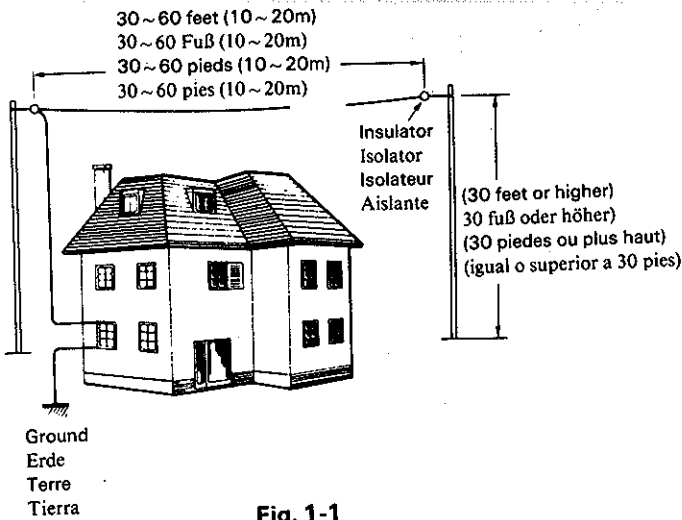

Fig. 1-1

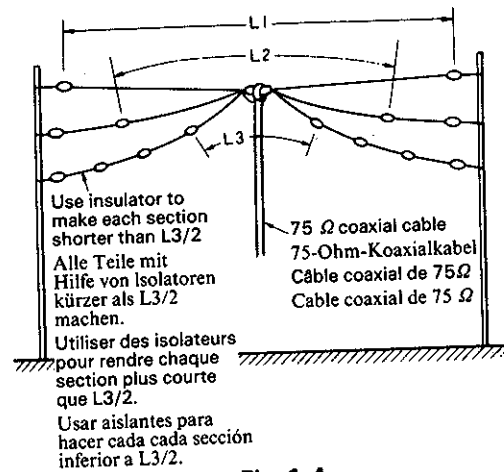

Fig. 1-4

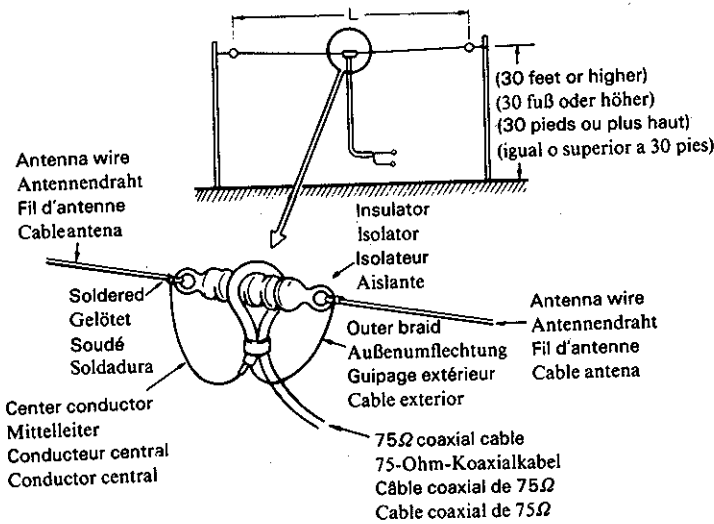

Fig. 1-2

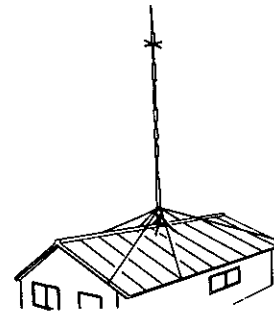

Fig. 1-5

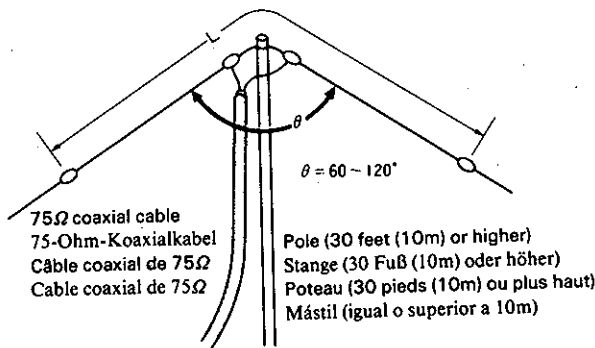

Fig. 1-3

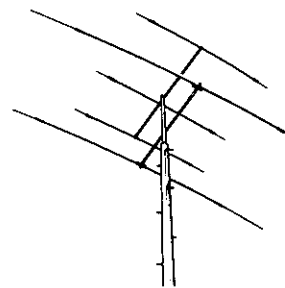

Fig. 1-6

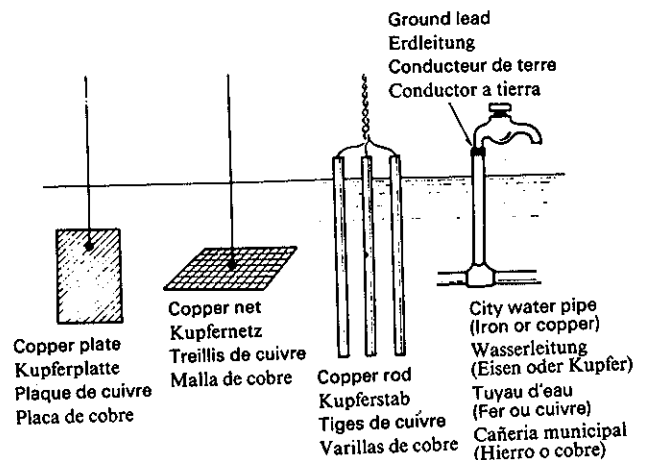

Fig. 1-7

INTERCONNECTION
ZWISCHENVERKABELUNG

INTERCONNEXION
INTERCONEXIONS

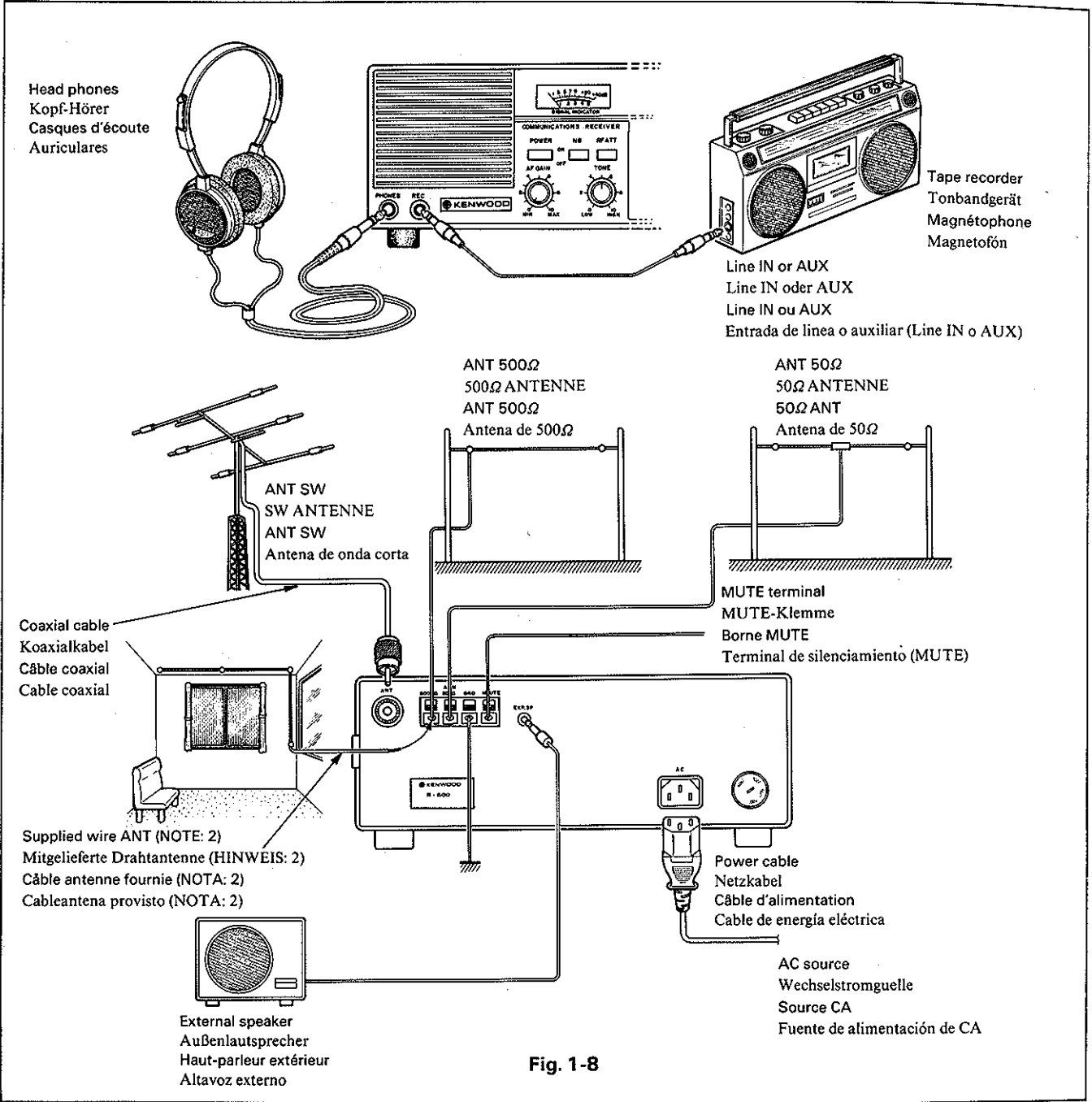

Fig. 1-8

NOTE:

1. Fig. 1-8 shows an example of R-600 interconnection. A suitable antenna should be selected (see pages 1 and 3).
2. A simpler (but less effective) antenna system is achieved by connecting the supplied wire antenna to 500Ω terminal.
3. The UHF type ANT terminal should be used for a low impedance antenna (50Ω ~ 75Ω) fed with coaxial cable.

HINWEISE:

1. Abb. 1-8 zeigt ein Beispiel der Zwischenverkabelung am R 600. Die für dieses System geeignete Antenne sollte unter Bezugnahme auf Seite 1.3 gewählt werden.
2. Für einfaches Anschließen die mitgelieferte Drahtantenne mit der 500Ω Klemme verbinden.
3. Die UHF-Typ ANT sollte für eine Antenne mit niedriger Impedanz (50Ω ~ 75Ω) benutzt werden.

NOTA:

1. La Fig 1-8 donne un exemple de l'interconnexion du R-600. En ce qui concerne le système d'antenne une antenne appropriée devrait être choisie en se référant aux pages 1, 3.
2. De manière simple connecter le fil d'antenne fourni à la borne 500Ω.
3. La borne ANT type UHF devrait être utilisée pour une antenne à faible impédance (50Ω ~ 75) avec le câble coaxial.

NOTA:

1. La Fig. 1-8 ilustra un ejemplo de las distintas interconexiones del R-600. La antena más apropiada debe seleccionarse de acuerdo con las páginas 1, 3.
2. El cableantena provisto con el aparato debe conectarse al terminal de 500Ω.
3. El terminal ANT tipo UHF debe utilizarse para una antena de baja impedancia (50Ω ~ 75Ω) conectada a través de un cable coaxial.

D.C. OPERATION KIT DCK-1 Instruction

The "DCK-1" is the D.C. power cable kit for D.C. operation of the R-1000 Kenwood Communications Receiver. Recommended D.C. voltage is 13.8V, NOMINAL.

1. Parts Supplied:

Cable with 2P connector	1 piece
D.C. cable with fuse holder (E30-1646-05)	1 piece
Spare fuse (1A) (F05-1023-05)	1 piece
Instruction sheet (B50-2703-00)	1 page
2. Mounting method
 - a. Use a #2 Phillips screwdriver to remove 6 screws and then remove the bottom cover.
 - b. Use a #1 Phillips screwdriver and a 2.6 mm nutdriver to remove the blank plate from the rear panel (See Fig. 1). The nuts and bolts will again be used in mounting the 2P connector.
 - c. Mount the 2P connector from the inside using the blank plate mounting holes. Then plug the small connector at the other end of the cable into the R-1000 power supply unit (See Fig. 2).
 - d. Position the cable alongside the other wires inside the R-1000.
3. After replacing the bottom cover, connect the R-1000 to your power supply or battery supply using the DC cable (See Fig. 3). Set the power supply voltage to 13.8V. D.C.. OBSERVE POLARITY.

NOTE:

1. About 60 mA current is consumed by the digital clock, even while the R-1000 power switch is OFF.
2. Total DC current consumption is 0.75A.

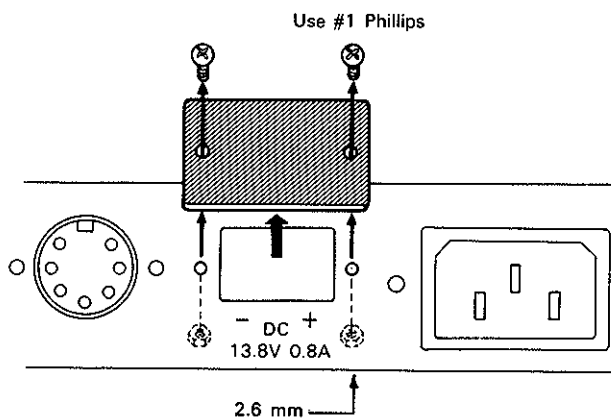

Fig. 1
Abb. 1

D.C. STROMVERSORGUNGSTEIL DCK-1 Bedienungsanleitung

Beim „DCK-1“ handelt es sich um das Gleichstromversorgungs- teil (13,8V Nennspannung) zum Betreiben des Kenwood-Nachrichtenempfängers Modell R-1000 mit Gleichstrom. Dieses Teil ist bei Anschluß an den Empfänger für Gleichstrombetrieb äußerst vorteilhaft.

1. Ersatzteilliste

Kabel mit 2-poligem Steckanschluß	1 Stück
Gleichstromkabel mit Sicherungshalter	1 Stück
Ersatzsicherung (1A)	1 Stück
Bedienungsanleitung	1 Exemplar
2. Befestigungsweise
 - a. Zunächst zwei die hinteren Füße an der Rückwand des R-1000, dann den Bodendeckel entfernen.
 - b. Die Deckplatte von der Rückwand des R-1000 entfernen (siehe Abb. 1). Die entfernten Schrauben und Muttern werden wieder beim Befestigen des 2-poligen Steckanschlusses verwendet.
 - c. Den 2-poligen Steckanschluß von innen her mit Hilfe der Deckplatten-Befestigungslöcher befestigen. Dann den kleinen Steckanschluß am anderen Kabelende in das Stromversorgungsteil des R-1000 stecken (siehe Abb. 2).
 - d. Das Kabel entlang den Drähten im R-1000 verlegen.
3. Nach Anbringen der Bodenabdeckung und der beiden Füße das R-1000 mittels des Gleichstromkabels an die Stromversorgung anschließen (siehe Abb. 3). Die Stromversorgungsspannung auf 13,8V einstellen.

HINWEIS:

Die Digitaluhr verbraucht etwa 60 mA Strom, wenn der Netzschalter des R-1000 auf Aus steht.

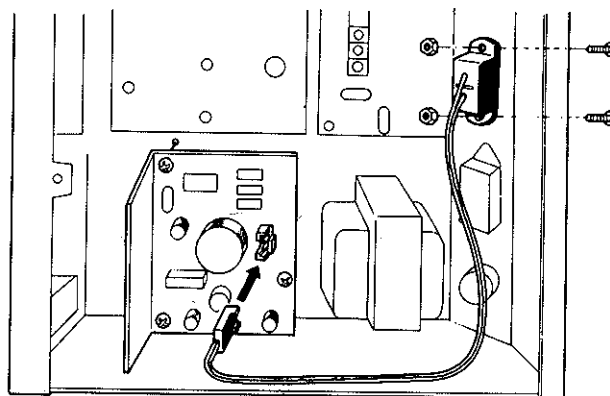

Fig. 2
Abb. 2

KIT D'ALIMENTATION CC DCK-1 Model d'emploi

Le "DCK-1" est un appareil d'alimentation de courant continu (13,8V) nominal pour utilisation en courant continu du récepteur de communications Kenwood modèle R-1000. Cet appareil branché à votre équipement vous permet de l'utiliser en courant continu.

1. Nomenclature des pièces

Câble avec connecteur à 2P	1 pièce
Câble C.C. avec porte fusible	1 pièce
Fusible de rechange (1A)	1 pièce
Mode d'emploi	1 copie
2. Méthode de montage
 - a. Retirer les deux pieds arrière du R-1000 puis retirer le couvercle inférieur.
 - b. Retirer la plaque couvercle du panneau arrière du R-1000 (voir la Fig. 1).
Les boulons et les écrous retirés seront utilisés de nouveau pour monter le connecteur à 2P.
 - c. Monter le connecteur à 2P à partir de l'intérieur en utilisant les orifices de montage de la plaque couvercle. Ensuite, enficher le petit connecteur se trouvant à l'autre extrémité du câble dans l'unité d'alimentation du R-1000 (voir la Fig. 2).
 - d. Positionner le câble le long des fils en faisceau à l'intérieur du R-1000.
3. Après avoir remis le couvercle inférieur et les deux pieds arrière en place, connecter le R-1000 avec l'alimentation à l'aide du câble CC (voir la Fig. 3). Régler la tension d'alimentation à 13,8V

N.B.:

Un courant d'environ 60 mA est consommé par la pendule numérique lorsque le commutateur d'alimentation du R-1000 est sur la position OFF.

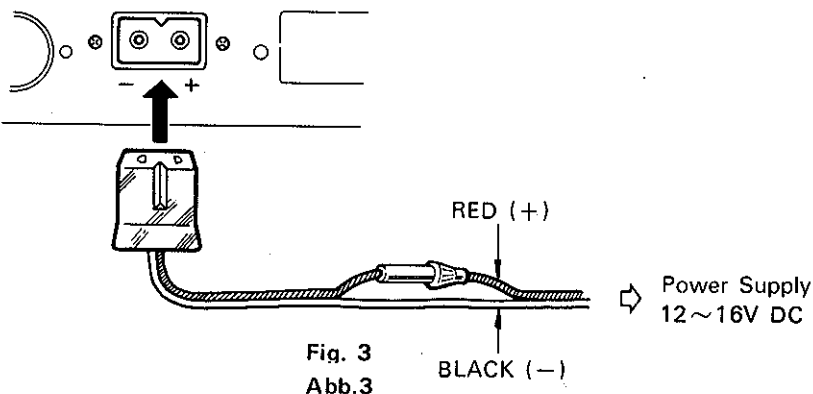

D.C. UNIDAD "DCK-1" DCK-1 Manual de instrucciones

"DCK-1" es la unidad de corriente continua (13,8V nominal) para operar el radioreceptor Kenwood modelo R-1000. Emplee esta unidad para disfrutar de operaciones con CC cuando las necesidades lo exijan.

1. Lista de piezas

Cable con enchufe de dos clavijas	1
Cable de CC con portafusible	1
Fusible de repuesto (1A)	1
Manual de instrucciones	1
2. Método de montaje
 - a. Retirar los dos apoyos localizados en el lado traseros del R-1000 y extraer la tapa del fondo.
 - b. Desmontar el panel trasero del de tapa R-1000 (ver Fig. 1).
Las tuercas y tornillos se volverán a utilizar para instalar el enchufe de dos clavijas.
 - c. Instale el enchufe 2P desde el interior usando los agujeros provistos para tal fin en el panel trasero de tapa. Luego, conecte el pequeño enchufe en el otro extremo del cable a la unidad de CC (ver Fig. 2).
 - d. Coloque el cable a lo largo de los alambres cables en el interior del R-1000.
3. Luego de volver a colocar la tapa del fondo y los dos apoyos en su lugar, conectar el R-1000 y la unidad de CC usando el cable de CC (ver Fig. 3). Colocar el voltaje de alimentación en 13,8V.

NOTA:

El reloj digital consume una corriente de aproximadamente 60 mA cuando el interruptor del R-1000 está en la posición OFF.

**Downloaded by
RadioAmateur.EU**

A product of
TRIO-KENWOOD CORPORATION
17-5, 2-chome, Shibuya, Shibuya-ku, Tokyo 150, Japan

TRIO-KENWOOD COMMUNICATIONS, INC.
1111, West Walnut Street, Compton, California, 90220, U.S.A.
TRIO-KENWOOD COMMUNICATIONS, GmbH
D-6374 Steinbach TS, Industriestrasse 8A, West Germany
TRIO-KENWOOD (AUSTRALIA) PTY. LTD.
30 Whiting Street, Artarmon, Sydney N.S.W. Australia 2064