

KENWOOD

144/430MHz FM DUAL BANDER
144/440MHz FM DUAL BANDER

TH-77A

144/430MHz FM DUAL BANDER

TH-77E

INSTRUCTION MANUAL

KENWOOD CORPORATION

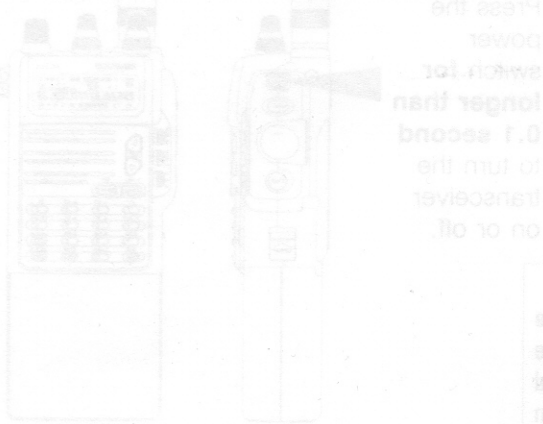

FCC WARNING
This equipment may generate or use radio frequency energy. Changes or modifications to this equipment may cause harmful interference unless the modifications are expressly approved in the instruction manual. The user could lose the authority to operate this equipment if an unauthorized change or modification is made.

CAUTION
During fixed station operation, the supplied antenna may cause interference to nearby electronic equipment. It can also increase the supply voltage from an external D.C. power supply. To avoid these conditions, a low gain external antenna can be used. A gain type antenna can lead to intermodulation distortion.

FCC WARNING

This equipment may generate or use radio frequency energy. Changes or modifications to this equipment may cause harmful interference unless the modifications are expressly approved in the instruction manual. The user could lose the authority to operate this equipment if an unauthorized change or modification is made.

CAUTION

During fixed station operation, the supplied antenna may cause interference to nearby electronic equipment. It can also increase the supply voltage from an external D.C. power supply. To avoid these conditions, a low gain external antenna can be used. A gain type antenna can lead to intermodulation distortion.

Press the power switch **for longer than 0.1 second** to turn the transceiver on or off.

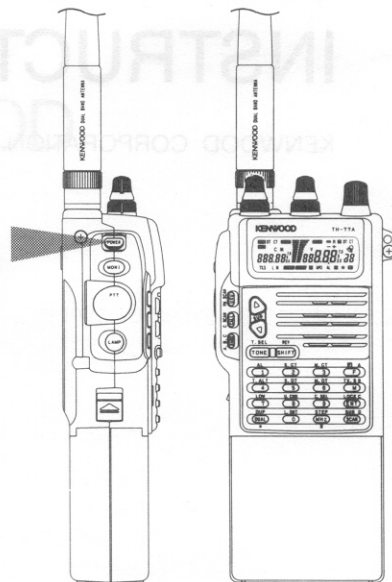

CONTENTS

1.	BEFORE OPERATION	4
2.	SPECIFICATIONS and ACCESSORIES	4
3.	BATTERY PACK	6
4.	OPERATION	8
4-1	OPERATING CONTROLS	8
4-2	RECEIVER OPERATION	17
	Receiver Operation	
	Frequency Selection	
	Frequency Step Selection	
	Programmable VFO Tuning Limits	
	A.B.C.(Automatic Band Change)	
	U×U(430MHz Band Simultaneous Reception)	
4-3	TRANSMITTER OPERATION	21
4-4	MEMORY	23
	Microprocessor Memory Back-up	
	Microprocessor Initialization Memory	
	Channel Memory Contents Memory Entry	
	Memory Channel Recall Memory Shift	
	Memory Recall when the Keyboard Cover is Installed	
4-5	SCAN	29
	Scan Options Hold/Resume Programming	
	Band Scan Programmable Band Scan MHz	
	Scan Memory Channel Scan VFO/Memory	
	Channel Scan Call Scan	
	V/M/C (VFO/ Memory /Call) Scan Memory	
	Channel Lockout Priority Alert Function	

4-6	REPEATER OPERATION	34
	Transmitter Offsets Reverse Function Tone and CTCSS Operation Autopatch Operations	
4-7	DTMF MEMORY FUNCTION	37
4-8	DTSS	
	DTSS Code DTSS Code Selection Using the DTSS Function Using DTSS with a Repeater	
4-9	PAGING	41
	Paging Code Memories Setting the Paging Code Paging Transmission (Calling) Paging Reception (Wait) Code LockOut	
4-10	TONE ALERT SYSTEM	47
4-11	BATTERY SAVER	48
4-12	AUTOMATIC POWER OFF	48
5.	BLOCK DIAGRAM and SCHEMATIC DIAGRAM	
	another sheet	
6.	MAINTENANCE	49
	In Case of Difficulty	
7.	OPTIONAL ACCESSORIES	51

1. BEFORE OPERATION

Thank you for purchasing this new transceiver.

IMPORTANT

Please read this instruction manual carefully before placing your transceiver in service.

CAUTION

Long transmission or extended operation in the HI power mode might cause the rear of this transceiver to get warm. Do not place the transceiver where the heat sink (rear panel) might come in contact with plastic or vinyl surfaces.

SAVE THIS INSTRUCTION MANUAL.

This Instruction Manual covers the following models:

- TH-77A : 144 / 440 MHz FM DUAL BANDER with CTCSS unit. (U.S.A.and Canadian version)
- TH-77A : 144/430 MHz FM DUAL BANDER.
(Other market)
- TH-77E: 144/430MHz FM DUAL BANDER.
(U.K.and European version)

The following explicit definitions apply in this manual:

NOTE If disregarded, inconvenience only, no risk of equipment damage or personal injury.

CAUTION Equipment damage may occur, but not personal injury.

2. SPECIFICATIONS and ACCESSORIES

2-1. SPECIFICATIONS

GENERAL		144MHz band	440/430MHz band
FREQUENCY RANGE (MHz)	U.S.A. Version	144 to 148	438 to 450
	U.K.and Europe	144 to 146	430 to 440
	Other market	144 to 148	430 to 440 or 438 to 450
MODE		F3E (FM)	
ANTENNA IMPEDANCE		50 Ω	
OPERATING TEMPERATURE		-20°C ~ +60°C (-4°F~140°F)	
POWER REQUIREMENTS	DC IN (nominal)	7.2 V ~ 16 VDC (13.8 VDC)	
	BATTERY PACK	6.3 V ~ 16 VDC (7.2VDC)	
CURRENT DRAIN			
13.8VDC (Ext.Power Supply)		H	Approx. 1.5A
7.2VDC (Battery)		H	Approx. 1A
Transmit mode		L	Approx. 0.5A
SIMPLEX			
Receive mode with no signal			Approx. 60mA
SIMPLEX Battery Save mode			Approx. 65mA
DUPLEX			
Receive mode with no signal			Approx. 18mA
DUPLEX Battery Save mode			Approx. 20mA
Receive mode with no signal			Approx. 120mA
DUPLEX Battery Save mode			Approx. 120mA
DUPLEX Battery Save mode			Approx. 30mA
DUPLEX Battery Save mode			Approx. 30mA
GROUND		Negative	
DIMENSION (W × H × D)		58 × 140.5 × 29.5 mm	

DIMENSION (Projection Included)		68.5 × 154.5 × 39mm	
WEIGHT		427g	
MICROPHONE IMPEDANCE		2kΩ	
TRANSMITTER			
OUTPUT POWER	H (13.8VDC)	more than 5W	
	H (7.2VDC)	Approx. 2W	Approx. 1.5W
	L	Approx. 0.5W	
MODULATION		Reactance	
MAXIMUM FREQUENCY DEVIATION		± 5kHz	
SPURIOUS RADIATION		less than - 60dB	
RECEIVER			
CIRCUITRY		double conversion super-heterodyne	
INTERMEDIATE FREQUENCY 1 ST IF	45.05MHz	58.525MHz	
INTERMEDIATE FREQUENCY 2 ND IF	455 kHz		
SENSITIVITY (12dB SINAD)	less than - 16dBμ (0.16μV)	U × U MODE ;	less than - 15dBμ (0.18μV)
	less than - 11dBμ (0.28μV)		
SQUELCH SENSITIVITY	less than - 20dBμ(0.1μV)		
SELECTIVITY - 6dB	more than 12kHz		
SELECTIVITY - 60dB	less than 24kHz		
AUDIO OUTPUT POWER (10% distortion)	More than 200 mW (across 8Ω load)		

- NOTES: 1. Circuit and ratings are subject to change without notice, due to development in technology.
 2. Recommended duty cycle : 1 minute Transmission, 3 minutes Reception

2-2. ACCESSORIES

Unpack your new transceiver carefully and examine it for visible damage. If the equipment has been damaged in shipment, notify the transportation company immediately. Save the boxes and packing material for future shipping. The following accessories should have been included in the box with the transceiver:

Antenna	T90-0414-XX	..	1
Belt Hook	J29-0424-XX	..	1
Hand strap	J69-0312-XX	..	1
Keyboard Cover	F07-1202-XX	..	1
Bottom Cover	F07-0896-XX	..	1
NiCd Battery pack			1
(PB-6) for U.S.A. and Canada		W09-0507-XX		
(PB-10) for other market	W09-0535-XX		
Battery charger			1
(BC-9)				
for U.S.A. (120V)	W09-0382-XX		
for Canada (120V)	W09-0385-XX		
(BC-2)				
for Europe (220V)	W09-0317-XX		
for U.K. (240V)	W09-0318-XX		
for Oceania (240V)	W09-0527-XX		
(BC-12)				
for other market (120/240V)	..	W09-0534-XX		
AC plug (M type only)	E19-0254-XX	..	1
Instruction Manual	B62-0007-XX	..	1
Warranty Card (U.S.A., Canada, and Europe)	..			1

3. BATTERY PACK

■ Ni-Cd BATTERY PACK(PB-10)

This battery pack has not been charged at the factory in order to provide you with the greatest number of charge / discharge cycles. You must charge the battery before use. The battery pack will require several charge / discharge cycles before you can expect to see the maximum operating period between charges. If the battery will be stored for longer than 2 months it should be recharged before use.

■ RECHARGING

CAUTION (for general market only)

The BC-12 has a voltage selection switch (120V / 230V). Make certain that the switch setting matches the AC line voltage.

1. Interconnect the adapter to the NiCd battery pack.
2. Plug the battery charger into an AC outlet.
3. Do not allow the battery to charge for greater than 15 hours. The useful life and battery performance will be reduced if you exceed the recommended charge period.

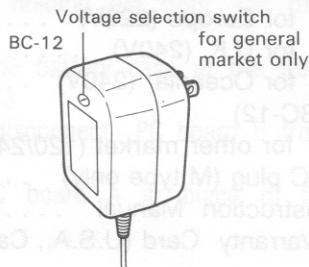
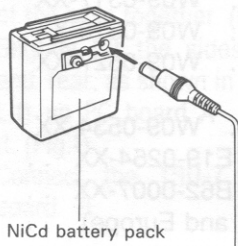

NOTE

Recharging should be done within an ambient temperature between 5°C ~ 40°C (41°F ~ 104°F). Recharging performed out of this range may not fully charge the battery.

■ MANGANESE or ALKALINE BATTERIES(BT-6)

Load 6 × R6 (AA) manganese or alkaline batteries in series in the optional battery case(BT-6). (Be sure to observe the polarities.) We recommend the use of high performance manganese batteries.

Press down on the hook in the middle of the battery case top to open.

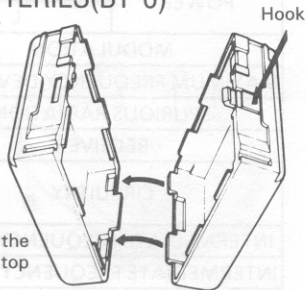

CAUTION

Do not install NiCd batteries and attempt to charge them with the supplied charger. There is no battery protection circuit in the battery holder.

■ INSTALLING THE BATTERY PACK

Align the grooves in the battery pack with the transceiver and slide the pack to the right until it locks in place.

To remove the battery pack push up on the RELEASE button and slide the pack to the left.

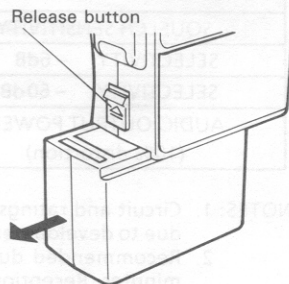

■ BATTERY VOLTAGE LEVEL METER

The meter indicates the relative battery voltage during transmit.

Recharge or replace the batteries when the level reaches the low indicator.

NiCd Battery pack

Model	V	mAh	Fully charged	Fully discharged
PB-5	7.2	200		
PB-6		600		
PB-9				
PB-7		1100		
PB-8	12	600		

Manganese or Alkaline batteries (Approximate battery condition)

New batteries	Need to change batteries

■ OPERATING TIME

[Hour]

	144MHz			430MHz		
	H	M	L	H	M	L
Alkaline Battery	2	2	4	2	2.5	4
Manganese Battery	—	—	0.8	—	—	0.8
PB-5	0.5	0.5	1.0	0.5	0.5	1.0
PB-8	1.2	1.5	3.0	1.1	1.4	3.0
PB-6,9,10	1.5	1.5	3.0	1.5	1.5	3.0
PB-7	2.7	2.7	5.0	2.7	2.7	5.0

- 1 minute Transmission, 3 minutes Reception, AF output 0.2W/8Ω.
- Battery Saver function on. Simplex operation mode.

CAUTION

When the battery is overdischarged, the indicator begins flashing and the POWER switch may not function. Immediately charge or replace the battery.

We recommend use of the NiCd battery pack for long transmission or extended operation.

Manganese batteries (except Alkaline manganese batteries) is available for Low position.

4. OPERATION

4-1. OPERATING CONTROLS

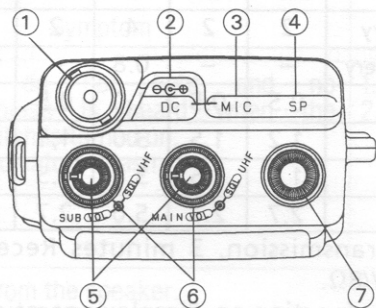

① Antenna connector

Connect the antenna that is supplied to this connector. Twist to lock.

② DC IN terminal

This terminal is used for an external power supply. Input voltage is 13.8 VDC nominal. The center is the + side and the sleeve is the - side.

NOTE

You should turn the power switch OFF when connecting a power source to this terminal. Pay close attention to polarity.

Use the KENWOOD PG-2W or PG-3F optional cable for connection.

③ MIC jack

This jack is used for connection of an external microphone. The use of an electret type microphone is recommended. Input impedance is 2k Ω and the DC voltage on this terminal is Approx. 4 V (MAX 3.5 mA).

The use of a dynamic microphone is not recommended.

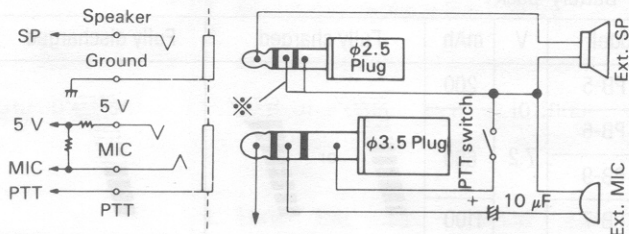

※ Always ensure that this connection is made.

④ SP jack

This jack is used to connect an stereophonic external speaker or earphone. The recommended impedance is 8 Ω .

If you hold and press the DUAL key while you turn the POWER switch to on, the radio will exchange 1 and 2 below.

1. Audio signals from both bands will be heard only from the external speaker (initial setting).
2. Audio from TX band will be heard from the internal speaker, and audio from RX band will be heard from the external speaker.

(If you hold and press the BAND key while you turn the POWER switch to on, the band will exchange each other.)

⑤VOL controls

Rotating the control further clockwise will increase the volume.

⑥SQL(Squelch) controls

These controls are used to select the desired Squelch threshold level.

⑦Tuning control

This control is used to select the desired transmitter / receiver frequency, MHz step, Memory Channel, Frequency Step, Tone Frequency, Scan Direction, etc.

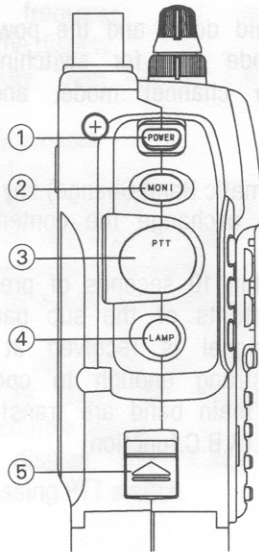

①POWER switch

Press for longer than 0.1 second to turn the transceiver ON or OFF.

②MONI switch

Pressing this switch will disable the squelch function as long as the switch is held depressed.

When operating in the CTCSS (Tone Squelch) mode you can use this switch to determine if the frequency is in use before transmitting. Pressing this switch will disable the CTCSS function as long as the switch is held depressed.

After you press and hold this switch while you turn on the POWER switch, rotating the Tuning control will select monitoring band.

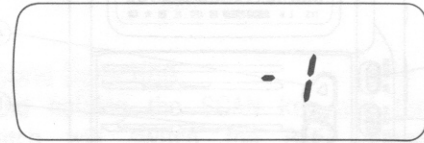

- 1. Both main and sub band can be monitored.
- 2. Main band only can be monitored.
- 3. Sub band only can be monitored.

③PTT (Push To Talk) switch

Press this switch whenever you wish to transmit.

④ LAMP key

This switch is used to control the night lamp on the LCD display. The lamp will turn itself OFF automatically 5 seconds after the last key operation.

Pressing the key within 10 seconds of pressing the F key will light the lamp on the LCD display permanently until pressing this key again.

⑤ RELEASE button

Press this button upward to release the battery pack.

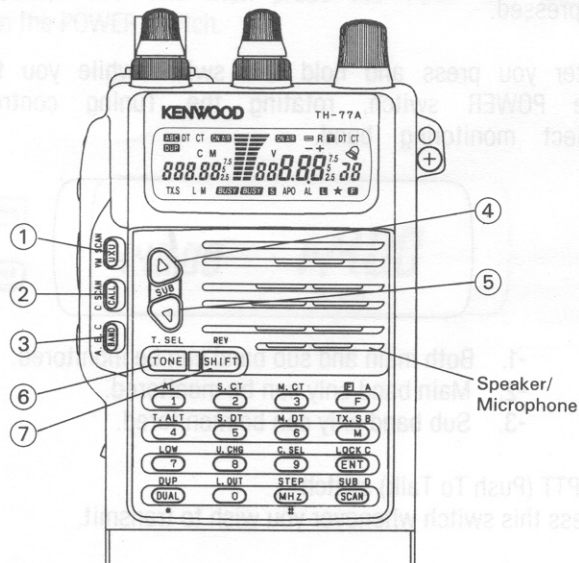

① U×U / VM SCAN key

This switch is used to select dual UHF watch operation. In dual watch operation the V indicator will light on the previous VHF band display.

Pressing the key within 10 seconds of pressing the F key will initiate VFO and last memory channel scan.

② CALL/C SCAN key

Press this key to activate the call channel function.

Pressing the key within 10 seconds of pressing the F key will initiate CALL CHANNEL SCAN.

(Mode key)

When this key is held down and the power switched on, it becomes the Mode key for switching between the VFO mode, Memory channel mode, and Call channel mode.

③ BAND / A.B.C.(Automatic Band Change) key

This key is used to exchange the contents of the main band and sub band.

Pressing the key within 10 seconds of pressing the F key will transfer the contents of the sub band to the main band whenever a signal is received at the sub band antenna, which is strong enough to open the squelch. The contents of the main band are transferred to the sub band at the same time.(A.B.C.function)

④SUB UP key

This key is used to increment the SUB band receive frequency or memory channel.

Pressing the key within 10 seconds of pressing the F key will recall the UPPER LIMIT frequency of the programmable band scan.

⑤SUB DOWN key

This key is used to decrement the SUB band receive frequency or memory channel.

Pressing the key within 10 seconds of pressing the F key will recall the LOWER LIMIT frequency of the programmable band scan.

⑥TONE / T.SEL key

Except European version: This key is used to activate the subaudible tone encoder.

European version only: This key is used to transmit the 1750 Hz repeater access tone whenever this key is depressed.

(U.S.A., Canadian version ,or with optional TSU-7) Pressing the key within 10 seconds of pressing the F key will switch to the tone frequency selection mode. The Tuning control can then be used to select the desired tone frequency.

⑦SHIFT/ REV key

This key is used to select the desired transmitter offset direction. Pressing the key will cause the radio to shift from one offset direction to the other, i.e. + to - to

simplex where no indicator shows. [- to - - for European version (UHF band)].

Pressing the key within 10 seconds of pressing the F key will reverse the transmit / receive frequencies during repeater operations. If you have selected simplex this key will not function.

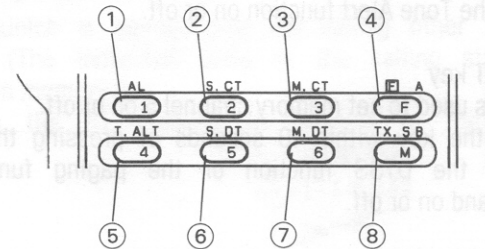

①1/AL key

This key is used to set memory channel 1 on or off.

Pressing the key within 10 seconds of pressing the F key will check Memory Channel 1 at approx. 5 second intervals. If the channel is busy, a beep will sound.

②2/ S.CT key

This key is used to set memory channel 2 on or off.

Pressing the key within 10 seconds of pressing the F key will turn the CTCSS function of the sub band on or off.

③3 / M.CT key

This key is used to set memory channel 3 on or off.

Pressing the key within 10 seconds of pressing the F key will turn the CTCSS function of the main band on or off.

④F key

This key is used to activate control of the functions.

⑤4 / T.ALT key

This key is used to set memory channel 4 on or off.

Pressing the key within 10 seconds of pressing the F key will turn the Tone Alert function on or off.

⑥5 / S.DT key

This key is used to set memory channel 5 on or off.

Pressing the key within 10 seconds of pressing the F key will turn the DTSS function or the paging function of the sub band on or off.

⑦6 / M.DT key

This key is used to set memory channel 6 on or off.

Pressing the key within 10 seconds of pressing the F key will turn the DTSS function or the paging function of the main band on or off.

⑧M / TX.S key

This key is used to store the displayed data into memory.

Pressing the key within 10 seconds of pressing the F key will turn the TX.STOP function on or off.

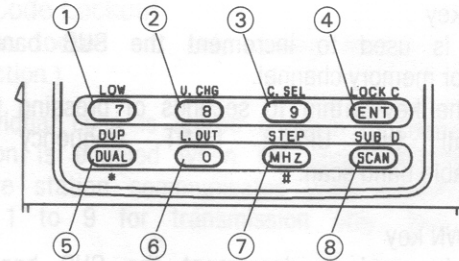

①7 / LOW key

This key is used to set memory channel 7 on or off.

Pressing the key within 10 seconds of pressing the F key will select the transmit output power level LOW, MEDIUM, or HI.

②8 / U. CHG key

This key is used to set memory channel 8 on or off.

After pressing the key within 10 seconds of pressing the F key, for the UHF band dual watch, this key is used to switch between the two UHF band frequencies used for the VHF band circuit.

③9 / C. SEL key

This key is used to set memory channel 9 on or off.

Pressing the key within 10 seconds of pressing the F key will display the current DTSS code. Use the numeric keys to select the desired DTSS CODE.

④ENT / LOCK key

This key is used to switch to the direct keyboard frequency entry mode.

Pressing the key within 10 seconds of pressing the F key will deactivate all functions except the POWER, LAMP, PTT, MONI, and F then ENT (LOCK).

If you press and hold the 7 key while you turn on the POWER switch the Tuning control lock function will turn off or on.

⑤DUAL / DUP/ * key

This key is used to set the SUB band ON or OFF.

Pressing the key within 10 seconds of pressing the F key will cause the duplex function to activate.

⑥0 / L.OUT key

This key is used to set memory channel 0 on or off.

Pressing the key within 10 seconds of pressing the F key will set the MEMORY CHANNEL LOCK OUT function on or off.

⑦MHz / STEP/# key

This key is used to select the tuning rate of the Tuning control. When the MHz indicator is lit, the Tuning control will cause the transceiver to increase or decrease in 1 MHz steps.

Pressing the key within 10 seconds of pressing the F key will display the current VFO tuning step. Use the tuning control to select the desired tuning step.

⑧SCAN / SUB (SCAN) key

This key is used to initiate main band scan.

Pressing the key within 10 seconds of pressing the F key will initiate sub band scan.

■ Operations of functions not displayed on panel

- Press the M key, then the key below.

Key	Function	Refer to
M then CALL	Store the displayed data in call channel.	P.25 4-4-5
M then MONI	DTMF Memory entry	P.37 4-7
M then SUB UP	Enter the displayed frequency in the upper limit frequency of the programmable VFO tuning limit.	P.19 4-2-4
M then SUB DWN	Enter the displayed frequency in the lower limit frequency of the programmable VFO tuning limit.	P.19 4-2-4

- Press and hold the key below and turn on the power switch.

Key	Function	Refer to
MONI + power ON	Select monitoring band.	P.9 MONI switch
CALL + power ON	Call key change to the Mode key.	P.10 CALL key
BAND + power ON	Speaker output band exchange	P.8 SP jack
TONE + power ON	Battery Saver function will turn on or off.	P.48 4-11
SHIFT + power ON	Automatic Power Off function will turn on or off.	P.48 4-12
1 + power ON	The 1 key on the remote control microphone (SMC-33)	P.53 SMC-33
2 + power ON	The 2 key on the SMC-33	P.53 SMC-33
3 + power ON	The 3 key on the SMC-33	P.53 SMC-33

Key	Function	Refer to
4 + power ON	Hold/resume mode of the VHF band	P.30 4-5-2
5 + power ON	Hold/resume mode of the UHF band	P.30 4-5-2
6 + power ON	DTMF Delay Time (2 seconds)	P.36 4-6-4
M + power ON	MEMORY RESET	P.23 4-4-2
7 + power ON	Tuning control lock function	P.13 ENT/ LOCK key
8 + power ON	Memory recall mode	P.26 4-4-6
9 + power ON	Exchange TX band	P.22 4-3
ENT + power ON	VFO RESET	P.23 4-4-2
DUAL + power ON	Speaker mode	P.8 SP jack
0 + power ON	Beep function on or off	P.17 4-2
MHz + power ON	DTSS delay time	P.40 4-8-4
SCAN + power ON	Tone alert sound between PiPiPi and PulPulPul	P.48 4-10



- Press the M key, the F key, then the key below sequentially.

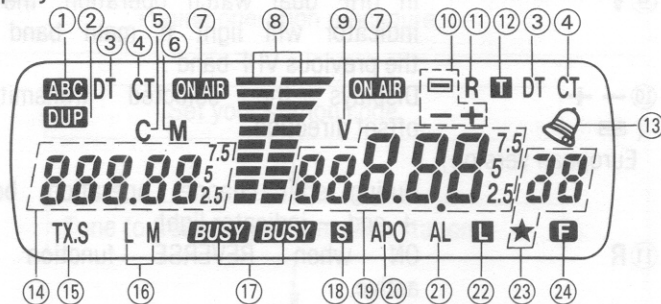

Key	Function	Refer to
M, F then SUB UP	Enter the displayed frequency in the upper limit frequency of the programmable band scan.	P.30 4-5-4
M, F then SUB DWN	Enter the displayed frequency in the lower limit frequency of the programmable band scan.	P.30 4-5-4
M, F then ENT	Clear the displayed memory channel data.	P.30 4-4-5

Display Panel



- ① **ABC** On when Automatic Band Change function has been activated.
- ② **DUP** On during duplex operation.
- ③ **DT** On when DTSS function is active
- ④ **CT** With the CTCSS unit TSU-7:
On when Tone Decode function is active.
- ⑤ **C** On when sub band frequency displays CALL channel.
- ⑥ **M** On when sub band frequency displays a memory channel.
- ⑦ **ON AIR** Displays operating transmitter band.
- ⑧  This level meter indicates the relative receive input strength or battery voltage level during transmit.

- ⑨ **V** in UHF dual watch operation, the V indicator will light if main band is the previous VHF band.
- ⑩ **- +**

 European version)
 Displays the selected transmitter offset direction.
 During split channel operation, both + and - indicator light.
- ⑪ **R** ON when REVERSE function is active.
- ⑫ **T** On when TONE ENCODE function is active.
- ⑬  On when TONE ALERT function is active.
 The indicator flashes when receiving a signal.
- ⑭ 
 Displays the operating frequency to the nearest kHz, the frequency step size, or the tone frequency of the sub band.
 Flashes during scanning.
- ⑮ **TX.S** On when TX STOP function is active.
- ⑯ **L M** Displays the selected output power, i.e. Low, Medium, and no indicator Hi.

- ⑰ **BUSY** On when squelch is open.
- ⑱ **S** On when BATTERY SAVER function is active.
- ⑲ 
 Displays the operating main band frequency to the nearest kHz, the frequency step size, or the tone frequency.
 Flashes during scanning.
 ON in paging mode.
 ON in automatic dial mode.
- ⑳ **APO** ON when AUTOMATIC POWER OFF function is active.
- ㉑ **AL** ON when PRIORITY ALERT function is active.
- ㉒ **L** ON when LOCK function is active.
- ㉓ 
 Displays the current Memory Channel number. The star ★ indicator is on when the Memory channel will be skipped during Memory Channel Scan.
- ㉔ **F** ON whenever the F key is depressed.

4-2. RECEIVER OPERATION

Audio confirmation is provided whenever a front panel key is depressed. To disable this function press and hold the 0 key, then turn on the Power switch.

4-2-1. Receiver Operation

Connect the battery pack and the supplied antenna.

Set the controls as follows:

1. Press the power switch for longer than 0.1 second..

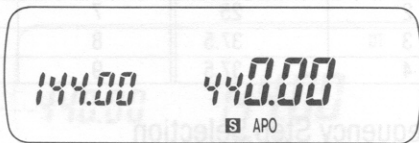

The frequencies shown above are the default frequencies after a microprocessor reset. If the display shows incomplete data or you think the displayed frequency is in error, reset the microprocessor Memory Initialization on page 23.

MAIN BAND

2. Rotate the MAIN VOL control clockwise until a UHF signal or noise is heard coming from the speaker.
3. Rotate the tuning control to select an open channel.
4. Rotate the UHF SQL control clockwise until the noise just disappears and the BUSY indicator turns off. This point is known as the Squelch Threshold point.

5. Select the desired operating frequency using the tuning control.

SUB BAND

6. Rotate the SUB VOL control clockwise until a VHF signal or noise is heard coming from the speaker.
7. Press the UP/DWN key to select an open channel.
8. Rotate the VHF SQL control clockwise until the noise just disappears and the BUSY indicator turns off.
9. Select the desired operating frequency using the UP/DWN key .
10. When a signal is received the main/sub S-meter will deflect and the main /sub BUSY indicator will turn On.
11. To proportion the volume between the MAIN band and SUB band, rotate the VOL control to the desired point.

Single band reception

13. Press the DUAL key. The SUB band frequency display will turn off.

4-2-2. Frequency Selection

Rotate the Tuning control to select the MAIN band frequency. Press the UP/DWN key to select the SUB band frequency.

- Direct keyboard frequency entry

1. Press the ENT key to select the ENTER mode.

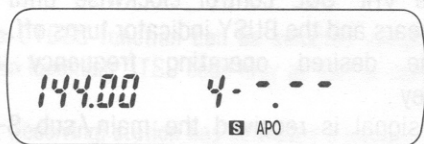

2. Within 10 seconds of pressing the ENT key enter the frequency from most significant digit to the least significant digit.

The transceiver changes frequency after 1 kHz digits have been entered (1 kHz digit is not displayed).

If 1kHz digit indicator flashes, enter the 1 kHz digit frequency.



Before entering 1kHz digit 5 indicator may flash.

If you make an error before entering all digits, press the ENT key twice, then reenter all.

In 12.5 kHz, or 25 kHz step size direct frequency selection will be completed in the 10 kHz digit. When you enter the following keys for the 10 kHz digit, 1 kHz and 100 Hz digit frequencies are automatically selected from the list below.

10 kHz digit.	Frequency kHz	10 kHz digit.	Frequency kHz
0	00	5	50
1	12.5	6	62.5
2	25	7	75
3	37.5	8	87.5
4	37.5	9	87.5

4-2-3. Frequency Step Selection

To select the desired tuning or scan step size use the following procedure:

1. Press the F key momentarily, then press the MHz/STEP key. The current frequency step size will be displayed.

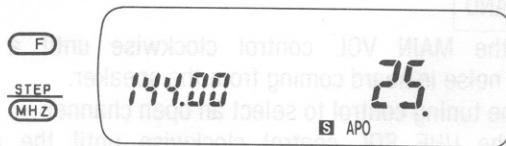

2. Rotate the Tuning control until the desired tuning step size appears in the display. The frequency step is indicated as shown below.

144 MHz band

5 ⇄ 10 ⇄ 15 ⇄ 20 ⇄ 12.5 ⇄ 25 ⇄ 5

430 MHz band

10 ⇄ 20 ⇄ 12.5 ⇄ 25 ⇄ 10

3. To complete the programming of the step size you can press the MHz/STEP key or simply wait 10 seconds and the microprocessor will automatically return to the normal frequency display.

The chart below illustrates the way the displayed frequency will change when you change from one step size to another.

For example:

Assume you are presently displaying a frequency of 439.920 MHz and had previously selected a 20 kHz step size. If you were to change the step size to 12.5 kHz the display would then read 439.925 MHz.

5,10,15,20 to 12.5,25

0,5,10,15	0
20,25,30,35	25
40,45,50,55	50
60,65,70,75, 80,85,90,95	75

12.5,25 to 5,10,15,20

0	0
12.5	10
25	20
37.5	30
50	50
62.5	60
75	70
87.5	80

4-2-4. Programmable VFO Tuning Limits

The radio provides the capability of programming the VHF or UHF VFO tuning range, in 1 MHz band segments, as well as providing a separate programmable band scan function. (See section 4-5.) For example you could tell the transceiver that you only wish to tune the 144.000 MHz and 145.000 MHz band segment by specifying any frequency within these two segments. The Tuning controls would then only tune within these specific bands. The procedure for specifying the bands is described below.

1. Rotate the Tuning control until the desired lower tuning range appears on the frequency display. For example you might want to select the 144 MHz band and dial up 144.100 MHz.
2. Press the M key, then press the ▽ key.
3. Rotate the Tuning control until the desired upper tuning range appears on the frequency display.
4. Press the M key, then press the △ key.
5. To confirm that the programming was properly performed rotate the Tuning control.

The transceiver should not go above or below the programmed band limits.

6. To clear both programmed limits simultaneously, initialize the VFO memory (VFO RESET). You can reprogram either limit independently by following the appropriate instructions above.

4-2-5. A.B.C (Automatic Band Change)

The A.B.C. function allows you to exchange the contents of SUB band to the MAIN band automatically whenever a signal is received in the SUB band and SUB squelch is open. When the sub band is the TX band all the following band changes are reversed.

1. Press the F key, then press the BAND / A.B.C key. The A.B.C. indicator will turn on in the display.
2. As soon as a signal is received in the SUB band, band change occurs.

The Tuning control is ineffective during this change.



3. If PTT switch is pressed, the A.B.C. function is released.

If PTT switch is not pressed, within 3 seconds after the signal goes off, the MAIN band is restored to its original frequency.

If BAND key is pressed, the MAIN band is restored to its original frequency upon receiving the signal, and the ABC function is on.

4-2-6 U×U

(430 MHz Band Simultaneous Reception)

1. Set the main band to 144MHz in the VFO mode.
2. When the U×U key is pressed the main band will be set to 430 MHz and the V indicator will light. (The V indicator lights when the main band is using the 144 MHz band circuit.)

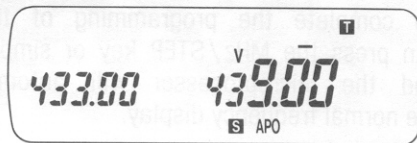

When the 430 MHz band is received using the 144 MHz band circuit, the sensitivity is lower than with the 430 MHz band circuit.

The 144 MHz band circuit can be changed as follows:

Press the F key, then press the 8/U CHG key. The V indicator will turn off in the display. (When the sub band is using the 144 MHz band circuit, the V indicator does not light.)

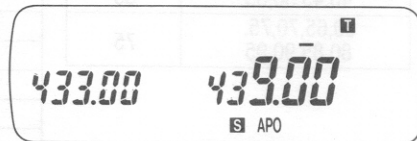

4-3. TRANSMITTER OPERATION

NOTE

1. Ensure that an antenna with a low standing wave ratio (less than 1.5 SWR) is attached to the antenna connector before attempting to transmit. Failure to provide proper termination may result in damage to the final amplifier section.
2. Always check that the frequency is clear before transmitting.

1. Select the desired operating frequency in the main band using any of the methods previously discussed.
2. Check the frequency to see if it is occupied before you transmit.
3. Press the PTT switch. The ON AIR indicator will light, and the battery level meter will light.
4. Speak into the microphone. The recommended distance to the microphone is 5 cm (2 inches).

NOTE

Talking closer may result in overdeviation of your transmit signal, which might be reported as a loss of clarity or an excessively wide transmit signal. Talking too far away may result in reports of weak audio.

5. Release the PTT switch to return to the receive mode. The ON AIR indicator should go out, and the battery level meter will return to zero.

■ TX.STOP function

Pressing the M / TX.S key within 10 seconds of pressing the F key will set the TX.STOP function on or off.

■ Duplex Operation

Pressing the DUAL / DUP key within 10 seconds of pressing the F key will cause the duplex operation to activate. DUP indicator will light. Pressing the PTT switch allows simultaneous receive on a UHF (VHF) and transmit on the other band.

NOTE

In the UHF dual watch operation the radio cannot simultaneously receive and transmit.

Receiver sensitivity may be suppressed with certain combinations of transmit and receive frequencies.

Use of earphone causes no howling.

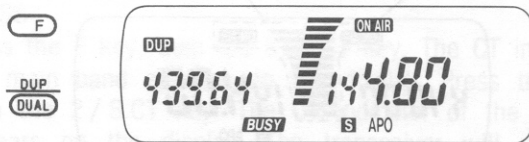

■ Simplex operation

Pressing the DUAL key sets the Sub band on or off.

DUP
DUAL



■ Exchange the TX band

If you hold and press the 9 key while you turn on the power switch you change the TX band.

Lights when the SUB band is the TX band.

Lights when the MAIN band is the TX band.

C. SEL
9

POWER

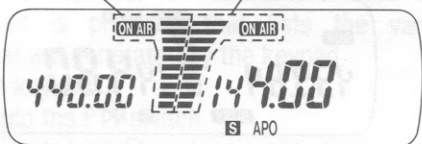

■ Changing Transmitter Output Power

Pressing the 7 / LOW key within 10 seconds of pressing the F key will allow you to select three different transmitter output power levels. The actual transmitter

output power for this unit depends on the power supply being used.

- H (High power)
Set the switch to this position for maximum output power.
- M (Medium power)
- L (Low power)
Set the switch to L for short-distance communication.

Output Power (W)

	144MHz			440/430MHz		
	H	M	L	H	M	L
Alkaline Battery	2.5	2.0	0.5	1.5	1.5	0.5
PB-5,6,7,9,10	2.5	2.0	0.5	1.5	1.5	0.5
PB-8	5	2.5	0.5	5	2.5	0.5
Ex. power supply (13.8VDC)	5	2.5	0.5	5	2.5	0.5

4-4. MEMORY

4-4-1. Microprocessor Memory Back-up

A lithium battery is contained in this transceiver to retain memory. Tuning OFF the POWER switch, disconnecting the power cable or an intermittent power failure will not erase the memories. The battery life is estimated at 5 years. When the battery has been exhausted erroneous information might appear in the display.

Lithium battery replacement should be performed by an authorized KENWOOD service facility, or your authorized KENWOOD dealer. This equipment contains CMOS circuitry and can be damaged by improper replacement procedures.

4-4-2. Microprocessor Initialization

MEMORY RESET

Press and hold the M key and turn on the POWER switch. All the LCD indicator will light. Release the M key. All user programmed data will be initialized.

VFO RESET

Press and hold the ENT key and turn on the POWER switch to reset the microprocessor's VFO memory, without destroying the memory channel, automatic dialer DTMF memory channel, Programmable VFO tuning range, or call channel data.

The initial state of the microprocessor, as delivered from the factory is shown in the chart below.

	144 MHz band	440/430 MHz band
VFO frequency	144 MHz	440/430 MHz
Call channel frequency	144 MHz	440/430 MHz
Frequency step	5 kHz or 12.5 kHz	25 kHz
Tone frequency	88.5 Hz (※)	88.5 Hz (※)

※Only when CTCSS unit TSU-7 is installed.

4-4-3. Memory Channel

This transceiver provides 40 memory channels for UHF and VHF bands.

In addition to serving as a normal memory channel, memory channel 1 is used to store the frequency for the Priority Alert function.

4-4-4. Memory Contents

Each memory channel is capable of storing the following information:

(○:Can be stored in memory, NA : Cannot be stored in memory.)

channel	Normal channel	Split channel
RX frequency	○	○
TX frequency	NA	○
Tone(CTCSS) frequency Tone (CTCSS) status	○	○
Frequency step	○	○
Shift status REV status	○	NA
※ DTSS code DTSS status	○	○

(※) When the TX frequency is entered in the memory, the shift state and reverse on/off set for the receive frequency are deleted from the memory.

4-4-5. Memory Entry

● Normal Channel Entry or Odd Split Channel RX Frequency Entry

- Using the ENT key and numeric keys select the desired receiver frequency, tone information etc.
- Press the M key momentarily. The memory channel indicator will flash.

M

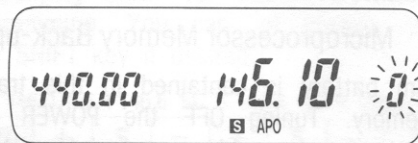

- Select any memory channel (00 ~ 39) using the numeric keys. To enter data in memory a 2-digit number is used.

For example CH 5 is channel 05, and CH 15 is channel 15.

Memory channel number will turn off. This indicates that the receiver data has been properly stored in memory.

● TX frequency entry (Split channel only)

NOTE

When the RX frequency is rewritten in the odd split channel, the TX frequency of the channel is automatically erased.

- Using the ENT key and numeric keys select the desired transmitter frequency.
- Press the M key momentarily. The memory channel indicator will flash.
- Press and hold the PTT switch and select the memory channel (00 ~ 39) using the numeric keys.
- The TX frequency is set and the system returns to the state before writing.

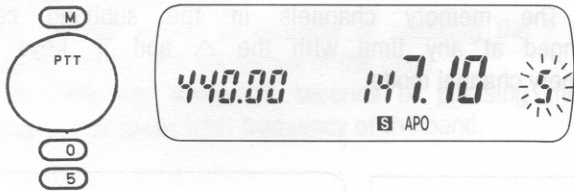

NOTE

When nothing is stored in a memory an error sound is heard recalling the memory.

● To confirm the contents of the split channel



1. Press the memory channel number key. The programmed RX frequency appears on the display with “-” and “+” offset direction indicators. This indicates that this channel has an odd split entered.
2. To check the TX frequency press the REV key or the PTT switch. The transmit frequency will appear in the display.

● Call Channel entry

1. Select the desired Call channel frequency, tone data etc in the VFO mode using the ENT key and numeric keys.
2. Press the M key momentarily then press the CALL key within 10 seconds of pressing the M key .
3. Odd split Call channel
Select the desired Call channel TX frequency, tone data etc .
4. Press the M key momentarily,
5. Press and hold the PTT switch and press the CALL key.
6. Release the PTT switch.

● Clearing a Memory Channel

If you want to clear the contents of an individual memory channel use the following procedure.

1. Select the memory channel you wish to clear.
2. Press the M key, F key, then ENT key.
3. The selected memory channel number will disappear and the next active memory channel will appear.

4-4-6. Memory Channel Recall

CAUTION

If nothing is stored in the channel, the memory cannot be recalled and an error tone sounds.

The memory can be recalled in the following ways:

	display
One-digit input:	Both-band recall (initial setting):
One-digit input:	Page recall:
Two-digit input:	In-band recall:
Two-digit input:	Both-band recall:
One-digit input:	In-band recall:

ALL1
PAG E
bAnd2
ALL2
bAnd1

When the power is switched on while holding down the 8 / U CHG key, the system enters the memory recall setting mode.

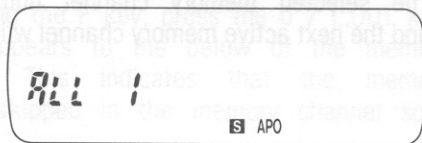

Select the appropriate recall mode using the \triangle and ∇ keys. If 10 seconds elapse after selection or a key other than the \triangle and ∇ keys is pressed, the setting is canceled, and the system returns to the mode before the setting.

■ The subband does not indicate any channels, but only M. The memory channels in the subband can be changed at any time with the \triangle and ∇ keys in the memory channel mode.

One-digit Input

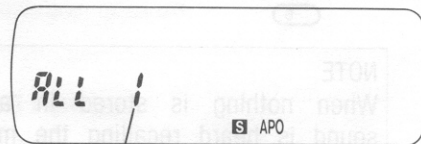

Number 1 indicates the one-digit input mode.

The one-digit input mode is useful mainly to use only channels 0 to 9. Any of channels 0 to 9 can be directly recalled simply by pressing its number key. Then rotate the Tuning control to select 10 to 39. To return to the VFO mode, press that key again.

Two-digit Input

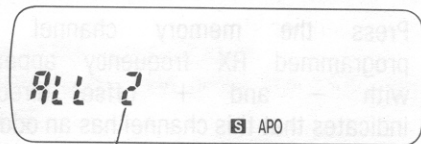

Number 2 indicates the two-digit input mode.

In this mode, numbers 00 to 09 are entered to recall channels 0 to 9 respectively. All channels 00 to 39 can be directly recalled using the numeric keys. To return to the VFO mode, press that key.

In-band Recall

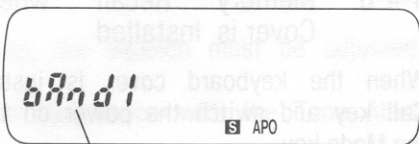

bAnd indicates in-band recall.

Only channels having the memorized frequencies in the main band are displayed.

Both-band Recall

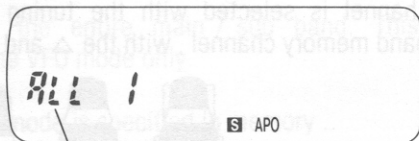

ALL indicates both-band recall.

The main band and subband are displayed according to the frequencies stored in memory.

Page Recall

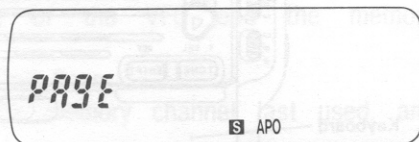

In this mode, any of channels 00 to 39 can be recalled by entering one digit. Channels are divided into four pages: channels 0 to 9, 10 to 19, 20 to 29, and 30 to 39.

When one of 0 to 9 is entered, the pages are searched from page 1 for the channel whose rightmost digit equals the entered digit. The memory channel having the same bandwidth as the first main band that is matched is recalled.

When the LAMP key is pressed and one of 0 to 9 is entered while the lamp is on, the pages are checked beginning with page 4.

For example, suppose the main band is the VHF band and the above frequencies are kept in memory for channels 5, 15, 25, and 35. If the 5 key is pressed, channel 5 is passed because it is in the UHF band, and channel 15 in the VHF band is recalled.

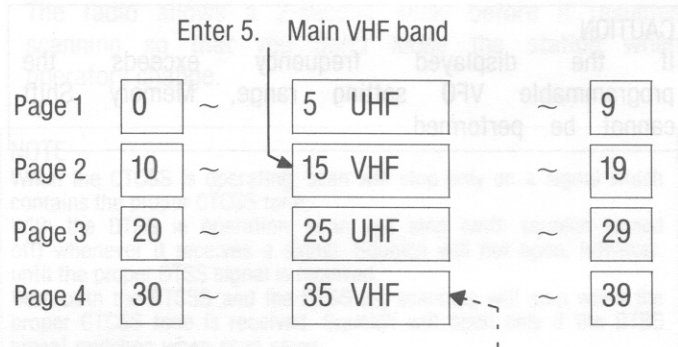

Press the LAMP key, then enter 0 to 9.

If channels 0 to 9 are stored in memory for the UHF band and channels 10 to 19 are stored in memory for the VHF band in this way, channels 00 to 39 can be recalled by a single touch of a key.

4-4-7. Memory Shift

Press the ENT key twice to copy the contents of a memory channel or call channel to the VFO without changing the data in memory. This will allow you to begin tuning at the point specified by the memory channel data.

If an Odd Split Memory channel is selected, only the receive data is copied.

CAUTION

If the displayed frequency exceeds the programmable VFO setting range, Memory Shift cannot be performed.

4-4-8. Memory Recall when the Keyboard Cover is Installed

When the keyboard cover is installed, hold down the Call key and switch the power on to use the Call key as the Mode key.

Each time the Mode key is pressed, the mode is switched between the VFO, Memory channel, and Call channel mode.

In the Memory channel mode, the main band memory channel is selected with the tuning control, and the sub-band memory channel, with the Δ and ∇ keys.

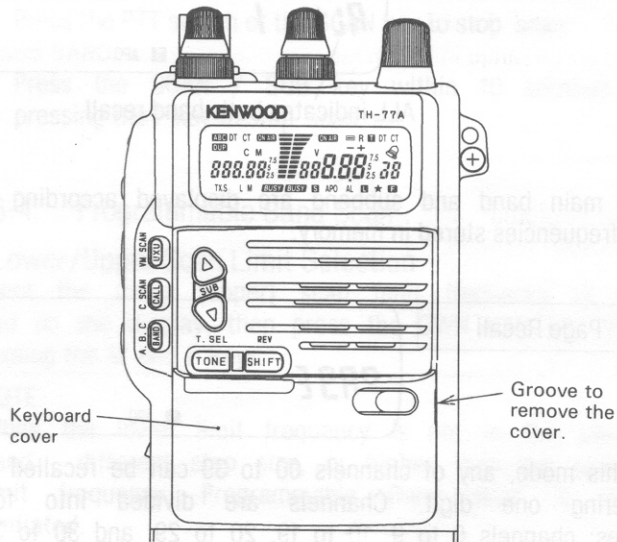

4-5. SCAN

For proper scan operation the squelch must be adjusted to the threshold point.

Scan cannot be used in conjunction with the Tone Alert function.

4-5-1. Scan Options

The following scan options are available:

Band Scan

Scan proceeds over the entire main / sub band. This function operates in the VFO mode only.

Programmable Band Scan

The scan range in this mode is specified in memory .

MHz Scan

Scans over a 1 MHz range.

Memory Scan

Scan proceed thru those memory channels that have data stored and have not been locked out. This function operates the in memory mode only.

VFO / Memory Scan

Alternate scanning of the VFO and the memory channel last used.

V/M/C (VFO/Memory/Call) Scan

Scans the VFO, the memory channel last used, and the call channel.

CALL / VFO Scan

Alternate scanning of the call channel and VFO.

CALL / Memory Scan

Alternate scanning of the call channel and the memory channel that was last used.

4-5-2. Hold/Resume Programming

Two type of scan hold / resume are provided in this transceiver.

Time Operated Scan

In this mode the radio stops on a busy channel, remains there approximately 5 seconds, then continues to scan even if the signal is still present.

Carrier Operated Scan

In this mode, the radio stops scanning on a busy channel and remains there until the signal drops out. The radio allows a 2-second delay before it resumes scanning so that you don't loose the station when operators change.

NOTE

When the CTCSS is operating, scan will stop only on a signal which contains the proper CTCSS tone.

With the DTSS in operation, scan will stop (with squelch turned off) whenever it receives a signal. Squelch will not open, however, until the proper DTSS signal is received.

With both the CTCSS and the DTSS on, scanning will stop when the proper CTCSS tone is received. Squelch will open only if the DTSS signal matches when scan stops.

The radio is delivered from the factory in the Time Operated Scan mode. To switch between the modes, use the following procedure:

● Hold/Resume selection

VHF band Press the 4 key while turning on the power switch.

UHF band Press the 5 key while turning on the power switch.

4-5-3. Band Scan

1. Adjust the SQL control to the threshold point.

2. MAIN BAND;

Press the SCAN / SUB key in the VFO mode to initiate scan.

SUB BAND;

Press the SCAN key within 10 seconds of pressing the F key.

The MHz indicator will begin flashing to indicate that the radio is scanning.

NOTE

Main band scan stops by pressing the F key. So sub band scan must be started before main band scan.

3. Scan begins in the upwards direction.

MAIN BAND;

You can reverse the direction by turning the Tuning control.

SUB BAND;

You can reverse the direction by pressing the UP/DWN key.

The tuning step size depends on the current Frequency Step selection.

4. Scan stops on a busy channel, i.e. a station strong enough to open squelch and set the BUSY indicator on.

5. MAIN BAND;

Press the PTT switch or the SCAN key to stop scan.

SUB BAND;

Press the SCAN / SUB key within 10 seconds of pressing the F key to stop scan.

4-5-4. Programmable Band Scan

● Lower/Upper Scan Limit Selection

Select the lower (upper) scan limit frequency of the band on the display, then press the DWN (UP) key after pressing the M and F keys.

NOTE

When the lower limit frequency is not in the same band, different step size, or higher than the upper limit frequency, Programmable Band scan is not initiated.

● Scan Limit Confirmation

Press the UP key within 10 seconds of pressing the F key to display the upper limit frequency of the band.

Press the DWN key within 10 seconds of pressing the F key to display the lower limit frequency of the band.

● Initiate

1. Adjust the SQL control to the threshold point.
2. Select a frequency between the two programmed scan limits.

Continue to 4-5-3 step 2.

4-5-5. MHz Scan

1. Adjust the SQL control to the threshold point.
2. Press the MHz key during band scan or programmable band scan. The MHz indicator will begin flashing as a visual reminder the transceiver is scanning.
3. Scanning will start in an upwards direction over a 1 MHz range.

Continue to 4-5-3 step 3.

4-5-6. Memory Channel Scan

Note

Only those memory channels that have data entered and that have not been locked out are scanned.

Scan does not start unless more than 2 channels have data entered.

1. Adjust the SQL control to the threshold point.
2. Press any numeric key to select memory channel mode.

Continue to 4-5-3 step 2.

4-5-7. VFO / Memory Channel Scan

1. Adjust the SQL control to the threshold point.
2. Press the F key, then the U × U / VM SCAN key to initiate VFO / Memory scan.
3. Alternate scanning of the VFO frequency shown on the display and the memory channel last used.

Continue to 4-5-3 step 5.

4-5-8. Call Scan

CALL / VFO Scan

Press the F key, then the CALL / C SCAN key in the VFO mode to start alternate scanning of the VFO frequency shown on the display and the call channel.

CALL / Memory Channel Scan

Press the F key, then the CALL / C SCAN key in the memory channel mode to start alternate scanning of the call channel and the memory channel last used.

4-5-9. V/M/C (VFO/Memory/Call) Scan

In the call channel mode press the F key, and then the CALL / C SCAN key to scan the VFO frequency shown on the display, the memory channel that was last used and the call channel in turn.

4-5-10. Memory Channel Lockout

This function allows you to specify which memory channels you wish to skip during memory channel scan.

1. Select the memory channel in the main band that you wish to skip by pressing the numeric keys.
2. Press the F key. The F indicator lights. Within 10 seconds of pressing the F key, press the 0 / L.OUT key. A ★ indicator appears to the below of the memory channel number. This indicates that the memory channel will be skipped in the memory channel scan mode.

F

L. OUT
0

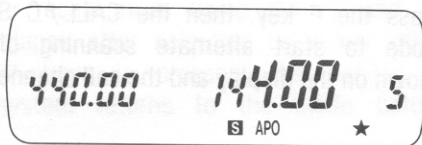

3. Repeat steps 1 and 2 to lock out any other channels you wish to skip.
4. To cancel the lockout, select the desired memory channel as described in steps 1, and 2 above. A ★ indicator appears to the below of the memory channel number. Press the F key and then press the 0 / L.OUT key. The ★ indicator goes off.

4-5-11. Priority Alert Function

The Priority Alert function allows you to monitor memory channel 1 once every 5 seconds for activity even when you are tuned to a different channel number.

1. Ensure the frequency you wish to monitor has been entered in memory channel 1. (The Priority Alert function is effective when the frequency of memory channel 1 is in the sub band frequency range or not displayed frequency during the simplex operation.)
2. Adjust the SQL control to the threshold point.
3. Press the F key momentarily, then press the 1/AL key. The AL indicator goes on.

AL
1

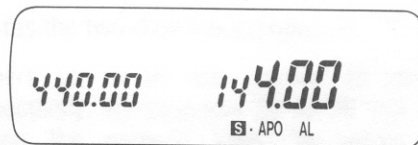

- If a signal is present a beep is heard from the speaker.
- To turn this function off repeat step 3. The AL indicator goes off.

NOTE

- The CTCSS function activated in memory channel 1 is not checked in the Priority Alert function.
- While memory channel 1 is being scanned you will not hear voice communications, only a beep is heard if a signal is present.
- The Priority Alert function is cancelled when the DTSS, or Paging function is selected.

4-6. REPEATER OPERATION

4-6-1. Transmitter Offsets

All amateur radio repeaters use a separate receive and transmit frequency. The receive frequency may be above or below the transmit frequency. The configuration of most repeaters fall into one of the categories listed below:

	VHF band	UHF band	UHF band European version only
+	+600 kHz	+5 MHz	+1.6 MHz
-	-600 kHz	-5 MHz	-1.6 MHz
--			-7.6 MHz

● Offset Direction

To select the desired transmitter offset direction press the SHIFT key. Each time you press these keys the transceiver advances from one direction to the other, i.e. “+” to “-” (“-” to “--” with European versions) to no offset (simplex).

● Automatic Offset Selection (U.S.A., Canada and Oceania versions)

The TH-77A is programmed according to the standard ARRL (Amateur Radio Relay League) Band Plan with regard to transmitter offset direction.

See the accompanying chart for additional information about this programming. You can, of course, override this by using the SHIFT key if desired.

145.1	145.5	146.0	146.4	146.6	147.0	147.4	147.6	148.0	
S	-	S	+	S	-	+	S	-	S

S : simplex

4-6-2. Reverse Function

Some repeaters use a “Reverse Pair”, i.e. the transmit / receive frequencies are the reverse of other repeaters. For example, repeater A uses 146.000 for a transmit frequency (INPUT) and 146.600 for a receive frequency (OUTPUT). Repeater B might use 146.600 for a transmit frequency and 146.000 for a receive frequency. It would be inconvenient to have to reprogram the transceiver each time you wanted to use these repeaters.

The SHIFT / REV key allows you to easily reverse the transmit and receive frequencies. To use the REV function press the F key, then the SHIFT / REV key. The R indicator goes on on the display to indicate that you are working a reverse pair.

To return to normal press the F key, then the SHIFT / REV key again. The R indicator goes off.

This function is also useful to check the input frequency of the repeater so that you can determine if you are within range for simplex communications.

4-6-3. Tone and CTCSS Operation

Some repeaters require the use of a control signal to activate the repeater. Several different methods are currently in use.

In the United States sub-audible tones are sometimes used. 38 different Sub-audible frequencies are possible. You will be able to operate in a Tone Operated Squelch Mode. The CTCSS function has been activated the radio will not open squelch until the proper PL tone is received.

In Europe and United Kingdom a 1750 Hz tone is used in transmit. Press and hold the TONE key to transmit with the access tone, you need not press the PTT switch. Since this tone is required in Europe and the United Kingdom a 1750 Hz tone encoder is included with models delivered to these countries.

The CTCSS unit (TSU-7) is not included with models except U.S.A and Canadian version.

● Tone Frequency Selection

1. Press the F key. The F indicator will light. Press the TONE / T.SEL key within 10 seconds of pressing the F key. The current tone frequency will show in the display.
2. Rotate the Tuning control to select the desired tone frequency.

3. When the desired tone frequency is selected, the previous mode is resumed 10 seconds after selection or when the TONE / T.SEL key is pressed.

Tone Frequency (Hz)

67.0	82.5	97.4	114.8	136.5	162.2	192.8	233.6
71.9	85.4	100.0	118.8	141.3	167.9	203.5	241.8
74.4	88.5	103.5	123.0	146.2	173.8	210.7	250.3
77.0	91.5	107.2	127.3	151.4	179.9	218.1	
79.7	94.8	110.9	131.8	156.7	186.2	225.7	

● Tone/CTCSS Operation

Tone :

Press the TONE / T.SEL key. The T indicator appears on the display and the transmitter will transmit the desired tone.

CTCSS :

Press the F key, then the 3 / M.CT key. The CT indicator of the main band appears on the display. Press the F key, then the 2 / S.CT key. The CT indicator of the sub band appears on the display. The transceiver will operate in the Tone Squelch mode, i.e. squelch will not open until the same tone is received as a portion of the incoming receive signal.

NOTE

If CTCSS function is turned on in the sub band while Tone is on in the Main band during duplex operation, CTCSS is not activated during transmitting

4-6-4. Autopatch Operations (U.S.A. versions only)

Some repeaters offer a service known as autopatch. This feature allows you to dial a telephone number from your transceiver and carry out a telephone conversation, much like a car telephone, or cellular telephone. This function requires the use of a DTMF (Dual Tone Multi Frequency) pad. In addition to the normal 12 keys that are found on your telephone the transceiver also provides 4 additional keys, A, B, C and D. These keys are required by some repeater systems for various control operator of your repeater to determine if their use is required. A chart is provided that lists the various tone frequencies that are generated by the keypad.

To activate the keypad:

1. Press and hold the PTT switch.
2. Press the keys just like you would dial you telephone at home.

NOTE

Some repeaters will require the use of a special key sequence to activate the autopatch function. You should check with your control operator for this sequence.

(Hz)	1209	1336	1477	1633
697	1	2	3	A(F)
770	4	5	6	B(M)
852	7	8	9	C(ENT)
941	*	0	#	D(SCAN)

If one of the keys is pressed after the BAND key has been pressed during transmission, a single tone will be heard.

key	(Hz)	key	(Hz)
1	697	5	1209
2	770	6	1336
3	852	7	1477
4	941	8	1633

● Delay Time Selection (Direct keyboard Entry only)

You can select the transceiver remaining keyed for 2 seconds after pressing each number.

1. Turn the power switch off.
2. Press and hold the 6 key .
3. Turn on the power switch.
4. Release the 6 key .
5. Repeat step 1 to 4 to cancel the delay time.

4-7. DTMF MEMORY

DTMF telephone numbers, of up to a maximum of 15 digits, can be memorized.

● Storing the DTMF codes

1. Press the M key, then the MONI switch to select the DTMF codes entry mode.

TX, S
M

MONI

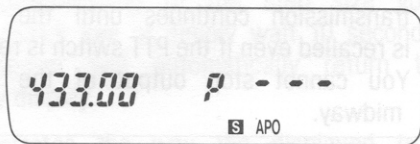

2. Enter the DTMF code on the DTMF code key (up to a maximum of 15 digits)

The DTMF code key

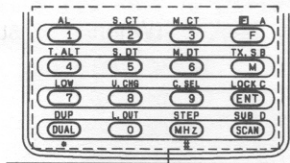

U.S.A. and Canadian version

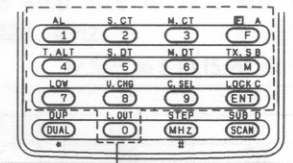

Except U.S.A. and Canadian version

5

4

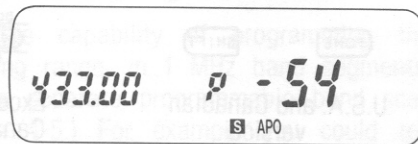

3. After the DTMF code is entered, press the BAND key (U.S.A. and Canadian version), or ENT key (other version)

A, B, C
BAND

LOCK
ENT

U.S.A. and Canadian version

Except U.S.A. and Canadian version

4. Select the channel (0 ~ 9) where you want to store the DTMF code and press the key for that channel. When the DTMF code is stored to that channel, the previously shown frequency reappears on the display.

NOTES

1. If you enter the wrong number, press the TONE key (U.S.A. and Canadian version) or the * key (other version) to start again before pressing the ENT key.
2. If you want to stop the entry midway, press the SHIFT key (U.S.A. and Canadian version) or the # key (other version). The previously displayed frequency appears on the display.

TONE

SHIFT

DUP
DUAL

STEP
MHZ

U.S.A. and Canadian
version

Except U.S.A. and
Canadian version

●Recalling stored DTMF code in receive mode

1. Press the F key, then the MONI switch.

F

MONI

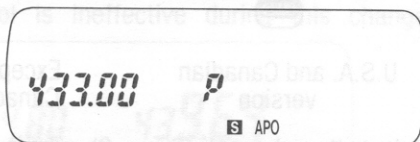

2. Press the numeric key (0 ~ 9). The DTMF code stored in the key is output to the display.
3. The code are displayed from right to left as shown.

例 1CH

1

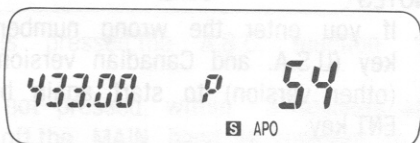

●Making a DTMF Call

Press the CALL key while holding the PTT switch down then press the numeric key for the channel where you stored the DTMF code in the receive mode.

The DTMF code is output .The display shows the code.

NOTES

1. While the stored DTMF code is being recalled, transmission continues until the whole code string is recalled even if the PTT switch is released.
2. You cannot stop output of the stored DTMF code midway.

4-8. DTSS (Dual Tone Squelch System)

This function allows squelch to be turned on in the receive mode on reception of a three-digit code matching the DTSS code selected in your radio.

Once squelch is turned on by reception of a matching code, it operates normally from then on. If no signal is received for longer than 2 seconds, squelch is turned off until a matching code is received.

NOTE

This function is not available in some areas.



The DTSS code may not be accepted if the repeater is “identifying”. If this should occur you should press the PTT switch again, and retransmit the DTSS code.

4-8-1. DTSS Code

DTSS codes from 000 through 999 can be selected from the VFO mode and stored in memory channels, and CALL channel.

4-8-2. DTSS Code Selection

1. Pressing the 9 / C. SEL key within 10 seconds of pressing the F key will display the current DTSS code. Enter a three-digit number on the key pad.

NOTES

1. If a key other than the numeric key is pressed during operation, code selection mode is canceled.
2. If no action is taken for longer than 10 seconds, code selection mode is automatically cancelled.

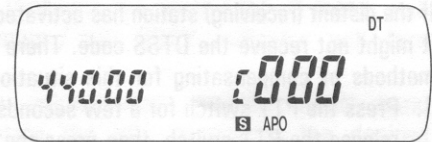

4-8-3. Using the DTSS Function

1. Adjust the SQL control to the threshold point.
2. MAIN BAND;
Press the F key, then the 6/M.DT key.
SUB BAND;
Press the F key, then the 5 /S.DT key.
The DT indicators begin to light.
3. RECEIVE
Squelch will open when the proper code is received.
TRANSMISSION
When the PTT switch is pressed, the code shown in the display is sent out for about 0.5 second.

NOTES

1. Voice output is muted during code output.
 2. We recommend that you turn off the battery saver function when you use the DTSS function.
4. To cancel the DTSS function press the F key, then the 6/M.DT key for the main band or the 5/S.DT key for the sub band.

NOTES

Although the CTCSS function can be selected simultaneously in both bands, an incoming DTSS code may be lost at certain timings.

If the distant (receiving) station has activated a battery saver circuit it might not receive the DTSS code. There are two recommended methods of compensating for this situation.

1. Press the PTT switch for a few seconds, send the DTSS code, release the PTT switch, then press the PTT switch again and resend the appropriate code.
2. Proper DTSS operation will occur if you ensure the battery saver circuit is disabled whenever you intend to operate using either the DTSS modes.

4-8-4. Using DTSS with a Repeater

The DTSS signal is transmitted after a short delay if the PTT switch is pressed. This is to avoid any malfunction due to the DTSS signal being interrupted by repeaters with long response times.

- Delay during DTSS output
A delay is built in when the DTSS is sent out.

Normal 250 mS
Shift, split channel ,or duplex operation
450 mS, or 750 mS

- To change delay time

1. Turn the power switch off.
2. Press and hold the MHz key.
3. Turn on the power switch.
4. Release the MHz key.

4-9. PAGING

The paging function is useful to call all members of a group, a specific station, or wait for a call from another station by using a DTMF (Dual Tone Multi Frequency) signal.

Example: When member 2 is called

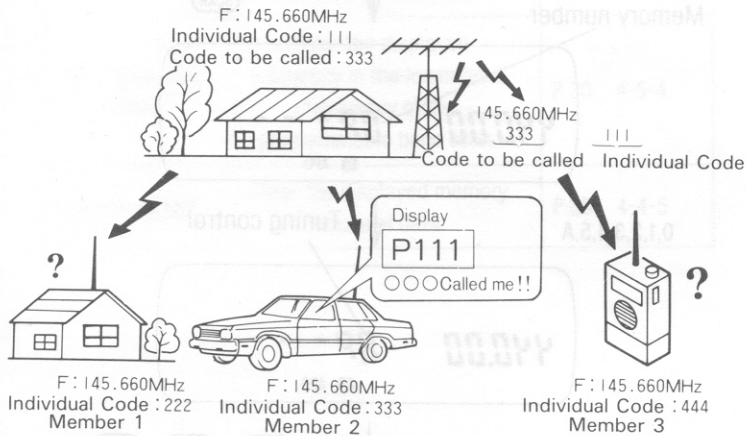

The common group code and individual codes should be determined in advance. These codes should be from 000 to 999 (3 digits). Unlike DTSS, the code of the calling station is displayed on the receiver, so the receiver can identify the calling station.

When called by a local station, the individual code the individual code of the calling station is displayed. When called with a group code, that group code is displayed.

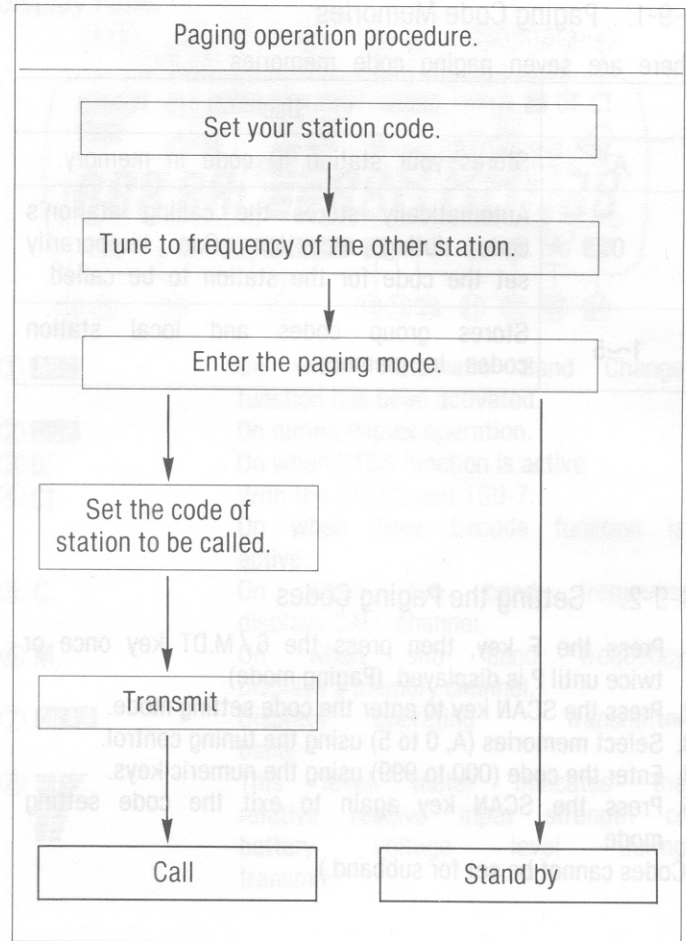

4-9-1. Paging Code Memories

There are seven paging code memories.

	Use
A	Stores your station ID code in memory.
0	Automatically stores the calling station's code during reception. Can temporarily set the code for the station to be called.
1~5	Stores group codes and local station codes in memory.

4-9-2. Setting the Paging Codes

1. Press the F key, then press the 6/M.DT key once or twice until P is displayed. (Paging mode)
2. Press the SCAN key to enter the code setting mode.
3. Select memories (A, 0 to 5) using the tuning control.
4. Enter the code (000 to 999) using the numeric keys.
5. Press the SCAN key again to exit the code setting mode.

(Codes cannot be set for subband.)

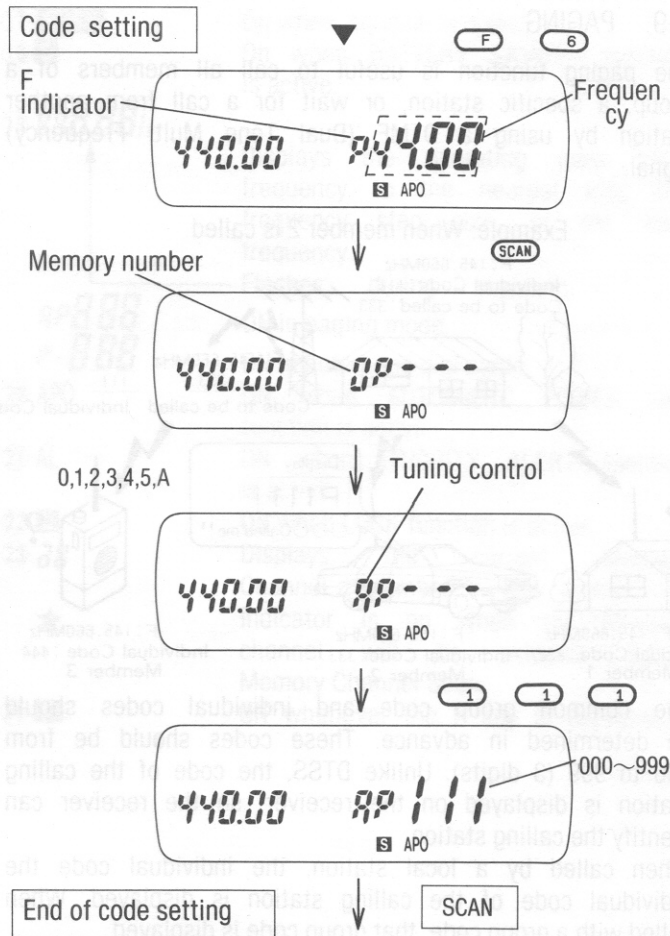

For example, the following groups communicate with each other.

Predetermined frequency	145.660MHz
Group code	789
Member 1	Individual Code 111
Member 2	Individual Code 222
Member 3	Individual Code 333
Member 4	Individual Code 444

<p>Member 1</p> <p>A 111</p> <p>0</p> <p>1</p> <p>2</p> <p>3 789</p> <p>4 444 ★</p> <p>5</p>	<p>Member 2</p> <p>A 222</p> <p>2 789</p> <p>0</p>	<p>Member 4</p> <p>A 444</p> <p>4 789</p> <p>0</p>
	<p>Member 3</p> <p>A 333</p> <p>3 789</p> <p>0</p>	

4-9-3. Paging Transmission (Calling)

Your station ID code is preset in memory A. (The local station ID code is always stored in memory A.)

1. Tune to the predetermined frequency.
2. Press the F key, then press the 6/M.DT key (5/S.DT key for a subband) to enter the paging mode.
The paging function of the other transceiver must be ON, too.
3. Press the SCAN key (F key, then SCAN key for a subband) to enter the code setting mode.
4. Use the tuning control to select the memory channel in which the local station code is stored.(△ ▽ keys for a subband).

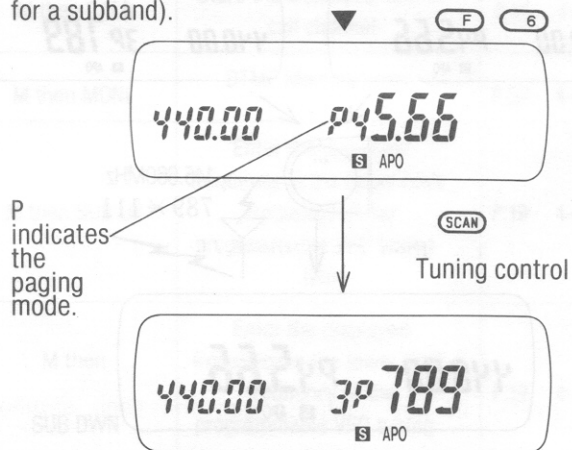

The PAGING code may not be accepted if the repeater is "identifying". If this should occur you should press the PTT switch again, and retransmit the PAGING code.

Calling all members of the group

To call all members of the group, select the memory channel in which the group code is stored. In this example, the group code is stored in number 3.

Press the PTT switch.

Communication is possible in both the paging mode and the code setting mode.

In the paging mode

440.00 P45.66
S APO

In the code setting mode

440.00 3P789
S APO

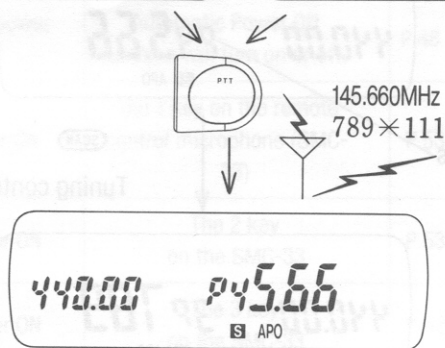

Group code 789 and your station ID code 111 are transmitted. After the codes are successfully transmitted, a DTMF tone sounds.

Calling a specific member

To call a specific member (for example, member 4), use the following procedure:

1. Select the memory in which the remote station code is stored (in this example, select memory 4.),
2. Enter the individual code of the remote station in memory 0.

Then press the PTT switch.

From memory

440.00 4P4.00
S APO

Enter the individual code to 0.

440.00 4P444
S APO

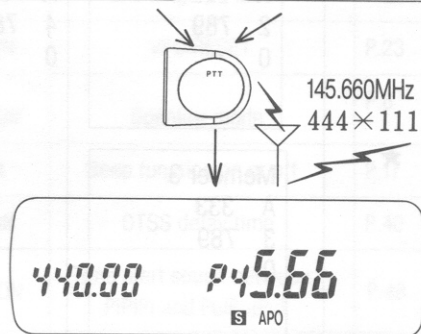

Remote station code 444 and local station ID code 111 are transmitted. After the codes are successfully transmitted, a DTMF tone sounds.

4-9-4. Paging Reception (Wait)

1. Tune to the predetermined frequency.
2. Press the F key, then press the 6/M.DT key (5/S.DT key for a subband) once or twice to enter the paging mode.

F

M.DT
6

S.DT
5

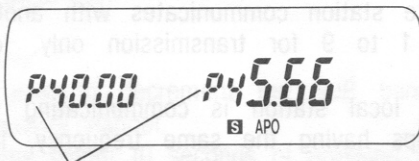

P indicates paging.

If the distant (receiving) station has activated a battery saver circuit it might not receive the PAGING code. There are two recommended methods of compensating for this situation.

1. Press the PTT switch for a few seconds, send the PAGING code, release the PTT switch, then press the PTT switch again and resend the appropriate code.
2. Proper PAGING operation will occur if you ensure the battery saver circuit is disabled whenever you intend to operate using either the PAGING modes.

Stand by with individual code

3. When called with your station ID code, the memory number automatically change to 0. The ID code of the calling station is displayed. (For KENWOOD's transceivers. This also applies to the following descriptions.) (Example: Frequency: 145.660 MHz, calling station code: 444)

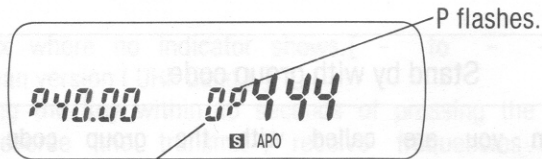

Zero is displayed to indicate that your station is being called.

4. The squelch is opened and the calling other party is heard. (The individual code of the calling station is stored in memory 0.)
5. Press the PTT switch to respond to the calling station.

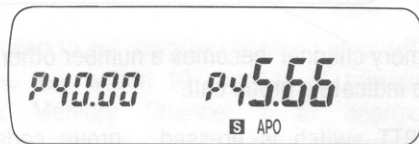

After the remote station has been called, cancel paging. Communication can be performed more efficiently.

(※ : If the remote station code can not be recognized, E appears on the display panel.)

ERROR
indicator

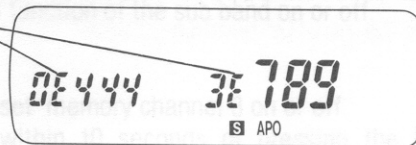

These codes are the previous ones.

Stand by with group code.

3. When you are called with the group code, the common group code and its memory channel number are displayed.
(Example: Wait with the main band. For member 2, group code 789 is stored in memory for 2CH.)

F indicator flashes

Group code



This memory channel becomes a number other than 0 to indicate a group call.

4. When the PTT switch is pressed, group code 789 (as displayed) and your station ID code are transmitted. You can participate in the group roundtable.

After the remote station has been called, cancel paging. Communication can be performed more efficiently.

4-9-5. Code Lockout

(A code is locked out only during reception with the paging function.)

If an individual code is stored in each of memories 1 to 9, reception is enabled when the codes match, even if one remote station communicates with another. To use memories 1 to 9 for transmission only, lock out the memories.

When the local station is communicating with two or more groups having the same frequency, lock out the group code with which stand by is temporarily stopped. (Group calling is possible.)

●Paging memory lockout

1. Enter the code setting mode and display the memory channel number (except memory 0) to be locked out using the tuning control.
2. Press the MHz key. (The MHz mode is not entered.) The ★ mark lights and the memory is locked out.
3. To cancel, repeat steps 1 and 2.

4-10. TONE ALERT SYSTEM

The Tone Alert function provides an audible alarm to indicate when someone is transmitting on the frequency you are monitoring. When the T.ALT function is set, you will not hear voice communication. When used in conjunction with the CTCSS function, this would allow the transceiver to act similar to a private paging system. During T.ALT operations, the Automatic Power Off function is disabled.

1. Adjust each SQL control to the threshold point.
2. If you will be using the CTCSS function, select the proper tone frequency and ensure the CTCSS indicator is on the display.
3. Press the F key, then the 4 / T.ALT key. Both T.ALT indicators light .
4. When a signal is present:
 - The T.ALT indicator flashes.
 - The BUSY indicator lights.
 - The transceiver will beep on and off for approximately 5 seconds.
 - The passing time is counted up.
5. The counting up time is displayed in minute. maximum of 99 hours 59 minutes. The display is rewritten by each new signal.
6. During time display the T.ALT function can be released by pressing PTT switch.

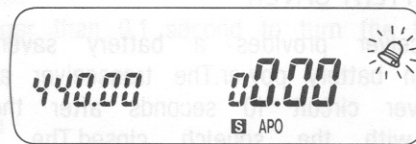

NOTE

1. When using CTCSS, the incoming signal must be present for approximately 1 second for the T.ALT to function properly.
 2. If the DTSS function is used in conjunction with the Tone Alert function, Tone Alert is activated only when the same DTSS signal is received.
7. The T.ALT function can be released by pressing the F key and the 4/T.ALT key again.

●Beep Sound Selection

Pressing and holding the SCAN key and turning on the power switch will switch the BEEP sound alternately between Pi Pi Pi and Pul Pul Pul.

NOTE

The Tuning control, PTT switch and all keys except MONI, LAMP, and F are ineffective during T.ALT operations.

4-11. BATTERY SAVER

The transceiver provides a battery saver mode to conserve on battery power. The transceiver activates the battery saver circuit 10 seconds after the last key operation with the squelch closed. The function is released by key operation or when squelch opens.

The function cannot operate during scan, or T.ALT operations. (Initial state is ON.)

To turn the battery saver function OFF/ON, first turn the POWER switch OFF and then press the TONE key while turning on the POWER switch.

TONE

POWER

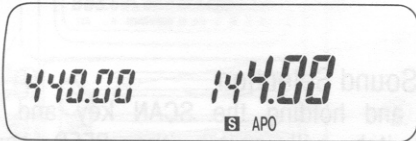

4-12. AUTOMATIC POWER OFF

This transceiver also provides an Automatic Power OFF circuit. The circuit action is described below. (Initial state is ON.)

1. A 5 second audio confirmation alert sounds after 59 minutes if no signal is received and if you have not performed any operation. One minute after this alert signal the transceiver switches the power off.
2. To turn the APO function OFF / ON, press the SHIFT key while turning on the POWER switch.

SHIFT

POWER

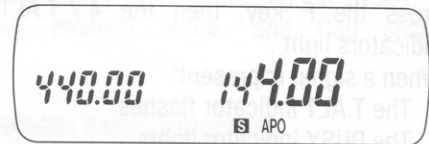

NOTE

The APO function does not activate during scan or the Tone Alert function in spite of the APO indicator.

The Tone Alert function has higher priority to the APO function.

6. MAINTENANCE

6-1. GENERAL INFORMATION

Your transceiver has been factory aligned and tested to specification before shipment. Under normal circumstances the transceiver will operate in accordance with these instruction manuals. All adjustable trimmers and coils in your transceiver has been adjusted at the factory and should only be readjusted by a qualified technician with proper test equipment. Attempting service or alignment without factory authorization can void the transceiver's warranty. When operated properly, the transceiver will provide many years of service without requiring realignment. The information in this section gives some general service procedures which can be accomplished without sophisticated test equipment.

6-2. SERVICE

Should it ever become necessary to return the equipment to your dealer or service center for repair, pack it in its original box and packing, and include a full description of the problems involved. Also include your telephone number. You need not return accessory items unless directly related to the service problem.

Service note

Dear OM, if you desire to correspond on a technical or operational problem, please make your note short, complete, and to the point, and PLEASE make it readable.

Please list: Model and serial number.
The problem you are having.

Please give sufficient detail to diagnose. Information such as other equipment in the station, meter readings and anything else you feel might be useful in attempting diagnosis.

Caution

Do not pack the equipment in crushed newspapers for shipment. Extensive damage may result during shipment.

Notes

1. Record the date of purchase, serial number and dealer from whom purchased.
2. For your own information, retain a written record of any maintenance performed on the unit.
3. When claiming warranty service, please include a photocopy of the bill of sale, or other proof of purchase showing the date of sale must accompany the transceiver.

6-3. IN CASE OF DIFFICULTY

The problems described in this table are failures caused, in general, by improper operation or connection of the transceiver, not by defective components. Examine and check according to the following table.

Symptom	Probable cause	Corrective action
Indicators do not light and no receiver noise is heard when the POWER switch is turned on. All the indicators flash.	<ol style="list-style-type: none"> 1. Low voltage. 2. With optional DC cable: <ol style="list-style-type: none"> 1) Bad power cable or connections. 2) Blown power supply fuse. 	<ol style="list-style-type: none"> 1. Recharge/ replace the battery. 2. <ol style="list-style-type: none"> 1) Check cables and connections. 2) Check for the cause of the blown fuse and replace the fuse.
No sound from the speaker. No signal can be received.	<ol style="list-style-type: none"> 1. Squelch is closed. 2. With the TSU-7: CTCSS is operating. 3. DTSS is operating. 	<ol style="list-style-type: none"> 1. Turn the SQL control counter-clockwise. 2. Press the F key, then the 3/M.CT or 2/S.CT key to turn off the CTCSS. 3. Press the F key, then the 6/M.DT or 5/S.DT key to turn off the DTSS.
No control works.	<ol style="list-style-type: none"> 1. LOCK is ON. 2. T.ALT is ON. 3. During A.B.C. operation, being exchanging the bands each other. 	<ol style="list-style-type: none"> 1. Press the F key, then the ENT / LOCK key to turn off the LOCK. 2. Press the F key, then the 4 / T.ALT key. 3. See section 4-2-5 : A.B.C .
Memory channel cannot be recalled.	Nothing is stored in the memory channel.	See section 4-4-5 : Memory Entry
Memory cannot be backed up.	Backup battery voltage is low.	Contact the authorized dealer.

7. OPTIONAL ACCESSORIES

SWIVEL
MOUNT
BH-6



CTCSS UNIT
TSU-7

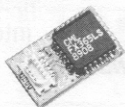

HEADSET with
VOX/PTT
HMC-2



SPEAKER
MICROPHONE
SMC-31



SPEAKER
MICROPHONE
SMC-32



REMOTE CONTROL
SPEAKER MICROPHONE
SMC-33



WATER
RESISTANT BAG
WR-1

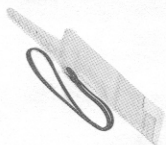

SOFTCASE
SC-28
for PB-5,6



SC-29
for PB-7,8,9



TELESCOPIC
ANTENNA
RA-3/5
144MHz /
144,440MHz

BOTTOM
COVER
BM-1



BATTERY CASE
AA x 6
BT-6



NiCd BATTERY PACK
7.2V 200mAh 7.2V 600mAh
PB-5 PB-6



7.2V 1100mAh
PB-7



12V 600mAh
PB-8



7.2V 600mAh
PB-10
(not for rapid
charger)



RECHARGEABLE
NiCd Battery Pack
PB-9
7.2V 600mAh
for
U.S.A.
version



For PB-10 only
MOBILE CHARGER
DC-4

MOBILE
CHARGER
DC-5
for PB-6/7/9



FILTERED CIGARETTE
LIGHTER CODE
PG-3F



PLUG CODE
PG-2W



BATTERY CHARGER
for PB-6/7 only
BC-9



RAPID CHARGER
BC-11



FOR PB-10 ONLY
WALL CHARGER
BC-12
CHARGING :
15HOUR
for general
market only



COMPACT
CHARGER
BC-10



FOR PB-10 ONLY
BATTERY CHARGER
BC-2
CHARGING 15HOUR
for U.S.A., Canada,
Europe, U.K.,
Oceania.

Some optional accessories may not be available in your area.

RECHARGING TIME

(Hours)

MODEL	PB-5	PB-6	PB-7	PB-8	PB-9	PB-10
Hight (mm)	36.5	55.5	98.5	84	98.5	55.5
Weight (g)	80	165	290	250	250	160
DC-5	NA	15	30	NA	15	NA
BC-10	8	8	15	8	8	15
BC-11	1	1	1	1	1	NA
BC-9	NA	15	30	NA	NA	NA

7-2. INSTALLING THE CTCSS UNIT TSU-7

NOTE ; BE SURE TO TURN THE POWER SWITCH OFF BEFORE REMOVING THE BATTERY CASE.

1. Attach the cushion supplied with the TSU-7 to the rear of the unit. Remove the backing from the other side of the cushion.
2. Remove the rubber cap on the DC IN, MIC, and SP sockets.
3. Remove the Battery Pack and remove the four philips head screws from the terminal plate of the transceiver. (Fig.1)
4. Remove the three screws holding the front and rear of the case together. (Fig.2)
5. Slightly lift the sides of the battery case at the front and rear, as shown in figure 3.
6. Lift up PC board A , and disconnect PC board B from it. (Fig.1)
7. Connect the TSU-7 to PC board A in place of PC board B.

8. When putting the case back together, make sure the PTT switch base (part C) fits in the groove (part D) in figure 3.
9. Secure the front and rear of the case with the screws.
10. Fit the end of the terminal plate into the release button hole and tighten the screws (Fig. 4).

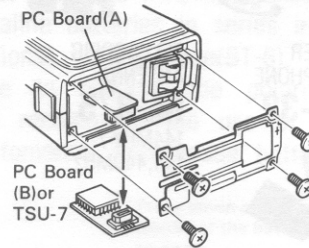

Fig 1.

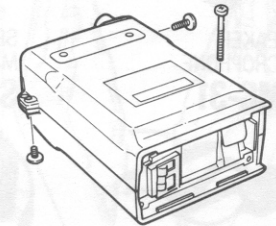

Fig 2.

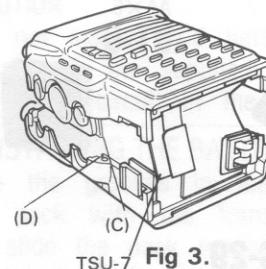

Fig 3.

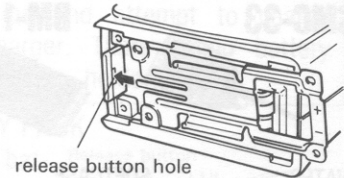

Fig 4.

7-3. OPERATION WITH REMOTE CONTROL SPEAKER MICROPHONE SMC-33

Notes

1. UP / DOWN will increment continuously if pressed for longer than 1 second.
2. The microphone switch is operational even when the F.LOCK switch on the main unit is turned ON.
3. Be sure to turn the POWER switch OFF when you plug in or remove the microphone.

Keys 1, 2, and 3 on the microphone are initially assigned to memory channels 1, 2, and 3, respectively. The functions of the keys on the transceiver can be set as follows:

1. Hold down transceiver key 1 (or 2 or 3) and turn the power on. The programmable function 1 (or 2 or 3) indicator appears for 10 seconds.

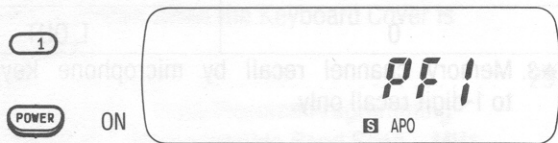

2. When you press a key on the transceiver, the function of that key is assigned to key 1 (or 2 or 3) on the SMC-33.

Example: When you press the CALL key, key 1 on the SMC-33 becomes the CALL key. When you press the F

key, then the CALL key, key 1 becomes the CALL SCAN key.

The keys that you can set for keys 1, 2, and 3 on the SMC-33 and their functions are listed on the next page.

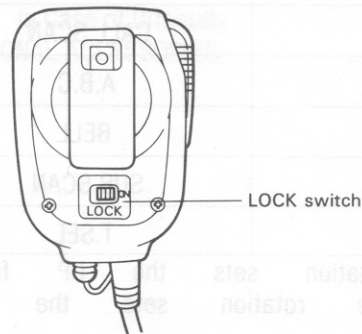
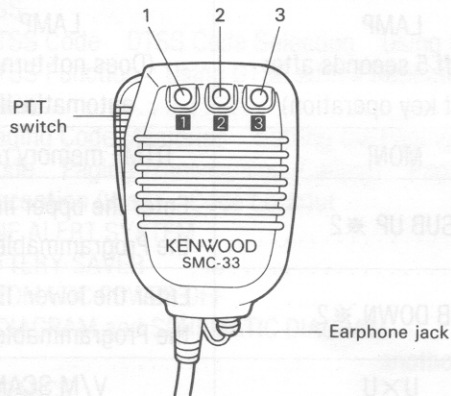

When the LOCK switch is turned ON the MR1, MR2, and MR3 keys on the front of the microphone are disabled.

Press the key below.	Press the F key, then key below.
Tuning control ※1	
LAMP (Turns off 5 seconds after the last key operation)	LAMP (Does not turn off automatically)
MONI	DTMF memory recall
SUB UP ※2	Enter the upper limit of the Programmable scan
SUB DOWN ※2	Enter the lower limit of the Programmable scan
U×U	V/M SCAN
CALL	CALL SCAN
BAND	A.B.C
MHz	BELL
SCAN	SUB SCAN
TONE	T.SEL

※1 Clockwise rotation sets the UP function, counterclockwise rotation sets the DWON function.

※2 Pressing the UP / DWN key for longer than 1 second changes frequency continuously.

Press the key below ※3	Press the F key, then key below.
DUAL	DUP
REV	SHIFT
1	AL
2	S.CTCSS
3	M.CTCSS
4	STEP
5	S.DTSS
6	M.DTSS
7	LOW
8	U CHG
9	DTSS.SEL
0	L.OUT

※3. Memory channel recall by microphone key is limited to 1-digit recall only.

The SMC-33 can be used with models that have no remote function. For these radios make sure that the LOCK switch on the back of the microphone is ON before use.

FCC WARNING

This equipment may generate or use radio frequency energy. Changes or modifications to this equipment may cause harmful interference, unless the modifications are expressly approved in the instruction manual. The user could lose the authority to operate this equipment if an unauthorized change or modification is made.

KENWOOD

CAUTION

Using fixed station operation on a mobile antenna may cause interference to nearby electronic equipment. If you are using a mobile antenna, use it only in the mobile mode. In fixed station operation, a low ground plane may cause a high SWR, which may lead to interference to nearby electronic equipment.

Press the
power
switch for
longer than
6.3 second
to turn the
transceiver
on or off.