



**2m FM  
HANDY TRANSCEIVER  
Model TR-2300**



**OPERATING MANUAL**

## INTRODUCTION

Your Model TR-2300 is a high-quality 2 m (144 MHz band) transceiver for use in amateur radio mobile stations as well as fixed stations.

It is small and light weight, and is equipped with PLL synthesizer control system for a wide coverage of 80 channels and one fixed channel. The type of wave is F3 and the transmit output is 1W.

### Note:

Save the packing box and materials in case the unit needs to be shipped for repair or mobile operation.

## CONTENTS

<b>ACCESSORIES</b> .....	2
<b>SPECIFICATIONS</b> .....	3
<b>SECTION 1. OPERATING PARTS AND THEIR FUNCTIONS</b> .....	4
<b>SECTION 2. PREPARATION FOR OPERATION</b> .....	6
BATTERY LOADING .....	6
VOLTAGE CHECK .....	6
COMPARISON BETWEEN MANGANESE BATTERY AND Ni-Cd BATTERY .....	7
BATTERY CHARGING .....	7
USE OF COAXIAL CABLE .....	7
<b>SECTION 3. INSTALLATIONS</b> .....	8
HAND-CARRIED OPERATION .....	8
MOBILE STATION OPERATION .....	8
FIXED STATION OPERATION .....	9
<b>SECTION 4. OPERATION</b> .....	10
TRANSCEIVE OPERATION .....	10
USE OF SQUELCH KNOB .....	10
USE OF AUX SWITCH .....	10
USE OF TONE SWITCH .....	10
USE OF 4-5-RPT SWITCH .....	11
REPEATER OPERATION .....	11
USE OF LAMP SWITCH .....	11
<b>SECTION 5. ADDITIONAL FREQUENCIES</b> .....	12
INSTALLATION OF ADDITIONAL FREQUENCIES .....	12
FREQUENCY ADJUSTMENT .....	12
<b>OPTIONAL PARTS</b> .....	13
<b>BLOCK DIAGRAM</b> .....	14
<b>SCHEMATIC DIAGRAM</b> .....	15

## ACCESSORIES

The following accessories are supplied with TR-2300:

(1) Dynamic microphone (with 4P plug) . . . . .	1	(8) Battery case A (for six batteries) . . . . .	1
(2) 1/4λ whip antenna (built-in) . . . . .	1	(9) Battery case B (for four batteries) . . . . .	1
(3) Dummy battery . . . . .	1	(10) Battery charger . . . . .	1
(4) External speaker plug . . . . .	1	(11) Hook . . . . .	1
(5) Soft case . . . . .	1	(12) Screw, 3φ . . . . .	2
(6) Shoulder strap . . . . .	1	(13) Instruction manual . . . . .	1
(7) Power plug with lead (external power cord) . .	1		

# SPECIFICATIONS

## GENERAL

<b>Semiconductor</b> .....	Transistors	24
	FETs	7
	ICs	7
	Diodes	33
<b>Frequency Range</b> .....	144.0 to 146.0 MHz	
<b>Operating Temperature</b> .....	-20°C to +50°C	
<b>Operating Voltage</b> .....	External:	DC 13.0 V
	Internal:	Ni-Cd battery (UM-3 type) x 10 UM-3 dry battery x 9
<b>Operating Voltage Range</b> .....	DC 9.6 ~ 16 V	
<b>Grounding</b> .....	Negative grounding	
<b>Antenna Impedance</b> .....	50 ohms	
<b>DC Current (at DC 13.0 V)</b> .....	Approx. 45 mA in receive with no input signal Less than 450 mA in transmit (1 W, 50 ohm load)	
<b>Dimensions</b> .....	122 (134) W x 51 (52) H x 175 (198) D mm Figure in ( ) include projections.	
<b>Weight</b> .....	Approx. 1.2 kg (with 10 Ni-Cd batteries)	

## TRANSMIT SECTION

<b>Frequency</b> .....	144 MHz band, 40 channels 145 MHz band, 40 channels AUX, 1 channel
<b>Type of Wave</b> .....	F3
<b>RF Output</b> .....	1 W
<b>Modulation</b> .....	Reactance modulation (variable reactance frequency modulation)
<b>Max. Frequency Deviation</b> .....	± 5 kHz
<b>Spurious Radiation</b> .....	Less than -60 dB (higher harmonic less than -50 dB)
<b>Microphone</b> .....	500 ohms, dynamic type, with press-to-talk switch

## RECEIVE SECTION

<b>Frequency</b> .....	144 MHz band, 40 channels 145 MHz band, 40 channels AUX, 1 channel
<b>Type of Wave</b> .....	F3
<b>Receive System</b> .....	Double superheterodyne
<b>Intermediate Frequency</b> .....	1st IF: 10.7 MHz 2nd IF: 455 kHz
<b>Sensitivity</b> .....	1μV for 30 dB S/N Less than 0.4μV for 20 dB noise suppression
<b>Squelch Sensitivity</b> .....	Less than 0.25μV
<b>Passband Width</b> .....	More than 14 kHz at 6 dB down
<b>Selectivity</b> .....	Less than 32 kHz at 60 dB down
<b>Audio Output</b> .....	More than 0.7 W across 8 ohm load (10% distortion)

**Note:** The circuit and ratings may change without notice due to development in technology.

## SECTION 1. OPERATING PARTS AND THEIR FUNCTIONS

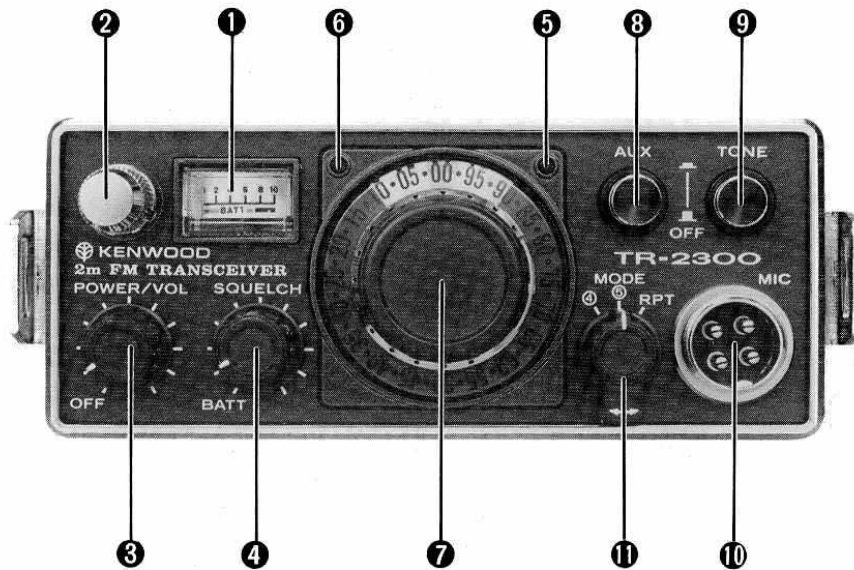

### 1 Meter

This meter indicates the strength of receiver input signal (S) and transmitter output signal (RF). It is also used as a power voltage checker. The indications of input and output signals are automatically switched when the unit is set in the transmit or receive mode. When checking the power voltage, set the SQU knob (4) to the BATT position.

### 2 Whip Antenna

When the unit is used as a portable rig, pull out the whip antenna to its full length. The whip antenna can be removed from the unit by unscrewing it to the left. If an external antenna is to be used, do not remove the whip antenna but retract it until it is fully stored in the unit.

### 3 POWER/VOL Knob

This knob has two functions; power ON/OFF and receiver volume control. To turn off the power, rotate the knob fully counterclockwise.

### 4 SQUELCH Knob

This knob has two functions; battery check and squelch control. To check the battery voltage, rotate the knob fully counterclockwise (BATT position).

For squelch adjustments, rotate the knob clockwise. The squelch will be ON at about the center position of the turning range.

### 5 AUX Lamp

This lamp (light emitting diode) will light when the AUX switch is set to ON (  ). The lamp goes off when the lamp switch (12) is set to OFF.

### 6 ON AIR Lamp

This lamp (light emitting diode) will light when the unit is set in transmit mode.

### 7 MAIN Knob (frequency selector switch)

This knob is used to select the desired channels. It turns either clockwise or counterclockwise. It has 40 channel steps. The knob is calibrated from 00 to 05, 10 . . . . . in 50 kHz increments ( $\times 10$  kHz). One step represents 25 kHz (see Table 1).

The knob has a large notch at the "00" position for quick reference during operation.

### 8 AUX Switch

This switch is used for fixed channel operation. When the switch is pressed (  ), the unit is set for fixed channel operation regardless of the position of the 4-5-RPT knob. By pressing the switch once again (  ), the unit is set to the frequency indicated on knobs.

(For the use of the AUX switch, refer to Section 4.)

### 9 TONE Switch

When this switch is pressed (  ), the repeater control tone signal (1750 Hz) circuit is activated and the unit is set in the transmit mode.



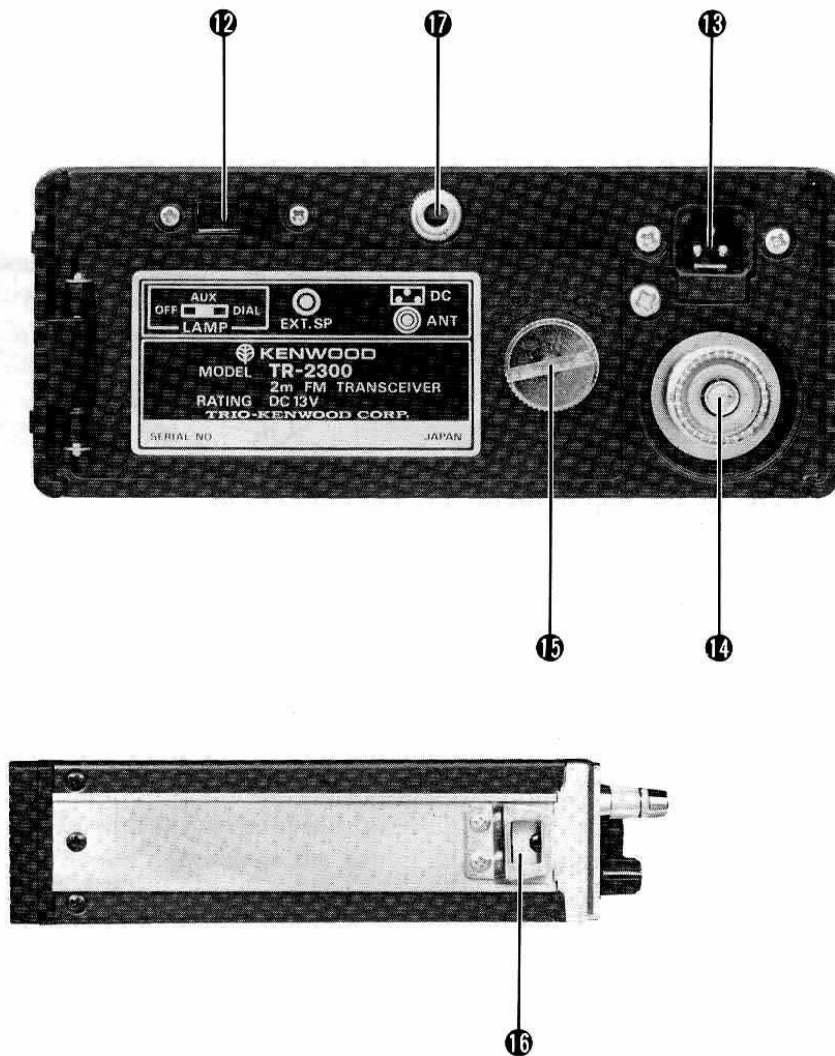

**10 MIC Connector**

Connect the accessory microphone to this connector. By pressing the microphone switch, the unit is set in the transmit mode.

**11 4-5-RPT Knob**

This switch is used for 144 MHz, 145 MHz band operation and repeater operation on 145 MHz band. At the RPT position, the main knob indicates a receive frequency. The transmit frequency is 600 kHz below the receive frequency. (For details, refer to Section 4.)

**12 LAMP Switch**

The lamp in the main knob and the AUX lamp will light when this switch is set to the DIAL (right) position. The AUX lamp will light at the AUX (center) position. In the OFF position, both lamps go off. (For details, refer to Section 4.)

**13 External Power/Charge Terminal**

Connect an external power supply (DC 13V) with the supplied power cable plug (DC cord) referring to Fig. 9. This terminal is also used to charge Ni-Cd batteries (see page 7).

**14 External Antenna Terminal**

An external antenna of 50-ohm impedance is connected to this terminal. For connection, use a UHF type connector.

**15 Battery Removing Screw**

To remove the battery, turn this screw using a coin.

**16 Shoulder Strap Hook**

Used to secure the supplied shoulder strap.

**17 Earphone/External Speaker Terminal**

For connection of an earphone or external speaker, use the supplied plug.

## SECTION 2. PREPARATION FOR OPERATION

Your TR-2300 is used as a hand-carried operation, fixed station operation or mobile station operation. Before using, prepare the unit to insure correct operation.

### BATTERY LOADING

To load batteries, proceed as follows.

- ① Turn the battery removing screw at the bottom of the case using a coin and open the lid of the battery case (Fig. 1).

- ② Load nine UM-3 batteries or alkaline batteries (1.5V per cell) and the supplied dummy battery into the battery case. The dummy battery may be inserted in any place in the case.

**Note:**

When loading, ascertain that the battery polarity is correct.

- ③ When Ni-Cd batteries (1.2V per cell) are to be used, load 10 batteries or accessory Ni-Cd Battery Pack "PB-15". Refer to the instructions on the lid of the battery case.

- ④ Close the lid of the battery case and lock the battery removing screw.

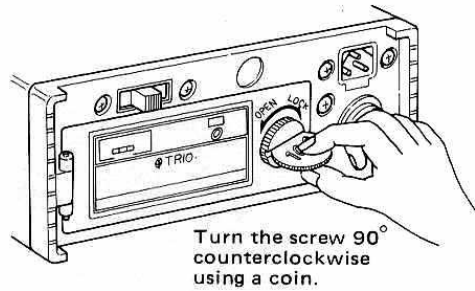

**Fig. 1 How to Open the Lid**

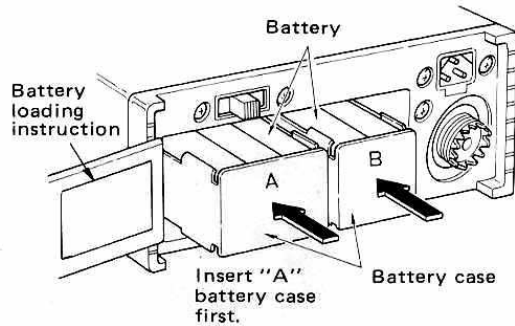

**Fig. 2 Battery Case**

### VOLTAGE CHECK

After the batteries have been loaded, check the battery voltage according to the procedure below.

- ① Set the SQUELCH knob to the BATT position by turning it fully counterclockwise.
- ② Turn the power switch (POWER/VOL) to ON.
- ③ When the meter indication is as shown in Fig. 4 (a), it means that the batteries are weak. Replace all the batteries. In the case of Ni-Cd batteries, recharge the batteries referring to page 7.

**Note:**

When external power supply is used, the meter indicates the voltage of the external power.

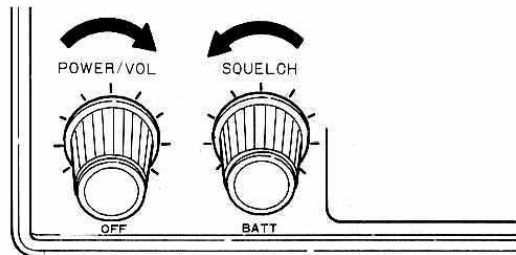

**Fig. 3**

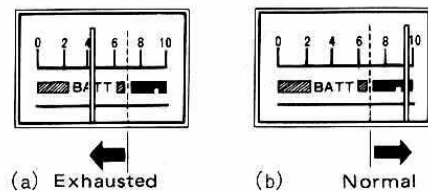

**Fig. 4 Voltage Check**

## COMPARISON BETWEEN MANGANESE BATTERY AND Ni-Cd BATTERY

When the voltage of Ni-Cd battery decreases to 1.0V or less, the energy of the battery is reduced to less than 1/10 of the initial value and, therefore, the battery must be charged. Fully charged battery will last for about 3 hours when used at the rate of 1 minute transmission and 3 minutes reception (squelch ON), while manganese batteries will last for about 1 hour. For this reason, it is advisable to use Ni-Cd batteries to insure more satisfactory performance of the unit and longer battery life.

## BATTERY CHARGING

- ① Check the battery voltage (see page 6) before charging. The battery should be recharged before the battery voltage is reduced to 9.6V (between red and black zones of meter).
- ② Before charging, be sure to turn the power switch (POWER/VOL) to OFF.
- ③ The unit is equipped with special terminals for charging Ni-Cd batteries. To charge the batteries, use the supplied battery charger as shown in Fig. 5. It takes about 15 hours until the batteries are fully charged.

### Notes:

1. When the batteries have been fully charged, do not attempt to continue charging. The batteries should be charged at temperatures of 0°C ~ 45°C.
2. Never try to charge normal type dry batteries or alkaline batteries, since they are not designed to be charged. If charged, a gas will be developed which causes explosion of the batteries, resulting in damage to the unit.

## USE OF COAXIAL CABLE

A coaxial cable should be used between the antenna and the transceiver. Since the coaxial cable is subject to loss in high frequency band such as a 144 MHz band, it must be of a low loss (thick) type, particularly for fixed station operation where a long cable is required. (Use the coaxial cable with 50 ohms).

The coaxial cable used in the antenna system should be less than 1.5 in SWR (standing wave ratio). Optimum SWR is obtained when the cable length is  $\lambda \times 0.67$  ( $\lambda$  : wave length, 0.67 : cable reduction ratio) times integral number.

Table 1 Types of Batteries

Manganese battery	Normal type 1.5V dry battery (non-rechargeable).
Alkaline battery	This type of battery uses caustic potash as electrolyte and is superior in performance to manganese battery. It is interchangeable with manganese battery (alkaline battery is non-rechargeable).
Ni-Cd battery	Nickel-cadmium (Ni-Cd) battery (rechargeable).

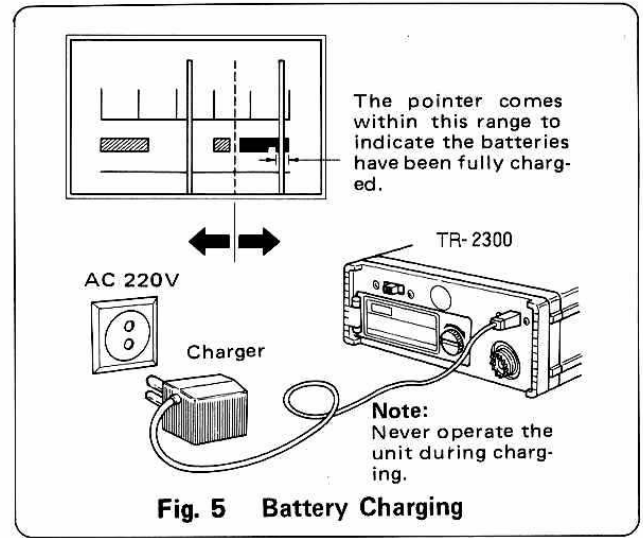
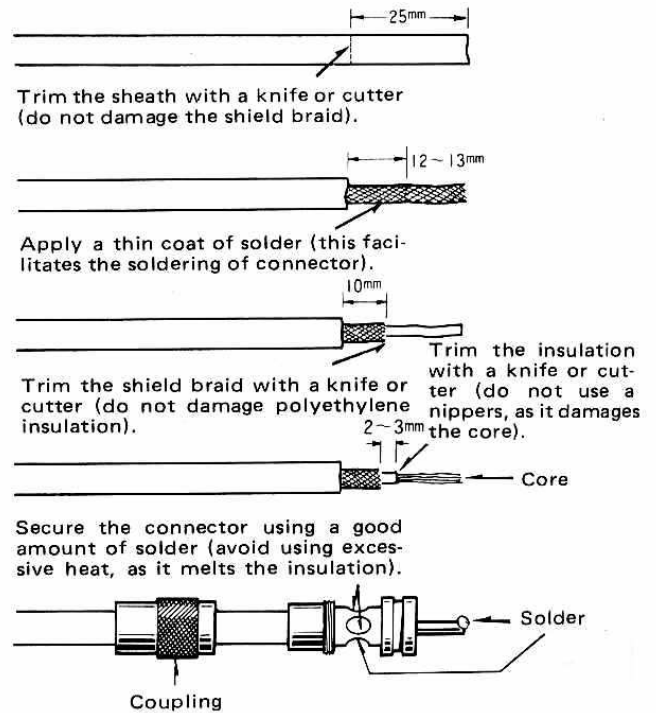

Fig. 5 Battery Charging



(First insert the cable into the coupling, making sure that the direction of the coupling is correct.)

Fig. 6 Mounting the UHF Type Connector

## SECTION 3. INSTALLATIONS

### HAND-CARRIED OPERATION

- ① Load the batteries (see "Battery Loading").
- ② Attach the supplied carrying strap as shown in Fig. 7.
- ③ Attach the hook as shown in Fig. 7.
- ④ Insert the connector of the supplied microphone into the microphone jack. The microphone may be hung on the hook.

**Note:**

When the unit is to be moved from one location to another with the antenna left extended, care should be taken not to damage the antenna.

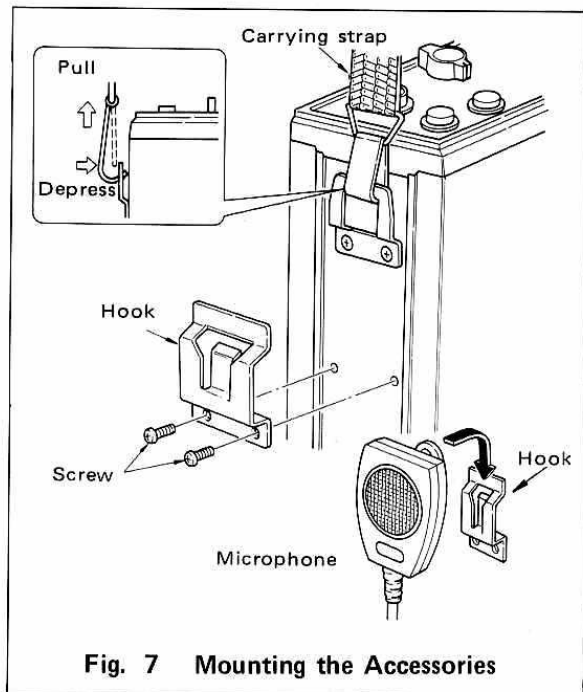

Fig. 7 Mounting the Accessories

### MOBILE STATION OPERATION

- ① For mobile station operation, the unit can be connected to a car battery (DC 13.8V) or accessory position on the fuse block. Make certain that the yellow lead is connected to the positive (+) post and the black lead to the negative (-) post. In this case, use a line filter between the unit and the battery to prevent noise generated from the power system. To supply the power from car battery, the unit may be connected to the cigarette lighter socket installed in the car (Fig. 8).

**Note:**

Be sure to use a fuse (1A) between car battery and the unit.

- ② Various types of car antennas are available from most radio shops. Install your car antenna correctly according to the instruction manual included with the antenna.

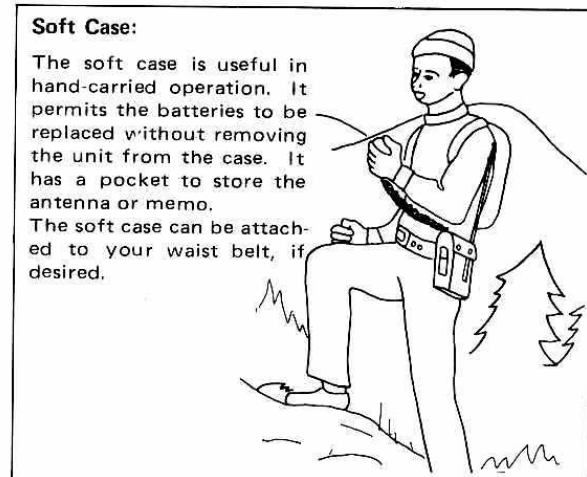

**Soft Case:**

The soft case is useful in hand-carried operation. It permits the batteries to be replaced without removing the unit from the case. It has a pocket to store the antenna or memo. The soft case can be attached to your waist belt, if desired.

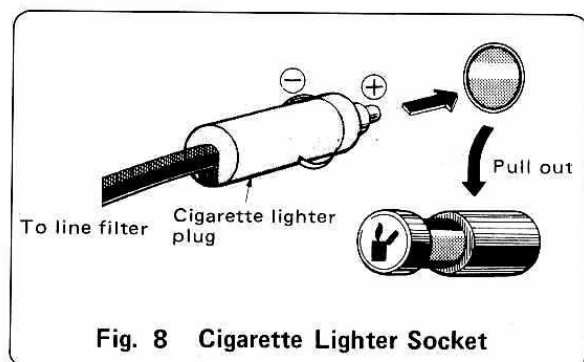

Fig. 8 Cigarette Lighter Socket



## FIXED STATION OPERATION

- ① For fixed station operation, it is recommended that an external power supply be employed, though internal batteries may also be used. The external power supply has an advantage of eliminating the need for checking the power voltage. When using the external power supply, connect it to the unit using the supplied power cord as shown in Fig. 9. The ratings of the external power supply should be DC 13V, 0.5 A or higher. (A fuse should be used in the DC output circuit.)

### Note:

Battery charger cannot be used as external power supply.

- ② When using an external antenna, connect it to the external antenna terminal at the rear. The whip antenna must be fully retracted into the unit. (See Fig. 6 for connection of the UHF type connector to the coaxial cable.)
- ③ For mounting the microphone hook, see Fig. 7.

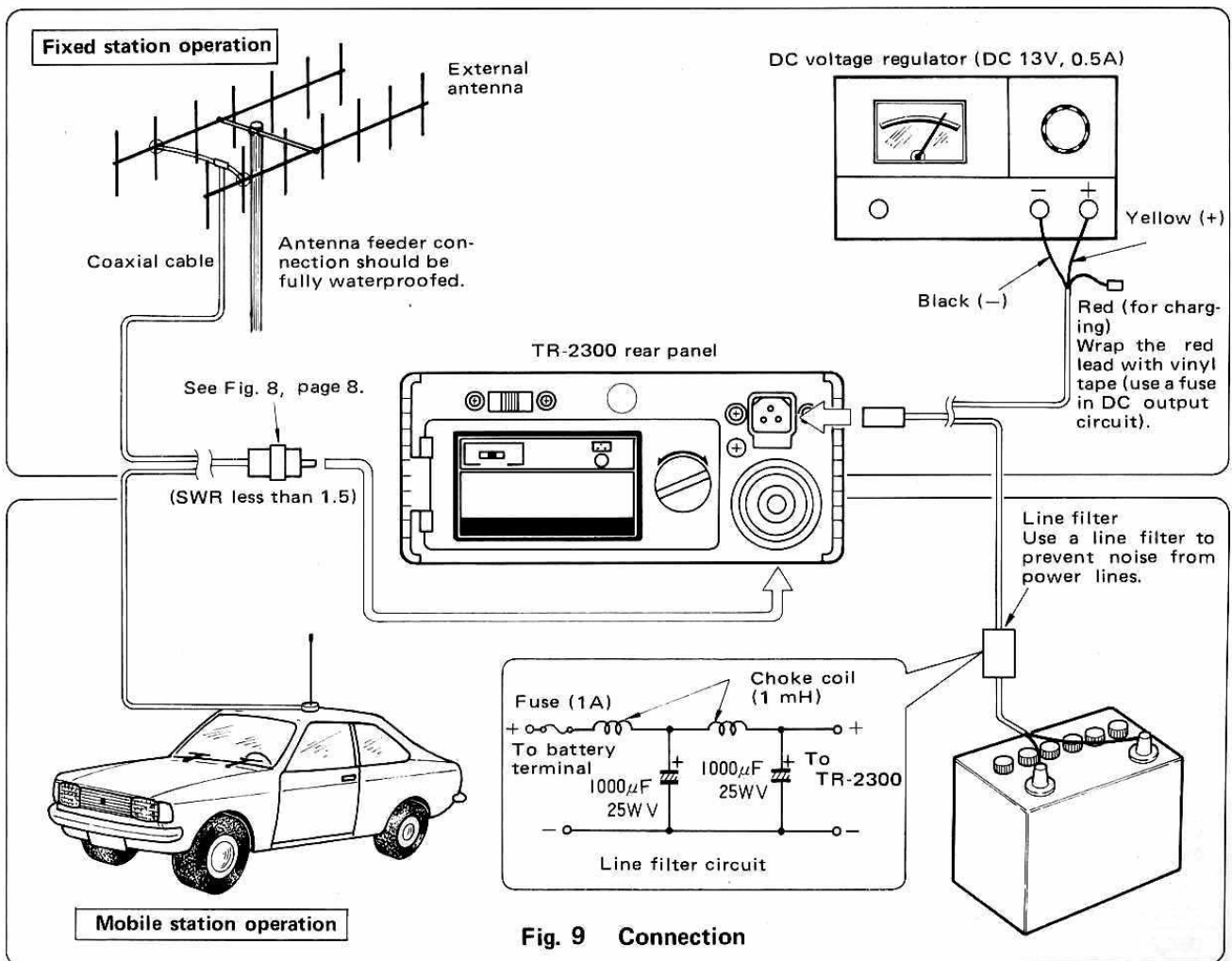

Fig. 9 Connection

## SECTION 4. OPERATION

### TRANSCIVE OPERATION

For transceive operation, use the following procedure:

- ① Check to make sure that the antenna (whip or external) and power supply (built-in or external) are properly connected.
- ② Turn POWER/VOL switch to ON.
- ③ Set the unit to the operating frequency using the 4-5-RPT knob and the main knob (see Table 2).
- ④ For operation, see Fig. 10 and Fig. 11.

### USE OF SQUELCH KNOB

To eliminate noise while signals are absent, slowly turn the SQUELCH knob clockwise until the speaker is quieted (threshold point). This adjustment should be made when signals are not received. When properly adjusted, the current drain during

standby mode is minimized (about 45 mA). This control does not affect the receiver volume when signals are present. Adjust the knob for optimum reception according to the strength of the signal being received.

### USE OF AUX SWITCH

When the AUX switch is set to ON (  ) the unit operates on the frequency of AUX channel regardless of the position of the main knob and 4-5-RPT switch. Use this switch for club channel or private channel operation. For additional frequencies, refer to Section 5.

### USE OF TONE SWITCH

This switch is used to transmit a TONE signal. Depress the switch and a signal modulated by TONE signal (1750 Hz) is transmitted to control the repeater station.

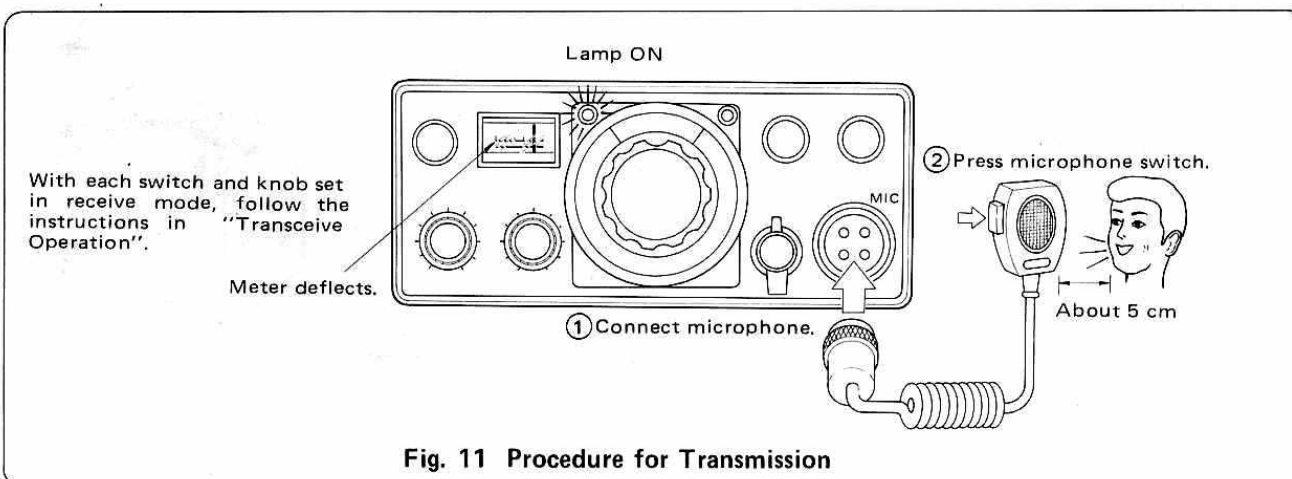
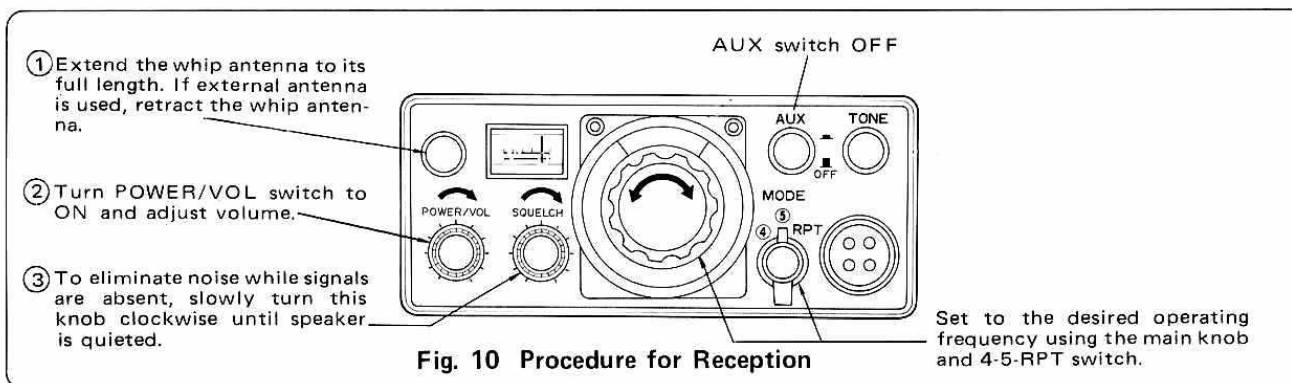

## USE OF 4-5-RPT SWITCH

4 – This position permits the unit to operate on any of 40 channels of 144.000 ~ 144.975 MHz at 25 kHz intervals (operating frequency is common to transmission and reception).

5 – This position permits the unit to operate on any of 40 channels of 145.000 ~ 145.975 MHz at 25 kHz intervals (operating frequency is common to transmission and reception).

RPT – This position permits the unit to operate on any of 40 channels in 145 MHz band. In this case, the transmit frequency is 600 kHz below the receive frequency.

### Notes:

Since the transceiver uses the PLL synthesizer, if it is in any of the following conditions, the PLL circuit is unlocked and the protective circuit is activated to stop the local oscillator signal to the transmitter and receiver, thus making the transceive operation impossible.

1. The unit is set in AUX mode with no crystal loaded in AUX channel.
2. The main knob is positioned between channel steps (40 CH).
3. The PLL circuit is defective.

## REPEATER OPERATION

For repeater operation, set the 4-5-RPT switch to the RPT position. In this case, the transmit frequency is 600 kHz below the receive frequency (see Table 2).

When TONE signal is used for repeater operation, depress the TONE switch and the repeater station is operated by the 1750 kHz modulation signal.

## USE OF LAMP SWITCH

This switch is used for indication of frequencies on the main knob or AUX channel. Use this switch as necessary to reduce the current drain during standby mode (squelch ON).





Setting of lamp switch	Lamp ON	Current drain during standby mode
OFF AUX DIAL 		About 45 mA (current drain is minimized)
OFF AUX DIAL 		About 52 mA (45 + 7)
OFF AUX DIAL 		About 85 mA (45 + 7 + 33)

Fig. 12

Table 2 Operating Frequencies

Step	Freq. indicated	Frequency (MHz)				
		4-5-RPT switch				
		4	5	RPT		
				Receive	Transmit	
1	00	144.000	145.000	145.000	144.400	
2	•	144.025	145.025	145.025	144.425	
3	05	144.050	145.050	145.050	144.450	
4	•	144.075	145.075	145.075	144.475	
5	10	144.100	145.100	145.100	144.500	
6	•	144.125	145.125	145.125	144.525	
7	15	144.150	145.150	145.150	144.550	
8	•	144.175	145.175	145.175	144.575	
9	20	144.200	145.200	145.200	144.600	
10	•	144.225	145.225	145.225	144.625	
11	25	144.250	145.250	145.250	144.650	
12	•	144.275	145.275	145.275	144.675	
13	30	144.300	145.300	145.300	144.700	
14	•	144.325	145.325	145.325	144.725	
15	35	144.350	145.350	145.350	144.750	
16	•	144.375	145.375	145.375	144.775	
17	40	144.400	145.400	145.400	144.800	
18	•	144.425	145.425	145.425	144.825	
19	45	144.450	145.450	145.450	144.850	
20	•	144.475	145.475	145.475	144.875	
21	50	144.500	145.500	145.500	144.900	
22	•	144.525	145.525	145.525	144.925	
23	55	144.550	145.550	145.550	144.950	
24	•	144.575	145.575	145.575	144.975	
25	60	144.600	145.600	145.600	145.000	
26	•	144.625	145.625	145.625	145.025	
27	65	144.650	145.650	145.650	145.050	
28	•	144.675	145.675	145.675	145.075	
27	70	144.700	145.700	145.700	145.100	
30	•	144.725	145.725	145.725	145.125	
31	75	144.750	145.750	145.750	145.150	
32	•	144.775	145.775	145.775	145.175	
33	80	144.800	145.800	145.800	145.200	
34	•	144.825	145.825	145.825	145.225	
35	85	144.850	145.850	145.850	145.250	
36	•	144.875	145.875	145.875	145.275	
37	90	144.900	145.900	145.900	145.300	
38	•	144.925	145.925	145.925	145.325	
39	95	144.950	145.950	145.950	145.350	
40	•	144.975	145.975	145.975	145.375	
Fixed channel	AUX					

Enter additional frequencies for future reference. →

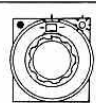
## SECTION 5. ADDITIONAL FREQUENCIES

When additional frequencies and adjustments are required, the following points should be observed. Additional frequencies can be selected from the amateur band covering 144.00 ~ 146.00 MHz.

### INSTALLATION OF ADDITIONAL FREQUENCIES

To install AUX CH frequencies (installation of crystal elements), use the following procedure.

#### 1. Removal of Case

Remove the 4 screws (2 on bottom and 2 on side) from the lower case of the unit (removal of upper case is not required).

#### 2. Crystal Element Oscillation Frequency

For operation on the desired frequency, the crystal element oscillation frequency can be obtained from the following equation.

$$f_o = \frac{f - 13.9}{3} \quad (\text{MHz})$$

$f$  = Desired frequency (MHz)

$f_o$  = Oscillation frequency (MHz)

#### (Example)

For operation on  $f = 145.75$  MHz:

$$f_o = \frac{145.75 - 13.9}{3} = 43.95 \text{ (MHz)}$$

Therefore, a 43.95 MHz crystal element should be inserted to the appropriate crystal socket (Fig. 13).

The crystal element used should be of the HC-25/u type (3rd over-tone).

The oscillating circuit is shown in the schematic diagram on page 15.

### FREQUENCY ADJUSTMENT

The frequency of any additional channel must be adjusted correctly after the crystal element have been installed. For accurate adjustments, the use of a frequency counter is recommended.

#### 1. Adjusting with Frequency Counter

For proper adjustments, refer to Fig. 13.

Requirements

- \* External power supply (internal batteries may be used)
- \* Frequency counter (capable of measuring up to about 150 MHz)
- \* Insulated screwdriver

Connect the frequency counter to the RX synthesizer unit (X55-1220-61) at the LR terminal on the bottom of the unit.

Set the AUX switch to ON (  ).

Install a crystal element and turn the trimmer TC3 so that the frequency counter indicates the frequency of  $f - 10.7$  (MHz).

#### 2. When Frequency Counter is not Available.

With the unit set to the receive frequency of your party's station, have the party receive your transmit signal.

Adjust the trimmer (TC3) so that the signal can be heard most clearly (or the center meter of the party's station indicates about "0" point).

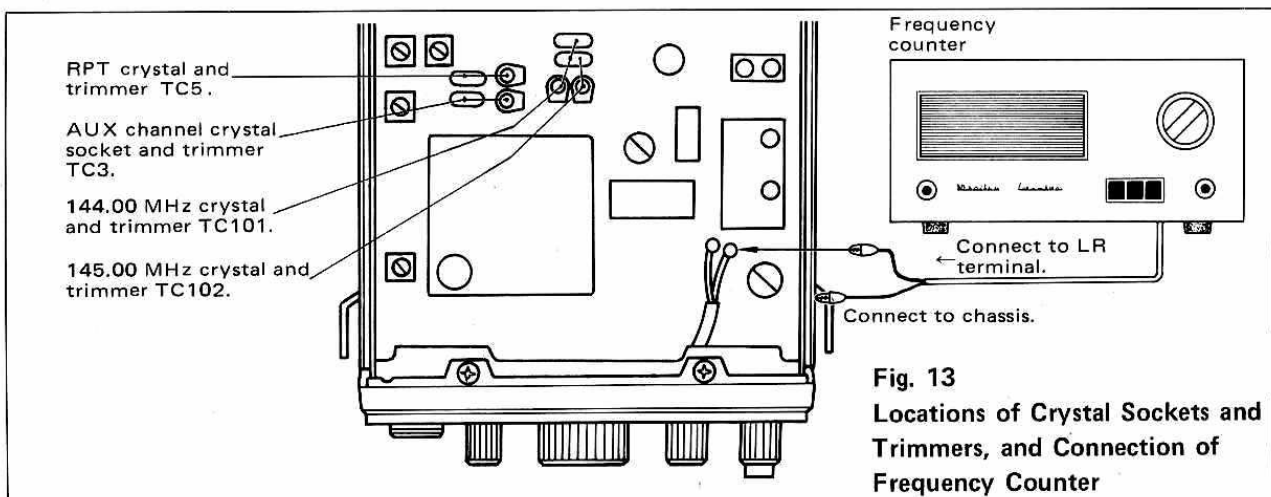

**Fig. 13**  
Locations of Crystal Sockets and Trimmers, and Connection of Frequency Counter



## OPTIONAL PARTS

The following accessories are available as options for more efficient use of your TR-2300.

### 1 Ni-Cd Battery Pack PB-15

The Ni-Cd battery pack PB-15 can be charged more than 300 times for economical operation of TR-2300.

### 2 Helical Antenna RA-1

The  $1/4\lambda$  helical antenna is best suited for mobile station operation.

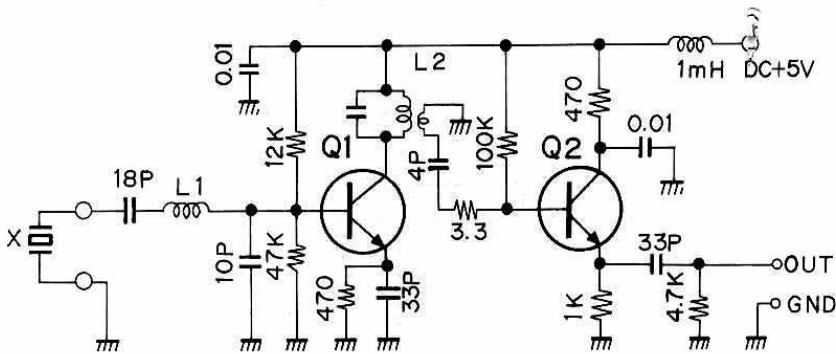

Fig. 14 Crystal Oscillation Circuit

L1: L33-0605-05  
L2: L32-0607-05 Q1, Q2: 2SC460(B)

#### Crystal Specifications

1. Type of holder: HC-25/u
2. Multiplication: 3rd over tone
3. Frequency tolerance: +0.002%, -0.001% at normal temperature.

MEMO

# BLOCK DIAGRAM

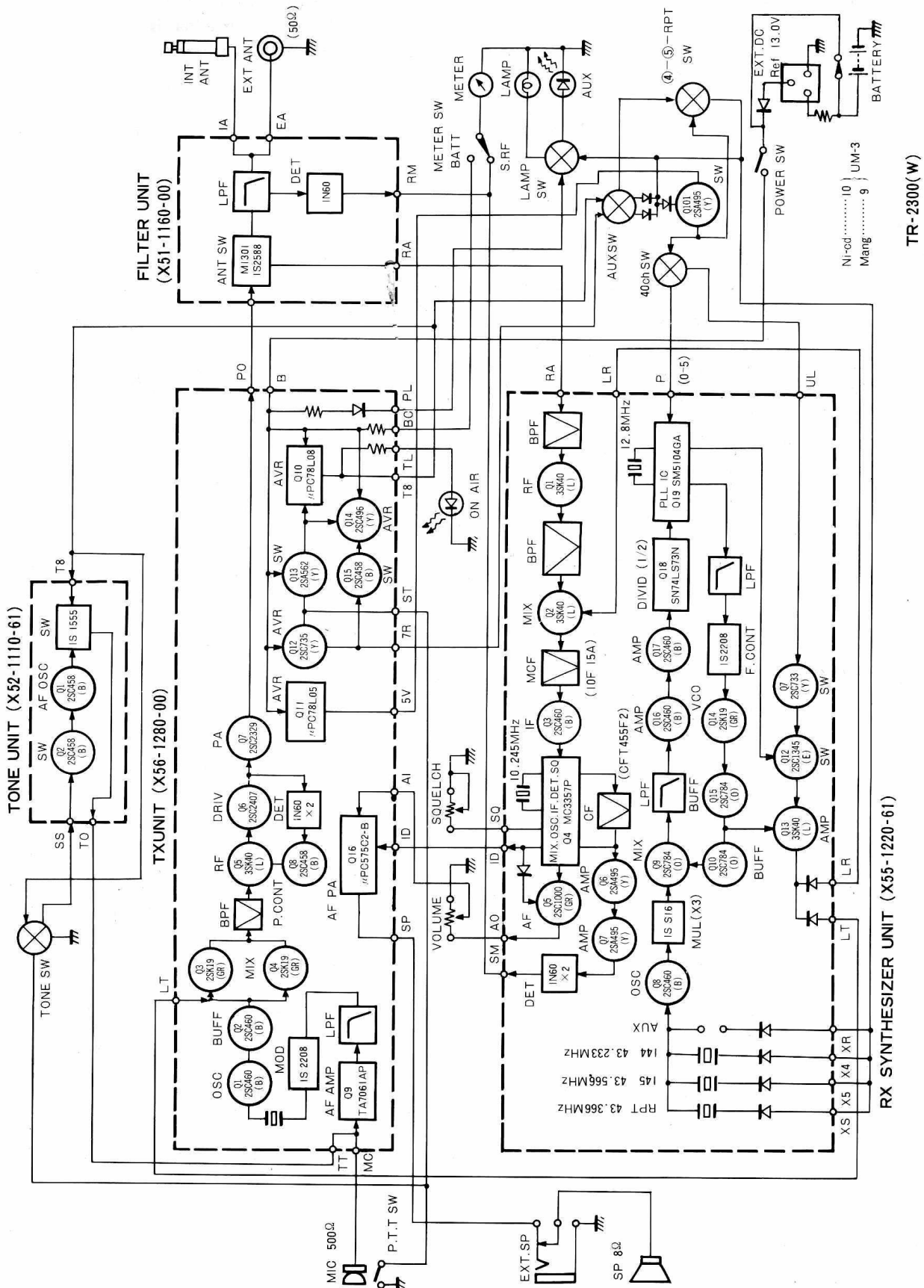

NI-od ..... 10 } UM-3  
Mang ..... 9

TR-2300(W)

RX SYNTHESIZER UNIT (X55-1220-61)



---

A product of  
**TRIO-KENWOOD CORPORATION**  
6-17, 3-chome, Aobadai, Meguro-ku, Tokyo 153, Japan

---

**TRIO-KENWOOD COMMUNICATIONS, INC.**  
1111 West Walnut Street Compton California 90220, U.S.A.  
**TRIO-KENWOOD COMMUNICATIONS, GmbH**  
D 6374 Steinbach TS Industriestrasse 8A West Germany  
**TRIO-KENWOOD(AUSTRALIA)PTY. LTD.**  
30 Whiting Street Artarmon Sydney N.S.W. Australia 2064