



**2m FM
SYNTHESIZED
HAND-HELD TRANSCEIVER
Model TR-2400**



INSTRUCTION MANUAL

INTRODUCTION

You are the owner of our newest product, the TR-2400 Transceiver. Please read this instruction manual carefully before placing your transceiver in service.

The unit has been carefully engineered and manufactured to rigid quality standards, and should give you satisfactory and dependable operation for many years.

AFTER UNPACKING;

Save the boxes and packing material in the event your unit needs to be transported for remote operation, maintenance, or service.

The following explicit definitions apply in this manual:

NOTE: If disregarded, inconvenience only, no risk of equipment damage or personal injury.

CAUTION: Equipment damage may occur, but not personal injury.

CAUTION: DO NOT CONNECT AN EXTERNAL DC-SUPPLY DIRECTLY TO THE CHARGE TERMINAL. Use only the supplied charger unit, optional base stand ST-1, or DC charger unit BC-5. Extensive damage will occur if this is disregarded.

CAUTION: DO NOT ATTEMPT TO MODIFY OR OTHERWISE TOUCH CMOS LSI CIRCUITS. Leave all service to a qualified, experienced technician.

CONTENTS

SPECIFICATIONS	3
FEATURES	4
Section 1 PREPARATION FOR USE	4
Accessories	4
Charging the battery	4
Section 2 CONTROLS AND TERMINALS	6
Top panel,	6
Front panel	7
Side panel	8
Section 3 KEY BOARD OPERATION	9
Channel selection	9
Shifting frequency	9
Memorizing frequency	10
Readout of memorized frequency	10
Scanning the memory channel	11
Touch tone keys	11
Section 4 OPERATION	11
Reception	11
Transmission	11
TX-OFFSET switch	11
S-TONE switch	12
Section 5 ADDITIONAL INFORMATION	13
General information	13
Ordering spare parts	13
Service	13
Optimal accessories	13
BLOCK DIAGRAM	14
SCHEMATIC DIAGRAM	15

SPECIFICATIONS

GENERAL

Semiconductors	Transistors	28
	FET	1
	ICs	18
	Diodes	52
Display	LCD (Liquid Crystal Display)	
Frequency Range	144.00 to 147.995 MHz	
Frequency Synthesizer	Digital control of phase locked VCO	
Synthesizer Stability	Less than $\pm 750\text{Hz}$ at 25°C	
Mode	FM	
Channels	800	
Memory Channels	10	
Operating Temperature	-20 to $+50^{\circ}\text{C}$	
Power Voltage	$9.6\text{VDC} \pm 15\%$	
Grounding	Negative grounding	
Antenna Impedance	50Ω	
DC Current	Approx. 28 mA in receive with no input signal Approx. 500 mA in transmit (at 1.5 W RF output) Approx. 0.8 mA in memory backup with power switch off	
Dimensions	71 mm (2-13/16") wide 192 mm (7-9/16") high 47 mm (1-7/8") deep	
Weight	740 gr (1.62 lbs.)	

TRANSMITTER SECTION

RF Output Power	1.5 Watts
Modulation	Variable reactance direct shift
Max. Frequency Deviation	$\pm 5\text{kHz}$
Spurious Radiation	Less than -60dB
Microphone	Condensor microphone

RECEIVER SECTION

Circuitry	Double superheterodyne
Intermediate Frequency	1st IF.....10.7 MHz 2nd IF.....455 kHz
Sensitivity	Less than $0.2\mu\text{V}$ for 12 dB SINAD (Less than $1\mu\text{V}$ for 30 dB S/N)
Squelch Sensitivity	Less than $0.25\mu\text{V}$
Pass Band Width	More than 12 kHz at 6 dB down
Audio Output	More than 200 m watts across 8Ω load (10% distortion)

NOTE: Circuit and ratings may change without notice due to developments in technology.

Section 1 PREPARATION FOR USE

FEATURES

- LCD digital readout
 - Readable in direct sunlight (better than LEDs)
 - Readable in the dark (with lamp switch)
 - Virtually no current drain (much less than LEDs) and display stays on
 - Shows receive and transmit frequencies and memory channel
- 10 Memories (always retained with battery backup)
- Automatic memory scanning (for "busy" or "open" channels)
- Mode switch for the following operations:
 - Simplex
 - Standard repeater by offsetting the transmit frequency +600 kHz or -600 kHz
 - Repeater with nonstandard splits by offsetting the transmit frequency to any frequency stored in memory O
- REVERSE momentary switch for the following applications
 - Checking signals on the input of a repeater
 - Determining if a repeater is "upside down"
- Built-in Touch-Tone generator using 16-button keyboard
- Keyboard selection of 5-kHz channels from 144.000 to 147.995 MHz
- UP/DOWN manual scanning and operation from 143.900 to 148.495 MHz in single or fast continuous 5-kHz steps. Even operates on MARS repeaters within this range by using memory O for transmit offset frequency
- LCD "arrow" indicators
 - ON AIR
 - Memory recall
 - Battery status
 - Lamp switch on
- Two lock switches to prevent accidental frequency change and accidental transmission
- Subtone switch (subtone module not Kenwood supplied)
- BNC antenna connector
- 1.5 watts RF output

ACCESSORIES

Carefully unpack your TR-2400 transceiver and check that it is supplied with the following accessories:

- (1) Rubber flex antenna (with BNC connector) 1 piece
- (2) Nickel-Cadmium battery pack 1 piece
- (3) AC charger 1 piece
- (4) Earphone 1 piece
- (5) External microphone plug 1 piece
- (6) External STAND-BY plug 1 piece
- (7) Instruction manual 1 copy

BATTERY

The supplied battery pack is fully charged in the factory.

Recharge it, however, before use for about 10 hours after loading, because there might be the case that it is naturally discharged.

1. BATTERY LOADING

To load batteries, proceed: (Fig. 1-1, 1-2)
Use a coin to turn the slotted screw at the bottom of the battery case. The battery case lid will slide down and off.

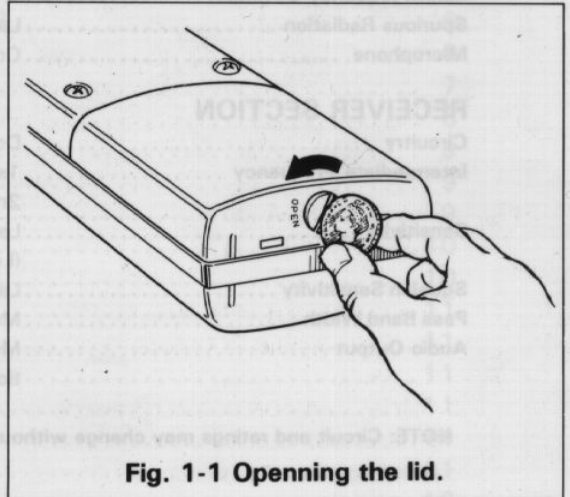

Fig. 1-1 Opening the lid.

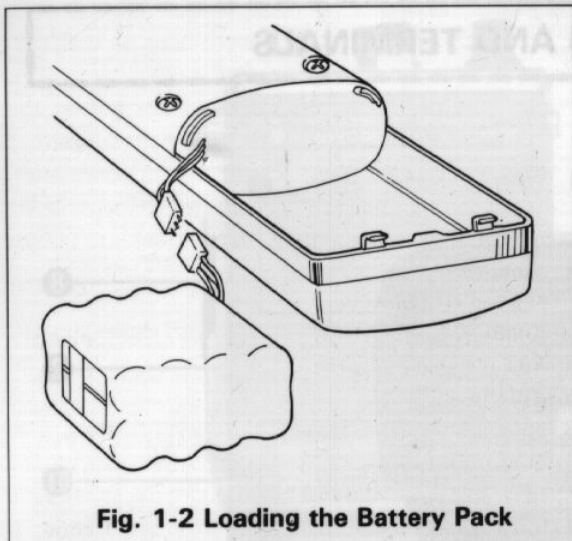

Fig. 1-2 Loading the Battery Pack

CAUTION 1: When loading the battery pack, handle the leads and connectors carefully. Make certain not to pinch the battery leads in the case.

CAUTION 2: Do not attempt to open the case on the keyboard side, as it can damage the ICs.

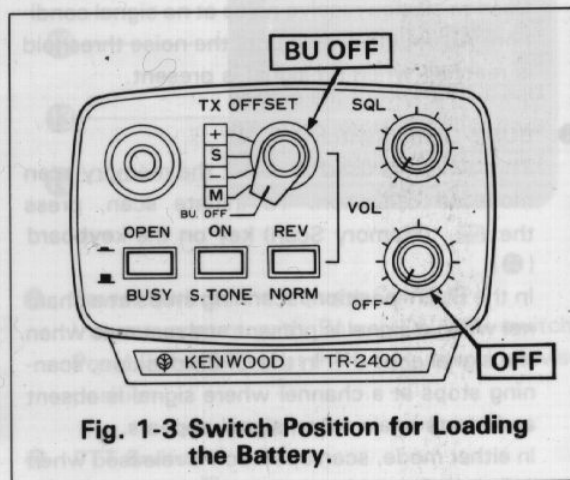



Fig. 1-3 Switch Position for Loading the Battery.

NOTE: Before loading batteries, turn the power switch OFF and the TX-OFFSET switch to B.U. OFF. Do not set the TX-OFFSET switch from B.U. OFF to another position when the power switch is in the OFF position. Failure to observe this precaution can result in incorrect indication on the LCD display. If this occurs, after turning the power switch ON, press the  key; the display will indicate 5.000.

2. CHARGING

When the battery check indicator (▶ BATT) in the LCD display lights, the battery should be charged using the supplied AC charger. The battery may be charged using a MODEL BC-5, DC-DC quick charger or MODEL ST-1 base stand available as an optional accessory.

The battery fully charged will last for about 2 hours and 30 minutes when used at the rate of 1 minute transmission and 3 minutes reception (squelch ON).

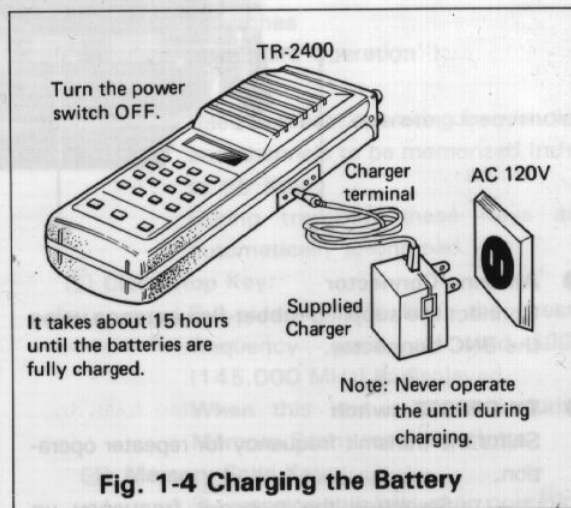

Fig. 1-4 Charging the Battery

CAUTION: This is a Charge terminal only. Do not direct wire this terminal to an external power supply.

NOTE 1: The battery indicator will light momentarily when the power switch is turned off. This is not an indication that the battery is low.

NOTE 2: When the batteries have been fully charged, do not attempt to continue charging. The batteries should be charged at temperatures of 0°C ~ 45°C.

3. BATTERIES REPLACEMENT

The TR-2400 is supplied with rechargeable nickel-cadmium batteries and AC charger, eliminating the need for battery replacement. However, if it should become necessary to replace the batteries, refer to 1. BATTERY LOADING.

Section 2 CONTROLS AND TERMINALS

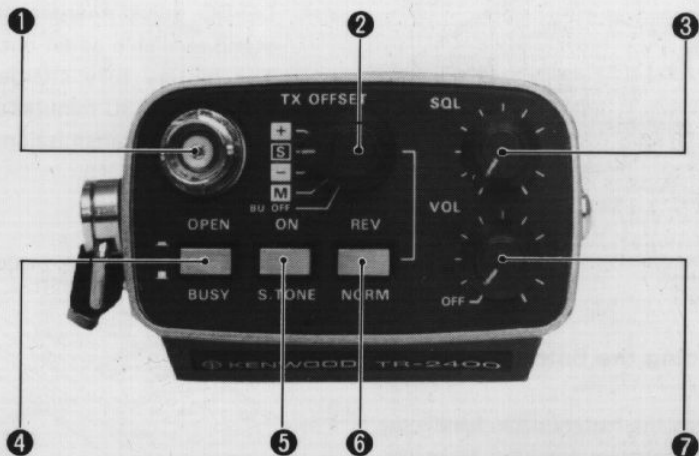

1 Antenna Connector

Connect the supplied rubber-flex antenna using the BNC connector.

2 TX-OFFSET switch

Shifts the transmit frequency for repeater operation.

“+”: Switches the transmit frequency up 600 kHz from the receive frequency.

“S”: Simplex (receive and transmit frequencies are the same).

“-”: Switches the transmit frequency down 600 kHz from the receive frequency.

“M”: The transmitter operates on a preset frequency in MEMORY channel O, while the receiver frequency doesn't shift.

Any frequency can be preset in the channel O for repeater operation.

“B.U. OFF”: When the power switch OFF, this position removes back up power from the memories (All memories go off). When the power switch ON, the transceiver will operate simplex mode only in this position.

When the transceiver is not to be used for a long period of time, set the switch to this position so that memory backup power is not consumed.

NOTE 1: Do not set the switch from BU OFF to another position when the power switch is in the OFF position.

NOTE 2: Failure to observe this precaution can result in incorrect display. To correct, turn the power

switch ON and reset by pressing the  key. The display will read 5.000.

3 SQL Control

Used to silence receive noise at no signal condition. Adjust clockwise until the noise threshold is reached when no signal is present.

4 BUSY-OPEN Switch

This switch is used to select the memory scan mode of operation. To initiate scan, press the  (Memory Scan) key on the keyboard (1).

In the BUSY position, scanning stops at a channel when a signal is present and resumes when the signal goes off. In the OPEN position, scanning stops at a channel where signal is absent and starts again when signal appears.

In either mode, scan operation is released when a signal is transmitted or the  key is pressed. If you desire to continue an interrupted without releasing the scan operation, press this switch twice to skip the unwanted channel.

5 S-TONE Switch

Sub-tone switch for control of a user supplied tone generator (Not available from TRIO-KENWOOD).

6 NORM-REV Switch

This switch is used to interchange transmit and receive frequencies for repeater operation, and to check the repeater input before switching to simplex operation.

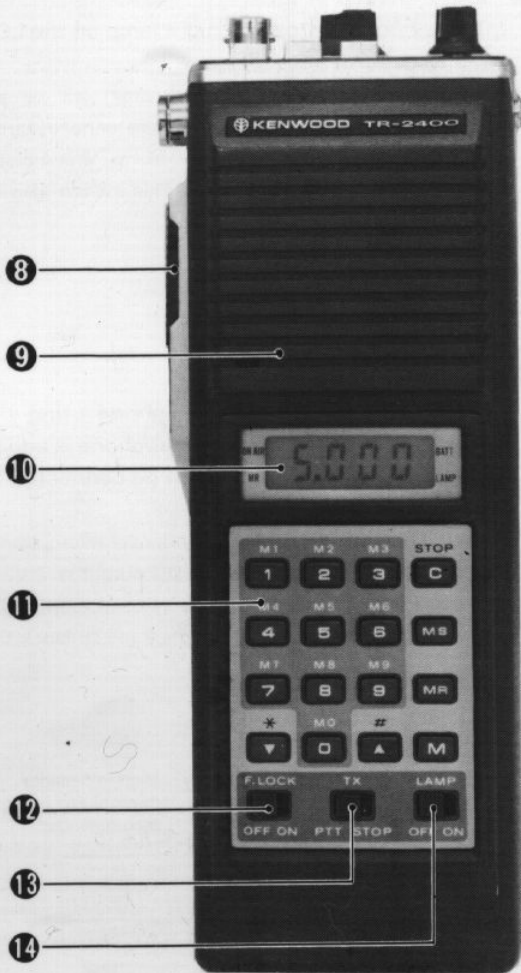

7 Power Switch and Volume Control
Volume control with Power ON/OFF switch. Power is turned off at the full counterclockwise position.

8 PTT Switch
For transmission, press this switch and speak into the microphone **9**.

9 Microphone
Miniature, high sensitivity condenser microphone.

10 LCD (liquid crystal Display) Panel
Displays frequency in 4 digits (for example, 146.940 MHz is displayed as **6940**). The night lamp is controlled by the LAMP switch **13**.
Annunciators to indicate transmit mode, memory output and battery wear are also provided on the LCD panel.

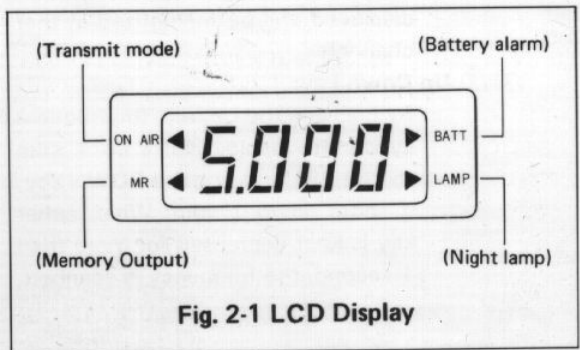

11 Key Board Switches
(refer to "Key Board Operation"):

1 ~ 0 Set Key:
Used to preset operating frequencies and channels to be memorized (refer to **M** Key).
During transmit, these Keys are automatically a tone pad.



STOP C Clear/Stop Key:
By pressing this key, the preset frequency goes off and **5000** (145.000 MHz) is displayed. When this key is pressed during Memory Scan, scanning stops.

MS Memory Scan Key:
By pressing this key, scan operation starts from memory channel 1 at a speed of 1 channel per second. The scan is repeated between channel 1 and 0, and stops when the **STOP C** key is pressed.
Scan operation is released when a signal is transmitted.

MR Memory Recall Key:
Press this key, then any Set Key (**1** - **0**).
The preset frequency will display. When the TX-OFFSET Switch is placed in the "M" position, the frequency memorized in channel "0" is transmitted simply by pressing the PTT switch (refer to Section 3 "KEY BOARD OPERATION").
With the **MR** key pressed, MR ◀ appears on the display. In the case of no entered frequency, the display will indicate **5000** (145.000 MHz). The memory output lamp MR ◀ is OFF during transmission.

M Memory Key:
Press this key, then press any Set Key (**1** - **0**). The frequency

displayed will be memorized in that channel.

  **Up Down key:**

By pressing the UP key, the frequency on the display shifts up 1 step (5 kHz). By pressing the DOWN key, it shifts down 1 step. When either key is kept depressed for more than 1 second, the frequency is scanned.

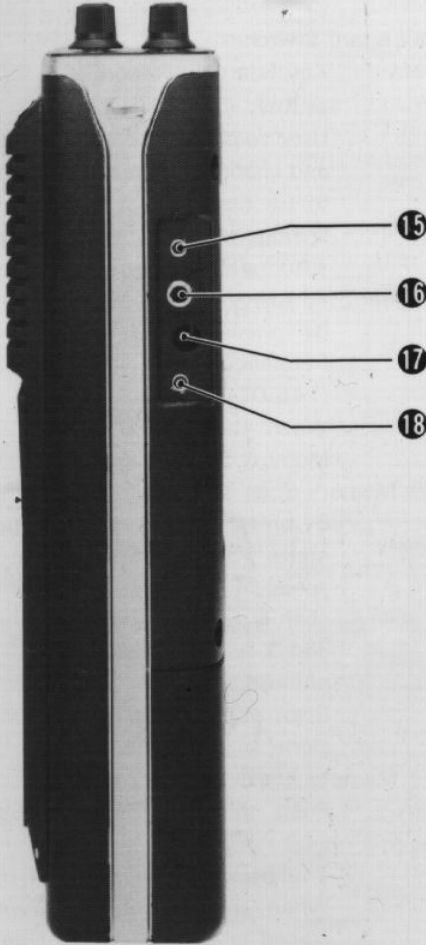

12 F-lock Switch

Place this switch ON and the displayed frequency will remain unchanged by keyboard operation.

This feature is convenient when carrying the transceiver.

13 TX Switch

Place this switch to STOP and the transceiver will not transmit. Use this feature when carrying the transceiver.

14 LAMP Switch

This switch controls the night lamp on the LCD panel.

NOTE: At LAMP switch ON battery drain will be accelerated. Do not use this feature unnecessarily. Always check the battery alarm annunciator (▶LAMP) on the LCD panel. This switch also indicates RED at ON.

15 Standby Jack

See MIC Jack (16)

16 MIC Jack

Connect your external microphone using the supplied MIC plug. If your microphone is equipped with a PTT switch, it can be connected to the Standby Jack.

NOTE: For direct connection of a condenser microphone. Input impedance is 2 kΩ and DC output is 7 V. When a dynamic microphone is used, connect it through a capacitor (0.47 μF ~ 1 μF) to block DC voltage.

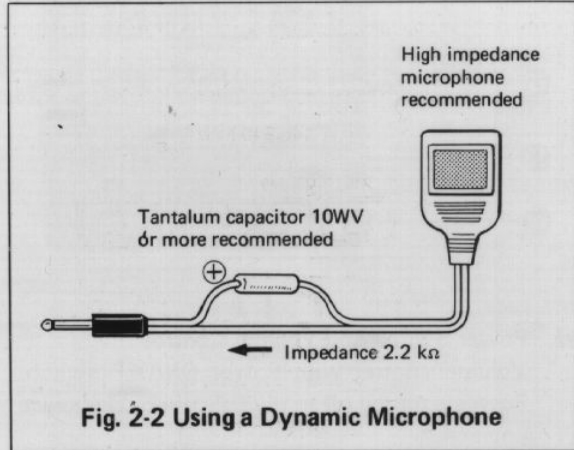

Fig. 2-2 Using a Dynamic Microphone

17 Charge Terminal

Used for charging the built-in nickel-cadmium battery. Connect the supplied AC charger. A Model BC-5 DC-DC quick charger (option) or Model ST-1 base stand (option) may also be connected.

CAUTION: This is a charge terminal only. Do not direct wire this terminal to an external D.C. supply.

18 EAR Jack

Connect an earphone or external speaker.

Section 3 KEY BOARD OPERATION

The TR-2400 employs a 16-key channel selection system. These instructions cover the basic operation of the key board.

It is also advisable to refer to Section 4 "OPERATION".

CHANNEL SELECTION

Frequencies are entered in 4 digits, so 4 Set keys should be used. For example, when entering 146.940 MHz, press keys **6** **9** **4** and **0** in that order. Since operation is in the Amateur band, the first key to be pressed should be **4** **5** **6** or **7** (frequencies cannot be set if any other key is pressed first).

When the power switch is turned on, the display indicates 5000 (145.000 MHz).

If the key setting is found to be incorrect after pressing 4 keys, press the correct keys once again. To correct the setting before all the 4 keys are pressed, press the **STOP** key and then press the correct Set keys.

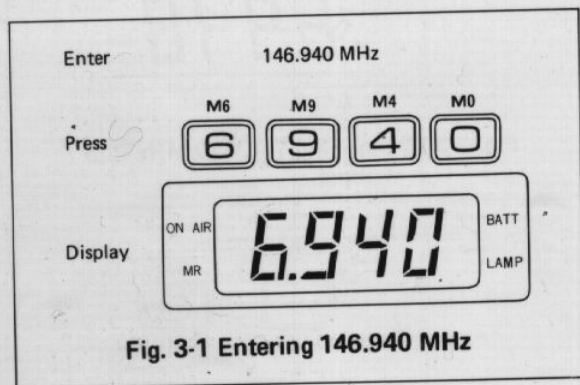

NOTE: If a new frequency is not completely entered, the transceiver will continue to operate on the previously retained frequency. Be certain to enter all 4 digits for a new frequency.

SHIFTING FREQUENCY

To shift frequency, proceed:

Press the Set keys as outlined previously, or press the **▼** or **▲** key.

The frequency shifts up or down by 5 kHz at each press of the **▼** or **▲** key; frequency is scanned when either key is kept depressed for more than 1 second. The scan is repeated between the 143.900 MHz and 148.495 MHz.

To operate above or below the band (to 148.495 MHz, from 143.900 MHz) use the Shift keys to manually scan beyond the band edge.

NOTE: The 143.900 to 143.995 and 148.000 to 148.495 MHz range are available only by operating the **▼** / **▲** keys.

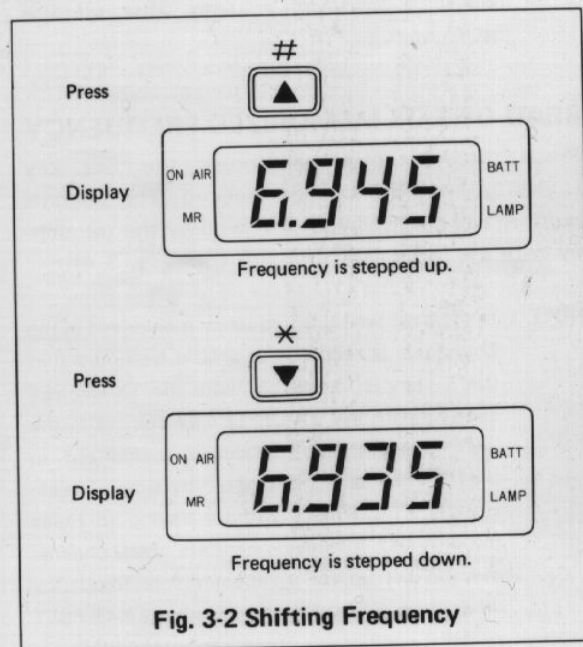

MEMORIZING FREQUENCY

First display the frequency to be memorized by pressing Set keys, then press the **M** key. The MR◀ indicator on the LCD panel will light.

Next, press a Set key (**1** - **0**) to select a storage channel. (See Fig. 3-3)

For example, if you wish to memorize 146.940 MHz in channel 3, proceed:

With the frequency "6940" displayed, press the **M** key. The MR◀ indicator will light and the frequency "6940" disappears. (The MR◀ indicator will go off after about 2 seconds and the frequency "6940" will again appear.)

Press the **3** key while MR◀ is ON. The channel number "3" will be displayed momentarily and then the frequency "6940" will be displayed (MR◀ ON). The frequency is now memorized. Be sure to press the Set key "3" while the MR◀ indicator is ON, or the frequency will not be memorized.

NOTE: When the frequency displayed just before pressing the **M** key is a memory output, the channel number is displayed instantly after pressing the **M** key.

READ OUT OF MEMORIZED FREQUENCY

Press the **MR** key, then press the Set key (**1** - **0**) for the channel desired. The channel number will be displayed, followed by the frequency with the MR◀ indicator ON. (See Fig. 3-4)

NOTE 1: In the case where a frequency memorized in the O channel is read out, it should be noted that the **0** key is interlocked with the TX-OFFSET switch. With the TX-OFFSET switch set in the "M" position, the frequency memorized in the O channel is transmitted by simply pressing the PTT switch, without having to press the **MR** and **0** keys. Therefore, the O channel may be set up for a repeater split frequency other than ± 600 kHz. In all other TX-OFFSET switch positions, operating procedure for memory channels 1 - 9 is standard.

NOTE 2: When a memory output frequency is displayed, the channel number is displayed instantly by pressing the **MR** key.

If you want to confirm the channel number while operating in a memory channel, use this feature.

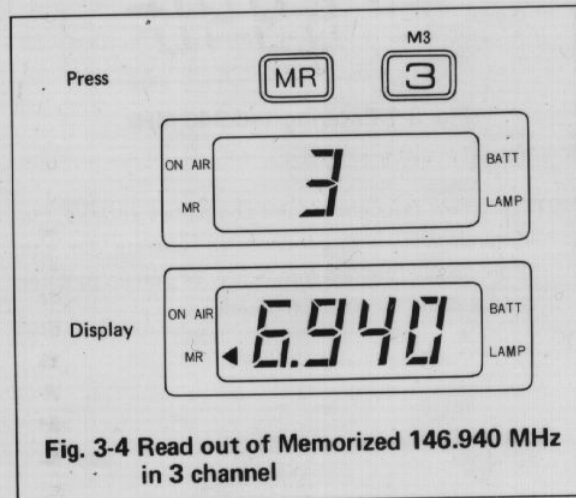
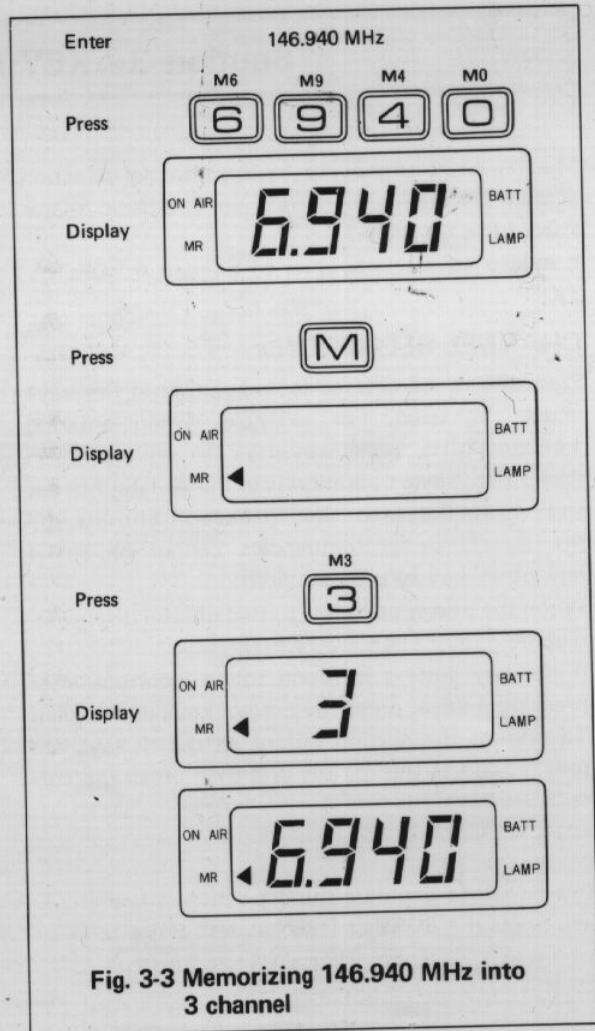

Section 4 OPERATION

SCANNING THE MEMORY CHANNELS

With the **MR** key pressed, the memory channels (1-0) are scanned repeatedly and the frequencies are displayed with the MR ◀ indicator ON. The frequencies are scanned at a speed of 1 channel per second. Select either BUSY or OPEN for scanning the memory channels.

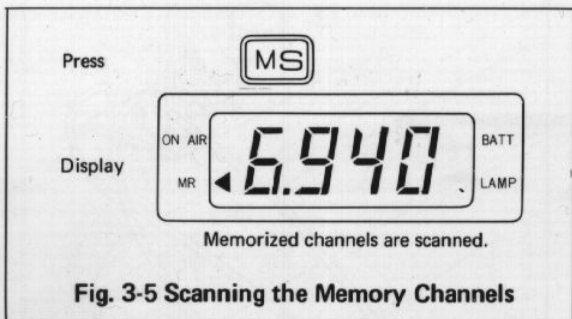

Fig. 3-5 Scanning the Memory Channels

By setting the BUSY or OPEN switch to the BUSY position, scan stops at a channel where signal is present. In the OPEN position, scan stops at an empty channel.

If you wish to continue the scan after it has stopped, press the BUSY or OPEN switch twice to skip and return to the original mode. The scan also stops when the **STOP** key is pressed. To resume scanning, press the **MS** key once again. To release scan operation after pressing the **STOP** key, press the same key again (The display will indicate 5.000). Scan operation is also released when you transmit during scan stop.

TOUCH TONE KEYS

During transmission, the key pad is automatically a Tone pad. Simply press **1** through **0**, **▼** or **▲** as needed.

RECEPTION

1. Turn the power switch **7** ON. The digital display indicates 5.000 (145.000 MHz).
2. Turn the squelch control **3** fully counter-clockwise.
3. Adjust the VOL control **7** clockwise for desired level.
4. Select desired channel or frequency by using the Set keys (**1** - **0**), **▲** and **▼** keys, or by entering frequency (refer to "Section 3 KEY BOARD OPERATION").
5. Adjust the squelch control **3** for suitable level.

TRANSMISSION

1. Select the desired channel or frequency.
2. Set the TX-OFFSET switch to the appropriate position.
3. Press the PTT switch **8** and speak into the microphone **9**. The ON AIR ◀ indicator will light. For optimum results, recommended distance to the microphone is 5-10 cm.

TX-OFFSET SWITCH

The TX-OFFSET switch **2**, used for selecting simplex or repeater operation, has four positions.

- S: Your TR-2400 operates in the usual simplex mode. That is, receive and transmit frequencies are the same.
- + : Transmit frequency is 600 kHz higher than the receive frequency.
- : Transmitter frequency is 600 kHz lower than the receive frequency.
- M: With the TX-OFFSET switch in the M position, the transmit frequency **only** is preset in memory channel 0.

(To preset the transmit frequency, refer to page "MEMORIZING FREQUENCY" in Section 3).

This function allows the TR-2400 to adopt any repeater split frequency.

S-TONE SWITCH

This switch is supplied to control a user supplied and installed tone encoder. Trio-Kenwood does not manufacture or supply this item. To install, refer to Fig. 4-1.

NOTE: Do not attempt to remove the case on the key board side, as it can result in damage to ICs.

Apply some vinyl tapes to the back of the Tone Encoder PC board in order to insulate it from the other parts and the shield plate. Install the Tone Encoder as shown in Fig. 4-1 (d).

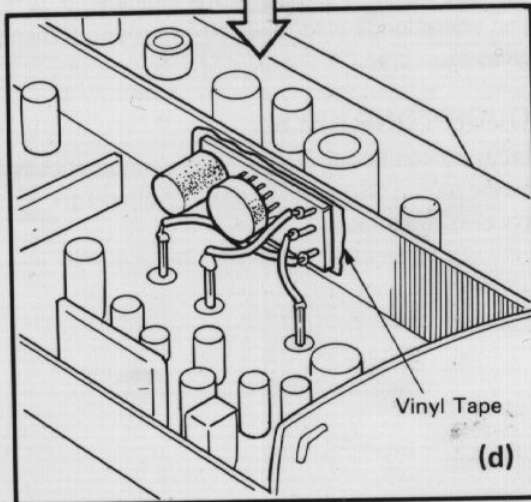
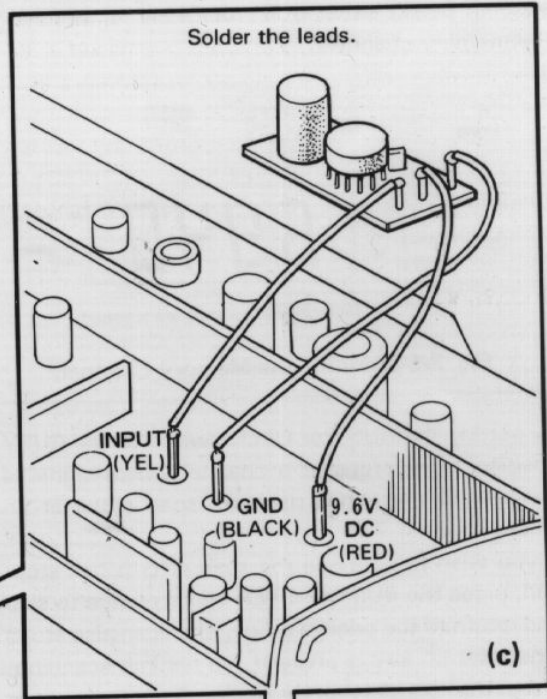
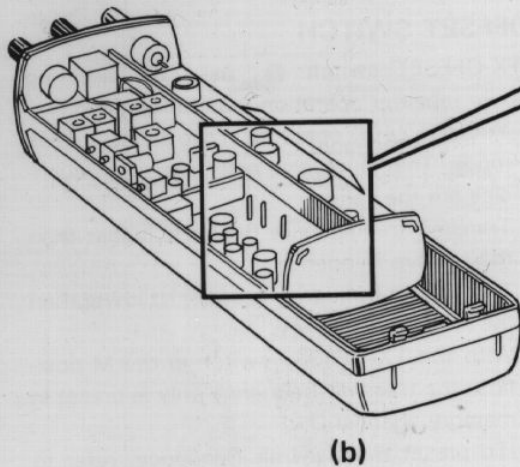
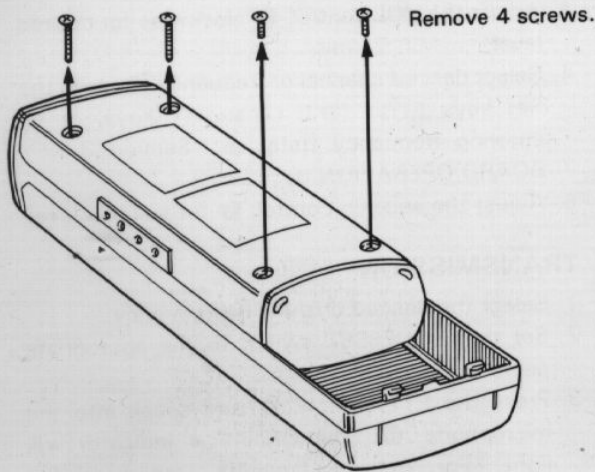

Fig. 4-1 Installing a TONE unit.

Section 5 ADDITIONAL INFORMATION

GENERAL INFORMATION

Your TR-2400 has been factory aligned and tested to specifications before shipment. Under normal circumstances, the transceiver will operate in accordance with these operating instructions. If your transceiver fails to work, contact the Authorized KENWOOD Dealer from which you purchased it for quick, reliable repair. All adjustable trimmers and coils in your transceiver were preset at the factory and should only be readjusted by a qualified technician with proper test equipment.

Attempting service or alignment without factory authorization can void the transceiver's warranty.

ORDERING SPARE PARTS

When ordering replacement or spare parts for your equipment, be sure to specify the following:

Model and serial number of your transceiver, schematic number of the part, printed-circuit-board number on which the part is located, part number and name, if known, and quantity desired.

NOTE: A full Service Manual is available as a separate publication.

SERVICE

Should it ever become necessary to return the equipment for repair, pack in its original box and packing, and include.

1. Model and Serial number of the equipment.
2. A full, detailed description of the problems involved.
3. When claiming warranty service, please include a photocopy of the bill of sale, or other proof of purchase showing the date of sale.
You need not return accessory items unless they are directly related to the service problem.

OPTIONAL ACCESSORIES

1. ST-1 Base Stand

- Built in Pulse type quick charger (1.5 hour) with Full Charge indicator.
- Full operation while charging
 - Trickle charge for extended Base operation
- External MIC Terminal impedance matched for 500 Ω microphone with PTT switching (MC-30S, etc.)
- Spare battery pack charging terminal



2. BC-5 DC-DC Charger

- Cigar Plug connected for Car Batteries.
- Quick type (1.5 hour) with full charge indicator.



3. Leather Case

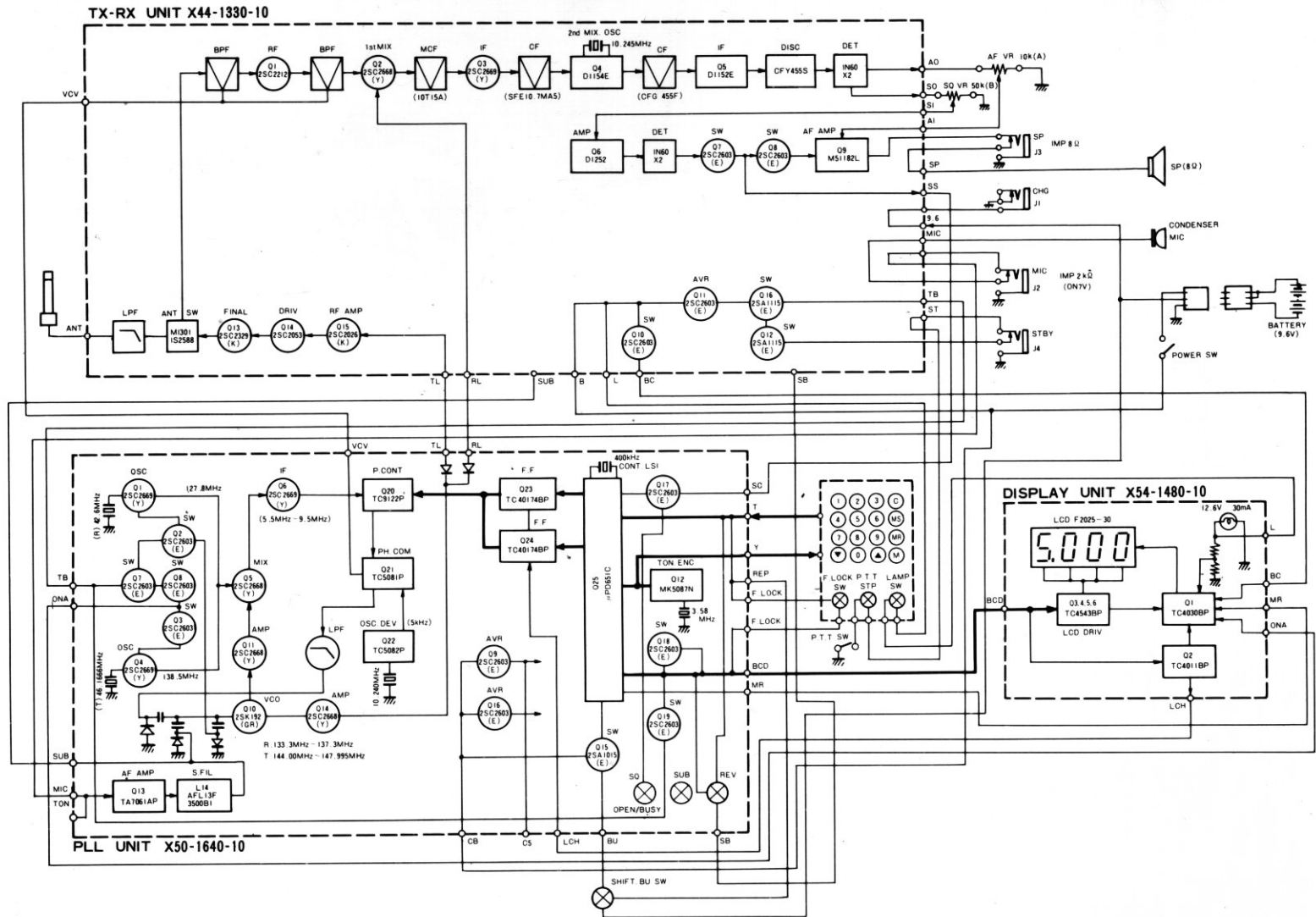

SCHEMATIC DIAGRAM

X44-1330-10

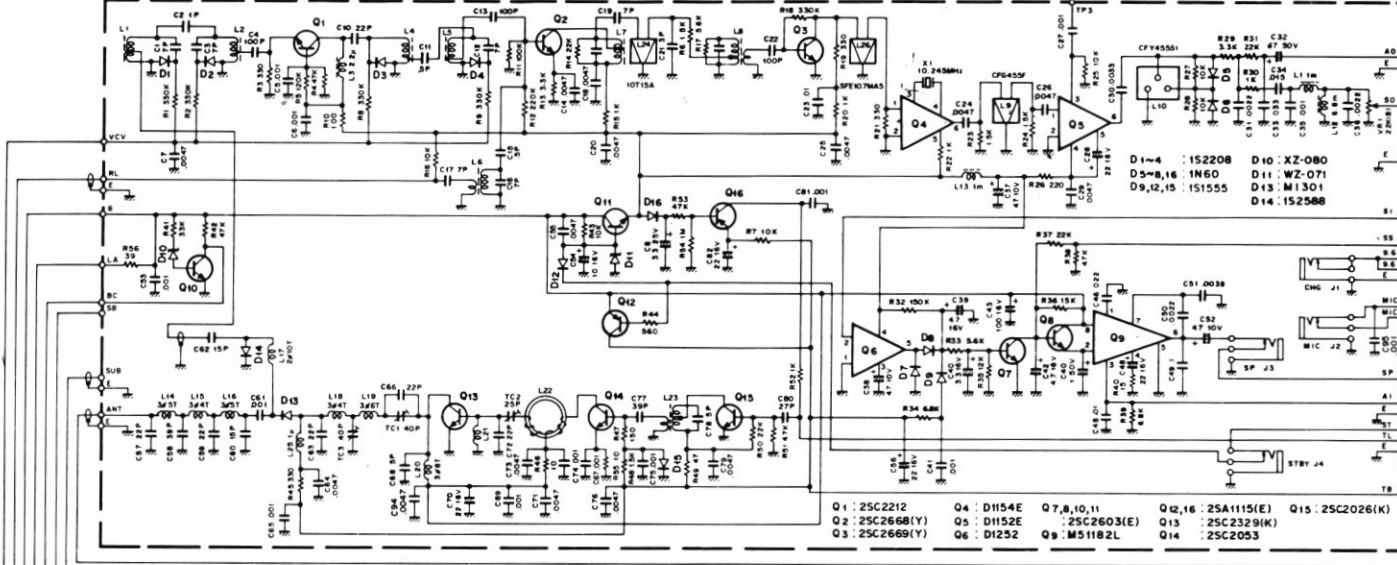

X50-1640-10

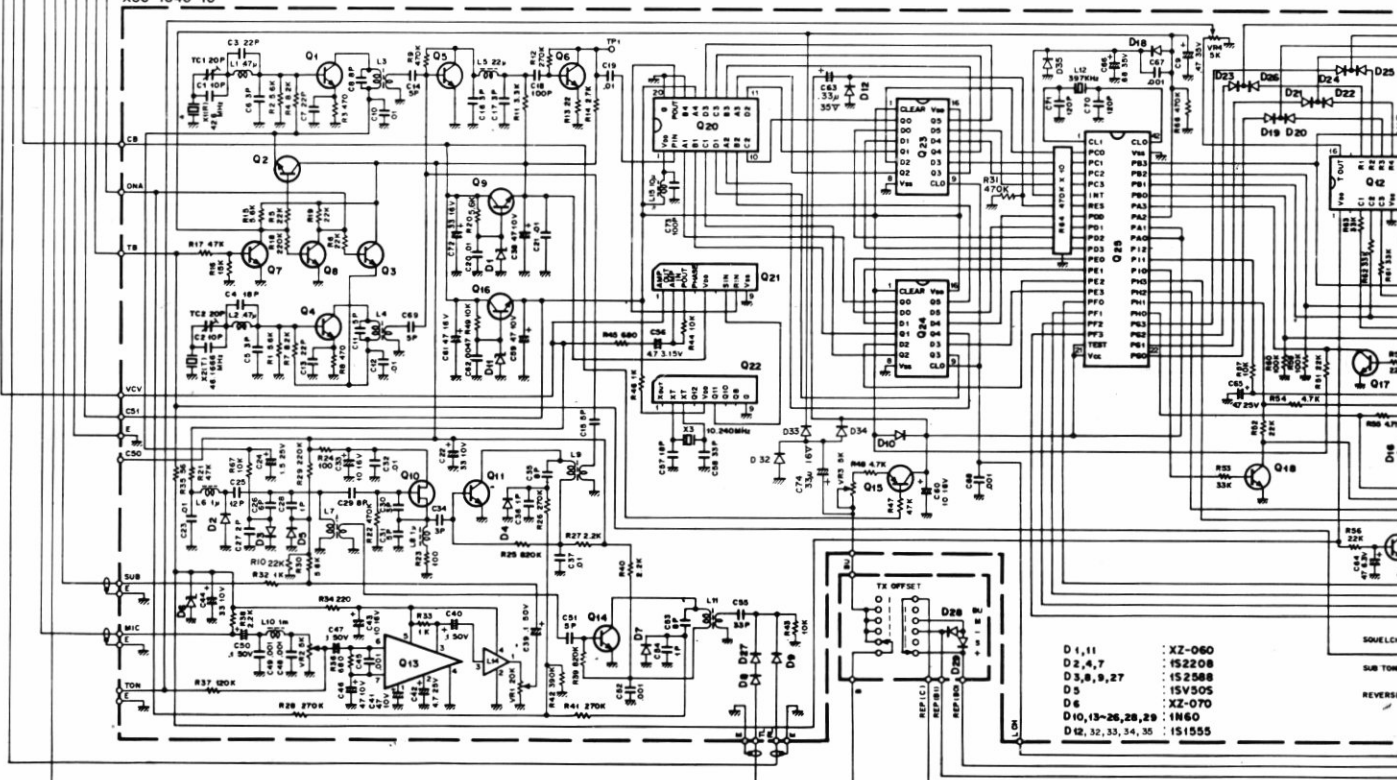

SCHEMATIC DIAGRAM

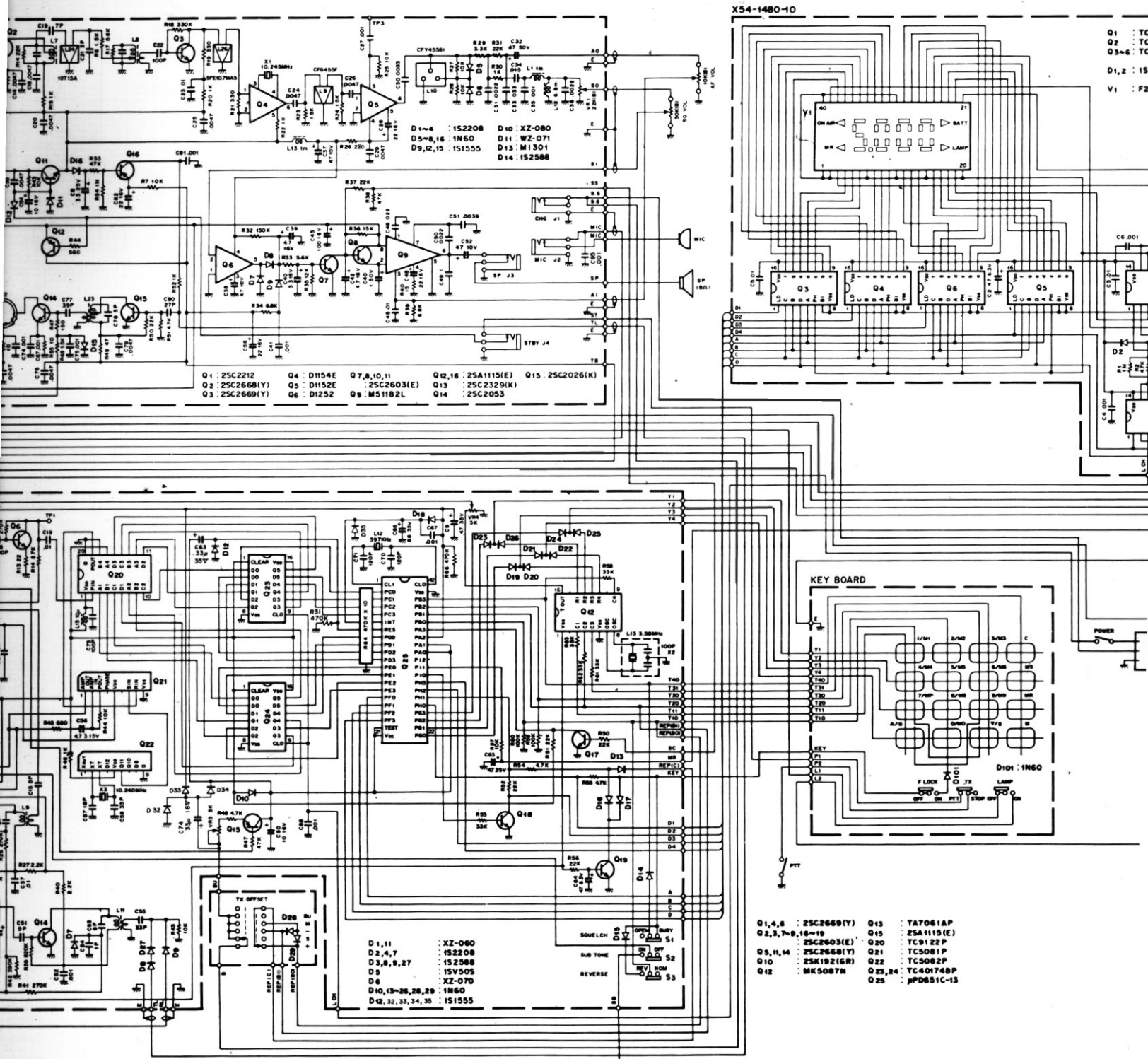

CHEMATIC DIAGRAM

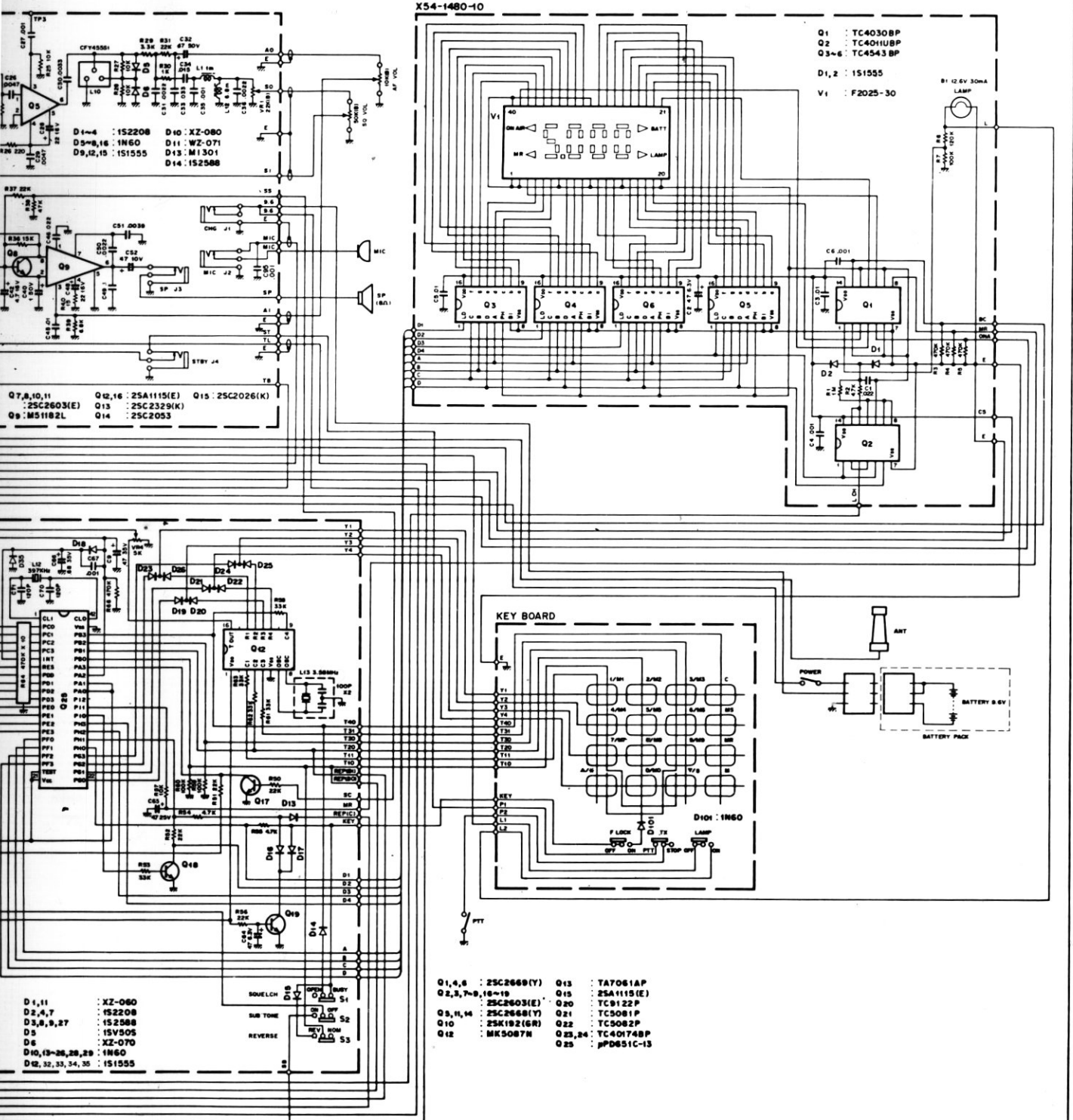

D 1-4 : 152208
 D 5,8,16 : 1N60
 D 9,12,15 : 1S1555
 D 10 : XZ-080
 D 11 : WZ-071
 D 13 : M1301
 D 14 : 152588

Q 7,8,10,11 : 25C2603(E)
 Q 9 : M511B2L
 Q 12,16 : 2SA1115(E)
 Q 13 : 25C2329(K)
 Q 15 : 25C2026(K)
 Q 14 : 25C2053

X54-1480-10

Q 1 : TC4030BP
 Q 2 : TC4011UBP
 Q 3-6 : TC4543BP
 D 1, 2 : 1S1555
 V 1 : F2025-30

KEY BOARD

Q 1, 4, 8 : 25C2668(Y)
 Q 2, 3, 7-9, 16-19 : 25C2603(E)
 Q 3, 11, 14 : 25C2668(Y)
 Q 10 : 25K192(6R)
 Q 12 : MK5087N
 Q 13 : TA7061AP
 Q 15 : 2SA1115(E)
 Q 20 : TC9122P
 Q 21 : TC5081P
 Q 22 : TC5082P
 Q 23, 24 : TC40174BP
 Q 25 : μ PD651C-13

D 1, 11 : XZ-080
 D 2, 4, 7 : 152208
 D 3, 8, 9, 27 : 152588
 D 5 : 15V505
 D 6 : XZ-070
 D 10, 13-26, 28, 29 : 1N60
 D 12, 32, 33, 34, 35 : 1S1555

SOULCH
 SUB TONE
 REVERSE

SCHEMATIC DIAGRAM

