



2m FM TRANSCEIVER

Model TR-7850



INSTRUCTION MANUAL

INTRODUCTION

You are the owner of our latest product, the new TR-7850 transceiver. Please read this instruction manual carefully before placing your transceiver in service. The unit has been carefully engineered and manufactured to rigid quality standard, and should give you satisfactory and dependable operation for many years.

AFTER UNPACKING

- Shipping container:

Save the boxes and packing in the event your unit needs to be transported for remote operation, maintenance, or service.

- The following explicit definitions apply in this manual:

Note: If disregarded, inconvenience only, no risk of equipment damage or personal injury.

Caution: Equipment damage may occur, but not personal injury.

CONTENTS

ACCESSORIES	2
FEATURES	3
SPECIFICATIONS	4
SECTION 1. INSTALLATION	
1.1 Interconnection	5
1.2 Mobile Installation	5
1.3 Fixed Station Installation	6
1.4 Back-up Power	7
SECTION 2. CONTROLS AND TERMINALS	
2.1 Front Panel	8
2.2 Rear Panel	10
SECTION 3. OPERATION	
3.1 Generals	11
3.2 Memory Input	11
3.3 SCAN (Busy stop) Operation	12
3.4 PRIORITY OPER Switch	12
3.5 TX OFFSET and REVERSE	12
3.6 AUTO PATCH Operation	12
3.7 SQUELCH	12
3.8 HI/LOW Switch	12
3.9 Meter	13
3.10 TONE Switch	13
3.11 Adjustments	13
SECTION 4. ADDITIONAL INFORMATION	13
SECTION 5. OPTIONAL ACCESSORIES	14
SCHEMATIC DIAGRAMS	15
BLOCK DIAGRAMS	16

■ ACCESSORIES

Carefully unpack your TR-7850 and check that it is supplied with the following accessories:

- (1) Dynamic microphone (with U/D switch) 500Ω
(T90-0313-05) 1 piece
- (2) Mounting Bracket
 Mounting parts:
 - Hex wrench (W01-0401-04) 1 piece
 - Nuts (5 mm diameter)
 (N14-0510-04) 4 pieces
 - Hex-socket screw
 (N09-0008-04) 4 pieces
 - Flat washers (6 mm diameter)
 (N15-1060-46) 4 pieces
 - Spring washer (6 mm diameter)
 (N16-0060-46) 4 pieces
- (3) Feet
 - Rubber foot (small, rear)
 (J02-0069-05) 2 pieces
 - Rubber foot (large, front)
 (J02-0070-05) 2 pieces
 - Screw (N30-3006-46) 2 pieces
 - Screw (N30-3008-46) 2 pieces
- (4) DC power cord (with 2P plug and fuse)
(E30-1685-05) 1 piece
- (5) Spare fuse (10A) (F05-1031-05) 1 piece
- (7) Miniature plug (for external speaker)
(E12-0001-05) 1 piece
- (9) Warranty card 1 copy
- (10) Instruction manual 1 copy

FEATURES

- **15 MULTIFUNCTION MEMORY CHANNELS, EASILY SELECTABLE WITH A ROTARY CONTROL**
M1—M13... memorize frequency and offset (± 600 kHz or simplex)
M14, MO..... memorize transmit and receive frequencies independently for nonstandard offset.
MO..... priority channel with simplex, ± 600 kHz, or nonstandard offset operation.
- **INTERNAL BATTERY BACKUP FOR ALL MEMORIES**
All memory channels (including transmit offset) are retained when four AA Ni-Cd batteries (not KENWOOD supplied) are installed in battery holder inside TR-7850. Batteries are automatically charged while transceiver is connected to 12V DC source.
- **PRIORITY ALERT**
MO memory is priority channel.
- **EXTENDED FREQUENCY COVERAGE**
143.900 ~ 148.995 MHz in switchable 5 kHz or 10 kHz steps, allowing simplex and repeater operation on many MARS frequencies.
- **BUILT-IN AUTOPATCH DTMF ENCODER**
Keyboard operates as autopatch encoder to access repeater autopatch.
- **FRONT-PANEL KEYBOARD**
For frequency selection, transmit offset selection, memory programming, scan control, and selection of autopatch encoder tones.
- **AUTOSCAN**
Entire band (5 kHz or 10 kHz steps) and memories. Automatically locks on busy channel; scan resumes automatically after several seconds unless CLEAR or mic PTT button is pressed to cancel scan.
- **SEPARATE DIGITAL READOUTS**
To display frequency (both receive and transmit) and memory channel.
- **SELECTABLE POWER OUTPUT**
40 watts (Hi)/Low Power (1 to 15W)
- **BUILT-IN PIEZO-ELECTRIC BUZZER**

BEFORE USE



Do not adjust coils, trimmers, or pots!
These are factory adjustments.

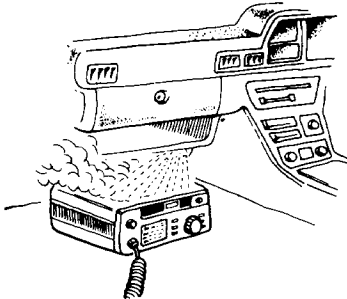

Do not install near heater outlet.

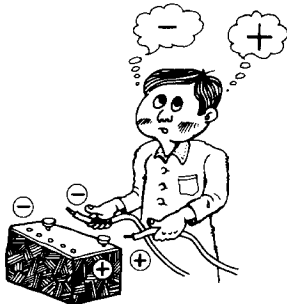

BEFORE connection, check polarity.

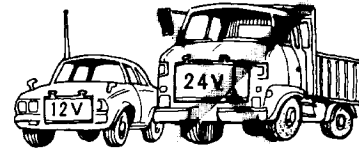

This unit is designed for 12V, negative ground ONLY.

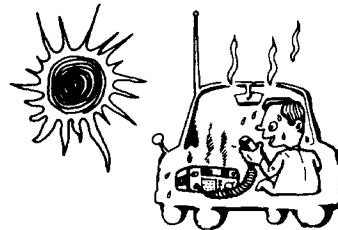

After parking in the sun, and inside temperature is HOT,
cool this unit BEFORE transmitting.

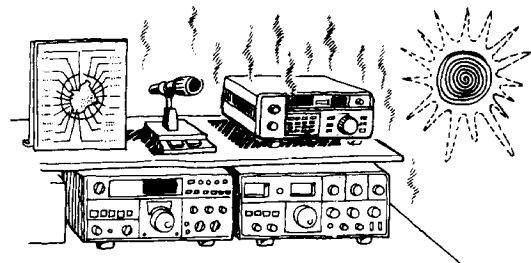

Keep equipment away from heat and out of direct sunlight.

SPECIFICATIONS

[General]

Semiconductors	MPU	1
	ICs	19
	Transistors	60
	FETs	9
	Diodes	79
Frequency range	144.000 to 147.995 MHz	
Frequency synthesizer	Digital control, phase locked VCO	
Mode	FM (F3)	
Antenna impedance	50 ohm	
Power requirement	13.8V DC \pm 15%	
Grounding	Negative	
Operating temperature	- 20°C to + 50°C	
Current drain	0.4A in receive mode with no input signal 9A in HI transmit mode (Approx.) Less than 3 mA for memory back up (from an external power supply through the back up terminal) Less than 2 mA for memory back up (from battery)	
Dimensions	175 mm (6-7/8") wide 64 mm (1-1/2") high 220 mm (8-5/8") deep (projections excluded)	
Weight	2.2 kg (4.84 lbs) (approx.)	

[Transmitter Section]

RF output power (at 13.8V DC, 50Ω load)	HI	40 Watts min.
	LOW	1 to 15 watts approx. (According to FREQ.)
Modulation	Variable reactance direct shift	
Frequency tolerance	Less than $\pm 20 \times 10^{-6}$	
(- 20°C ~ + 50°C)		
Spurious radiation	HI	Less than - 60 dB
	LOW	Less than - 53 dB
Maximum frequency deviation (FM)	\pm 5 kHz	
Microphone	Dynamic microphone with PTT switch, 500Ω	

[Receiver Section]

Circuitry	Double conversion superheterodyne	
Intermediate frequency	1st IF	10.695MHz
	2nd IF	455kHz
Receiver sensitivity	Better than 0.5μV for 30 dB S/N Better than 0.2μV for 12dB SINAD	
Receiver selectivity	More than 12kHz (- 6dB) Less than 24 kHz (- 60dB)	
Spurious response	Better than 60 dB	
Squelch sensitivity	0.16μV (threshold)	
Auto scan stop level	Less than 0.2μV (threshold)	
Audio output	More than 2.0 watts across 8 ohm load (10% dist.)	

Note: Circuit and ratings are subject to change without notice due to developments in technology.

SECTION 1 INSTALLATION

1-1 Interconnection

Connect the antenna and power supply as shown in Fig. 1-1 for fixed station.

1-2. MOBILE Installation, [general]

• Installation location

Using the supplied mounting bracket, install the transceiver under the dashboard or on the side of the console in your car. Mount the unit for safe operation: easy keyboard access, and display visibility.

Refer to Fig. 1-2A and Fig. 1-2B.

If your car is equipped with an electronic fuel injector, the transceiver should be as far from the control equipment as possible.

Antenna installation

Various types of antenna for 2 meter mobile operation are available. (See Fig. 1-2C)

NOTE:

For gutter-mount installation, the antenna bracket must be grounded to the car body as shown in Fig. 1-2C. Affix the antenna securely, referring to the antenna instruction.

• Power supply

Connect the supplied power cord with fuse directly to the battery terminals. Connecting to the cigarette lighter socket can cause a poor connection, and excessive voltage drop.

• Ignition noise

The transceiver is designed to suppress ignition noise; however, if excessive noise is present, it may be necessary to use suppressor spark plugs (with resistors).

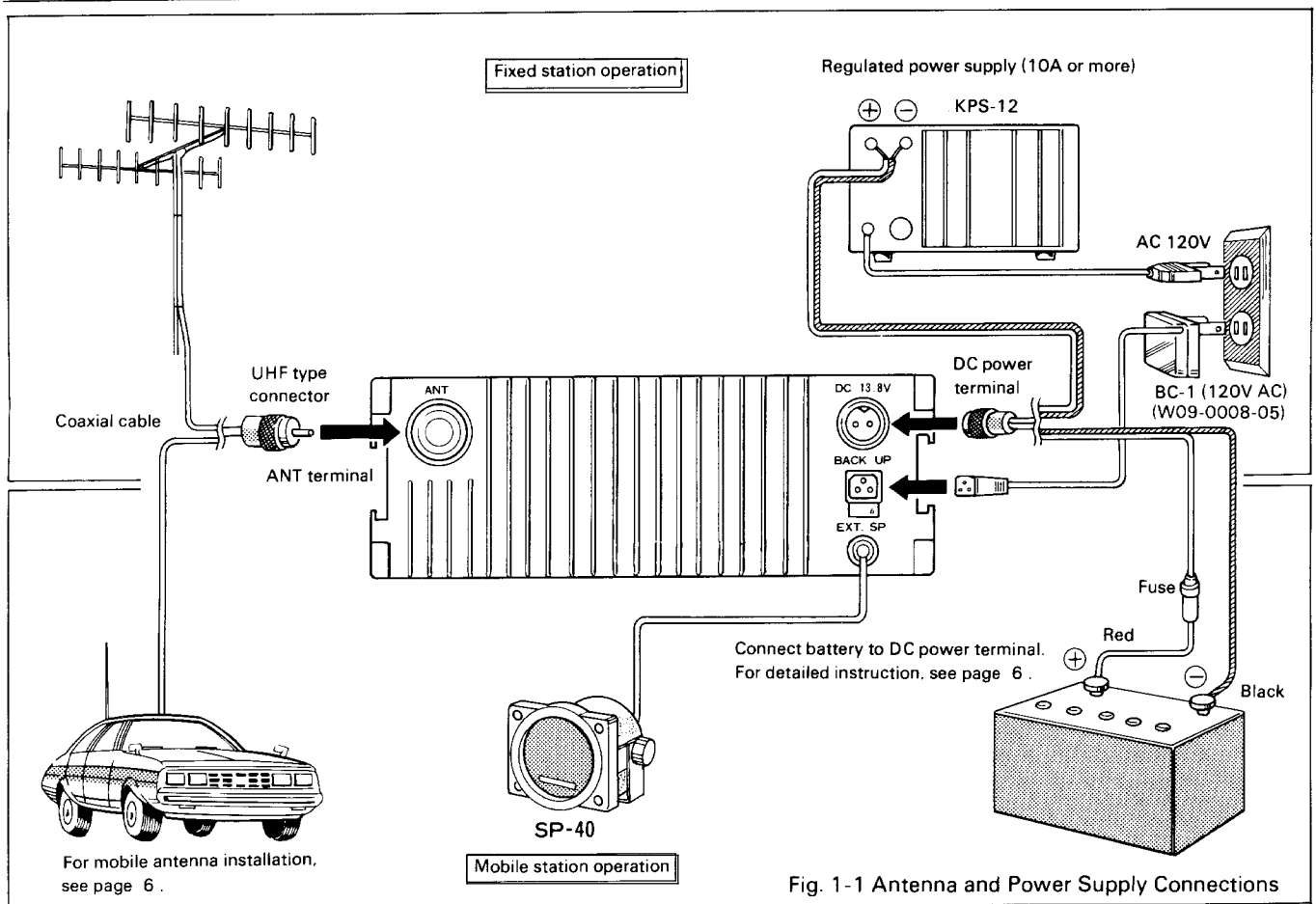

Fig. 1-1 Antenna and Power Supply Connections

1-3. FIXED STATION Installation, [general]

• **Power supply (Fig. 1-3)**

A regulated DC power supply (13.8V DC, 10A or more) is required.

• **Antenna (Fig. 1-3)**

Various types of fixed station antennas are commercially

available. Select your desired antenna according to your installation space and application.

Note that the SWR of your antenna should be less than 1.5. A high SWR will cause the TR-7850 protective circuit to operate, reducing the transmit output power.

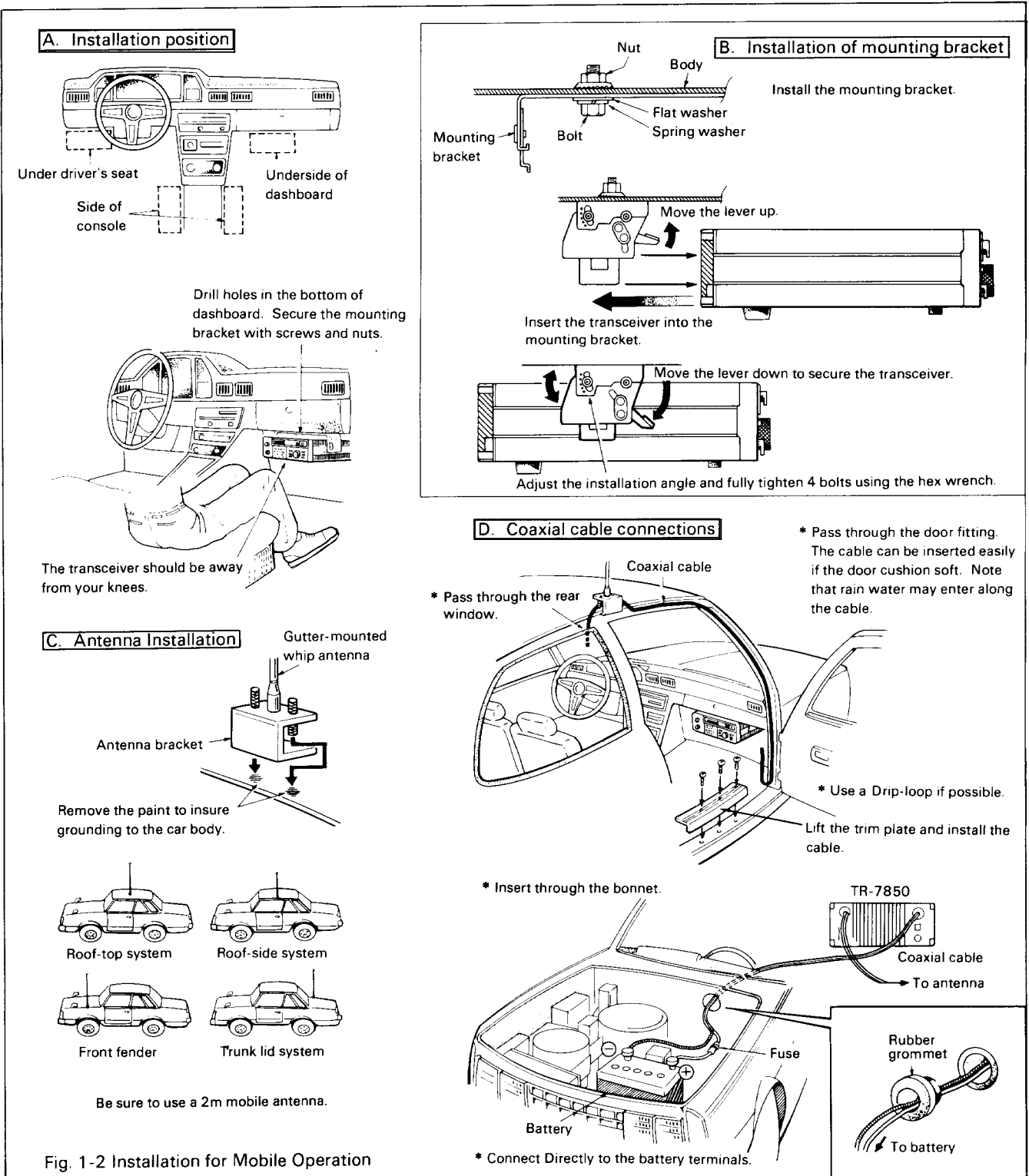

Fig. 1-2 Installation for Mobile Operation

1-4. Back-up Power

1. With power supplied directly from the car battery, the micro computer continues operating even when the power switch is OFF.
Current drain is very low, approximately 2.5 mA.

2. If you wish to retain the memories even when moving the unit between the car and the fixed station, utilize a battery back-up system. Otherwise, all the memories are cleared when the power cord is disconnected.

[Battery Back-up]

- (1) Use four AA NiCd batteries, available Locally.
- (2) Open the lower cover of the transceiver.
- (3) Install the batteries into the battery case located on the left side, making sure that polarity is correct.

(4) The batteries are charged regardless of the power switch position.

Charging current is about 15 mA. The battery back-up function operates only when the power cord is disconnected.

3. Back-up is available for about 3 to 5 days. To extend the back-up period, connect the (optional) BC-1 to the external back-up terminal.

[NOTE]

1) Remove the batteries if you don't intend to use them for a long period of time.

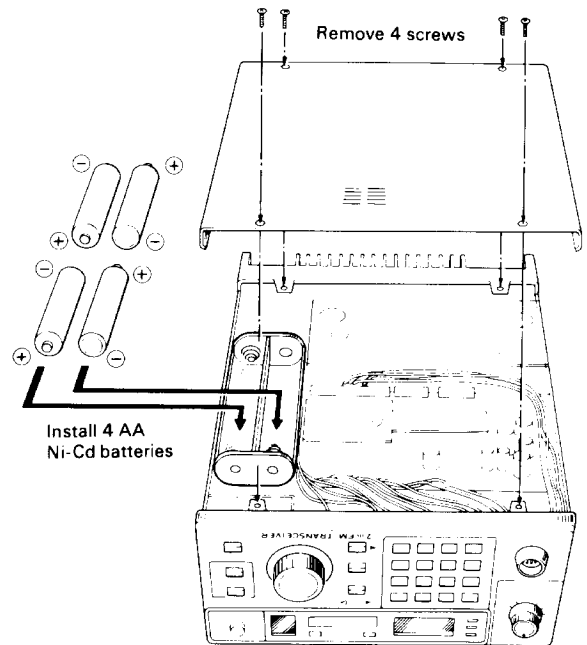

Fig. 1-4 Battery Back-up

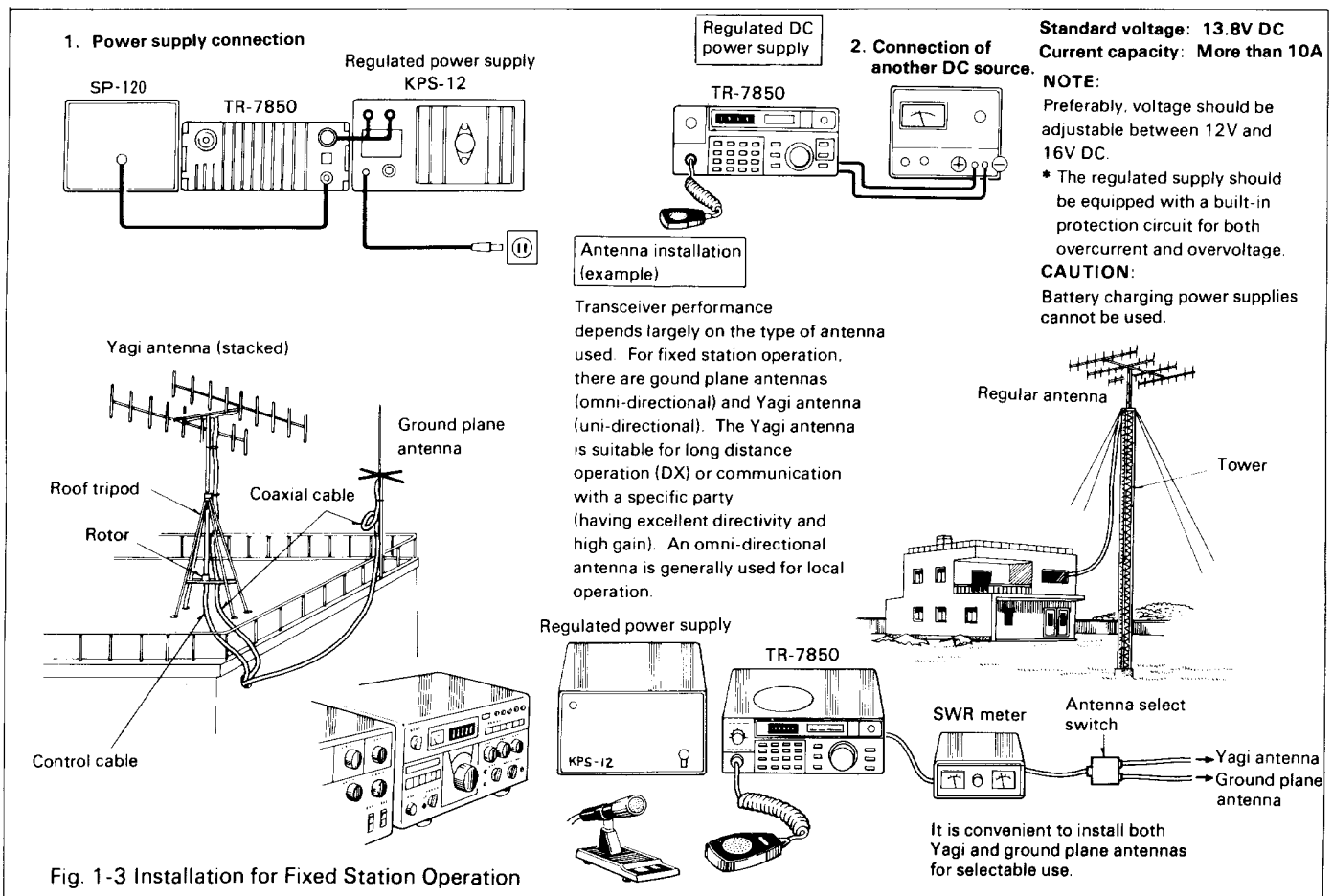
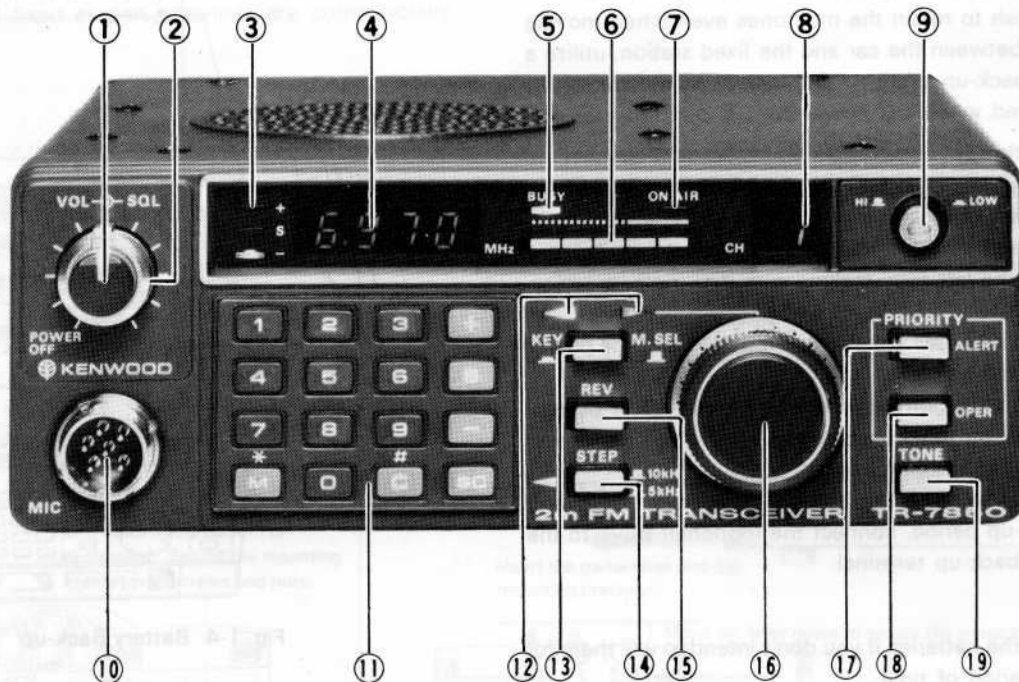

Fig. 1-3 Installation for Fixed Station Operation

SECTION 2. CONTROLS AND TERMINALS



2-1. Front Panel

1. VOL/POWER

Power ON-OFF switch and volume control are combined. Turning the control fully counter clockwise will turn the power OFF. Clockwise rotation will increase the volume. In the power OFF position, about 2.5mA current is drawn to back-up the micro-computer and about 6mA of leakage current for final module, provided the power cable is connected to a constant power source.

To completely disable the transceiver, disconnect the power cable.

2. SQUELCH

The squelch control is used to eliminate noise during no-signal time. Normally, this control is adjusted clockwise until the noise disappears and the BUSY indicator goes off (threshold level). For scan operation, this control must be set to the threshold point.

3. TX Shift Indicator

+ (RED): By pressing the \oplus key on the keyboard (11), the indicator will light, indicating that transmit frequency is switched up 600 kHz from the receive frequency.

S (YELLOW): By pressing the S key on the keyboard # (11), the indicator will light, indicating that the transceiver is operating in the simplex mode.

- (RED): by pressing the \ominus key on the keyboard # (11), the indicator will light, indicating that transmit frequency is switched down 600 kHz from the receive frequency.

4. Frequency Display

This LED frequency display indicates the operating frequency in 4 digits (MHz-kHz).

Example: 146.940 MHz is indicated as "6.940".

5. BUSY Indicator

This lamp will light when the squelch is open in receive mode.

6. S/R Level meter

This LED level meter indicates receive input signal strength (in S units) or transmit output (RF).

7. ON AIR Indicator

A light emitting diode (L.E.D) will light during transmit mode.

8. CH Indicator

This indicates the channel No., 0 through 14, in 2 digits.

9. HI/LOW Switch

This switch is used to set transmit output power to either 40W (high) or low power (1 to 15W).

Power is high at the normal out position (■), and is low at the in position (▬). (refer to Page 13)

10. MIC Connector (6-pin)

For connection of the supplied microphone.

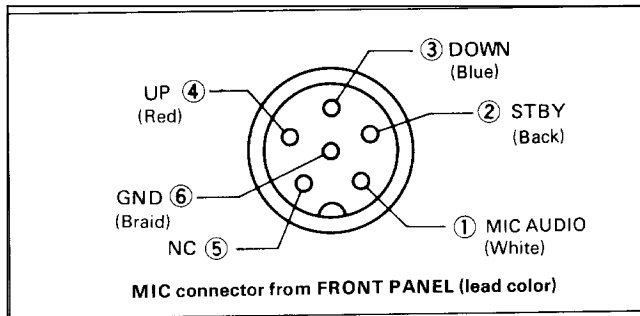

11. Keyboard

The keyboard has the following functions (Refer to "SECTION 3. OPERATION"):

① - ④ (Number keys):

Depress four keys to set the desired operating frequency.

Example: Depress the ⑥, ⑨, ④ and ④ keys. The frequency display will indicate "6.940" (146.940 MHz).

The number keys function as auto-patch keys during transmit mode.

+ (+ shift key):

After setting the operating frequency, depress this key. The transmit frequency will be offset 600 kHz up from the receive frequency.

S (Simplex key):

Depress this key and the transceiver will remain in simplex mode (transmit and receive frequencies are the same).

- (- shift key):

After setting the operating frequency, depress this key. The transmit frequency will be offset 600 kHz down from the receive frequency.

* (Memory key):

This is used to input the desired frequency (including ± 600 kHz offset) to each channel for memory. Press the key and a check-tone will be heard.

(Clear key):

By pressing this key, the frequency set by the number keys is cleared. When cleared, the frequency display will indicate the frequency that was displayed before the last entry was cleared. Use this key you have mistakenly entered setting this key is also used to release the scan operation.

Ⓢ (Scan key):

This is used for scan operation. Press the key when the SQUELCH (2) is ON. This will start auto-scan or memory-scan depending on the position of the KEY/M. SEL switch and STEP switches.

Auto Patch:

During transmission, keys 1 ~ 9, * and # operate DTMF. Keys ③ ⑥ ⑨ ④ will operate fourth column in conjunction with the REV switch.

12. KEY/M. SEL Indicator

This indicates the position of the KEY/M. SEL switch. The KEY indicator will light when the switch is depressed (▬), and the M. indicator will light in the out position (■).

13. KEY/M. SEL Switch

This switch is used to select the method of setting frequency, either by the keyboard or the memory. In the (▬), in position, the operating frequency is set by the keyboard; in the normal out position (■), the operating frequency can be set by using the MEMORY channel selector (16).

14. STEP Switch

Use this switch to select the steps (■: 10 kHz, ▬: 5kHz) during frequency scan or microphone UP/DOWN operation.

15. REV Switch

In receive, this switch is used to reverse the repeater shift (± 600 kHz) and other transmit/receive frequencies (CH 0, 14). It is a momentary non-lock type switch and returns to the normal out position when released.

In transmit, this switch shifts DTMF tones on column 3 to column 4 (ABCD) function.

16. MEMORY Channel Selector

This switch is used to select one of 15 memory channels. Of these, channels 1-13 store frequencies including ± 600 kHz offset. The other two channels, 1 and 14 are "ODD slit" channels, storing transmit and receive frequencies individually.

Channel "0" is the priority channel.

17. PRIORITY ALERT Switch

This switch is used to check the priority, channel "0". Depress the switch and the priority channel will be checked at about a 6 second interval regardless of the KEY/M. SEL switch position. A tone sounds when the priority channel is in use.

18. PRIORITY OPER Switch

This switch is used to call-up the priority channel "0". By depressing the switch, operating frequency is switched to the priority channel.

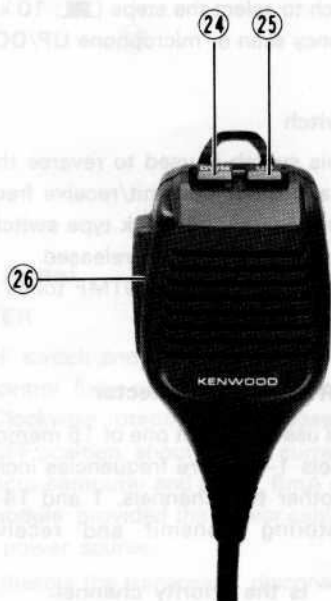
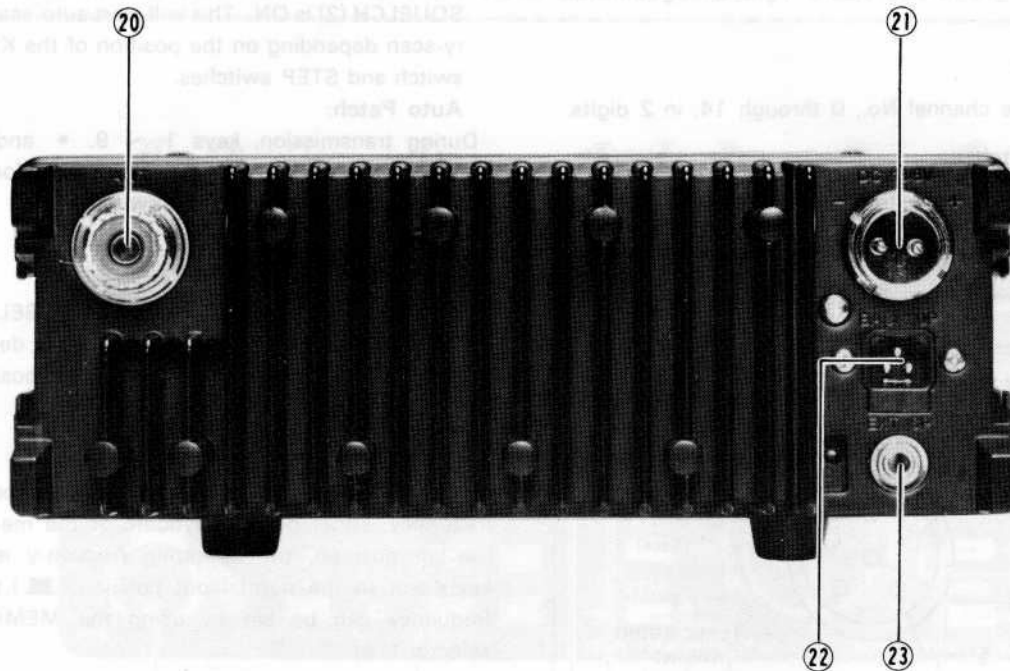

19. TONE Switch

The tone switch is for control of a user-supplied tone generator (not available from TRIO-KENWOOD).

2-2 Rear Panel

20. ANT Terminal

Antenna terminal. Connect an antenna of 50 ohms impedance.

21. DC Power Terminal

DC power input terminal. Connect the supplied power cord with plug. Input voltage is 13.8V DC. Observe plus (+) and minus (-) polarity!

22. EXT. BACK-UP

External power back-up terminal to retain the memories. For internal back-up operation, install four AA NiCd batteries in the built-in battery case. Use this terminal to retain the memories for a long period of time (more than 1 week), or with the power cord disconnected.

23. EXT. SP Terminal

External speaker terminal. Connect an 8 ohms speaker using the supplied plug.

24. DWN Switch

This switch is used to step the operating frequency down during both keyboard and MEMORY Channel operation. When pressing the switch, a tone will sound. When the UP or DWN switch is held on, frequency shifts rapidly.

Pressing both the UP and DWN switches simultaneously results in stopping the frequency control operation.

25. UP Switch.

This switch is used to step up the operating frequency in both keyboard and MEMORY channel operation. When pressing the switch, a tone will sound.

26. PTT Switch

Press-to-talk switch used for transmission. This will also release scan operation.

SECTION 3 OPERATION

3-1 General

1. This transceiver uses a PLL synthesizer controlled by micro-computer. The operating frequency can be shifted in either 5 kHz or 10 kHz steps.
2. The transceiver covers a wide frequency range of 143.900 to 147.995 MHz (which includes some MARS frequencies).
3. Operating frequencies can be set by simply pressing the keys on the keyboard. Frequencies can also be stored in the (15) memory channels.
4. Transmitter precautions
 - (1) The TR-7850 antenna impedance is 50 ohms. Be sure to connect an antenna of 50 ohms impedance.
 - (2) Check the transmit frequency before operating to insure that you do not interfere with other stations.
 - (3) By pressing the microphone PTT switch, the TR-7850 is set in transmit mode; the ON AIR indicator will light and the meter indicates transmit power. Hold the microphone about 5 cm from your mouth and speak.
5. Micro-Computer Reset (At first power-up)

If, at initial TURN—ON, an erroneous or incorrect read-out is displayed, reset the MICRO—COMPUTER. This is not an equipment malfunction.

 - (1) Disconnect the power plug from the DC power terminal (21) and after about five seconds reconnect the power plug. Turn on the power switch (1).
 - (2) BACK-UP BATTERIES INSTALLED

First remove the batteries, and reset the MICRO—COMPUTER as previously described. Reinstall the batteries.

3-2 Memory Input

The TR-7850 has two different memories; normal memory and split channel memory (including priority memory channel).





1. Normal memory (CH 1-13)

Example: To store 146.940 MHz (- 600 kHz shift) in CH 5,









- (1) Set the KEY/M.SEL switch to the KEY position ().
- (2) Set the MEMORY channel selector (16) to the CH 5 position.
- (3) Enter the frequency.

[DISPLAY]



Frequency before
input:

- a) Press the  key (MHz digit) 5.
- b) Press the  key (100 KHz digit)..... 59
- c) Press the  key (10 kHz digit) 594
- d) Press the  key (1 kHz digit) 5940

(Simplex operation)

- (4) Input the shift mode.
Press the  key (the indication changes from "S" to " - ").
 - (5) Store the frequency in the memory.
Press the  key.
A tone will sound, indicating data entry. Change the channel and input other frequencies in the same manner.
- Notes: (MEMORY input)**
- a. To input MHz digits, use the 3 through 8 keys.
 - b. When the MHz digit is 3, use only the 9 key to the input the 100 kHz digit.
 - c. When a wrong frequency is input in error, press the  key to clear the frequency. The frequency display will indicate the previous frequency before the last input. Reenter the correct frequency by again pressing the keys, starting with the MHz digit.
 - d. When the 1 kHz digit keys ( - ) are pressed, the frequency display indicates  . When the ( - ) keys are pressed, the display indicates 5.
 - e. Do not press any other key until the correct frequency is input. The transceiver holds the previous frequency until the new frequency is input.

Notes: (GENERAL)

- 1q If you wish to change the shift mode from simplex, press the shift key for the desired offset.
2. For frequencies outside the 144.00 — 174.995 MHz amateur band, the transceiver operates in simplex mode independent of the  or  keys.
3. When the transmit frequency is offset (± 600 kHz) and is outside the amateur band, the transceiver will operate thusly:

Indication

 4.100

Press the  key:

 4.100

Shift mode is indicated.

Press the  key:

 4.100

Frequency is out-of-band and is not stored in memory.
(Tone does not sound.)

Transmit: Mode changes to simplex, pressing the PTT switch.
(Tone sounds at this time.)

Receive: Remains in simplex mode at PTT release.

The simplex frequency can now be memorized.

2. Split channel memory (CH 0, 14)

Example: To store 146.580 MHz receive and 147.660 MHz transmit in CH 14, proceed as follows:

1. Set the KEY/M.SEL switch (13) to the KEY position (■).
2. Set the memory channel selector (16) to CH 14.
3. Enter the receive frequency. Frequency before input
 - a) Press the [5] key (MHz digit)..... 5.
 - b) Press the [5] key (100 KHz digit).... 5.5
 - c) Press the [8] key (10 kHz digit)..... 5.58
 - d) Press the [0] key (1 kHz digit)..... 5.580

Note:

For frequency input precautions, refer to "Notes" in the preceding section.

- (4) Store the receive frequency in memory. Press the [M] key. A pulsed tone will sound, indicating transmit frequency is ready to be accepted.

Note:

1. The tone will sound intermittently until the transmit frequency is stored in memory.
2. When the receive frequency is stored, transmit frequency before the split (CH 14) is indicated.

- (5) Enter the transmit frequency.
 - a) Press the [7] key (MHz digit)..... 7.
 - b) Press the [5] key (100 kHz digit)..... 7.5
 - c) Press the [5] key (10 kHz digit)..... 7.55
 - d) Press the [0] key (1kHz digit)..... 7.550
- (6) Store the transmit frequency in memory. Press the [M] key (tone stops.)..... 5.580

The transceiver is now ready for split frequency operation.

Set the KEY/M. switch (13) to the M. position (■).

NOTE:

After the transmit frequency is stored, the frequency display indicates the receive frequency previously set by step (3).

3. Memory channel operation

With the KEY/M.SEL switch in the M. position (■), the transceiver operates on the frequency set by the MEMORY channel selector (16).

4. Changing memory frequencies.

If you wish to change any memory frequency, store a new frequency in that channel using the above procedures. The old frequency is erased when the new frequency is stored.

3-3 SCAN (Busy stop) Operation

The SCAN operation is divided into keyboard scan, memory scan and priority channel scan. For SCAN operation, the squelch control should be advanced to the threshold point. See section 3.7, Squelch.

• KEYBOARD SCAN

1. Set the KEY/M.SEL switch (13) to the KEY position (■).
2. Depress the [SC] key. Scan starts automatically in 10 kHz or 5 kHz steps depending on the position of the STEP switch (14).
3. When a signal is present, scanning stops. Scan restarts automatically after about 5 seconds.
4. To release the scan, press the [C] key (or the microphone PTT switch).

• MEMORY SCAN

1. Set the KEY/M. SEL switch (13) to the M. SEL position.
2. Depress the [SC] key. The memory channels are scanned. Scan stops and restarts the same as in keyboard scan.

• PRIORITY CHANNEL SCAN

Depress the PRIORITY ALERT switch (17). Regardless of the KEY/M. SEL switch position, a tone will sound and the BUSY indicator (5) will light at about 6 seconds intervals if the PRIORITY channel is in use. Traffic on the PRIORITY channel will also be momentarily heard.

3-4 PRIORITY OPER Switch

To call-up the frequency stored in the priority "0" channel depress the PRIORITY OPER switch (19).

3-5 TX OFFSET and REVERSE

After setting channel frequencies by the keyboard, press the [+] or [-] key. Transmit frequency will be offset plus or minus 600 kHz from the receive frequency and the TX shift indicator (3) will display the offset.

By pressing the REV switch (15), the transmit and receive frequencies will be reversed. If, at this time, the transmit frequency is beyond the amateur band frequency, a tone will sound and the transceiver is automatically in simplex mode. When the REV switch is pressed, the frequency indicated on the display is also reversed, but the TX shift indicator (3) will not change.

3-6 AUTO PATCH Operation

With the PTT switch depressed, the keybooses operates in DTMF. Tone signals will be transmitted for auto patch operation. In transmit, to operate the fourth column (ABCD), had the REV switch in and key the third column (3, 6, 9, #).

3-7 SQUELCH

To eliminate receiver noise at the no-signal condition, slowly adjust the squelch clockwise until the noise disappears and the BUSY indicator goes off (threshold point).

The squelch will open, the BUSY indicator will light and the speaker will operate when a signal is received.

The squelch control is also used for scan operation control. If the signal is weak or fades during mobile operation, readjust the squelch for consistent reception.

3-8 HI/LOW Switch

For local communication, it is recommended that power be reduced to eliminate interference to other stations and to minimize power consumption. By pressing the HI/LOW switch, transmit power is reduced from 40W to about 5W.

3-9 Meter

The LED level meter functions as an "S" meter during reception. One LED ON equals 0 dBμ, Five LEDs ON equal 20 dBμ (+ 10, -2 dB). During low power transmission, 3 LED's will light (at 146 MHz), and 5 LED's will light during high power transmission.

3-10 TONE Switch

This switch is provided to control a user supplied and installed tone encoder. TRIO-KENWOOD does not manufacture or supply this item.

To install, refer to Fig. 3-1.

3-11 Adjustment

• Low Power

The TR-7850 low power characteristic is shown in Fig. 3-2.

Low power may be adjusted by VR4, shown in Fig. 3-3.

• Deviation

On the RX unit X55-1270-10, VR3 adjusts mic deviation, clockwise increases deviation.

On the control unit X53-1180-10, VR1 adjusts tone deviation, clockwise reduces tone deviation.

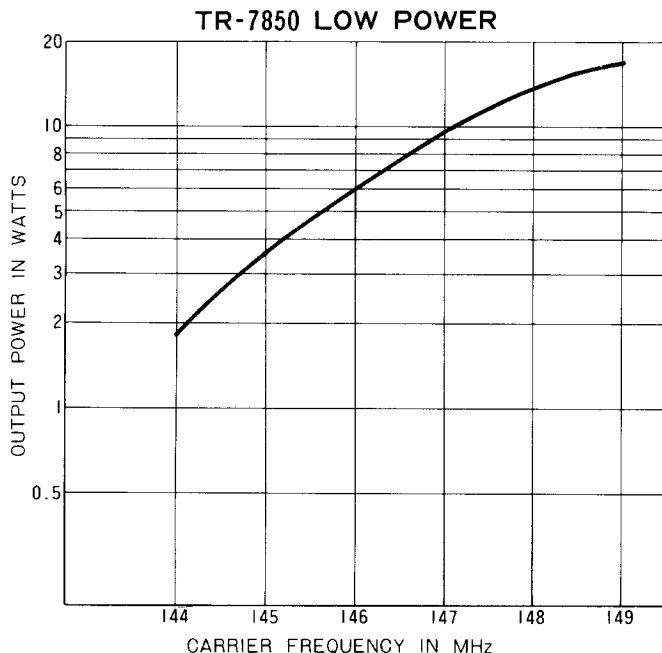

Fig. 3-2

3-12. Miscellaneous Information

1. Frequency step-up at power switch ON or OFF.
 - In KEY mode operation, the frequency may step by one step, according to the selected channel step.
 - In memory mode operation, the channel number may advance by one channel. These are normal, and not a malfunction.

2. Power consumption at power switch OFF.

The final power amplifier in this high-power transceiver is fed directly from the power source without passing through the power switch.

For this reason, about 6 mA of leakage current is consumed by the final section when the power switch is off.

Backup current at about 2.5 mA is consumed to retain memories.

If backup batteries are installed, charge current at about 15 mA is also consumed.

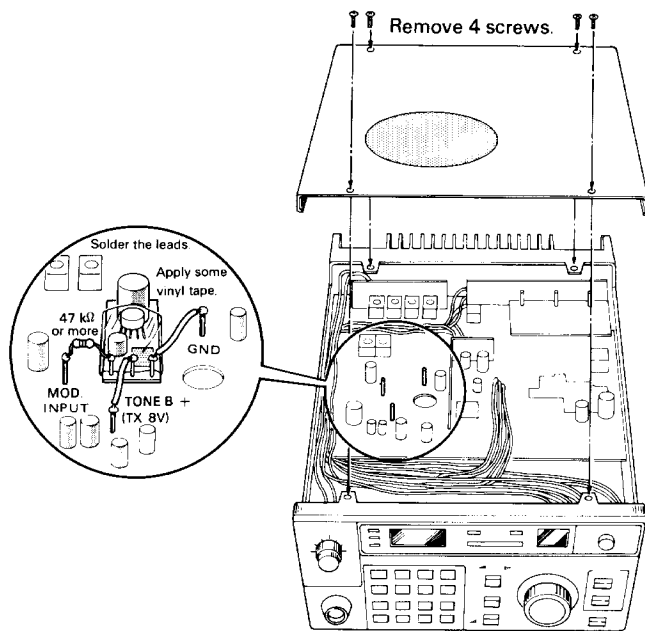

Fig. 3-1

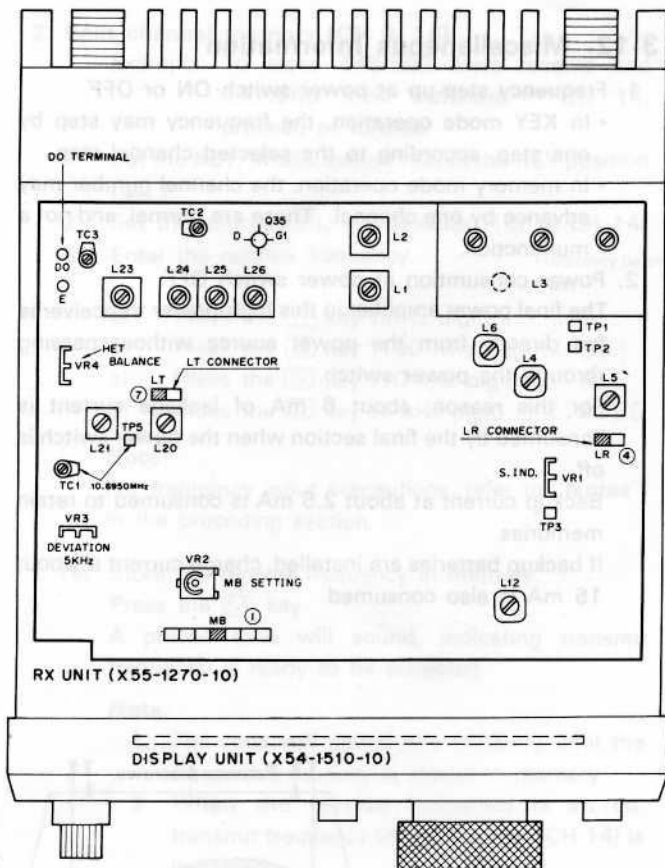

Fig. 3-3(A)

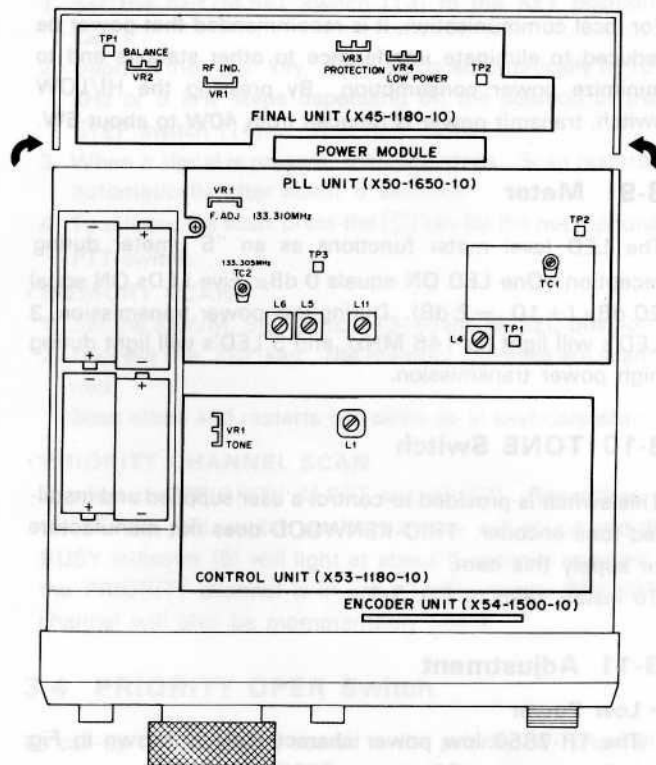

Fig. 3-3(B)

SECTION 5. OPTIONAL ACCESSORIES

The following accessories are available for more sophisticated operation of the TR-7850.

5-1 Fixed Station DC Power Supply KPS-12

The KPS-12 DC power supply perfectly matches the TR-7850's design. It incorporates a circuit for protecting the transceiver against shorted output and power supply overload.

5-2 External Speaker SP-40

Designed for mobile operation. Styling and tone quality match the TR-7850 perfectly.

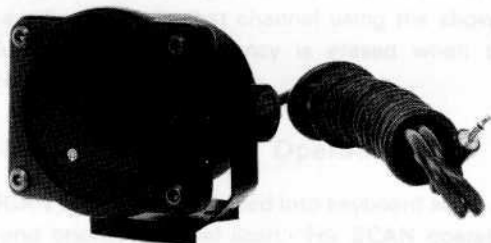

5-3 Charger BC-1

This charger is used as a Back-up power supply when the main power supply is off for extended periods.

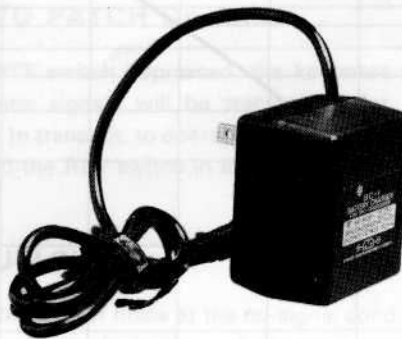

TR-7850 SCHEMATIC

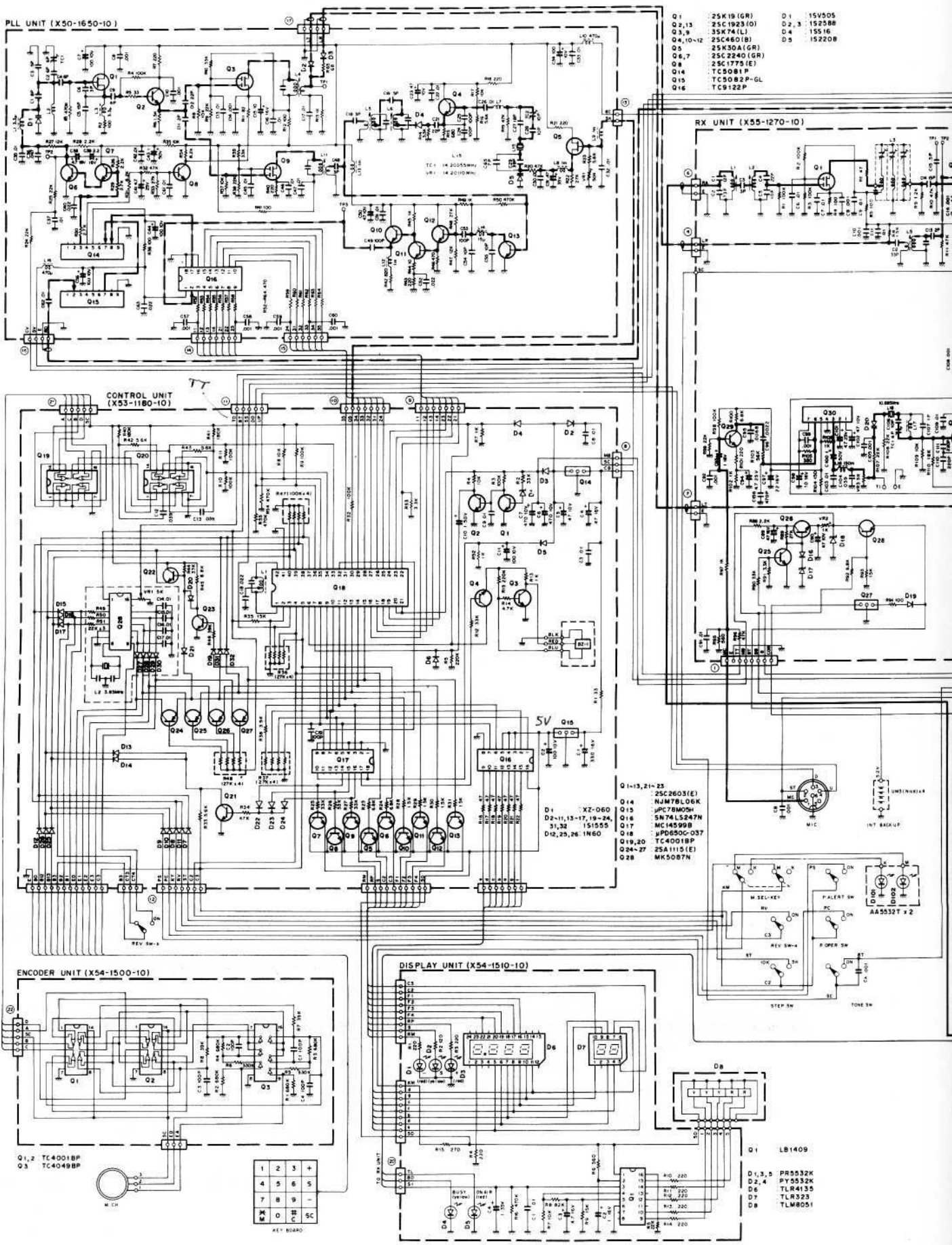

- Q1 : 25K19 (GR)
- Q2,13 : 25C1923 (O)
- Q3,9 : 35R74 (LL)
- Q4,10-12 : 25C460 (B)
- Q5 : 25K30A (GR)
- Q6,7 : 25C2240 (GR)
- Q8 : 25C1775 (E)
- Q14 : TC5081 P
- Q15 : TC5082 P-GL
- Q16 : TC9122 P
- D1 : 15V505
- D2,3 : 152388
- D4 : 15516
- D5 : 152208

- Q13,21-25 : 25C2603 (E)
- Q14 : NJM78L06K
- Q15 : μ PC78M05W
- Q16 : SR74LS247N
- Q17 : MC145998
- Q18 : μ PD650C-037
- Q19,20 : TC4001BP
- Q24-27 : 25A1110 (E)
- Q28 : MK5087N
- D1 : XZ-060
- D2-11,13-17,19-24,31,32 : 151555
- D12,25,26 : 1N60

- Q1 : LB1409
- D1,3,5 : PR5532K
- D2,4 : PY5532K
- D6 : TR4135
- D7 : TLR928
- D8 : TLM8051

1	2	3	+
4	5	6	5
7	8	9	-
0	+	SC	

REV. B0480

CHEMATIC DIAGRAM

BLOCK DIAGRAM

- | | | | | | | | |
|-------|--------|------------------------|------------|---------|--------------|----------------------|--------|
| D1 | 15V50S | Q1, 2, 35 | 35K74(L) | Q29 | 25C2240(GR) | D1, 2, 7-10 | 1N60 |
| D2, 3 | 15Z58B | Q3-11, 31, 32 | 25C460(B) | Q30 | TAT061AP | D3-6, 12, 14, 16, 25 | 151555 |
| D4 | 15516 | Q12, 13 | 25C1775(E) | Q33, 34 | 25K61(GR) | D11 | 151212 |
| D5 | 15Z20B | Q14-16, 18, 19, 25, 26 | 25C1815(Y) | Q36 | 25C2538-22-A | D18 | XZ-06B |
| | | Q17, 28 | 25A1015(Y) | | | D17 | XZ-070 |
| | | Q18 | NA1366W | | | D18 | XZ-070 |
| | | Q21, 27 | μPC78M08H | | | D19 | V06B |
| | | Q23 | 25A496(Y) | | | Q20, 31 | 15Z20B |
| | | Q24 | 25C496(Y) | | | D13, 22-24 | 1T7410 |

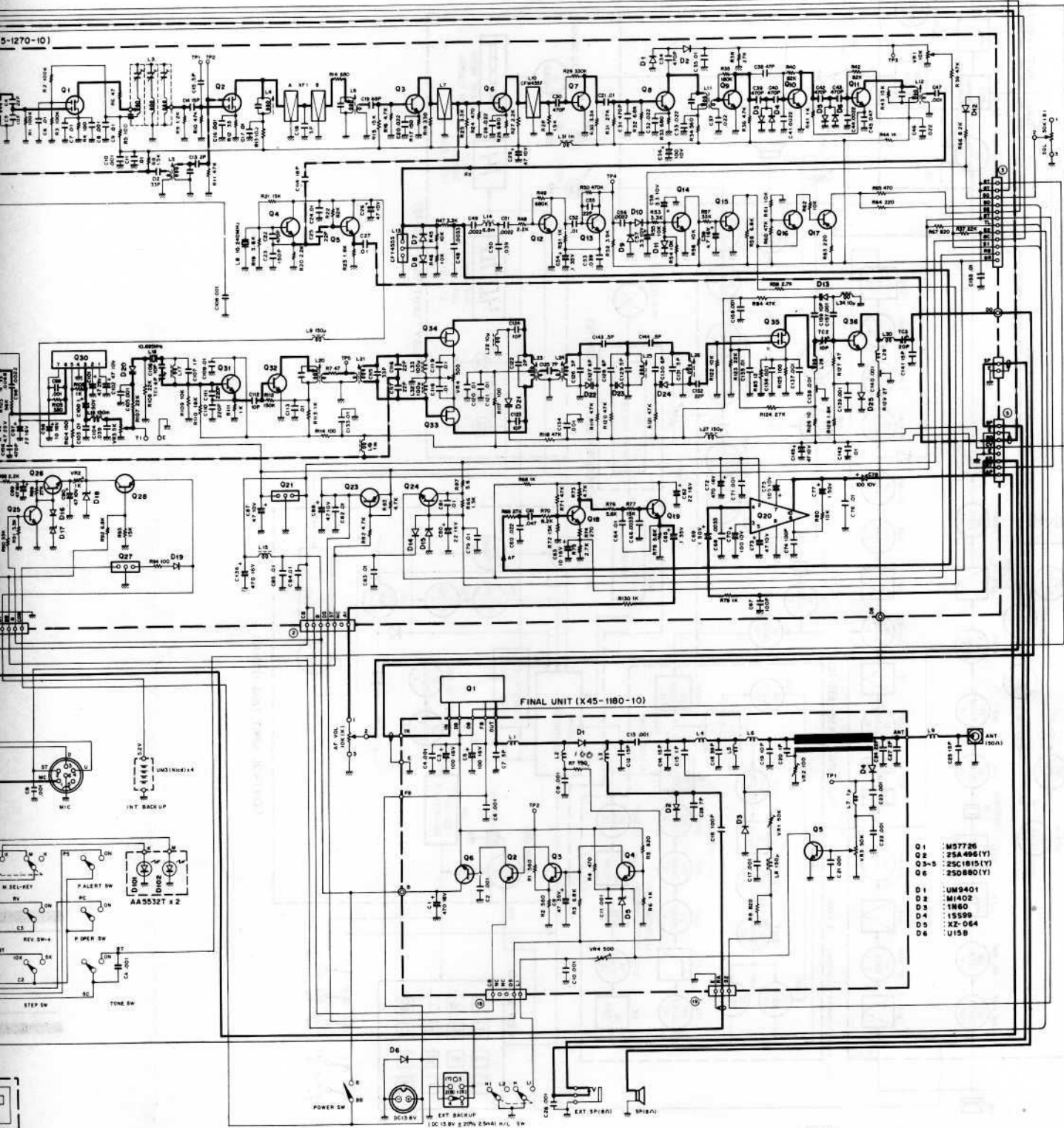

- | | |
|-------|---------|
| Q1 | LB1409 |
| D1, 3 | PR5532K |
| D2, 4 | PY5532K |
| D6 | TLR4135 |
| D7 | TLR323 |
| D8 | TLR8051 |

MHY M57726 MODULE

TR-7850 (K)

BLOCK DIAGRAM

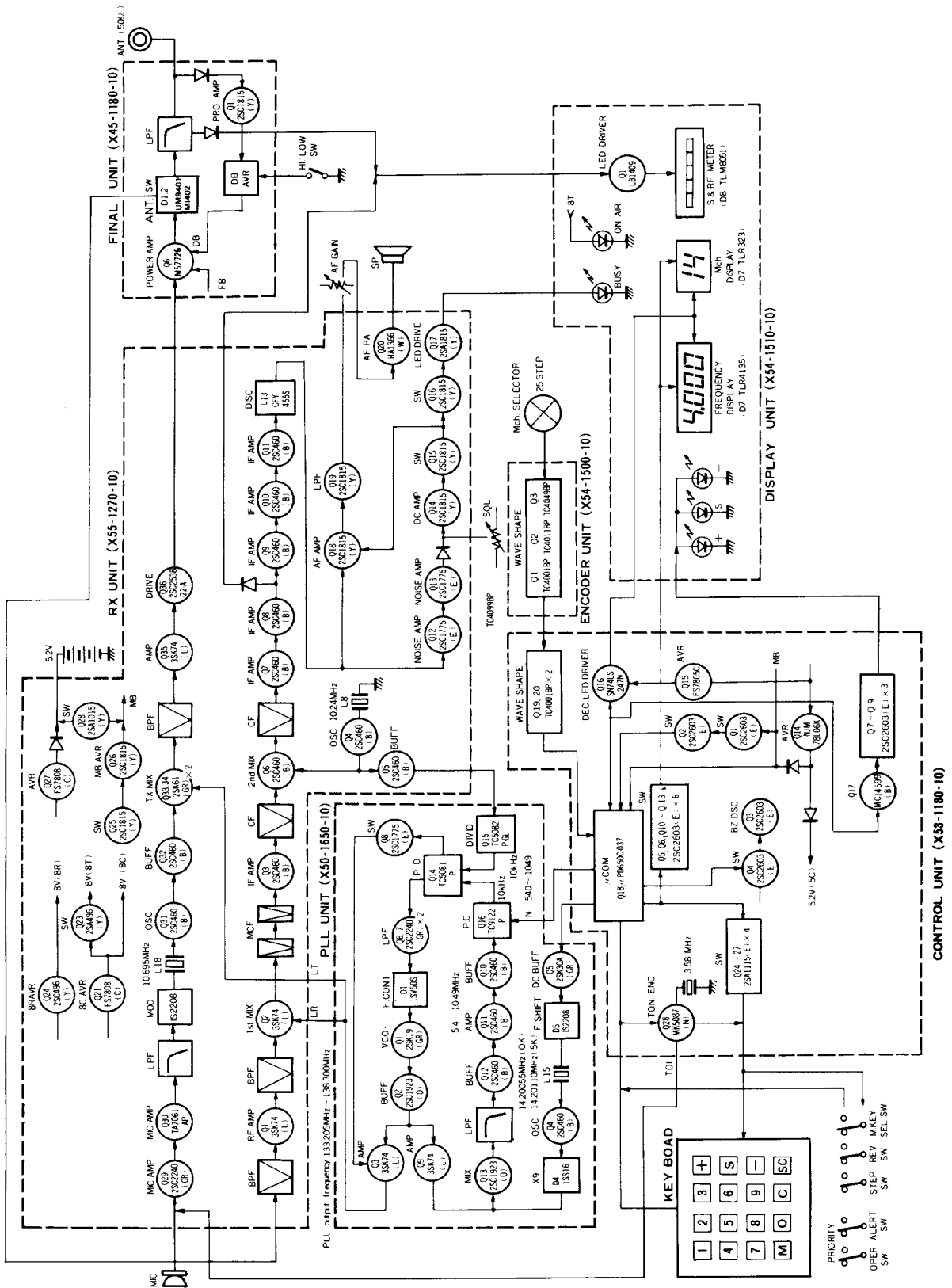

TR 7800
S/N 1110048
A. J. [unclear] [unclear]

Model TR-7850

Serial No. 1110048

Date of Purchase 3 / 14 / 91

Dealer Ray Dalton

WRTR

(WILFEN)

A product of
TRIO-KENWOOD CORPORATION
17-5, 2-chome, Shibuya, Shibuya-ku, Tokyo, 150, Japan

TRIO-KENWOOD COMMUNICATIONS, INC.
1111, West Walnut Street, Compton, California, 90220, U S A
TRIO-KENWOOD COMMUNICATIONS, GmbH
D 6374 Steinbach TS, Industriestrasse 8A, West Germany
TRIO-KENWOOD(AUSTRALIA)PTY. LTD.
30 Whiting Street, Artarmon, Sydney N S W Australia 2064

TR-7850 SCHEMATIC DIAGRAM

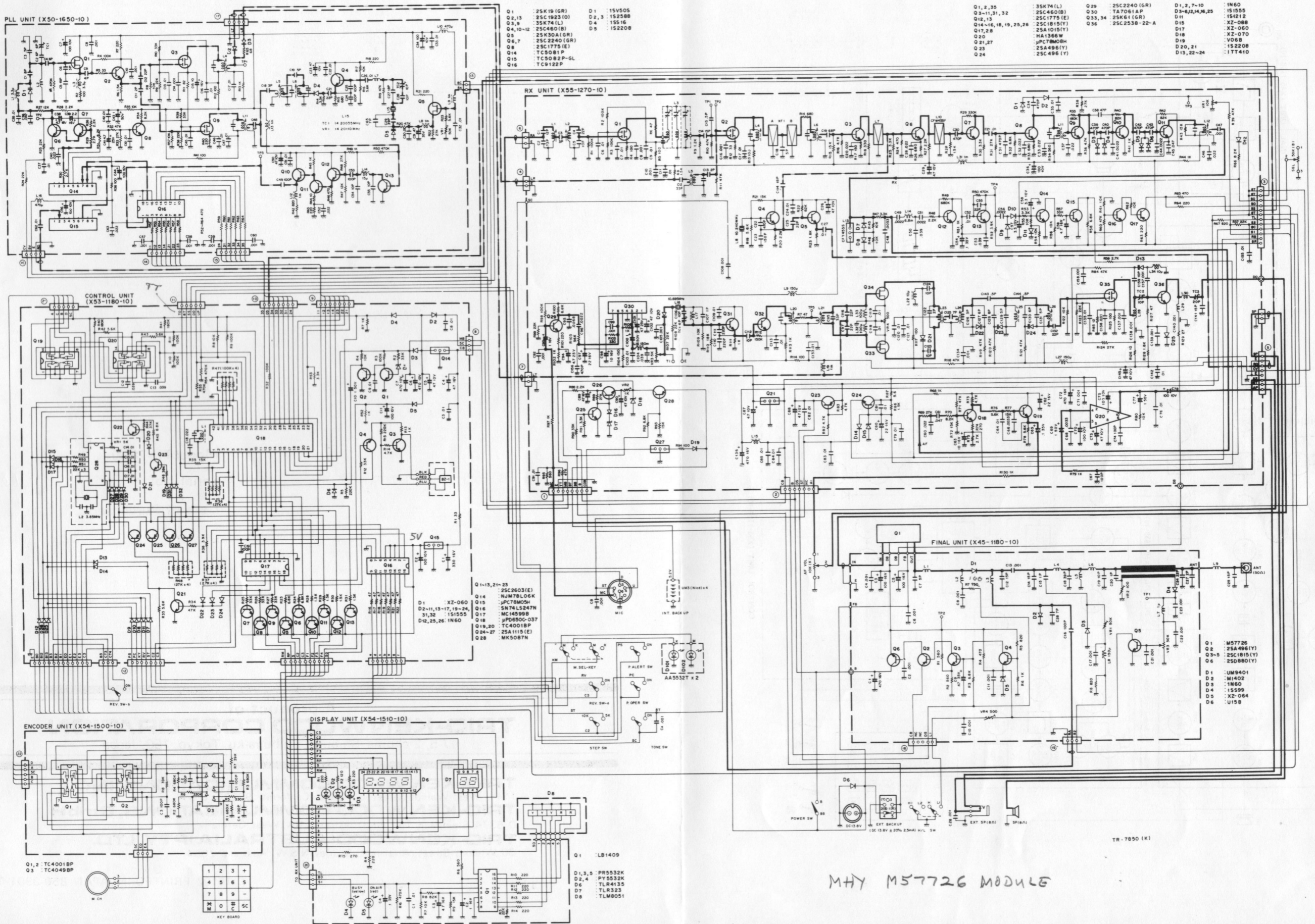

Q1	: 25K19 (GR)	D1	: 15V505
Q2,13	: 25C1923 (O)	D2,3	: 152588
Q3,9	: 35K74 (L)	D4	: 15516
Q4,10,12	: 25C460 (B)	D5	: 152208
Q5	: 25K30A (GR)		
Q6,7	: 25C2240 (GR)		
Q8,11	: 25C1775 (E)		
Q14	: TC5081 P		
Q15	: TC5082 P-GL		
Q16	: TC9122 P		

Q1,2,35	: 35K74 (L)	Q29	: 25C2240 (GR)	D1,2,7-10	: 1N60
Q3-11,31,32	: 25C460 (B)	Q30	: TA7061 A P	D11	: 151555
Q12,13	: 25C1775 (E)	Q33,34	: 25K61 (GR)	D12,12	: 151212
Q14-16,18,19,25,26	: 25C1815 (Y)	Q36	: 25C2538-22-A	D15	: XZ-088
Q17,28	: 25A1015 (Y)			D17	: XZ-060
Q20	: HA1366 W			D18	: XZ-070
Q21,27	: JPC78M05H			D19	: V058
Q23	: 25A496 (Y)			D20,21	: 152208
Q24	: 25C496 (Y)			D13,22-24	: 1T7410

Q11-13,21-23	: 25C2603 (E)
Q14	: NJM78L06K
Q15	: JPC78M05H
Q16	: SN74LS247N
Q17	: MC14559B
Q18	: JPD650C-037
Q19,20	: TC4001BP
Q24-27	: 25A1115 (E)
Q28	: MK5087N

Q1	: M57726
Q2	: 25A496 (Y)
Q3-5	: 25C1815 (Y)
Q6	: 25D80 (Y)
D1	: UM9401
D2	: M1402
D3	: 1N60
D4	: 15599
D5	: XZ-064
D6	: U158

Q1	: LB1409
D1,3,5	: PR5532K
D2,4	: PV5532K
D6	: TLR4135
D7	: TLR323
D8	: TLM8051

MHY M57726 MODULE