

5-6. BLOCK DIAGRAM

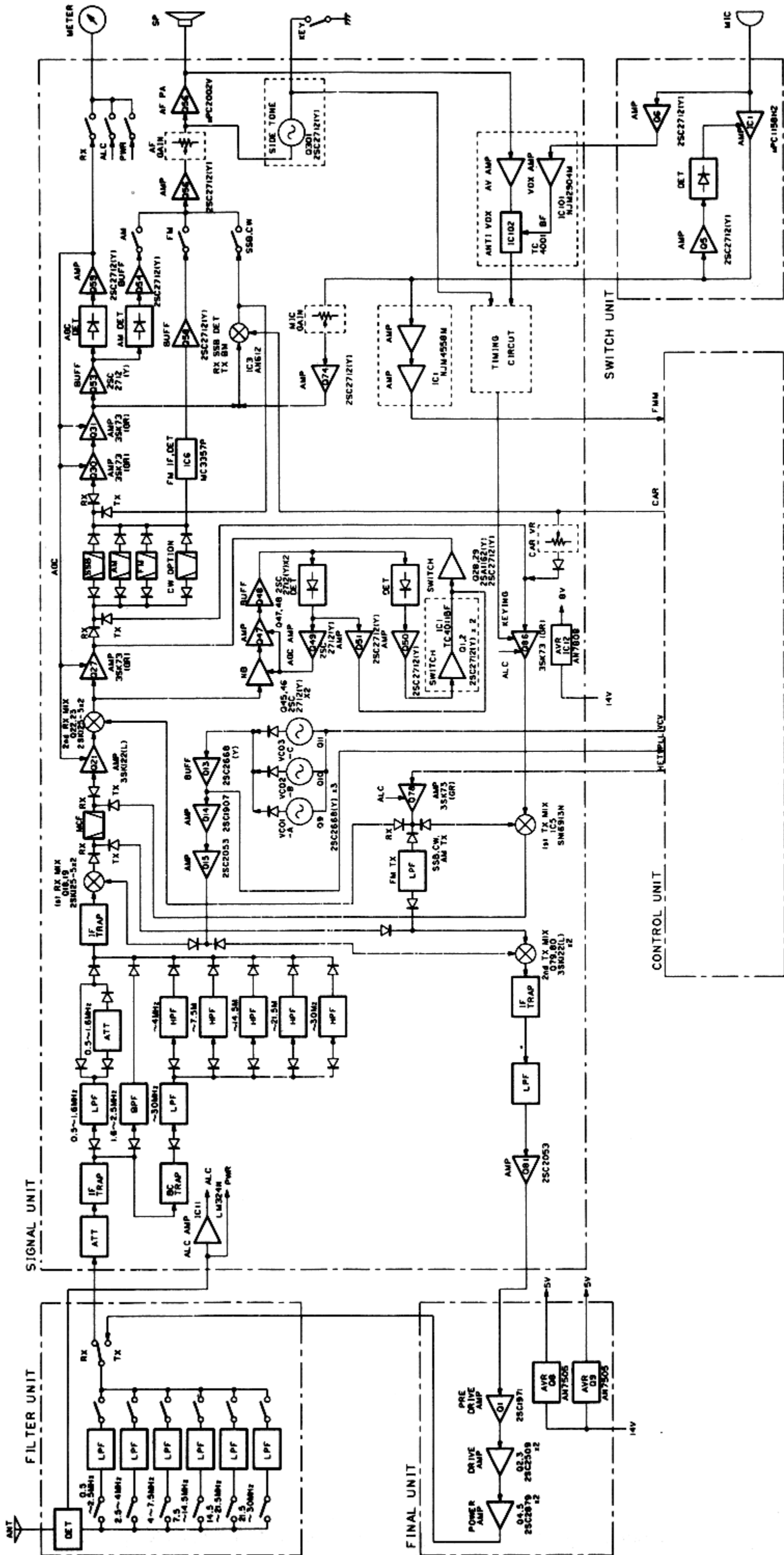

Note: Block Diagram is subject to change without notice.
 downloaded by Amateur Radio Directory www.hamdirectory.info

5-5. CIRCUIT DIAGRAM

■ SCHEMATIC DIAGRAM

Amateur Radio Directory
 Firma non verificata

Firmato digitalmente da
 Amateur Radio Directory
 ND: cn=Amateur Radio Directory,
 o=ARD, c=IT
 Data: 2002.11.10 16:43:03 +0100

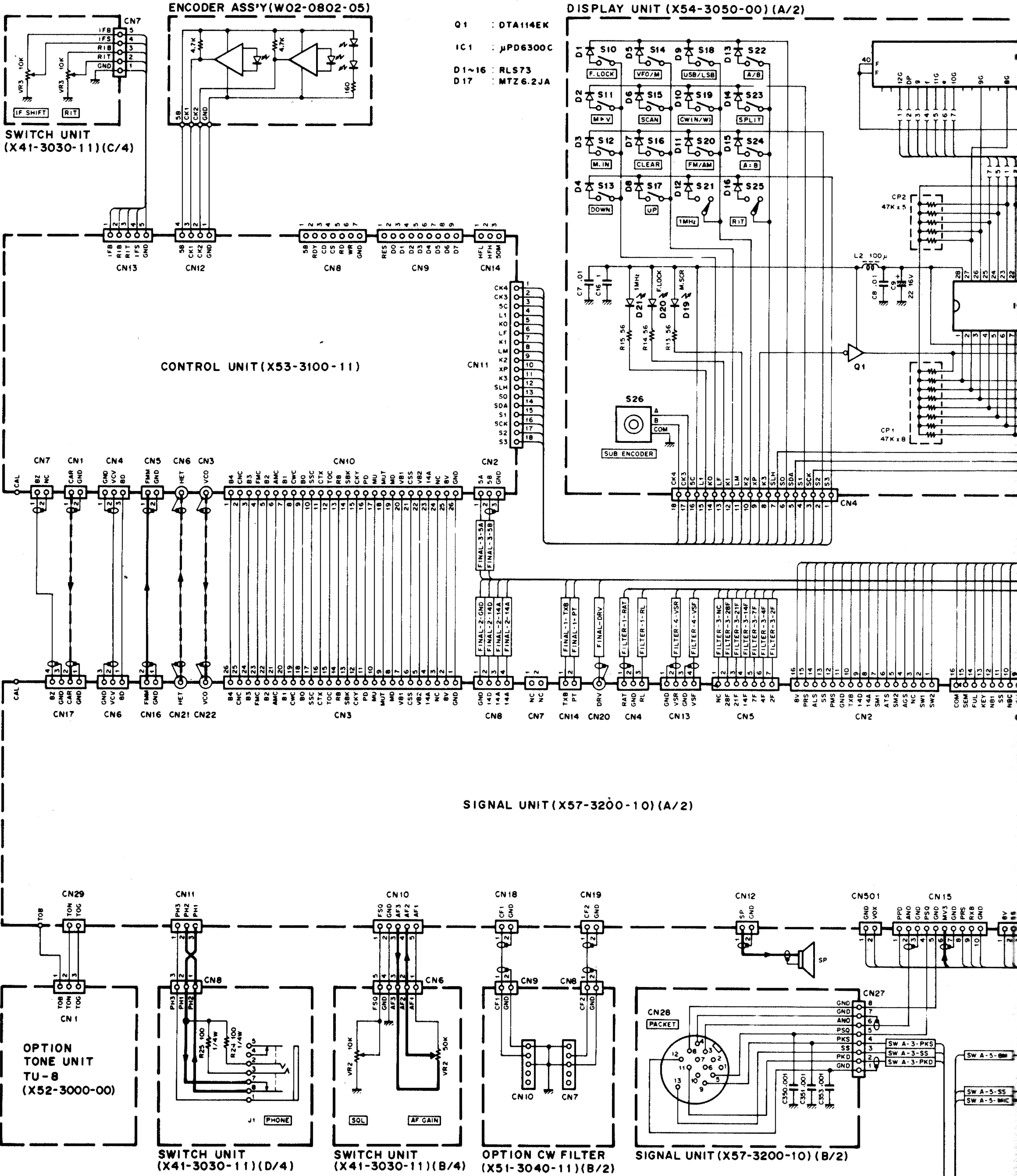

FILTER UNIT (X51-3040-11) (A/2)

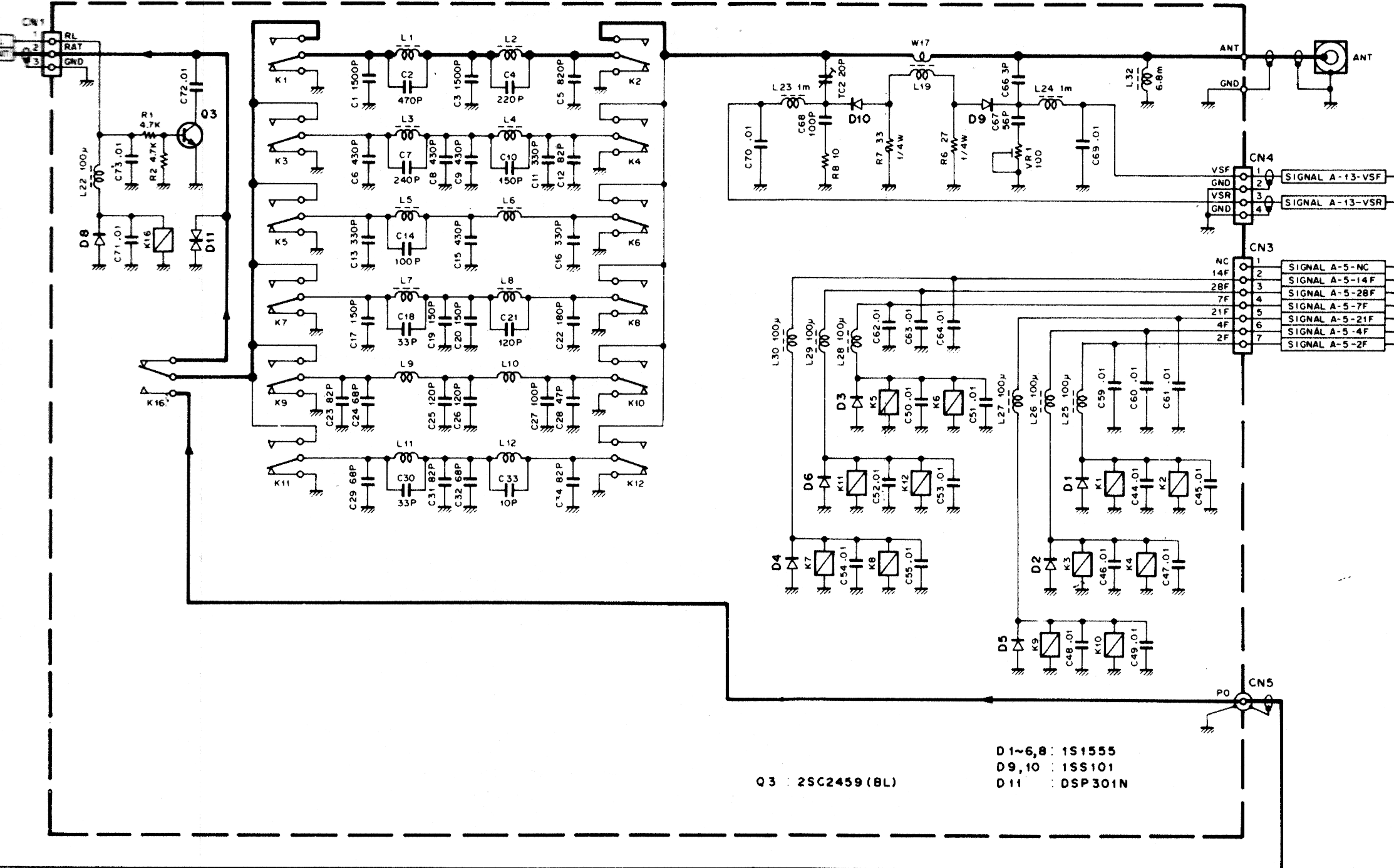

100W FINAL UNIT (X45-3100-11)

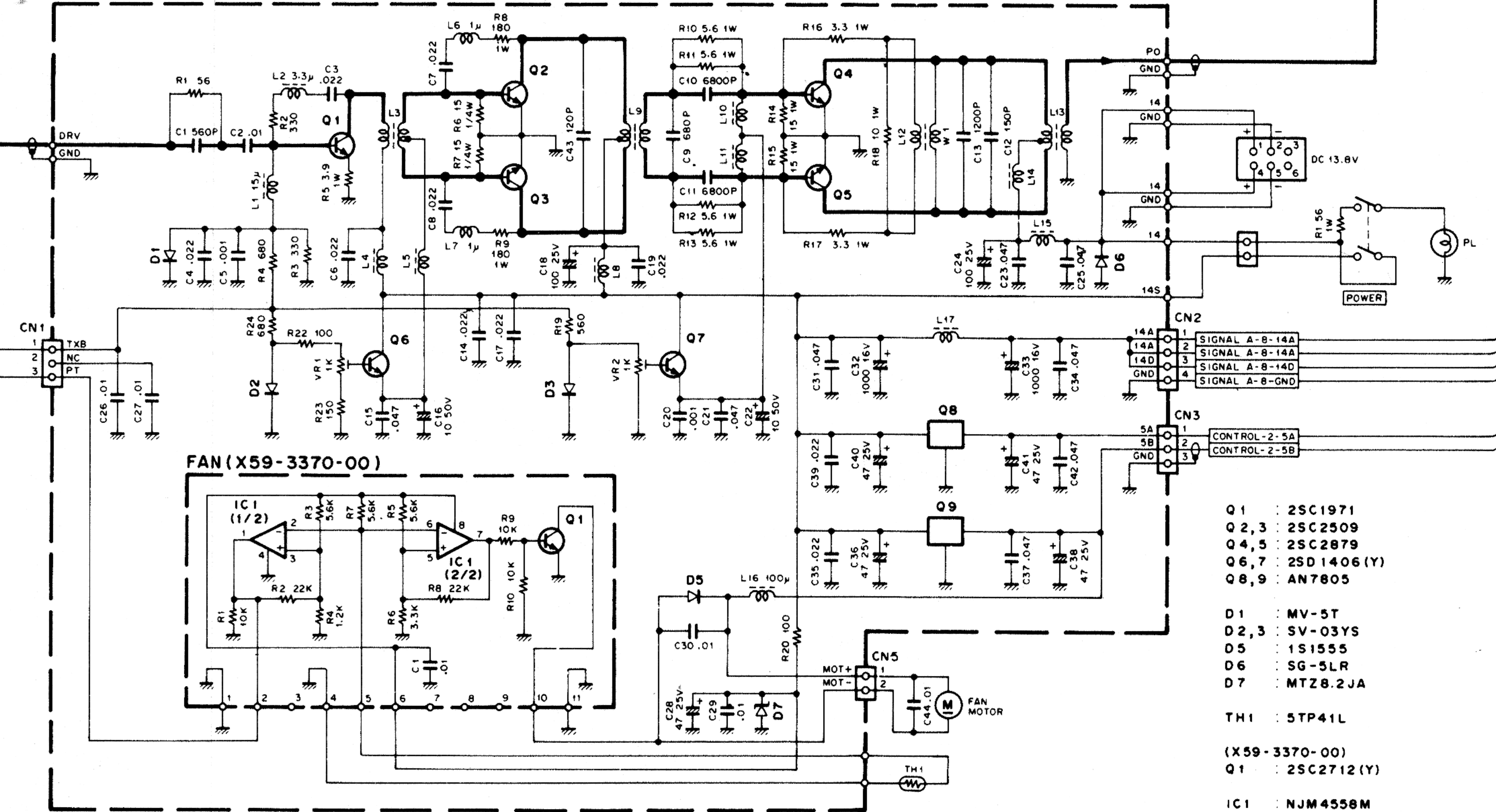

Note:

Circuit Diagram is subject to change without notice due to advancements in technology.

SIGNAL UNIT (X57-3200-10)

SIGNAL UNIT (X57-3200-10)

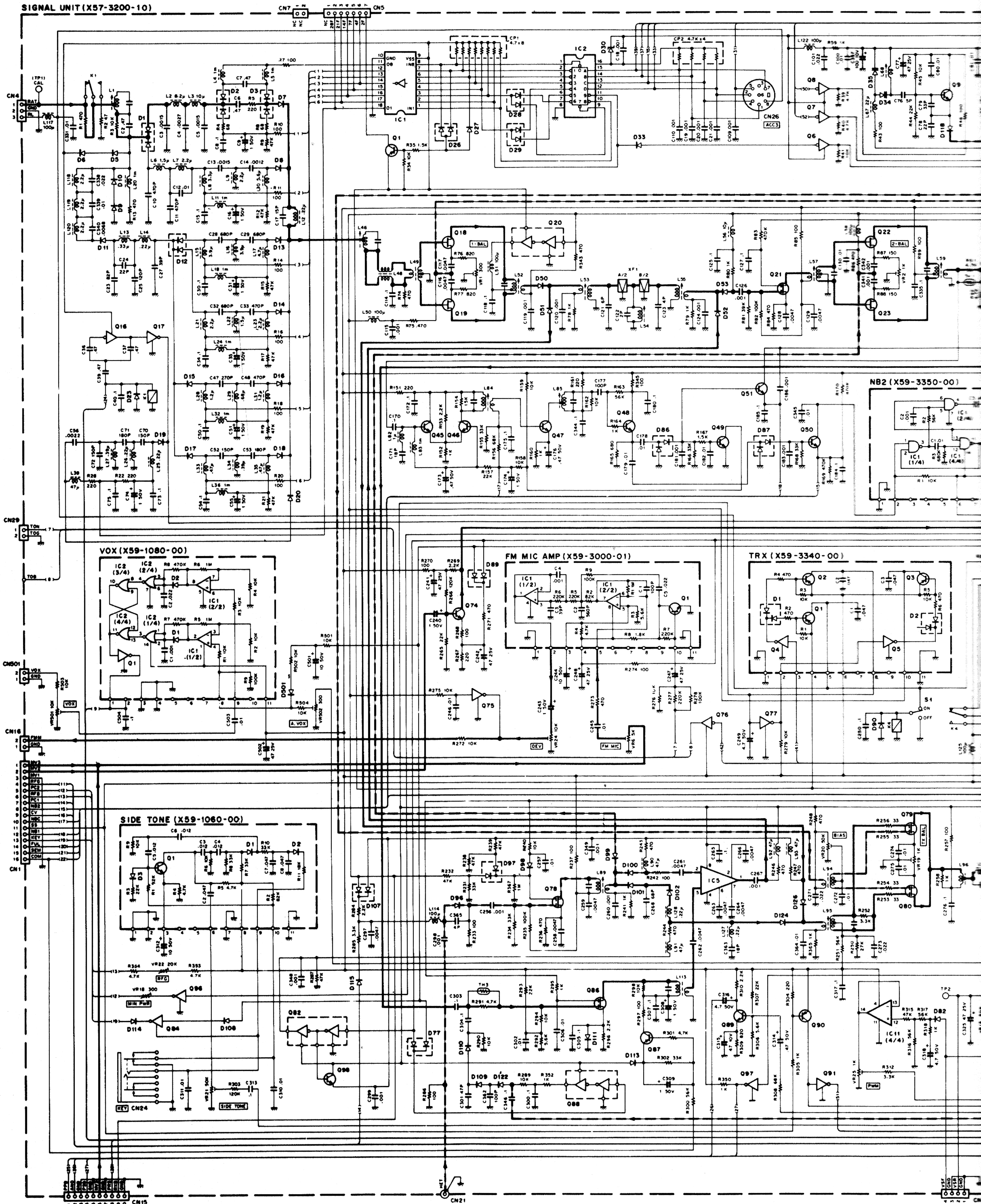

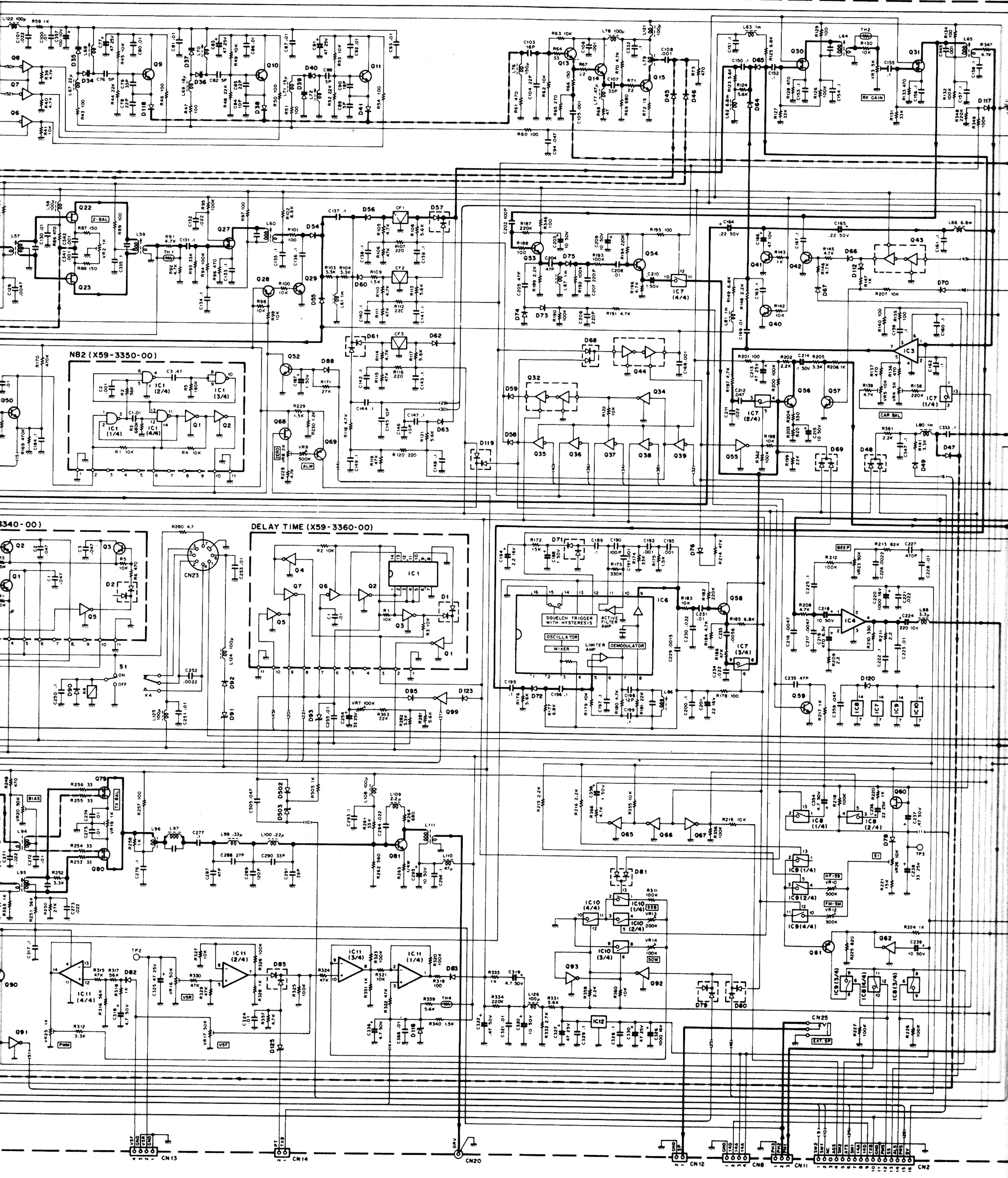

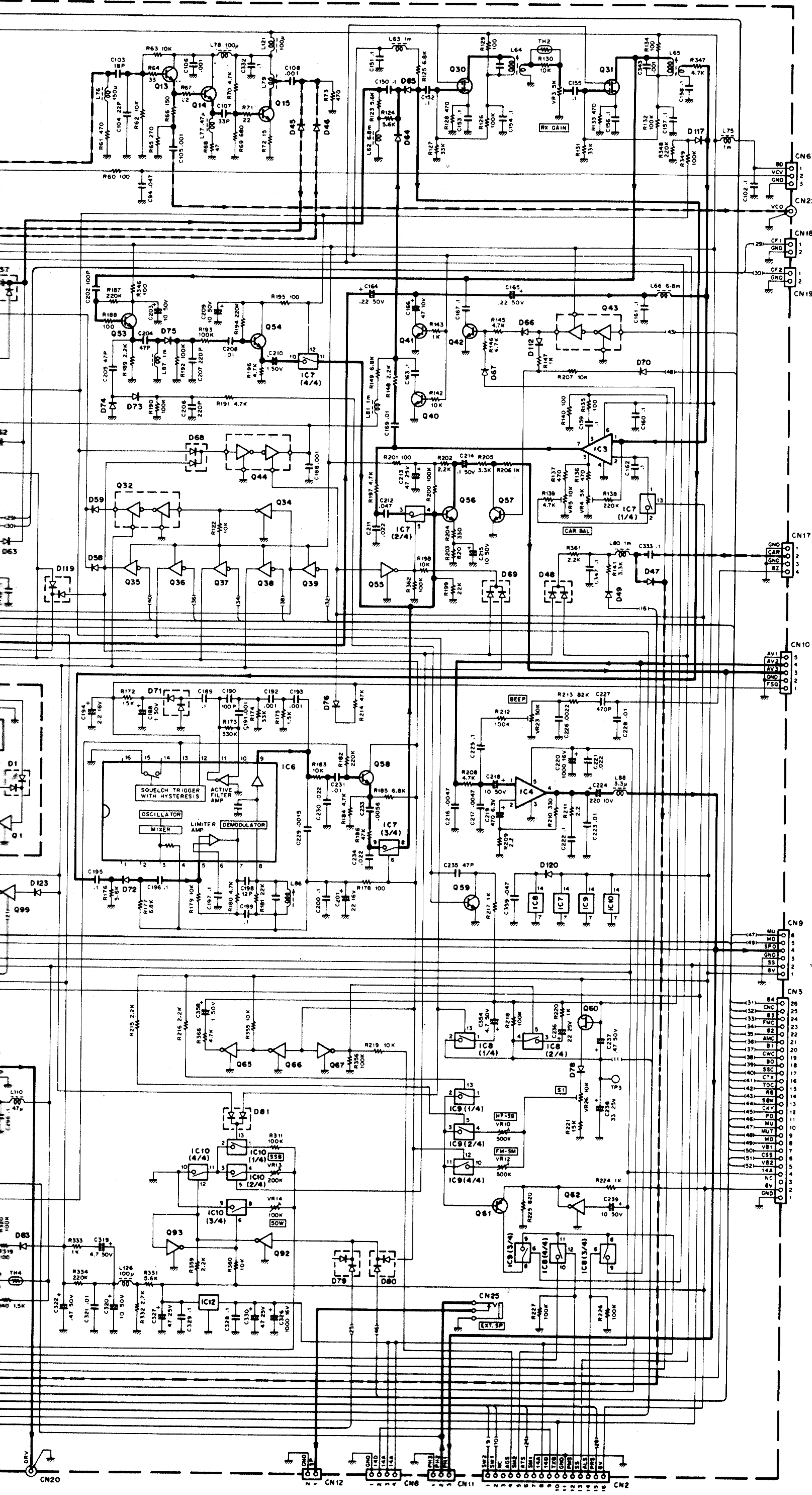

- (X57-3200-10)
- Q1,28,61,69,87,90 : 2SA1162(Y)
- Q17,34,55,65~67,75,77,84,91,92,96,97,99 : DTC114EK
- Q6~8,35~39,76 : DTA143EK
- Q9~11,13 : 2SC2668(Y)
- Q14 : 2SC1907
- Q15,81 : 2SC2053
- Q16 : DTA114EK
- Q18,19,22,23 : 2SK125-S
- Q20,32,43,44,82,88 : PMC3
- Q21,79,80 : 3SK122(L)
- Q27,30,31,78,86 : 3SK73(BR)
- Q29,40~42,45~54,56~59,74,89,98 : 2SC2712(Y)
- Q60,68 : 2SK192A(Y)
- Q62,93 : DTC114TK
- IC1 : M54581P
- IC2 : M74LS145P
- IC3 : AN612
- IC4 : JPC2002V
- IC5 : SN16913P
- IC6 : MC3357P
- IC7~10 : TC4066BP
- IC11 : LM324N
- IC12 : AN7808
- D1~3,12 : DAN235K
- D5,10 : US1090
- D6,9 : V08(O)
- D7,8,11,13~20,38,41,45,46,50~53,99~102,109,110,118,122,124,126 : RLS135
- D23,90 : 1S1555
- D48,57,61,68,69,77,79~81,85,89,97,107,119 : DAN202K
- D26,28,29 : DAP202K
- D27,33,49,54~56,58~60,62~67,70,72~74,76,78,83,88,92,95,98,108,112~115,117,120,123,501,502 : RLS73
- D30,93,503 : UZ-3.08
- D34~37,39,40 : ITT310TE
- D47,96 : M1204
- D71,75,82,86,87 : HSM88AS
- D91 : MTZ9-1J8
- D111 : KB-369
- D116,125 : RLZ3.6B
- TH1~4 : 112-502-2
- (X59-1060-00)
- Q1 : 2SC2712(Y)
- D1,3 : DAN202K
- D2 : DAP202K
- (X59-1080-00)
- Q1 : 2SC2712(Y)
- IC1 : NJM2904M
- IC2 : TC4001BF
- D1,2 : DAP202K
- (X59-3000-01)
- Q1 : 2SC2712(Y)
- IC1 : NJM4558M
- (X59-3340-00)
- Q1,2 : 2SA1204(Y)
- Q3 : 2SA1182(Y)
- Q4,5 : DTC114EK
- D1,2 : DAN202(K)
- (X59-3350-00)
- Q1,2 : DTC114EK
- IC1 : TC4011BF
- (X59-3360-00)
- Q1~5 : DTC114EK
- Q6 : DTA114EK
- Q7 : DTC114TK
- D1 : DAN202(K)

Note: Circuit Diagram is subject to

CONTROL UNIT (X53-3100-11)

CONTROL UNIT (X53-3100-11)

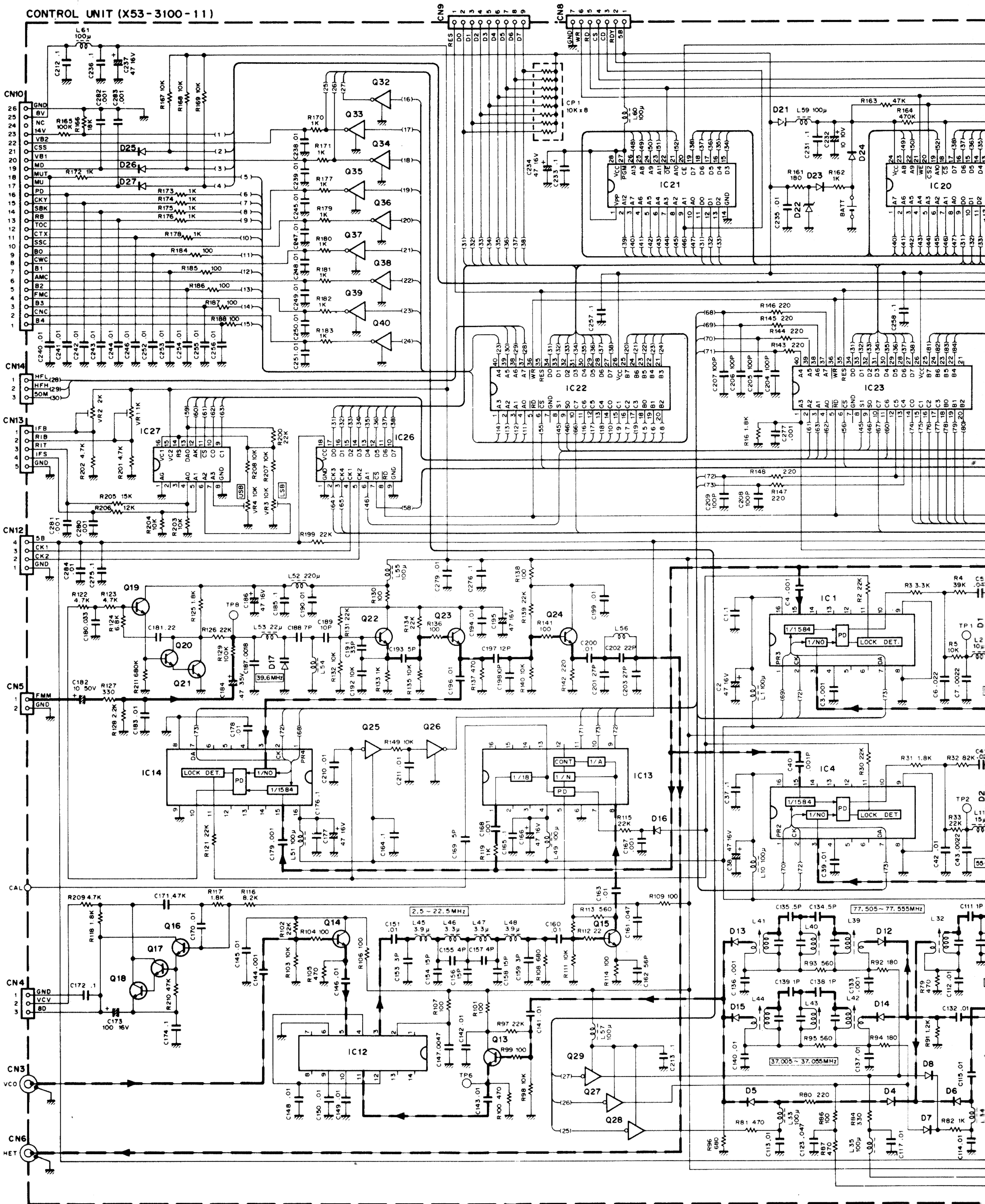

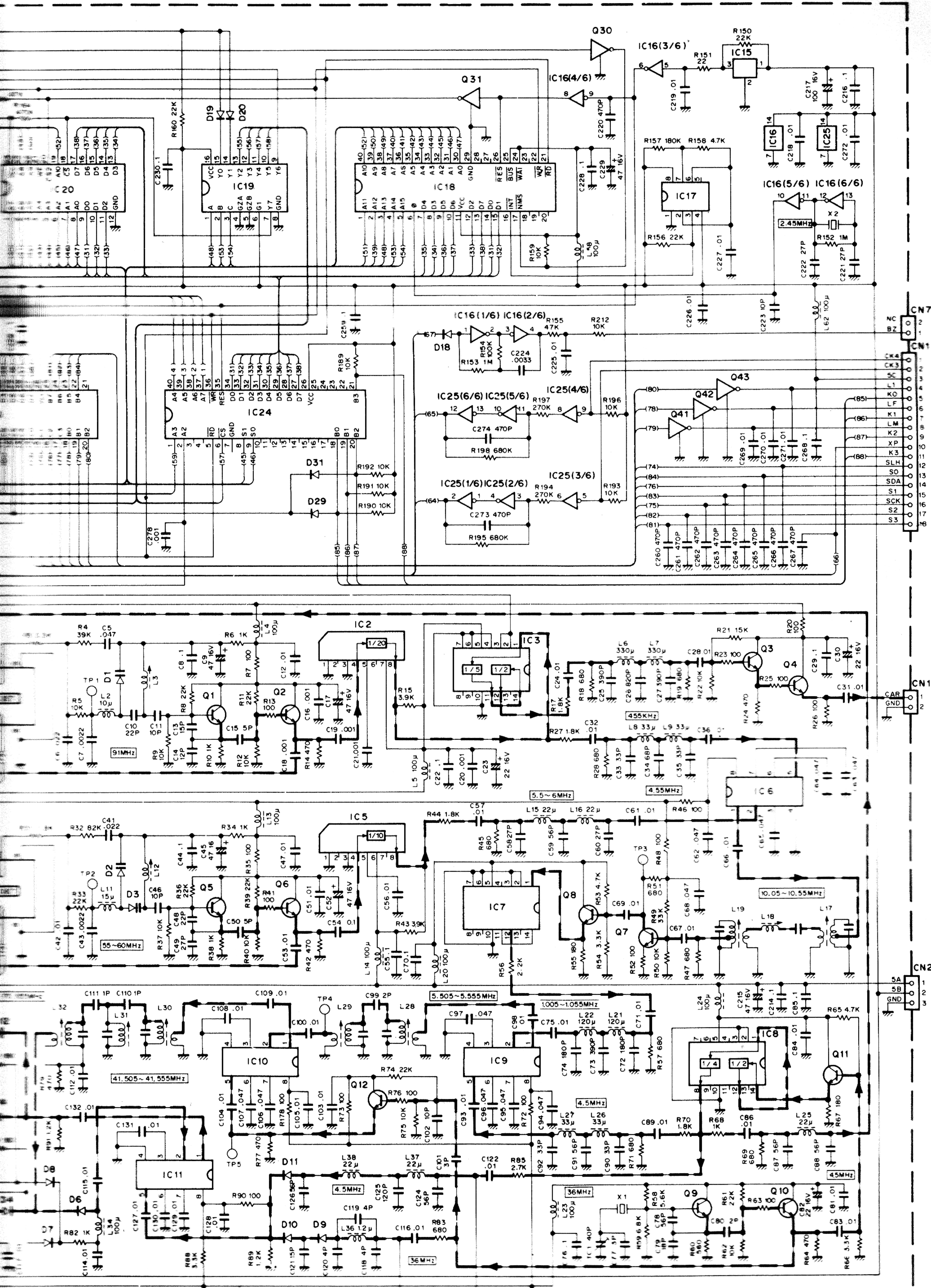

- D1 : 1SV55A
- D2,3 : 1TTS10T
- D4,6 : RLS135
- D7,8,16 : RLS73
- D9,21 : 23
- D22 : 1SV153
- D23,27 : UZ3.38CA
- D29,31 : ISS133
- IC1,4,14 : M54927P
- IC2 : M54459L
- IC3 : SN74LS90N
- IC5 : M54460L
- IC6,9,10,11 : SN16913P
- IC8 : M74LS93P
- IC12 : SN76514N
- IC13 : MB87006A
- IC15 : PST520D
- IC16,25 : TC4069UBP
- IC17 : ME555C or NE555P
- IC18 : BU18400A
- IC19 : SN74LS138N
- IC20 : MBM27C128-25JA
- IC21 : MBM27C128-25JA
- IC22 ~ 24 : TMP8255AP-5
- IC26 : LZ92K37
- IC27 : MB4052
- Q1,2,5,6 : 2SC2668(Y)
- Q10 ~ 15 : 22 ~ 24
- Q3,7,8 : 2SC2458(Y)
- Q4 : 2SC1959(Y)
- Q9 : 2SC2787(L)
- Q16 ~ 21 : 2SC2459(BL)
- Q25 : DTA124ES
- Q26 : DTC124ES
- Q27 ~ 29 : DTA143ES
- Q30 ~ 40 : DTC144WS
- Q41 ~ 43 : DTC143TS