

KENWOOD

Document Copyrights

Copyright 2006 by Kenwood Corporation. All rights reserved.

No part of this manual may be reproduced, translated, distributed, or transmitted in any form or by any means, electronic, mechanical, photocopying, recording, or otherwise, for any purpose without the prior written permission of Kenwood.

Disclaimer

While every precaution has been taken in the preparation of this manual, Kenwood assumes no responsibility for errors or omissions. Neither is any liability assumed for damages resulting from the use of the information contained herein. Kenwood reserves the right to make changes to any products herein at any time for improvement purposes.

ALL MODE MULTI-BAND TRANSCEIVER

TS-2000/B2000/2000X TS-2000S/V/SX/VX

SERVICE MANUAL SUPPLEMENT II

KENWOOD

Kenwood Corporation

© 2006-9 PRINTED IN JAPAN
B51-8773-00 (N) 288

TS-2000/2000X/2000S/2000V/2000SX/2000VX

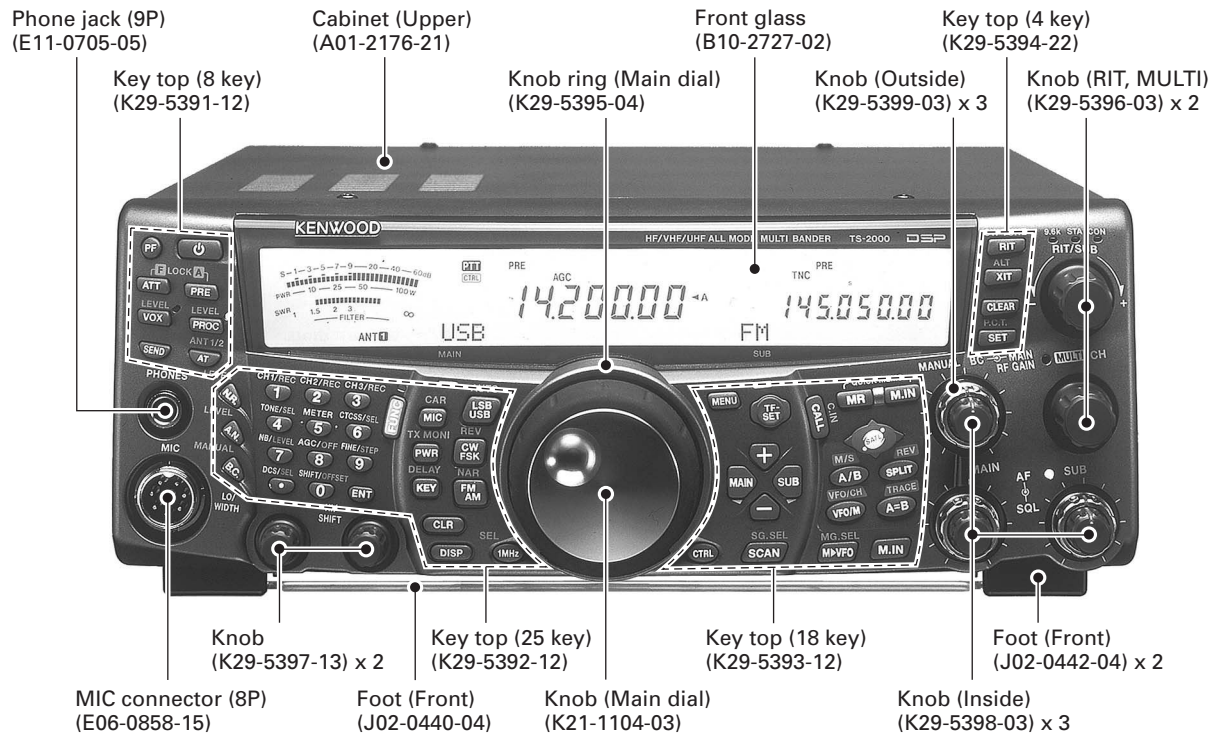

TS-B2000

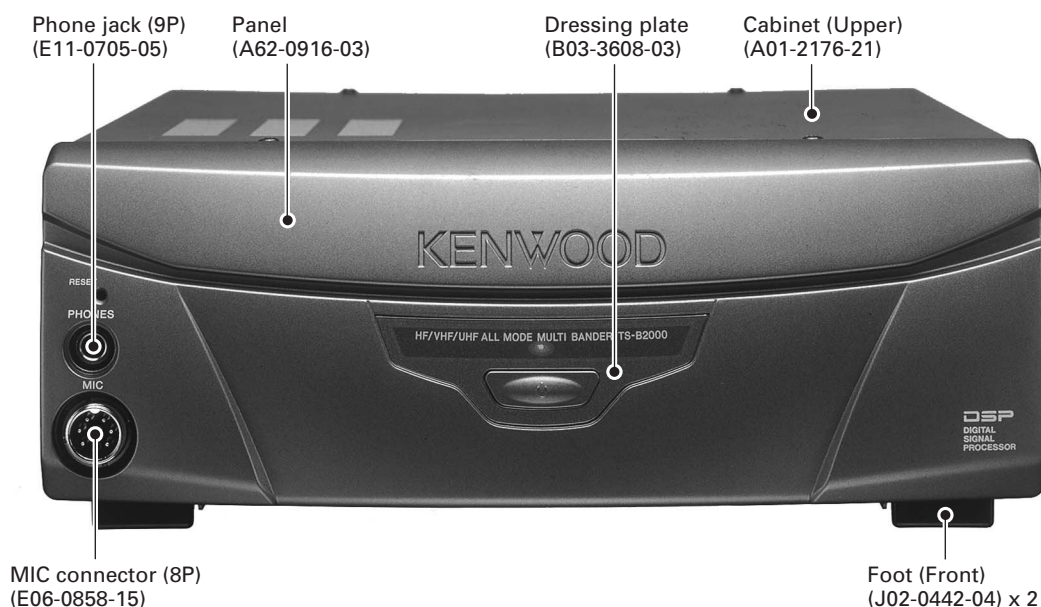

This product complies with the **RoHS** directive for the European market.

This product uses Lead Free solder.

CONTENTS

BEFORE USING THE SERVICE MANUAL	3
PARTS LIST	4
PC BOARD	
FINAL UNIT (X45-360X-XX)	57
FILTER UNIT (X51-315X-XX)	63
DISPLAY UNIT (X54-3320-00)	65
CONTROL UNIT (X53-391X-XX)	67
TX-RX 1 UNIT (X57-605X-XX)	71
TX-RX 2 UNIT (X57-606X-XX)	79
TX-RX 3 UNIT (UT-20) (X57-607X-XX)	89
SCHEMATIC DIAGRAM	
FINAL UNIT (X45-360X-XX)	93
FILTER UNIT (X51-315X-XX)	99
DISPLAY UNIT (X54-3320-00)	101
CONTROL UNIT (X53-391X-XX)	103
TX-RX 1 UNIT (X57-605X-XX)	107
TX-RX 2 UNIT (X57-606X-XX)	115
TX-RX 3 UNIT (UT-20) (X57-607X-XX)	123

BEFORE USING THE SERVICE MANUAL

- This service manual revises a board (RoHS) used with the TS-2000/TS-B2000/TS-2000X/TS-2000S/TS-2000V/TS-2000SX/TS-2000VX transceiver and issues it as a supplemental manual. Refer to the appropriate TS-2000 service manual for items which are not listed (TS-2000/X: B52-8558-00, TS-2000/TS-2000X/TS-B2000: B51-8622-00, TS-2000S/TS-2000V/TS-2000SX/TS-2000VX: B51-8545-00).
- Refer to the list below for the serial number of each transceiver with this service manual.
- Destination of the parts list/ PCB figures/ schematic diagrams of this service manual are the changes from the former service manual. Please read the following list, as they have been rearranged as shown in the list. Reference: TS-2000 (K)=K1

Model Name & Destination	Serial Numbers	Destination of Parts list/ PCB figures/ Schematic diagrams
TS-2000 (K)	80300001~	K1
TS-B2000 (K)	80300001~	K2
TS-2000X (K)	80300001~	K3
TS-2000 (E)	80300108~	E1
TS-B2000 (E)	-	E2
TS-2000 (E2)	80300061~	E3
TS-B2000 (E2)	-	E4
TS-2000X (E)	80300011~	E5
TS-2000S (J)	-	J
TS-2000V (J)	-	J1
TS-2000SX (J)	80600001~	J2
TS-2000VX (J)	-	J3

PARTS LIST

* New Parts. Δ indicates safety critical components.
Parts without **Parts No.** are not supplied.
Les articles non mentionnés dans le **Parts No.** ne sont pas fournis.
Teile ohne **Parts No.** werden nicht geliefert.

L : Scandinavia **K** : USA **P** : Canada
Y : PX (Far East, Hawaii) **T** : England **E** : Europe
Y : AAFES (Europe) **X** : Australia **M** : Other Areas

TS-2000/B2000/2000X/2000S/2000V/2000SX/2000VX (Y52-327X-XX)

Ref. No.	Address	New parts	Parts No.	Description	Destination	Ref. No.	Address	New parts	Parts No.	Description	Destination
TS-2000/B2000/2000X/2000S/2000V/2000SX/2000VX						17	2C		B72-1641-04	MODEL NAME-PLATE	K1
1	2A	*	A01-2176-21	CABINET (UPPER)		17	2C	*	B72-1642-14	MODEL NAME-PLATE	E1,E3
2	1D	*	A01-2177-21	CABINET (BOTTOM)		17	2C		B72-1735-04	MODEL NAME-PLATE	K2
3	2C	*	A10-4017-11	CHASSIS		17	2C	*	B72-1736-14	MODEL NAME-PLATE	E2,E4
4	1B	*	A11-0417-11	SUB CHASSIS		17	2C		B72-1878-04	MODEL NAME-PLATE	J2
5	1F	*	A22-2502-31	SUB PANEL	E3,E5,J	17	2C		B72-1879-04	MODEL NAME-PLATE	K3
5	1F	*	A22-2502-31	SUB PANEL	J1,J2,J3	17	2C		B72-1883-04	MODEL NAME-PLATE	J3
5	1F	*	A22-2502-31	SUB PANEL	K1,K3,E1	17	2C	*	B72-2072-04	MODEL NAME-PLATE	E5
5	2F	*	A22-2502-31	SUB PANEL	K2,E2,E4	19	2C		E04-0167-05	RF COAXIAL RECEPTACLE (M)	
6	2E		A62-0771-03	PANEL ASSY	E3,E5,J	20	2C		E04-0170-15	RF COAXIAL RECEPTACLE (N)	
6	2E		A62-0771-03	PANEL ASSY	J1,J2,J3	21	2I	*	E07-0751-15	DIN PLUG (7P) ACCESSORY	
6	2E		A62-0771-03	PANEL ASSY	K1,K3,E1	22	2I	*	E07-0851-15	DIN PLUG (8P) ACCESSORY	
6	2E		A62-0916-03	PANEL	K2,E2,E4	-			E07-0852-15	ROUND PLUG (MICROPHONE)	E1,E2,E3
147	2E		B03-3608-03	DRESSING PLATE	K2,E2,E4	-			E07-0852-15	ROUND PLUG (MICROPHONE)	E4,E5
7	1C		B09-0355-05	CAP (REAR-COM)		-			E07-0852-15	ROUND PLUG (MICROPHONE)	K1,K2,K3
8	2E	*	B10-2727-02	FRONT GLASS	E3,E5,J	24	2I	*	E07-1351-15	DIN PLUG (13P) ACCESSORY	E1,E2,E3
8	2E	*	B10-2727-02	FRONT GLASS	J1,J2,J3	24	2I	*	E07-1351-15	DIN PLUG (13P) ACCESSORY	E4,E5
8	2E	*	B10-2727-02	FRONT GLASS	K1,K3,E1	24	2I	*	E07-1351-15	DIN PLUG (13P) ACCESSORY	K1,K2,K3
10	1I	*	B42-7003-04	RATING LABEL (DC CORD)	E1,E2,E3	25	2C		E23-1164-04	EARTH LUG (ANT)	
10	1I	*	B42-7003-04	RATING LABEL (DC CORD)	E4,E5	26	1I		E30-3157-15	DC CORD ACCESSORY	
18	2E		B43-1222-04	BADGE (FRONT GLASS)	E3,E5,J	27	2C		E37-0866-05	FLAT CABLE (X57-605A CN26)	
18	2E		B43-1222-04	BADGE (FRONT GLASS)	J1,J2,J3	27	3C,2F		E37-0866-05	FLAT CABLE (X57-605B CN800)	K1,K3,E1
18	2E		B43-1222-04	BADGE (FRONT GLASS)	K1,K3,E1	27	3C,2F		E37-0866-05	FLAT CABLE (X57-605B CN800)	E3,E5,J
12	1J	*	B46-0310-13	WARRANTY CARD	E1,E2,E3	27	3C,2F		E37-0866-05	FLAT CABLE (X57-605B CN800)	J1,J2,J3
12	1J	*	B46-0310-13	WARRANTY CARD	E4,E5	28	1B		E37-0867-05	FLAT CABLE (X57-606B CN501)	
12	1J		B46-0469-20	WARRANTY CARD	K1,K2,K3	31	2B		E37-0870-05	FLAT CABLE (X57-606A CN12)	
13	1J		B52-0614-00	SCHEMATIC DIAGRAM	E1,E2,E3	32	1C		E37-0871-05	FLAT CABLE (X45A CN9)	
13	1J		B52-0614-00	SCHEMATIC DIAGRAM	E4,E5	33	2B		E37-0872-05	FLAT CABLE (X57-606A CN14)	
13	1J		B52-0614-00	SCHEMATIC DIAGRAM	K1,K2,K3	34	3B		E37-0873-05	LEAD WIRE (X45A CN203,+B)	
-			B52-0615-00	SCHEMATIC DIAGRAM	J,J1,J2	35	3B		E37-0874-05	LEAD WIRE (X45A CN204,GND)	
-			B52-0615-00	SCHEMATIC DIAGRAM	J3	-			E37-0875-05	LEAD WIRE (X57-606B CN502)	
14	1J		B52-0616-00	SCHEMATIC DIAGRAM	E1,E2,E3	-			E37-0876-05	LEAD WIRE (X57-606C CN506)	
14	1J		B52-0616-00	SCHEMATIC DIAGRAM	E4,E5	-			E37-0877-05	LEAD WIRE (X57-606A CN8,13)	
14	1J		B52-0616-00	SCHEMATIC DIAGRAM	K1,K2,K3	-			E37-0878-05	LEAD WIRE (X51 CN20,HF RX)	
15	1J		B52-0617-00	SCHEMATIC DIAGRAM	E1,E2,E3	-			E37-0879-05	LEAD WIRE (X45A CN1,HF TX)	
15	1J		B52-0617-00	SCHEMATIC DIAGRAM	E4,E5	-			E37-0880-05	LEAD WIRE (X57-606A CN6)	
15	1J		B52-0617-00	SCHEMATIC DIAGRAM	K1,K2,K3	-			E37-0881-05	LEAD WIRE (X45A CN2,14TX)	
148	1J	*	B52-0618-00	SCHEMATIC DIAGRAM	E1,E2,E3	-			E37-0882-05	LEAD WIRE (X51 CN21,14RX)	
148	1J	*	B52-0618-00	SCHEMATIC DIAGRAM	E4,E5	-			E37-0883-05	LEAD WIRE (X57-606A CN2,3)	
148	1J	*	B52-0618-00	SCHEMATIC DIAGRAM	K1,K2,K3	-		*	E37-0886-15	LEAD WIRE (X53 CN505)	
149	1J	*	B59-1777-20	PAMPHLET (R&TTE)	E1,E2,E3	-		*	E37-0887-15	LEAD WIRE (X53 CN503)	
149	1J	*	B59-1777-20	PAMPHLET (R&TTE)	E4,E5	-		*	E37-0888-15	LEAD WIRE (X57-606A CN9)	
-		*	B59-2307-00	PAMPHLET (FREQUENCY)	E5	-		*	E37-0889-05	LEAD WIRE (X57-605A CN31,32)	
16	1J	*	B62-1220-50	INSTRUCTION MANUAL (JAPANESE)	J,J1,J2	-		*	E37-0890-15	LEAD WIRE (X57-606A CN10)	
16	1J	*	B62-1220-50	INSTRUCTION MANUAL (JAPANESE)	J3	50	2C		E37-0891-05	LEAD WIRE (EXT AT)	
16	1J	*	B62-1221-30	INSTRUCTION MANUAL (ENGLISH)	E1,E2,E5	-			E37-0897-05	LEAD WIRE (X57-607 CN1)	J3
16	1J	*	B62-1221-30	INSTRUCTION MANUAL (ENGLISH)	K1,K2,K3	-		*	E37-0897-05	LEAD WIRE (X57-607 CN1)	K3,E5,J2
16	1J	*	B62-1222-10	INSTRUCTION MANUAL (FRENCH)	E1,E2,E5	-		*	E37-0898-15	LEAD WIRE (X57-607 CN5)	J3
16	1J	*	B62-1223-10	INSTRUCTION MANUAL (SPANISH)	E3,E4	-		*	E37-0898-15	LEAD WIRE (X57-607 CN5)	K3,E5,J2
16	1J		B62-1224-00	INSTRUCTION MANUAL (GERMAN)	E1,E2,E5	53	1B		E37-0946-05	FLAT CABLE (X57-606B CN533)	
16	1J		B62-1225-00	INSTRUCTION MANUAL (ITALIAN)	E1,E2,E5	54	3C		E37-0947-05	FLAT CABLE (X53 CN1)	
16	1J		B62-1226-00	INSTRUCTION MANUAL (DUTCH)	E1,E2,E5	55	2F		E37-0948-05	FLAT CABLE (X54 CN1)	E3,E5,J
17	2C		B72-1639-04	MODEL NAME-PLATE	J	55	2F		E37-0948-05	FLAT CABLE (X54 CN1)	J1,J2,J3
17	2C		B72-1640-04	MODEL NAME-PLATE	J1	55	2F		E37-0948-05	FLAT CABLE (X54 CN1)	K1,K3,E1
						-			E37-0951-05	LEAD WIRE (X51 CN4)	

PARTS LIST

TS-2000/B2000/2000X/2000S/2000V/2000SX/2000VX (Y52-327X-XX)

Ref. No.	Address	New parts	Parts No.	Description	Desti-nation	Ref. No.	Address	New parts	Parts No.	Description	Desti-nation
-			E37-0952-05	LEAD WIRE (X51 CN12,13)		87	1F	*	G10-1278-04	FIBROUS SHEET (SUB PANEL)	K1,K3,E1
-			E37-0953-05	LEAD WIRE (X57-606A CN18)		88	3D	*	G10-1281-04	FIBROUS SHEET (FLAT CABLE)	
-			E37-0957-05	LEAD WIRE (X51 CN10)		-		*	G10-1363-04	FIBROUS SHEET (FINAL UNIT)	
-			E37-0958-05	LEAD WIRE (X51 CN9)		-			G11-0609-04	CUSHION	E1,E2,E3
61	3B	*	E37-0959-15	LEAD WIRE (SP)		-			G11-0609-04	CUSHION	E4,E5
62	3C		E37-0963-05	FLAT CABLE (X57-607 CN6)	J3	-			G11-0609-04	CUSHION	K1,K2,K3
62	3C		E37-0963-05	FLAT CABLE (X57-607 CN6)	K3,E5,J2	98	2F		G11-2521-04	SHEET (PANEL ASSY)	E3,E5,J
-			E37-0971-05	LEAD WIRE (X57-605I CN961)	K2,E2,E4	98	2F		G11-2521-04	SHEET (PANEL ASSY)	J1,J2,J3
-			E37-0972-05	LEAD WIRE (X57-605I CN960)	K2,E2,E4	98	2F		G11-2521-04	SHEET (PANEL ASSY)	K1,K3,E1
29	3C	*	E37-1346-05	FLAT CABLE (X53 CN6)		89	3C		G11-2588-04	RUBBER SHEET (CHASSIS FRONT)	
30	1C	*	E37-1348-05	FLAT CABLE (X53 CN504)		90	1I		G11-2698-04	SHEET (ACCESSORY)	
-		*	F01-1043-04	RADIATION PLATE		91	2F	*	G11-4035-04	SHEET (KEY TOP)	E3,E5,J
67	1C		F07-1849-05	COVER (REAR PANEL)		91	2F	*	G11-4035-04	SHEET (KEY TOP)	J1,J2,J3
68	1C		F09-0453-05	CAP (REAR-DIN)		91	2F	*	G11-4035-04	SHEET (KEY TOP)	K1,K3,E1
69	3C	*	F09-0471-15	FANMOTOR		92	2F	*	G11-4036-04	SHEET (KEY TOP)	E3,E5,J
70	2B		F10-2328-02	SHIELDING PLATE		92	2F	*	G11-4036-04	SHEET (KEY TOP)	J1,J2,J3
71	2B	*	F10-2330-13	SHIELDING COVER (AT)		92	2F	*	G11-4036-04	SHEET (KEY TOP)	K1,K3,E1
72	3B		F10-2366-03	SHIELDING PLATE (1.2G)	J3	93	2F	*	G11-4037-14	SHEET (KEY TOP)	E3,E5,J
72	3B		F10-2366-03	SHIELDING PLATE (1.2G)	K3,E5,J2	93	2F	*	G11-4037-14	SHEET (KEY TOP)	J1,J2,J3
73	2B		F10-2398-04	SHIELDING COVER (X51)		93	2F	*	G11-4037-14	SHEET (KEY TOP)	K1,K3,E1
74	3G		F12-0463-04	SHIELDING SHEET		94	2F	*	G11-4038-04	SHEET (KEY TOP)	E3,E5,J
-			F15-0700-04	SHIELDING PLATE (1.2G ANT)	E2,E3,E4	94	2F	*	G11-4038-04	SHEET (KEY TOP)	J1,J2,J3
-			F15-0700-04	SHIELDING PLATE (1.2G ANT)	J,J1	94	2F	*	G11-4038-04	SHEET (KEY TOP)	K1,K3,E1
-			F15-0700-04	SHIELDING PLATE (1.2G ANT)	K1,K2,E1	95	2F	*	G11-4039-14	SHEET (KEY TOP)	E3,E5,J
-			F20-3303-04	INSULATING SHEET (SUB PANEL)		95	2F	*	G11-4039-14	SHEET (KEY TOP)	J1,J2,J3
-		*	F20-3381-04	INSULATING SHEET		95	2F	*	G11-4039-14	SHEET (KEY TOP)	K1,K3,E1
75	1A	*	F20-1185-04	INSULATING SHEET		96	2F	*	G11-4041-04	SHEET (KEY TOP)	E3,E5,J
76	3B		F29-0014-05	INSULATING BUSH (X45-360A Q2)		96	2F	*	G11-4041-04	SHEET (KEY TOP)	J1,J2,J3
66	2I		F52-0038-05	FUSE (BLADE) 4A/32V		96	2F	*	G11-4041-04	SHEET (KEY TOP)	K1,K3,E1
65	1I,2I	*	F52-0042-05	FUSE (BLADE) 15A/32V	J1,J3	97	3C	*	G11-4042-04	SHEET (FAN MOTOR)	
65	1I,2I		F52-0044-05	FUSE (BLADE) 25A/32V	E1,E2,E3	108	2F	*	G11-4045-04	SHEET (4KEY)	E3,E5,J
65	1I,2I		F52-0044-05	FUSE (BLADE) 25A/32V	E4,E5,J	108	2F	*	G11-4045-04	SHEET (4KEY)	J1,J2,J3
65	1I,2I		F52-0044-05	FUSE (BLADE) 25A/32V	J2	108	2F	*	G11-4045-04	SHEET (4KEY)	K1,K3,E1
65	1I,2I		F52-0044-05	FUSE (BLADE) 25A/32V	K1,K2,K3	-		*	G11-4053-04	SHEET (FRONT GLASS)	E3,E5,J
78	3E		G02-0505-05	KNOB SPRING	E3,E5,J	-		*	G11-4053-04	SHEET (FRONT GLASS)	K1,K3,E1
78	3E		G02-0505-05	KNOB SPRING	J1,J2,J3	-		*	G11-4059-04	SHEET (X53 CN7 FLAT CABLE)	
78	3E		G02-0505-05	KNOB SPRING	K1,K3,E1	-			G13-0855-04	CUSHION (23/5/13)	E1,E2,E3
79	1C		G02-0570-04	FLAT SPRING		-			G13-0855-04	CUSHION (23/5/13)	E4,E5
-			G02-0729-14	FLAT SPRING (1.2G,A25)		-			G13-0855-04	CUSHION (23/5/13)	K1,K2,K3
80	3E		G02-0854-03	FLAT SPRING (MAIN DAIL)	E3,E5,J	99	2E	*	G13-1775-13	CUSHION (LCD)	E3,E5,J
80	3E		G02-0854-03	FLAT SPRING (MAIN DAIL)	J1,J2,J3	99	2E	*	G13-1775-13	CUSHION (LCD)	J1,J2,J3
80	3E		G02-0854-03	FLAT SPRING (MAIN DAIL)	K1,K3,E1	99	2E	*	G13-1775-13	CUSHION (LCD)	K1,K3,E1
81	2A		G02-0875-04	EARTH SPRING (X45-360B)		100	3B		G13-1793-04	CUSHION (UNDER SP)	
82	2F		G02-0879-04	EARTH SPRING (PANEL ASSY)	E3,E5,J	101	3A		G13-1855-04	CUSHION (SP)	
82	2F		G02-0879-04	EARTH SPRING (PANEL ASSY)	J1,J2,J3	102	1C		G13-1856-04	CUSHION (DRU-3A)	
82	2F		G02-0879-04	EARTH SPRING (PANEL ASSY)	K1,K3,E1	103	1D	*	G13-1868-04	CUSHION (CABINET BOTTOM)	
83	3B	*	G02-0893-04	FLAT SPRING		104	1G	*	G13-1869-05	CONDUCTIVE CUSHION	E1,E2,E3
84	3E		G09-0405-05	KNOB SPRING (RIT,MULTI)	E3,E5,J	104	1G	*	G13-1869-05	CONDUCTIVE CUSHION	E4,E5
84	3E		G09-0405-05	KNOB SPRING (RIT,MULTI)	J1,J2,J3	104	1G	*	G13-1869-05	CONDUCTIVE CUSHION	K1,K2,K3
84	3E		G09-0405-05	KNOB SPRING (RIT,MULTI)	K1,K3,E1	105	1H	*	G13-1870-05	CONDUCTIVE CUSHION	E1,E2,E3
110	2E		G10-0789-04	FIBROUS SHEET (PANEL ASSY)	E3,E5,J	105	1H	*	G13-1870-05	CONDUCTIVE CUSHION	E4,E5
110	2E		G10-0789-04	FIBROUS SHEET (PANEL ASSY)	J1,J2,J3	105	1H	*	G13-1870-05	CONDUCTIVE CUSHION	K1,K2,K3
110	2E		G10-0789-04	FIBROUS SHEET (PANEL ASSY)	K1,K3,E1	106	1H	3H	G13-1871-05	CONDUCTIVE CUSHION	
85	3E		G10-1258-04	FIBROUS SHEET (MAIN DAIL)	E3,E5,J	107	3H	*	G13-1872-05	CONDUCTIVE CUSHION	
85	3E		G10-1258-04	FIBROUS SHEET (MAIN DAIL)	J1,J2,J3	-		*	G13-1877-05	CONDUCTIVE CUSHION (1.2G)	J3
85	3E		G10-1258-04	FIBROUS SHEET (MAIN DAIL)	K1,K3,E1	-		*	G13-1877-05	CONDUCTIVE CUSHION (1.2G)	K3,E5,J2
86	2A,3A		G10-1277-04	FIBROUS SHEET (CABINET UPPER)		-		*	G13-1878-05	CONDUCTIVE CUSHION (1.2G)	J3
87	1F	*	G10-1278-04	FIBROUS SHEET (SUB PANEL)	E3,E5,J	-		*	G13-1878-05	CONDUCTIVE CUSHION (1.2G)	K3,E5,J2
87	1F	*	G10-1278-04	FIBROUS SHEET (SUB PANEL)	J1,J2,J3	-		*	G13-1878-05	CONDUCTIVE CUSHION (1.2G)	

J : TS-2000S J1 : TS-2000V J2 : TS-2000SX J3 : TS-2000VX
 K1 : TS-2000 (K) K2 : TS-B2000 (K) K3 : TS-2000X (K)
 E1 : TS-2000 (E) E2 : TS-B2000 (E) E3 : TS-2000 (E2) E4 : TS-B2000 (E2) E5 : TS-2000X (E)

PARTS LIST

TS-2000/B2000/2000X/2000S/2000V/2000SX/2000VX (Y52-327X-XX)
FINAL UNIT (X45-360X-XX)

Ref. No.	Address	New parts	Parts No.	Description	Destination	Ref. No.	Address	New parts	Parts No.	Description	Destination	
-		*	H10-6631-12	POLYSTYRENE FOAMED FIXTURE (F)		130	3E	*	K29-5399-03	KNOB (OUTSIDE)	K1,K3,E1	
-		*	H10-6632-12	POLYSTYRENE FOAMED FIXTURE (R)		-			L79-1407-05	LINE FILTER	E1,E2,E3	
-		*	H10-6640-14	POLYSTYRENE FOAMED FIXTURE	K2,E2,E4	-			L79-1407-05	LINE FILTER	E4,E5	
-		*	H20-1448-04	PROTECTION COVER		-			L79-1407-05	LINE FILTER	K1,K2,K3	
109	2J		H52-1507-02	ITEM CARTON CASE	J	133	2I		L79-1408-05	LINE FILTER (WITH BAND)	E1,E2,E3	
109	2J		H52-1508-02	ITEM CARTON CASE	J1	133	2I		L79-1408-05	LINE FILTER (WITH BAND)	E4,E5	
109	2J		H52-1509-02	ITEM CARTON CASE	K1	A	1F		N14-0569-14	CIRCULAR NUT	E3,E5,J	
109	2J		H52-1590-02	ITEM CARTON CASE	K2	A	1F		N14-0569-14	CIRCULAR NUT	J1,J2,J3	
109	2J		H52-1711-02	ITEM CARTON CASE	J2	A	1F		N14-0569-14	CIRCULAR NUT	K1,K3,E1	
109	2J		H52-1712-02	ITEM CARTON CASE	K3	B	2C		N15-1040-48	FLAT WASHER		
109	2J		H52-1715-02	ITEM CARTON CASE	J3	C	3E		N19-0670-05	SPECIAL WASHER	E3,E5,J	
109	2J	*	H52-1773-02	ITEM CARTON CASE	E1,E3	C	3E		N19-0670-05	SPECIAL WASHER	J1,J2,J3	
109	2J	*	H52-1774-02	ITEM CARTON CASE	E2,E4	C	3E		N19-0670-05	SPECIAL WASHER	K1,K3,E1	
109	2J		H52-1893-02	ITEM CARTON CASE	E5	D	1F		N19-0673-15	SPECIAL WASHER	E3,E5,J	
111	1D		J02-0440-04	FOOT (FRONT)	E3,E5,J	D	1F	*	N19-0673-15	SPECIAL WASHER	J1,J2,J3	
111	1D		J02-0440-04	FOOT (FRONT)	J1,J2,J3	D	1F	*	N19-0673-15	SPECIAL WASHER	K1,K3,E1	
111	1D		J02-0440-04	FOOT (FRONT)	K1,K3,E1	E	2A,1D		N33-3006-43	OVAL HEAD MACHINE SCREW		
112	3A,2D	*	J02-0441-15	FOOT (SIDE)		F	1D,2D		N35-3008-41	BINDING HEAD MACHINE SCREW		
113	2D		J02-0442-04	FOOT (FRONT)		G	3C	*	N35-3020-48	BINDING HEAD MACHINE SCREW		
114	1D		J02-0475-05	FOOT (REAR)		H	2C		N35-4010-48	BINDING HEAD MACHINE SCREW		
115	3B		J21-8414-04	MOUNTING HARDWARE (1.2G)		J	2A		N67-2608-48	PAN HEAD SEMS SCREW W		
116	1E		J31-0141-04	COLLAR (MIC 8P)	K1,K3,E1	K	2A,3B	*	N68-4006-48	PAN HEAD SEMS SCREW A		
116	1E		J31-0141-04	COLLAR (MIC 8P)	E3,E5,J	L	1E2F		N87-2606-48	BRAZIER HEAD TAPTITE SCREW		
116	1E		J31-0141-04	COLLAR (MIC 8P)	J1,J2,J3	M	2B,2F		N87-2608-48	BRAZIER HEAD TAPTITE SCREW		
116	2E		J31-0141-04	COLLAR (MIC 8P)	K2,E2,E4	N	3E	*	N90-3008-48	TP HEAD MACHINE SCREW	E3,E5,J	
117	3E		J39-0638-04	SPACER (MAIN DAIL)	E3,E5,J	N	3E	*	N90-3008-48	TP HEAD MACHINE SCREW	J1,J2,J3	
117	3E		J39-0638-04	SPACER (MAIN DAIL)	J1,J2,J3	N	3E	*	N90-3008-48	TP HEAD MACHINE SCREW	K1,K3,E1	
117	3E		J39-0638-04	SPACER (MAIN DAIL)	K1,K3,E1	135	1I	*	N99-2024-15	SCREW SET	ACCESSORY	
-			J61-0307-05	BAND		-			S50-1406-05	TACT SWITCH (MICROPHONE)	E1,E2,E3	
120	2A		K01-0420-05	HANDLE		-			S50-1406-05	TACT SWITCH (MICROPHONE)	E4,E5	
121	3E		K21-1104-03	KNOB (MAIN DAIL)	E3,E5,J	-			S50-1406-05	TACT SWITCH (MICROPHONE)	K1,K2,K3	
121	3E		K21-1104-03	KNOB (MAIN DAIL)	J1,J2,J3	139	3B	*	T07-0765-05	SPEAKER		
121	3E		K21-1104-03	KNOB (MAIN DAIL)	K1,K3,E1	140	1I	*	T91-0352-35	MICROPHONE	ACCESSORY	
122	2E	*	K29-5391-12	KEY TOP (8KEY)	E3,E5,J	140	1I	*	T91-0352-35	MICROPHONE	ACCESSORY	
122	2E	*	K29-5391-12	KEY TOP (8KEY)	J1,J2,J3	140	1I	*	T91-0352-35	MICROPHONE	ACCESSORY	
122	2E	*	K29-5391-12	KEY TOP (8KEY)	K1,K3,E1	141	1J	*	T93-0123-35	CD-ROM	ACCESSORY	
123	2F	*	K29-5392-12	KEY TOP (25KEY)	E3,E5,J	142	2F		W02-1836-15	ENCODER (MAIN)	E3,E5,J	
123	2F	*	K29-5392-12	KEY TOP (25KEY)	J1,J2,J3	142	2F		W02-1836-15	ENCODER (MAIN)	J1,J2,J3	
123	2F	*	K29-5392-12	KEY TOP (25KEY)	K1,K3,E1	142	2F		W02-1836-15	ENCODER (MAIN)	K1,K3,E1	
124	2F	*	K29-5393-12	KEY TOP (18KEY)	E3,E5,J	143	1F		W02-3619-05	ENCODER (RIT/SUB)	E3,E5,J	
124	2F	*	K29-5393-12	KEY TOP (18KEY)	J1,J2,J3	143	1F		W02-3619-05	ENCODER (RIT/SUB)	J1,J2,J3	
124	2F	*	K29-5393-12	KEY TOP (18KEY)	K1,K3,E1	143	1F		W02-3619-05	ENCODER (RIT/SUB)	K1,K3,E1	
125	2F	*	K29-5394-22	KEY TOP (4KEY)	E3,E5,J	-			W09-0873-15	LITHIUM CELL (X57-605A)		
125	2F	*	K29-5394-22	KEY TOP (4KEY)	J1,J2,J3	146	2E	*	212-2017-05	HEAT-PROOF TUBE (VOX,FUNC)	E3,E5,J	
125	2F	*	K29-5394-22	KEY TOP (4KEY)	K1,K3,E1	146	2E	*	212-2017-05	HEAT-PROOF TUBE (VOX,FUNC)	J1,J2,J3	
125	2F	*	K29-5394-22	KEY TOP (4KEY)	E3,E5,J	146	2E	*	212-2017-05	HEAT-PROOF TUBE (VOX,FUNC)	K1,K3,E1	
126	3E		K29-5395-04	KNOB RING	E3,E5,J	FINAL UNIT (X45-360X-XX) 0-00 : J,J2 0-01 : J1,J3 0-11 : K1,K2,K3 2-71 : E1,E2,E3,E4,E5						
126	3E		K29-5395-04	KNOB RING (MAIN DAIL)	J1,J2,J3							
126	3E		K29-5395-04	KNOB RING (MAIN DAIL)	K1,K3,E1							
126	3E		K29-5395-04	KNOB RING (MAIN DAIL)	E3,E5,J							
127	3E		K29-5396-03	KNOB (RIT,MULTI)	J1,J2,J3							
127	3E		K29-5396-03	KNOB (RIT,MULTI)	K1,K3,E1							
128	3E	*	K29-5397-13	KNOB	E3,E5,J	C1			CK73FB1E104K	CHIP C	0.10UF	K
128	3E	*	K29-5397-13	KNOB	J1,J2,J3	C2			CK73FB1H103K	CHIP C	0.010UF	K
128	3E	*	K29-5397-13	KNOB	K1,K3,E1	C3			CK73FB1E104K	CHIP C	0.10UF	K
128	3E	*	K29-5397-13	KNOB	E3,E5,J	C4			CK73FB1H103K	CHIP C	0.010UF	K
128	3E	*	K29-5397-13	KNOB	J1,J2,J3	C5			CK73FB1H102K	CHIP C	1000PF	K
129	3E	*	K29-5398-03	KNOB (INSIDE)	E3,E5,J							
129	3E	*	K29-5398-03	KNOB (INSIDE)	J1,J2,J3							
129	3E	*	K29-5398-03	KNOB (INSIDE)	K1,K3,E1							
130	3E	*	K29-5399-03	KNOB (OUTSIDE)	E3,E5,J							
130	3E	*	K29-5399-03	KNOB (OUTSIDE)	J1,J2,J3							

PARTS LIST

FINAL UNIT (X45-360X-XX)

Ref. No.	Address	New parts	Parts No.	Description	Desti-nation	Ref. No.	Address	New parts	Parts No.	Description	Desti-nation
C6			CK73FB1E104K	CHIP C 0.10UF K		C102			C93-0560-05	CHIP C 10PF D	
C7			CK73FB1C105K	CHIP C 1.0UF K		C104			C93-0571-05	CHIP C 82PF J	J1,J3
C8,9			CK73FB1E104K	CHIP C 0.10UF K		C104			C93-0572-05	CHIP C 100PF J	E1,E2,E3
C10			CK73FB1C105K	CHIP C 1.0UF K		C104			C93-0572-05	CHIP C 100PF J	E4,E5,J
C11			CK73FB1H102K	CHIP C 1000PF K		C104			C93-0572-05	CHIP C 100PF J	J2
C12		*	CD04A21H100M	ELECTRO 10UF 50WV		C104			C93-0572-05	CHIP C 100PF J	K1,K2,K3
C13			CK73FB1E104K	CHIP C 0.10UF K		C106			C93-0571-05	CHIP C 82PF J	J1,J3
C14			CK73FB1H102K	CHIP C 1000PF K		C106			C93-0572-05	CHIP C 100PF J	E1,E2,E3
C15			CK73FB1E104K	CHIP C 0.10UF K		C106			C93-0572-05	CHIP C 100PF J	E4,E5,J
C16			CC73FCH1H100D	CHIP C 10PF D		C106			C93-0572-05	CHIP C 100PF J	J2
C17			CK73FB1E104K	CHIP C 0.10UF K		C106			C93-0572-05	CHIP C 100PF J	K1,K2,K3
C20			CC73FCH1H331J	CHIP C 330PF J		C107			CM73F2H271J	CHIP C 270PF J	
C21			CK73FB1E104K	CHIP C 0.10UF K		C108			CM73F2H221J	CHIP C 220PF J	
C22			CK73FB1H102K	CHIP C 1000PF K		C110			CM73F2H271J	CHIP C 270PF J	
C24			CK73FB1E104K	CHIP C 0.10UF K		C111			CM73F2H221J	CHIP C 220PF J	
C25			CK73FB1C105K	CHIP C 1.0UF K		C117			CM73F2H181J	CHIP C 180PF J	E1,E2,E3
C26			CC73FCH1H390J	CHIP C 39PF J		C117			CM73F2H181J	CHIP C 180PF J	E4,E5,J
C27			CC73FCH1H470J	CHIP C 47PF J		C117			CM73F2H181J	CHIP C 180PF J	J2
C29,30			CK73EB1H104K	CHIP C 0.10UF K		C117			CM73F2H181J	CHIP C 180PF J	K1,K2,K3
C31			C93-0569-05	CHIP C 56PF J		C118			CM73F2H151J	CHIP C 150PF J	E1,E2,E3
C32			CK73FB1H102K	CHIP C 1000PF K		C118			CM73F2H151J	CHIP C 150PF J	E4,E5,J
C33		*	CD04A21H100M	ELECTRO 10UF 50WV		C118			CM73F2H151J	CHIP C 150PF J	J2
C34			CD04AY1E470M	ELECTRO 47UF 25WV		C118			CM73F2H151J	CHIP C 150PF J	K1,K2,K3
C35			CK73FB1E104K	CHIP C 0.10UF K		C125			CK73EF1V225Z	CHIP C 2.2UF Z	
C36			CK73FB1C105K	CHIP C 1.0UF K		C127			CK73FB1H102K	CHIP C 1000PF K	
C37			CK73FB1H102K	CHIP C 1000PF K		C130			CM73F2H151J	CHIP C 150PF J	E1,E2,E3
C38			CK73FB1E104K	CHIP C 0.10UF K		C130			CM73F2H151J	CHIP C 150PF J	E4,E5,J
C39			CK73FB1H102K	CHIP C 1000PF K		C130			CM73F2H151J	CHIP C 150PF J	J2
C40			CK73FB1C105K	CHIP C 1.0UF K		C130			CM73F2H151J	CHIP C 150PF J	K1,K2,K3
C41,42			CK73FB1E104K	CHIP C 0.10UF K		C131			CM73F2H181J	CHIP C 180PF J	E1,E2,E3
C43			CK73FB1H103K	CHIP C 0.010UF K		C131			CM73F2H181J	CHIP C 180PF J	E4,E5,J
C44			CK73FB1C105K	CHIP C 1.0UF K		C131			CM73F2H181J	CHIP C 180PF J	J2
C45			CK73FB1H103K	CHIP C 0.010UF K		C131			CM73F2H181J	CHIP C 180PF J	K1,K2,K3
C46			C93-0568-05	CHIP C 47PF J		C132			CC73FSL1H471J	CHIP C 470PF J	
C47			CM73F2H271J	CHIP C 270PF J		C133			CK73FB1H103K	CHIP C 0.010UF K	
C48			CM73F2H391J	CHIP C 390PF J		C135			CK73FB1E104K	CHIP C 0.10UF K	
C49-56			C93-0608-05	CHIP C 2700PF K	E1,E2,E3	C138			CK73FB1H102K	CHIP C 1000PF K	
C49-56			C93-0608-05	CHIP C 2700PF K	E4,E5,J	C139,140			CC73FSL1H331J	CHIP C 330PF J	
C49-56			C93-0608-05	CHIP C 2700PF K	J2	C141			CK73FB1H102K	CHIP C 1000PF K	
C49-56			C93-0608-05	CHIP C 2700PF K	K1,K2,K3	C142			CK73FB1E104K	CHIP C 0.10UF K	
C50,51			C93-0599-05	CHIP C 470PF K	J1,J3	C143			CK73FB1H471K	CHIP C 470PF K	
C54,55			C93-0599-05	CHIP C 470PF K	J1,J3	C144		*	CD04A21H100M	ELECTRO 10UF 50WV	
C57,58			C93-0572-05	CHIP C 100PF J		C145			CK73FB1H471K	CHIP C 470PF K	
C59,60			C93-0568-05	CHIP C 47PF J		C146			CK73FB1E104K	CHIP C 0.10UF K	
C61			CM73F2H331J	CHIP C 330PF J		C147			CK73FB1H102K	CHIP C 1000PF K	
C63			C93-0555-05	CHIP C 5.0PF C		C148			CC73FSL1H471J	CHIP C 470PF J	
C67			C93-0555-05	CHIP C 5.0PF C		C149			CK73FB1H103K	CHIP C 0.010UF K	
C68			CK73FB1E104K	CHIP C 0.10UF K		C150		*	CM73F2H680F	CHIP C 68PF F	E1,E2,E3
C69			CK73FB1H102K	CHIP C 1000PF K		C150		*	CM73F2H680F	CHIP C 68PF F	E4,E5,J
C70		*	CD04A21H100M	ELECTRO 10UF 50WV		C150		*	CM73F2H680F	CHIP C 68PF F	J2
C71			CK73FB1H103K	CHIP C 0.010UF K		C150		*	CM73F2H680F	CHIP C 68PF F	K1,K2,K3
C72			CK73FB1E104K	CHIP C 0.10UF K		C150			CM73F2H680J	CHIP C 68PF J	J1,J3
C73			CK73FB1H102K	CHIP C 1000PF K		C151			C93-0562-05	CHIP C 15PF J	J1,J3
C74			CK73FB1E104K	CHIP C 0.10UF K		C152			C93-0554-05	CHIP C 4.0PF C	E1,E2,E3
C79		*	CD04BC1E221M	ELECTRO 220UF 25WV		C152			C93-0554-05	CHIP C 4.0PF C	E4,E5,J
C101			C93-0567-05	CHIP C 39PF J	E1,E2,E3	C152			C93-0554-05	CHIP C 4.0PF C	J2
C101			C93-0567-05	CHIP C 39PF J	E4,E5,J	C152			C93-0554-05	CHIP C 4.0PF C	K1,K2,K3
C101			C93-0567-05	CHIP C 39PF J	J2	C153		*	CM73F2H680F	CHIP C 68PF F	E1,E2,E3
C101			C93-0567-05	CHIP C 39PF J	K1,K2,K3	C153		*	CM73F2H680F	CHIP C 68PF F	E4,E5,J
C101			C93-0569-05	CHIP C 56PF J	J1,J3	C153		*	CM73F2H680F	CHIP C 68PF F	J2

J : TS-2000S J1 : TS-2000V J2 : TS-2000SX J3 : TS-2000VX

K1 : TS-2000 (K) K2 : TS-B2000 (K) K3 : TS-2000X (K)

E1 : TS-2000 (E) E2 : TS-B2000 (E) E3 : TS-2000 (E2) E4 : TS-B2000 (E2) E5 : TS-2000X (E)

PARTS LIST

FINAL UNIT (X45-360X-XX)

Ref. No.	Address	New parts	Parts No.	Description	Destination	Ref. No.	Address	New parts	Parts No.	Description	Destination
C153		*	CM73F2H680F	CHIP C 68PF F	K1,K2,K3	C807			CK73FB1E104K	CHIP C 0.10UF K	
C153			CM73F2H680J	CHIP C 68PF J	J1,J3	C808,809			CK73FB1H103K	CHIP C 0.010UF K	
C154			C93-0562-05	CHIP C 15PF J	J1,J3	C810-815			C91-3115-05	HV CAP 10PF 2KV	
C155			C93-0554-05	CHIP C 4.0PF C	E1,E2,E3	C816-821			CK73FB1H103K	CHIP C 0.010UF K	
C155			C93-0554-05	CHIP C 4.0PF C	E4,E5,J	C822-827			C91-3115-05	HV CAP 10PF 2KV	
C155			C93-0554-05	CHIP C 4.0PF C	J2	C828-833			CK73FB1H103K	CHIP C 0.010UF K	
C155			C93-0554-05	CHIP C 4.0PF C	K1,K2,K3	C834,835			C91-3115-05	HV CAP 10PF 2KV	
C157			CM73F2H200J	CHIP C 20PF J		C836			C91-3126-05	HV CAP 10PF 3KV	
C158,159			C93-0603-05	CHIP C 1000PF K		C837-842			CK73FB1H103K	CHIP C 0.010UF K	
C160			C93-0560-05	CHIP C 10PF D		C843			C91-3126-05	HV CAP 10PF 3KV	
C161,162			CC73FCH1H100D	CHIP C 10PF D		C844			C91-3127-05	HV CAP 18PF 3KV	
C201,202			CK73FB1H102K	CHIP C 1000PF K		C845-850			CK73FB1H103K	CHIP C 0.010UF K	
C203,204			CK73FB1H103K	CHIP C 0.010UF K		C851,852			C91-3127-05	HV CAP 18PF 3KV	
C205			C91-2691-05	CERAMIC 470PF 250WV		C853-858			CK73FB1H103K	CHIP C 0.010UF K	
C206			CK73FB1H103K	CHIP C 0.010UF K		C859			C91-3127-05	HV CAP 18PF 3KV	
C207		*	CD04AZ1E471M	ELECTRO 470UF 25WV		C860-865			CK73FB1H103K	CHIP C 0.010UF K	
C208			CK73FB1H103K	CHIP C 0.010UF K		C866-869			C91-3123-05	HV CAP 150PF 3KV	
C209			CK73FB1E104K	CHIP C 0.10UF K		C870-875			CK73FB1H103K	CHIP C 0.010UF K	
C210			CK73FB1H103K	CHIP C 0.010UF K		C876,877			C91-3123-05	HV CAP 150PF 3KV	
C211			CK73FB1E104K	CHIP C 0.10UF K		C878-883			CK73FB1H103K	CHIP C 0.010UF K	
C212			CK73FB1H103K	CHIP C 0.010UF K		C884-887			C91-3123-05	HV CAP 150PF 3KV	
C213		*	CD04AZ1E471M	ELECTRO 470UF 25WV		C888			CK73FB1E104K	CHIP C 0.10UF K	
C214			CK73FB1H103K	CHIP C 0.010UF K		C890,891			C91-3127-05	HV CAP 18PF 3KV	
C215			CK73FB1E104K	CHIP C 0.10UF K		C901			CC73FCH1H470J	CHIP C 47PF J	
C216			CK73FB1H102K	CHIP C 1000PF K		C903			CD04AY1E470M	ELECTRO 47UF 25WV	
C217-221			CK73FB1E104K	CHIP C 0.10UF K		C904,905			CK73FB1H471K	CHIP C 470PF K	
C222,223		*	CD04AZ1H100M	ELECTRO 10UF 50WV		C906,907			CK73FB1H103K	CHIP C 0.010UF K	
C224		*	CD04AZ1V102M	ELECTRO 1000UF 35WV		C908,909			CK73FB1H471K	CHIP C 470PF K	
C225,226			CK73FB1E104K	CHIP C 0.10UF K		C911,912			CK73FB1H471K	CHIP C 470PF K	
C227			C90-2021-05	ELECTRO 10UF 25WV		C914			CK73FB1C105K	CHIP C 1.0UF K	
C228,229			CK73FB1E104K	CHIP C 0.10UF K		C915			CC73FCH1H101J	CHIP C 100PF J	
C230		*	CD04AZ1H100M	ELECTRO 10UF 50WV		C916			CK73FB1H103K	CHIP C 0.010UF K	
C231			CK73FB1E104K	CHIP C 0.10UF K		C919,920			CK73FB1H471K	CHIP C 470PF K	
C232-234			CK73FB1H103K	CHIP C 0.010UF K		C921			CK73FB1H103K	CHIP C 0.010UF K	
C235,236			CK73FB1H102K	CHIP C 1000PF K		C922			CK73FB1C105K	CHIP C 1.0UF K	
C237			CK73FB1H103K	CHIP C 0.010UF K		C924			CK73FB1H103K	CHIP C 0.010UF K	
C238			CK73FB1H102K	CHIP C 1000PF K		C926			CK73FB1H471K	CHIP C 470PF K	
C239			CD04AY1E470M	ELECTRO 47UF 25WV		C928	*		CD04AZ1H100M	ELECTRO 10UF 50WV	
C240-244			CK73FB1H102K	CHIP C 1000PF K		C931			CC73FCH1H180J	CHIP C 18PF J	
C250		*	CD04AZ1E471M	ELECTRO 470UF 25WV		C932			CC73FCH1H100D	CHIP C 10PF D	
C251			CK73FB1E104K	CHIP C 0.10UF K		C933			CD04AY1E470M	ELECTRO 47UF 25WV	
C252			CC73FCH1H470J	CHIP C 47PF J		C934,935			CK73FB1H471K	CHIP C 470PF K	
C253,254		*	CD04AZ1V101M	ELECTRO 100UF 35WV		C936,937			CM73F2H330J	CHIP C 33PF J	E1,E2,E3
C255			CK73FB1H103K	CHIP C 0.010UF K		C936,937			CM73F2H330J	CHIP C 33PF J	E4,E5,J
C256		*	CD04AZ1HR22M	ELECTRO 0.22UF 50WV		C936,937			CM73F2H330J	CHIP C 33PF J	J2
C259,260			CM73F2H331J	CHIP C 330PF J		C936,937			CM73F2H330J	CHIP C 33PF J	K1,K2,K3
C262			CK73EF1V225Z	CHIP C 2.2UF Z		C938			CK73FB1H103K	CHIP C 0.010UF K	
C263			CK73FB1E104K	CHIP C 0.10UF K		C940			CK73FB1H471K	CHIP C 470PF K	
C264			CK73FB1H102K	CHIP C 1000PF K		C941,942			CK73FB1H103K	CHIP C 0.010UF K	
C265			CK73FB1H103K	CHIP C 0.010UF K		C943			C93-0564-05	CHIP C 22PF J	
C270			C93-0561-05	CHIP C 12PF J		C944	*		CD04AZ1H100M	ELECTRO 10UF 50WV	
C271			C93-0565-05	CHIP C 27PF J		C945,946			CK73FB1H471K	CHIP C 470PF K	
C272,273			CK73FB1H102K	CHIP C 1000PF K	E1,E2,E3	C947			C93-0564-05	CHIP C 22PF J	
C272,273			CK73FB1H102K	CHIP C 1000PF K	E4,E5	C948			CK73FB1H103K	CHIP C 0.010UF K	
C274			CK73FB1H103K	CHIP C 0.010UF K		C949,950			CM73F2H330J	CHIP C 33PF J	
C501,502			CK45FB1H103KN	CERAMIC 0.010UF K		C952,953			CK73FB1H471K	CHIP C 470PF K	
C511,512			CK45FB1H103KN	CERAMIC 0.010UF K		C955	*		CD04AZ1H100M	ELECTRO 10UF 50WV	
C801-803			CK73FB1E104K	CHIP C 0.10UF K		C956			CK73FB1H103K	CHIP C 0.010UF K	
C804			CK73FB1H102K	CHIP C 1000PF K		C958			CK73FB1E104K	CHIP C 0.10UF K	
C805,806			C91-3115-05	HV CAP 10PF 2KV		C959	*		CD04AS1E470M	ELECTRO 47UF 25WV	

PARTS LIST

FINAL UNIT (X45-360X-XX)

Ref. No.	Address	New parts	Parts No.	Description	Desti-nation	Ref. No.	Address	New parts	Parts No.	Description	Desti-nation
C960,961			CM73F2H390J	CHIP C 39PF J	E1,E2,E3	CN905			E04-0190-05	PIN SOCKET	
C960,961			CM73F2H390J	CHIP C 39PF J	E4,E5,J	CN906			E23-0486-05	TERMINAL	
C960,961			CM73F2H390J	CHIP C 39PF J	J2	CN907-909		*	E23-1310-05	TEST TERMINAL	
C960,961			CM73F2H390J	CHIP C 39PF J	K1,K2,K3	W1		*	E37-0975-15	LEAD WIRE WITH TERMINAL	J,J1,J2
C962			CK73FB1H471K	CHIP C 470PF K		W1		*	E37-0975-15	LEAD WIRE WITH TERMINAL	J3
C963			CK73FB1H103K	CHIP C 0.010UF K		W1		*	E37-0975-15	LEAD WIRE WITH TERMINAL	K1,K2,K3
C964			CM73F2H040D	CHIP C 4.0PF D	E1,E2,E3	W1		*	E37-0976-15	LEAD WIRE WITH TERMINAL	E1,E2,E3
C964			CM73F2H040D	CHIP C 4.0PF D	E4,E5,J	W1		*	E37-0976-15	LEAD WIRE WITH TERMINAL	E4,E5
C964			CM73F2H040D	CHIP C 4.0PF D	J2						
C964			CM73F2H040D	CHIP C 4.0PF D	K1,K2,K3	F1			F06-5023-05	FUSE (5A/125V)	
C965		*	CD04A21H100M	ELECTRO 10UF 50WV		F2			F52-0038-05	FUSE (BLADE) (4A/32V)	
C966			CK73FB1H103K	CHIP C 0.010UF K		CN6,7			J13-0410-05	FUSE HOLDER	
C967			CK73FB1H471K	CHIP C 470PF K		-			L92-0105-05	TROIDAL CORE	
C968			C93-0599-05	CHIP C 470PF K		-			L92-0412-05	TROIDAL CORE	E1,E2,E3
C969			CK73FB1H471K	CHIP C 470PF K		-			L92-0412-05	TROIDAL CORE	E4,E5
C970			CK73FB1H103K	CHIP C 0.010UF K		L1			L41-4705-33	SMALL FIXED INDUCTOR (47UH)	
C971			CK73FB1H471K	CHIP C 470PF K		L2			L41-1095-33	SMALL FIXED INDUCTOR (1.0UH)	
C973,974			CK73FB1H471K	CHIP C 470PF K							
C976			CK73FB1H471K	CHIP C 470PF K		L3			L33-0699-05	CHOKE COIL	
C977			C93-0599-05	CHIP C 470PF K		L4			L41-4705-33	SMALL FIXED INDUCTOR (47UH)	
C978			C93-0559-05	CHIP C 9.0PF D		L5			L39-1255-15	TOROIDAL COIL	
C980			C93-0555-05	CHIP C 5.0PF C		L6			L33-0699-05	CHOKE COIL	
C981			CC73FCH1H471J	CHIP C 470PF J		L7			L39-1452-05	TOROIDAL COIL	
C982			CM73F2H120J	CHIP C 12PF J		L8			L92-0131-05	CHIP FERRITE	
C983			C93-0553-05	CHIP C 3.0PF C		L9,10			L33-0699-05	CHOKE COIL	
C985			C93-0566-05	CHIP C 33PF J		L11			L39-1434-05	TOROIDAL COIL	
C987			C93-0562-05	CHIP C 15PF J		L13			L39-1434-05	TOROIDAL COIL	
C989-991			CC73FCH1H101J	CHIP C 100PF J		L14-16			L33-0699-05	CHOKE COIL	
C992			CM73F2H240J	CHIP C 24PF J	E1,E2,E3	L17			L39-1451-05	TOROIDAL COIL	
C992			CM73F2H240J	CHIP C 24PF J	E4,E5,J	L18		*	L39-1437-15	TOROIDAL COIL	
C992			CM73F2H240J	CHIP C 24PF J	J2	L21			L34-1231-15	AIR-CORE COIL	
C992			CM73F2H270J	CHIP C 27PF J	K1,K2,K3	L23			L41-4795-33	SMALL FIXED INDUCTOR (4.7UH)	
C993			C93-0558-05	CHIP C 8.0PF D	J1,J3	L24			L33-0617-15	CHOKE COIL	
C994			CM73F2H060D	CHIP C 6.0PF D		L25			L33-0651-05	CHOKE COIL	
C995			C93-0566-05	CHIP C 33PF J		L26			L41-4795-33	SMALL FIXED INDUCTOR (4.7UH)	
C996,997			CC73FCH1H471J	CHIP C 470PF J		L27			L39-1450-05	TOROIDAL COIL	
TC101,102			C05-0309-05	CERAMIC TRIMMER CAPACITOR (40P)		L29			L39-1450-05	TOROIDAL COIL	
TC901			C05-0030-15	CERAMIC TRIMMER CAPACITOR (20P)		L30-33			L92-0149-05	CHIP FERRITE	
CN1,2			E04-0154-05	PIN SOCKET		L101,102			L34-0895-05	AIR-CORE COIL	
CN3		*	E23-1310-05	TEST TERMINAL		L103,104			L34-1058-05	AIR-CORE COIL	
CN4			E04-0154-05	PIN SOCKET		L105,106			L34-1177-05	AIR-CORE COIL	
CN5		*	E40-6528-05	PIN ASSY		L107,108			L34-0908-05	AIR-CORE COIL	
CN8		*	E40-6525-05	PIN ASSY		L109			L34-1359-05	AIR-CORE COIL	
CN9			E40-6078-05	FLAT CABLE CONNECTOR		L111,112			L41-1095-33	SMALL FIXED INDUCTOR (1.0UH)	
CN10			E40-5764-05	FLAT CABLE CONNECTOR		L114			L92-0149-05	CHIP FERRITE	
CN11,12		*	E23-1310-05	TEST TERMINAL		L115			L34-4652-05	AIR-CORE COIL	
CN14		*	E23-1310-05	TEST TERMINAL		L116			L34-4656-05	AIR-CORE COIL	
CN15		*	E41-1692-05	PIN ASSY		L117			L34-1185-05	AIR-CORE COIL	
CN16		*	E41-1690-05	PIN ASSY		L118			L34-4652-05	AIR-CORE COIL	
CN17		*	E23-1310-05	TEST TERMINAL		L119			L34-4653-05	AIR-CORE COIL	
CN22			E41-1682-05	PIN ASSY		L120			L34-4402-05	AIR-CORE COIL	
CN27		*	E40-6526-05	PIN ASSY		L121,122			L34-0452-05	AIR-CORE COIL	
CN102,103		*	E23-1310-05	TEST TERMINAL		L124,125			L92-0149-05	CHIP FERRITE	
CN203,204			E23-1116-05	RELAY TERMINAL		L126			L34-4658-05	AIR-CORE COIL	
CN801,802			E04-0154-05	PIN SOCKET		L127			L92-0149-05	CHIP FERRITE	
CN901			E04-0190-05	PIN SOCKET		L201,202			L41-4705-33	SMALL FIXED INDUCTOR (47UH)	
CN902			E40-5765-05	FLAT CABLE CONNECTOR		L205			L40-1001-12	SMALL FIXED INDUCTOR	
CN903,904			E23-1116-05	RELAY TERMINAL		L206,207			L41-1005-33	SMALL FIXED INDUCTOR (10UH)	

J : TS-2000S J1 : TS-2000V J2 : TS-2000SX J3 : TS-2000VX

K1 : TS-2000 (K) K2 : TS-B2000 (K) K3 : TS-2000X (K)

E1 : TS-2000 (E) E2 : TS-B2000 (E) E3 : TS-2000 (E2) E4 : TS-B2000 (E2) E5 : TS-2000X (E)

PARTS LIST

FINAL UNIT (X45-360X-XX)

Ref. No.	Address	New parts	Parts No.	Description	Destination	Ref. No.	Address	New parts	Parts No.	Description	Destination
L210			L41-1095-33	SMALL FIXED INDUCTOR (1.0UH)		R7			RK73FB2B152J	CHIP R 1.5K J 1/8W	
L211			L92-0131-05	CHIP FERRITE		R8			RK73FB2B471J	CHIP R 470 J 1/8W	
L501,502			L39-0421-04	COIL		R9			RK73FB2B100J	CHIP R 10 J 1/8W	
L801			L40-1001-12	SMALL FIXED INDUCTOR		R10			RK73FB2B000J	CHIP R 0 OHM	
L802,803			L39-1441-05	TOROIDAL COIL		R11			RK73FB2B221J	CHIP R 220 J 1/8W	
L804			L39-1440-05	TOROIDAL COIL		R12			RK73FB2B391J	CHIP R 390 J 1/8W	
L805-807			L41-4705-33	SMALL FIXED INDUCTOR (47UH)		R13			RK73FB2B471J	CHIP R 470 J 1/8W	
L808			L34-4633-05	AIR-CORE COIL		R14			RK73RB2H2R2J	CHIP R 2.2 J 1/2W	
L809-811			L41-4705-33	SMALL FIXED INDUCTOR (47UH)		R15		*	RK73EB2E221J	CHIP R 220 J 1/4W	
L812			L34-4630-05	AIR-CORE COIL		R16-19			RK73FB2B1R0J	CHIP R 1.0 J 1/8W	
L813-815			L41-4705-33	SMALL FIXED INDUCTOR (47UH)		R20,21			RK73FB2B101J	CHIP R 100 J 1/8W	
L816			L34-4490-05	AIR-CORE COIL		R24			RK73RB2H101J	CHIP R 100 J 1/2W	
L817-819			L41-4705-33	SMALL FIXED INDUCTOR (47UH)		R25			RK73FB2B820J	CHIP R 82 J 1/8W	
L820			L34-4490-05	AIR-CORE COIL		R26			RK73FB2B270J	CHIP R 27 J 1/8W	
L821-823			L41-4705-33	SMALL FIXED INDUCTOR (47UH)		R27		*	RK73RB2H561J	CHIP R 560 J 1/2W	
L824		*	L34-4628-05	AIR-CORE COIL		R30			R92-1318-05	CHIP R 100 J 1W	
L825-827			L41-4705-33	SMALL FIXED INDUCTOR (47UH)		R31,32			R92-2673-05	CHIP R 1.0 J 1W	E1,E2,E3
L828			L34-4490-05	AIR-CORE COIL		R31,32			R92-2673-05	CHIP R 1.0 J 1W	E4,E5,J
L829-831			L41-4705-33	SMALL FIXED INDUCTOR (47UH)		R31,32			R92-2673-05	CHIP R 1.0 J 1W	J2
L832			L34-4490-05	AIR-CORE COIL		R31,32			R92-2673-05	CHIP R 1.0 J 1W	K1,K2,K3
L833-835			L41-4705-33	SMALL FIXED INDUCTOR (47UH)		R31,32			R92-3510-05	CHIP R 2.2 J 1W	J1,J3
L852,853			L39-1441-05	TOROIDAL COIL		R33,34			R92-3507-05	RESISTOR 8.2	J1,J3
L854			L39-1440-05	TOROIDAL COIL		R33,34			R92-3511-05	CHIP R 8.2 J 1/2W	E1,E2,E3
L855			L34-1177-05	AIR-CORE COIL		R33,34			R92-3511-05	CHIP R 8.2 J 1/2W	E4,E5,J
L901			L41-1085-33	SMALL FIXED INDUCTOR (0.1UH)		R33,34			R92-3511-05	CHIP R 8.2 J 1/2W	J2
L902			L92-0149-05	CHIP FERRITE		R33,34			R92-3511-05	CHIP R 8.2 J 1/2W	K1,K2,K3
L903			L41-1095-33	SMALL FIXED INDUCTOR (1.0UH)		R35-40			RK73EB2E1R0J	CHIP R 1.0 J 1/4W	
L904			L92-0149-05	CHIP FERRITE		R41,42			R92-1240-05	CHIP R 10 J 1/4W	
L905			L34-0895-05	AIR-CORE COIL		R43			RK73FB2B331J	CHIP R 330 J 1/8W	
L906			L34-0742-05	AIR-CORE COIL		R44			RS14DB3A4R7J	FL-PROOF RS 4.7 J 1W	
L907			L92-0149-05	CHIP FERRITE		R45,46			RS14DB3D390J	FL-PROOF RS 39 J 2W	
L909			L34-0742-05	AIR-CORE COIL		R101			R92-1318-05	CHIP R 100 J 1W	
L910			L34-1185-05	AIR-CORE COIL		R102			RS14DB3A100J	FL-PROOF RS 10 J 1W	
L911			L41-1085-33	SMALL FIXED INDUCTOR (0.1UH)		R103			RS14DB3F101J	FL-PROOF RS 100 J 3W	
L912			L34-0742-05	AIR-CORE COIL		R106			RK73RB2H101J	CHIP R 100 J 1/2W	
L913			L92-0149-05	CHIP FERRITE		R107		*	RK73RB2H270J	CHIP R 27 J 1/2W	
L915			L34-1232-15	AIR-CORE COIL		R108			RK73FB2B100J	CHIP R 10 J 1/8W	
L916			L34-1231-15	AIR-CORE COIL		R109			RK73FB2B331J	CHIP R 330 J 1/8W	
L917			L34-1239-05	AIR-CORE COIL		R110			RK73FB2B470J	CHIP R 47 J 1/8W	J1,J3
L918,919			L34-1185-05	AIR-CORE COIL		R110			RK73FB2B561J	CHIP R 560 J 1/8W	E1,E2,E3
L921,922			L34-1185-05	AIR-CORE COIL		R110			RK73FB2B561J	CHIP R 560 J 1/8W	E4,E5,J
L923			L34-4617-15	AIR-CORE COIL		R110			RK73FB2B561J	CHIP R 560 J 1/8W	J2
L924			L34-1239-05	AIR-CORE COIL		R110			RK73FB2B561J	CHIP R 560 J 1/8W	K1,K2,K3
L926			L41-2275-33	SMALL FIXED INDUCTOR (22NH)		R111			RK73RB2H120J	CHIP R 12 J 1/2W	
L927-931			L41-1085-33	SMALL FIXED INDUCTOR (100NH)		R112,113			RK73RB2H220J	CHIP R 22 J 1/2W	J1,J3
L932			L34-4617-15	AIR-CORE COIL		R201			RK73FB2B472J	CHIP R 4.7K J 1/8W	
CN803,804			R92-1061-05	JUMPER REST 0 OHM		R202		*	RK73PB2H2R2J	CHIP R 2.2 J 1/2W	E1,E2,E3
R1-3			RK73FB2B101J	CHIP R 100 J 1/8W	J1,J3	R202		*	RK73PB2H2R2J	CHIP R 2.2 J 1/2W	E4,E5
R1,2			RK73FB2B101J	CHIP R 100 J 1/8W	E1,E2,E3	R202			R92-2536-05	CHIP R 2.2 J 1/4W	J,J1,J2
R1,2			RK73FB2B101J	CHIP R 100 J 1/8W	E4,E5,J	R202			R92-2536-05	CHIP R 2.2 J 1/4W	J3
R1,2			RK73FB2B101J	CHIP R 100 J 1/8W	J2	R202			R92-2536-05	CHIP R 2.2 J 1/4W	K1,K2,K3
R1,2			RK73FB2B101J	CHIP R 100 J 1/8W	K1,K2,K3	R203			RK73FB2B472J	CHIP R 4.7K J 1/8W	
R3			RK73FB2B150J	CHIP R 15 J 1/8W	E1,E2,E3	R204			RK73RB2H180J	CHIP R 18 J 1/2W	
R3			RK73FB2B150J	CHIP R 15 J 1/8W	E4,E5,J	R205			RK73FB2B102J	CHIP R 1.0K J 1/8W	
R3			RK73FB2B150J	CHIP R 15 J 1/8W	J2	R206			RK73FB2B100J	CHIP R 10 J 1/8W	J,J1,J2
R3			RK73FB2B150J	CHIP R 15 J 1/8W	K1,K2,K3	R206			RK73FB2B100J	CHIP R 10 J 1/8W	J3
R4			RK73FB2B681J	CHIP R 680 J 1/8W		R206			RK73FB2B100J	CHIP R 10 J 1/8W	K1,K2,K3
R5			RK73FB2B332J	CHIP R 3.3K J 1/8W		R207			RK73FB2B333J	CHIP R 33K J 1/8W	
R6			RK73FB2B681J	CHIP R 680 J 1/8W		R208		*	RK73FB2B911J	CHIP R 910 J 1/8W	
						R209-212			RK73FB2B101J	CHIP R 100 J 1/8W	

PARTS LIST

FINAL UNIT (X45-360X-XX)

Ref. No.	Address	New parts	Parts No.	Description	Desti-nation	Ref. No.	Address	New parts	Parts No.	Description	Desti-nation
R213			RK73RB2H2R2J	CHIP R 2.2 J 1/2W		K821			S76-0415-05	RELAY	
R214			RK73EB2E000J	CHIP R 0 OHM		K822,823			S76-0419-25	RELAY	
R216,217			RK73FB2B000J	CHIP R 0 OHM		K824			S76-0415-05	RELAY	
R218			RK73FB2B101J	CHIP R 100 J 1/8W		D1			DAN235E	DIODE	
R219			RK73FB2B681J	CHIP R 680 J 1/8W		D2	*		MA2C029WBF	VARIISTOR	
R220			RK73FB2B100J	CHIP R 10 J 1/8W		D3			1SS355	DIODE	
R221			RK73FB2B4R7J	CHIP R 4.7 J 1/8W		D5			DAN202K	DIODE	
R222			RK73EB2E000J	CHIP R 0 OHM		D6			1SS355	DIODE	
R223			RK73FB2B181J	CHIP R 180 J 1/8W		D7,8			MA2B027(B)	VARIISTOR	
R224			RK73FB2B680J	CHIP R 68 J 1/8W		D101,102			MA3J742	DIODE	
R225			RK73FB2B332J	CHIP R 3.3K J 1/8W		D103,104			MA2B027(B)	VARIISTOR	
R226			RK73FB2B103J	CHIP R 10K J 1/8W		D201			ZSH5MA27	SURGE ABSORBER	
R227			RK73FB2B122J	CHIP R 1.2K J 1/8W		D202			1SS355	DIODE	
R228			RK73FB2B270J	CHIP R 27 J 1/8W		D203	*		02CZ16(Y)F	ZENER DIODE	
R501,502			RS14DB3F820J	FL-PROOF RS 82 J 3W		D204			1SS355	DIODE	
R901			RK73FB2B563J	CHIP R 56K J 1/8W		D206-209			DAP202U	DIODE	
R902			RK73FB2B000J	CHIP R 0 OHM		D210			1SS355	DIODE	
R903			RK73FB2B470J	CHIP R 47 J 1/8W		D211	*		02CZ12(Z)F	ZENER DIODE	
R904	*		RK73FB2B274J	CHIP R 270K J 1/8W		D801-824			1SS355	DIODE	
R906			RK73FB2B000J	CHIP R 0 OHM		D901-903			MA2B027(B)	VARIISTOR	
R907			RK73FB2B332J	CHIP R 3.3K J 1/8W		D904,905	*		HSM88ASR-E	DIODE	
R908			RK73FB2B000J	CHIP R 0 OHM		D906			MA4PH633	DIODE	
R909			RK73FB2B470J	CHIP R 47 J 1/8W		D908			L709CER	DIODE	
R910			RK73FB2B183J	CHIP R 18K J 1/8W		D909	*		HVU131-E	DIODE	
R911			RK73FB2B221J	CHIP R 220 J 1/8W		IC201	*		TA7808FQ	ANALOGUE IC	
R912			R92-1221-05	CHIP R 82 J 1/4W		IC202	*		TA7808SQ	BI-POLAR IC	
R913			RK73FB2B391J	CHIP R 390 J 1/8W		IC203	*		BA10T	MOS-IC	
R914			RK73RB2H151J	CHIP R 150 J 1/2W		IC204			TA7805FQ	IC (AVR)	
R915			RK73RB2H820J	CHIP R 82 J 1/2W		IC205			BU2099FV	IC (EXTENDED I/O)	
R916,917			RK73FB2B681J	CHIP R 680 J 1/8W		IC801-803	*		UPD6345GS-A	IC (EXTENDED I/O)	
R918			RK73RB2H820J	CHIP R 82 J 1/2W		Q1			2SK2596	FET	
R919-922			RK73FB2B183J	CHIP R 18K J 1/8W		Q2	*		2SC1971-101	TRANSISTOR	
R923,924			RK73FB2B220J	CHIP R 22 J 1/8W		Q3,4	*		2SC1972-126	TRANSISTOR	
R925			RK73FB2B390J	CHIP R 39 J 1/8W	E1,E2,E3	Q6,7	*		2SC5125-101	TRANSISTOR	
R925			RK73FB2B390J	CHIP R 39 J 1/8W	E4,E5,J	Q8			2SC3421-Q(Y)	TRANSISTOR	
R925			RK73FB2B390J	CHIP R 39 J 1/8W	J2	Q101,102	*		2SC2694-101	TRANSISTOR	
R925			RK73FB2B390J	CHIP R 39 J 1/8W	K1,K2,K3	Q103			2SC3421-Q(Y)	TRANSISTOR	
R925			RK73FB2B680J	CHIP R 68 J 1/8W	J1,J3	Q201	*		IMD2A	TRANSISTOR	
R926			RK73FB2B151J	CHIP R 150 J 1/8W	J1,J3	Q202,203			DTA143EKA	DIGITAL TRANSISTOR	
R928			RK73EB2E000J	CHIP R 0 OHM		Q204,205			DTD123EK	DIGITAL TRANSISTOR	
VR1			R12-6730-05	TRIMMING POT. (220)		Q206			DTC114EKA	DIGITAL TRANSISTOR	
VR2			R12-6737-05	TRIMMING POT. (3.3K)		Q207			DTC143TKA	DIGITAL TRANSISTOR	
VR102			R12-6737-05	TRIMMING POT. (3.3K)		Q208-215			DTB143EK	DIGITAL TRANSISTOR	
VR901			R12-6730-05	TRIMMING POT. (220)		Q216,217	*		IMD2A	TRANSISTOR	
VR902			R12-6737-05	TRIMMING POT. (3.3K)		Q218			2SC2412K(R)	TRANSISTOR	
K1			S76-0424-05	RELAY		Q901			2SK2596	FET	
K201			S76-0429-05	RELAY		Q902			2SK2595-E	FET	
K801,802			S76-0419-25	RELAY		Q903	*		2SC3022-101	TRANSISTOR	
K803			S76-0415-05	RELAY		Q904			2SC3421-Q(Y)	TRANSISTOR	
K804,805			S76-0419-25	RELAY		Q905	*		2SC3102-101	TRANSISTOR	
K806			S76-0415-05	RELAY		TH101,102			157-501-55003	THERMISTOR	
K807,808			S76-0419-25	RELAY		TH201			10KD-5	THERMISTOR	
K809			S76-0415-05	RELAY		TH901			157-153-53002	THERMISTOR	
K810,811			S76-0419-25	RELAY		-			212-1021-05	INSULATING TUBE	
K812			S76-0415-05	RELAY							
K813,814			S76-0419-25	RELAY							
K815			S76-0415-05	RELAY							
K816,817			S76-0419-25	RELAY							
K818			S76-0415-05	RELAY							
K819,820			S76-0419-25	RELAY							

J : TS-2000S J1 : TS-2000V J2 : TS-2000SX J3 : TS-2000VX

K1 : TS-2000 (K) K2 : TS-B2000 (K) K3 : TS-2000X (K)

E1 : TS-2000 (E) E2 : TS-B2000 (E) E3 : TS-2000 (E2) E4 : TS-B2000 (E2) E5 : TS-2000X (E)

PARTS LIST

FILTER UNIT (X51-315X-XX)

Ref. No.	Address	New parts	Parts No.	Description	Destination	Ref. No.	Address	New parts	Parts No.	Description	Destination
FILTER UNIT (X51-315X-XX) 0-00 : J,J2 0-01 : J1,J3						0-11 : K1,K2,K3 2-71 : E1,E2,E3,E4,E5					
C2			C93-0553-05	CHIP C 3.0PF C		C360			CK73FB1H103K	CHIP C 0.010UF K	
C3			C93-0562-05	CHIP C 15PF J		C362			C93-0573-05	CHIP C 120PF J	E1,E2,E3
C5			CK73FB1H103K	CHIP C 0.010UF K		C362			C93-0573-05	CHIP C 120PF J	E4,E5
C7			CK73FB1H102K	CHIP C 1000PF K		C401,402			C93-0573-05	CHIP C 120PF J	
C8			CC73FCH1H680J	CHIP C 68PF J		C403			C93-0569-05	CHIP C 56PF J	E1,E2,E3
C9			C93-0553-05	CHIP C 3.0PF C		C403			C93-0569-05	CHIP C 56PF J	E4,E5
C10			CC73FCH1H560J	CHIP C 56PF J		C403			C93-0572-05	CHIP C 100PF J	J,J1,J2
C11			CK73FB1H102K	CHIP C 1000PF K		C403			C93-0572-05	CHIP C 100PF J	J3
C12-14			CK73FB1H103K	CHIP C 0.010UF K		C403			C93-0572-05	CHIP C 100PF J	K1,K2,K3
C15,16			CC73FCH1H470J	CHIP C 47PF J		C404,405			C93-0573-05	CHIP C 120PF J	
C17-26			CK73FB1H103K	CHIP C 0.010UF K		C406			C93-0565-05	CHIP C 27PF J	E1,E2,E3
C27			CK73FB1H102K	CHIP C 1000PF K		C406			C93-0565-05	CHIP C 27PF J	E4,E5
C28,29			CK73FB1E104K	CHIP C 0.10UF K		C406			C93-0567-05	CHIP C 39PF J	J,J1,J2
C30			CD04AY1E470M	ELECTRO 47UF 25WV		C406			C93-0567-05	CHIP C 39PF J	J3
C31,32			CK73FB1H103K	CHIP C 0.010UF K		C406			C93-0567-05	CHIP C 39PF J	K1,K2,K3
C34			C93-0562-05	CHIP C 15PF J		C407			C93-0566-05	CHIP C 33PF J	J,J1,J2
C35			C93-0565-05	CHIP C 27PF J		C407			C93-0566-05	CHIP C 33PF J	J3
C36			CK73FB1H103K	CHIP C 0.010UF K		C407			C93-0571-05	CHIP C 82PF J	E1,E2,E3
C37			C93-0556-05	CHIP C 6.0PF D		C407			C93-0571-05	CHIP C 82PF J	E4,E5
C38			CC73FCH1H330J	CHIP C 33PF J	E1,E2,E3	C408			CK73FB1H103K	CHIP C 0.010UF K	
C38			CC73FCH1H330J	CHIP C 33PF J	E4,E5,J	C411			C93-0560-05	CHIP C 10PF D	J,J1,J2
C38			CC73FCH1H330J	CHIP C 33PF J	J1,J2,J3	C411			C93-0560-05	CHIP C 10PF D	J3
C201			CM73F2H102J	CHIP C 1000PF J		C411			C93-0560-05	CHIP C 10PF D	K1,K2,K3
C202			CM73F2H561J	CHIP C 560PF J		C451,452			C93-0562-05	CHIP C 15PF J	
C203			CM73F2H102J	CHIP C 1000PF J		C453			C93-0572-05	CHIP C 100PF J	
C204			CM73F2H821J	CHIP C 820PF J		C454			C93-0571-05	CHIP C 82PF J	
C205			C93-0573-05	CHIP C 120PF J		C455			C93-0566-05	CHIP C 33PF J	
C206			CM73F2H102J	CHIP C 1000PF J		C456			C93-0571-05	CHIP C 82PF J	
C207			CK73FB1H103K	CHIP C 0.010UF K		C457			CK73FB1H103K	CHIP C 0.010UF K	
C208,209			C93-0570-05	CHIP C 68PF J		C458			C93-0552-05	CHIP C 2.0PF C	
C251			CM73F2H561J	CHIP C 560PF J		C501			C93-0571-05	CHIP C 82PF J	
C252			C93-0573-05	CHIP C 120PF J		C502			C93-0569-05	CHIP C 56PF J	
C253			CM73F2H102J	CHIP C 1000PF J		C503			C93-0571-05	CHIP C 82PF J	
C255			C93-0573-05	CHIP C 120PF J		C504			C93-0572-05	CHIP C 100PF J	
C256			CM73F2H561J	CHIP C 560PF J		C505			C93-0562-05	CHIP C 15PF J	
C258			CK73FB1H103K	CHIP C 0.010UF K		C506			C93-0570-05	CHIP C 68PF J	
C261			C93-0565-05	CHIP C 27PF J		C507			CK73FB1H103K	CHIP C 0.010UF K	
C262,263			C93-0573-05	CHIP C 120PF J		C508			C93-0555-05	CHIP C 5.0PF C	
C301,302			C93-0572-05	CHIP C 100PF J		C509			C93-0552-05	CHIP C 2.0PF C	
C303,304			CM73F2H471J	CHIP C 470PF J		C551			C93-0558-05	CHIP C 8.0PF D	
C305			C93-0564-05	CHIP C 22PF J		C553			C93-0568-05	CHIP C 47PF J	
C306			CM73F2H331J	CHIP C 330PF J		C554			C93-0559-05	CHIP C 9.0PF D	
C307			CK73FB1H103K	CHIP C 0.010UF K		C555			C93-0569-05	CHIP C 56PF J	
C308			CM73F2H271J	CHIP C 270PF J		C557			C93-0562-05	CHIP C 15PF J	
C311			CM73F2H331J	CHIP C 330PF J		C558			C93-0563-05	CHIP C 18PF J	
C351			C93-0571-05	CHIP C 82PF J	E1,E2,E3	C559,560			CK73FB1H103K	CHIP C 0.010UF K	
C351			C93-0571-05	CHIP C 82PF J	E4,E5	C561			C93-0558-05	CHIP C 8.0PF D	
C353			C93-0568-05	CHIP C 47PF J	E1,E2,E3	C562			C93-0554-05	CHIP C 4.0PF C	
C353			C93-0568-05	CHIP C 47PF J	E4,E5	C563			C93-0553-05	CHIP C 3.0PF C	
C355			CM73F2H471J	CHIP C 470PF J	E1,E2,E3	C601			C93-0555-05	CHIP C 5.0PF C	
C355			CM73F2H471J	CHIP C 470PF J	E4,E5	TC1			C05-0031-15	CERAMIC TRIMMER CAP (10PF)	
C356			C93-0572-05	CHIP C 100PF J	E1,E2,E3	CN2,3		*	E23-1310-05	TEST TERMINAL	
C356			C93-0572-05	CHIP C 100PF J	E4,E5	CN4		*	E04-0154-05	PIN SOCKET	
C357			C93-0573-05	CHIP C 120PF J	E1,E2,E3	CN5-8		*	E23-1310-05	TEST TERMINAL	
C357			C93-0573-05	CHIP C 120PF J	E4,E5	CN9		*	E41-1692-05	PIN ASSY	
C358			CK73FB1H103K	CHIP C 0.010UF K	E1,E2,E3	CN10		*	E41-1690-05	PIN ASSY	
C358			CK73FB1H103K	CHIP C 0.010UF K	E4,E5	CN12,13			E04-0154-05	PIN SOCKET	
						CN20			E04-0154-05	PIN SOCKET	

PARTS LIST

FILTER UNIT (X51-315X-XX)
CONTROL UNIT (X53-391X-XX)

Ref. No.	Address	New parts	Parts No.	Description	Desti-nation	Ref. No.	Address	New parts	Parts No.	Description	Desti-nation
CN21			E04-0190-05	PIN SOCKET		R35			RK73FB2B103J	CHIP R 10K J 1/8W	
-			L92-0104-05	TROIDAL CORE		R36			RK73FB2B332J	CHIP R 3.3K J 1/8W	
-			L92-0107-05	TROIDAL CORE		R37,38			RK73FB2B103J	CHIP R 10K J 1/8W	
-			L92-0108-05	TROIDAL CORE		R39			RK73FB2B101J	CHIP R 100 J 1/8W	
L2,3			L34-1232-15	AIR-CORE COIL		R40			RK73FB2B000J	CHIP R 0.0 J 1/8W	J1,J3
L4			L41-1095-33	SMALL FIXED INDUCTOR (1.UH)		R40			RK73FB2B333J	CHIP R 33K J 1/8W	E1,E2,E3
L5			L34-1088-05	AIR-CORE COIL		R40			RK73FB2B333J	CHIP R 33K J 1/8W	E4,E5,J
L6			L40-1021-12	SMALL FIXED INDUCTOR		R40			RK73FB2B333J	CHIP R 33K J 1/8W	J2
L7			L39-0480-15	TOROIDAL COIL		R40			RK73FB2B333J	CHIP R 33K J 1/8W	K1,K2,K3
L8			L40-1021-12	SMALL FIXED INDUCTOR		R41			RK73FB2B000J	CHIP R 0 OHM	K1,K2,K3
L9			L39-1442-05	TOROIDAL COIL		VR1			R12-6730-05	TRIMMING POT. (220)	
L10			L39-1443-05	TOROIDAL COIL		VR2			R12-6742-05	TRIMMING POT. (22K)	
L11,12			L41-4705-33	SMALL FIXED INDUCTOR (47UH)		K1			S51-1429-05	RELAY	
L13		*	L41-1885-32	SMALL FIXED INDUCTOR (180NH)		K2			S76-0430-05	RELAY	
L14,15		*	L41-4705-33	SMALL FIXED INDUCTOR (47UH)	E1,E2,E3	K3,4			S76-0424-05	RELAY	
L16		*	L41-2775-33	SMALL FIXED INDUCTOR (27NH)	E1,E2,E3	K201,202			S76-0423-05	RELAY	
L16		*	L41-2775-33	SMALL FIXED INDUCTOR (27NH)	E4,E5,J	K251,252			S76-0423-05	RELAY	
L16		*	L41-2775-33	SMALL FIXED INDUCTOR (27NH)	J1,J2,J3	K301,302			S76-0423-05	RELAY	
L201			L41-4705-33	SMALL FIXED INDUCTOR (47UH)		K351,352			S76-0423-05	RELAY	E1,E2,E3
L202			L39-1259-05	TOROIDAL COIL		K351,352			S76-0423-05	RELAY	E4,E5
L203			L39-1260-05	TOROIDAL COIL		K401,402			S76-0423-05	RELAY	
L251			L41-4705-33	SMALL FIXED INDUCTOR (47UH)		K451,452			S76-0423-05	RELAY	
L252			L39-1405-05	TOROIDAL COIL		K501,502			S51-1420-05	RELAY	
L253			L39-1225-05	TOROIDAL COIL		K551,552			S51-1420-05	RELAY	
L301			L41-4705-33	SMALL FIXED INDUCTOR (47UH)		D2			1SS355	DIODE	
L302,303			L39-1457-05	TOROIDAL COIL		D3,4			1SS348-F	DIODE	
L351			L41-4705-33	SMALL FIXED INDUCTOR (47UH)	E1,E2,E3	D5-7			1SS355	DIODE	
L351			L41-4705-33	SMALL FIXED INDUCTOR (47UH)	E4,E5	D8,9			DSA301LA	DIODE	
L352,353			L39-1221-05	TOROIDAL COIL	E1,E2,E3	D10,11			HSM88AS-E	DIODE	
L352,353			L39-1221-05	TOROIDAL COIL	E4,E5	D201			1SS355	DIODE	
L401			L41-4705-33	SMALL FIXED INDUCTOR (47UH)		D251			1SS355	DIODE	
L402-404			L39-1456-05	TOROIDAL COIL		D301			1SS355	DIODE	
L451			L41-4705-33	SMALL FIXED INDUCTOR (47UH)		D351			1SS355	DIODE	E1,E2,E3
L452,453			L34-1279-05	AIR-CORE COIL		D351			1SS355	DIODE	E4,E5
L501			L41-4705-33	SMALL FIXED INDUCTOR (47UH)		D401			1SS355	DIODE	
L502			L34-4661-05	AIR-CORE COIL		D451			1SS355	DIODE	
L503			L34-1282-05	AIR-CORE COIL		D501			1SS355	DIODE	
L551			L41-4705-33	SMALL FIXED INDUCTOR (47UH)		D551			1SS355	DIODE	
L552		*	L34-4662-05	AIR-CORE COIL		IC1		*	TA75S393F-F	IC (COMPARATOR)	
L553			L34-4491-05	AIR-CORE COIL		IC2			TC7WH74FU-F	IC (D FLIP-FLOP)	
L554			L34-1359-05	AIR-CORE COIL		Q1,2			2SK208-F(GR)	FET	
R2,3			R92-1205-05	CHIP R 120 J 1/4W		Q3,4			FMW1	TRANSISTOR	
R5			RK73FB2B100J	CHIP R 10 J 1/8W		CONTROL UNIT (X53-391X-XX) 0-00 : J,J2					
R6			RK73RB2H330J	CHIP R 33 J 1/2W		0-01 : J1,J3 0-11 : K1,K2,K3 2-71 : E1,E2,E5 2-72 : E3,E4					
R7		*	RK73RB2H270J	CHIP R 27 J 1/2W		C1-7			CK73GB1H102K	CHIP C 1000PF K	
R8			R92-1316-05	CHIP R 39 J 1W		C8-11			CK73GB1C104K	CHIP C 0.10UF K	
R9,10			RK73FB2B101J	CHIP R 100 J 1/8W		C12-15			CC73GCH1H101J	CHIP C 100PF J	
R11-14			RK73FB2B104J	CHIP R 100K J 1/8W		C16,17			CK73GB1C104K	CHIP C 0.10UF K	
R15,16			RK73FB2B102J	CHIP R 1.0K J 1/8W		C18			CK73GB1H103K	CHIP C 0.010UF K	
R17,18			RK73FB2B101J	CHIP R 100 J 1/8W		C19		*	C92-0889-05	ELECTRO 330UF 6.3WV	
R19,20			RK73FB2B104J	CHIP R 100K J 1/8W		C20,21			CK73GB1C104K	CHIP C 0.10UF K	
R21,22			RK73FB2B103J	CHIP R 10K J 1/8W		C22			CK73GB1H103K	CHIP C 0.010UF K	
R23,24			RK73FB2B152J	CHIP R 1.5K J 1/8W		C23,24			CK73GB1C104K	CHIP C 0.10UF K	
R25,26			RK73FB2B102J	CHIP R 1.0K J 1/8W		C25			CK73GB1H103K	CHIP C 0.010UF K	
R27,28			RK73FB2B332J	CHIP R 3.3K J 1/8W							
R29,30			RK73FB2B121J	CHIP R 120 J 1/8W							
R31,32			RK73FB2B122J	CHIP R 1.2K J 1/8W							
R33			RK73FB2B103J	CHIP R 10K J 1/8W							
R34			RK73FB2B332J	CHIP R 3.3K J 1/8W							

J : TS-2000S J1 : TS-2000V J2 : TS-2000SX J3 : TS-2000VX
K1 : TS-2000 (K) K2 : TS-B2000 (K) K3 : TS-2000X (K)
E1 : TS-2000 (E) E2 : TS-B2000 (E) E3 : TS-2000 (E2) E4 : TS-B2000 (E2) E5 : TS-2000X (E)

PARTS LIST

CONTROL UNIT (X53-391X-XX)

Ref. No.	Address	New parts	Parts No.	Description	Destination	Ref. No.	Address	New parts	Parts No.	Description	Destination
C26		*	C92-0879-05	ELECTRO 10UF 10WV		C504-507			CK73GB1H103K	CHIP C 0.010UF K	
C27			CS77AAQJ100M	CHIP TNTL 10UF 6.3WV		C508		*	C92-0878-05	ELECTRO 100UF 6.3WV	
C28-33			CK73GB1H103K	CHIP C 0.010UF K		C509-519			CK73GB1H103K	CHIP C 0.010UF K	
C34,35			CC73GCH1H100D	CHIP C 10PF D		C520			CK73GB1C104K	CHIP C 0.10UF K	
C36-44			CK73GB1H103K	CHIP C 0.010UF K		C521			CK73GB1H103K	CHIP C 0.010UF K	
C45-48			CK73GB1H102K	CHIP C 1000PF K		C522			CK73GB1C104K	CHIP C 0.10UF K	
C49			CK73GB1C104K	CHIP C 0.10UF K		C523		*	C92-0878-05	ELECTRO 100UF 6.3WV	
C50-62			CK73GB1H102K	CHIP C 1000PF K		C524,525			CK73GB1H103K	CHIP C 0.010UF K	
C64			CK73GB1C104K	CHIP C 0.10UF K		C526			CK73GB1C104K	CHIP C 0.10UF K	
C66-79			CK73GB1H103K	CHIP C 0.010UF K		C527			CK73GB1H103K	CHIP C 0.010UF K	
C80-83			CK73GB1H102K	CHIP C 1000PF K		C528,529			CK73GB1C104K	CHIP C 0.10UF K	
C84-86			CC73GCH1H101J	CHIP C 100PF J		C530,531			CK73GB1H103K	CHIP C 0.010UF K	
C87-91			CK73GB1H102K	CHIP C 1000PF K		C532			CK73GB1C104K	CHIP C 0.10UF K	
C92			CC73GCH1H101J	CHIP C 100PF J		C533,534			CC73GCH1H100D	CHIP C 10PF D	
C93,94			CK73GB1H102K	CHIP C 1000PF K		C535			CK73GB1C104K	CHIP C 0.10UF K	
C95-98			CC73GCH1H101J	CHIP C 100PF J		C536			CK73GB1H103K	CHIP C 0.010UF K	
C99,100			CK73GB1H102K	CHIP C 1000PF K		C537			CK73GB1C104K	CHIP C 0.10UF K	
C101-110			CC73GCH1H101J	CHIP C 100PF J		C538		*	C92-0878-05	ELECTRO 100UF 6.3WV	
C111			CK73GB1H103K	CHIP C 0.010UF K		C539,540			CK73GB1H103K	CHIP C 0.010UF K	
C112-127			CK73GB1H102K	CHIP C 1000PF K		C541			CK73GB1C104K	CHIP C 0.10UF K	
C128-139			CC73GCH1H101J	CHIP C 100PF J		C542			CK73GB1H103K	CHIP C 0.010UF K	
C140-143			CK73GB1H102K	CHIP C 1000PF K		C543,544			CK73GB1C104K	CHIP C 0.10UF K	
C145			CK73GB1C104K	CHIP C 0.10UF K		C545,546			CK73GB1H103K	CHIP C 0.010UF K	
C147,148			CC73GCH1H160J	CHIP C 16PF J		C547			CK73GB1C104K	CHIP C 0.10UF K	
C149			CK73GB1C104K	CHIP C 0.10UF K		C548,549			CC73GCH1H100D	CHIP C 10PF D	
C150			CK73GB1H103K	CHIP C 0.010UF K		C550			CK73GB1H103K	CHIP C 0.010UF K	
C151			CK73GB1C104K	CHIP C 0.10UF K		C551,552			CK73GB1H102K	CHIP C 1000PF K	
C152			CK73FB1A105K	CHIP C 1.0UF K		C553,554			CK73GB1C104K	CHIP C 0.10UF K	
C153,154			CK73GB1C104K	CHIP C 0.10UF K		C555,556		*	C92-0879-05	ELECTRO 10UF 10WV	
C155			CK73GB1E223K	CHIP C 0.022UF K		C557,558			CK73GB1C104K	CHIP C 0.10UF K	
C156			CC73GCH1H221J	CHIP C 220PF J		C559			CC73GCH1H100D	CHIP C 10PF D	
C157			CK73GB1H222K	CHIP C 2200PF K		C560,561			CK73GB1H103K	CHIP C 0.010UF K	
C158			CK73GB1C104K	CHIP C 0.10UF K		C562			CC73GCH1H100D	CHIP C 10PF D	
C159			CK73GB1H682K	CHIP C 6800PF K		C563		*	C92-0878-05	ELECTRO 100UF 6.3WV	
C160			CK73GB1E223K	CHIP C 0.022UF K		C564			CK73GB1H103K	CHIP C 0.010UF K	
C161			CK73GB1H102K	CHIP C 1000PF K		C565			CS77AAQJ100M	CHIP TNTL 10UF 6.3WV	
C162			CK73GB1H103K	CHIP C 0.010UF K		C566,567			CS77AAQJ4R7M	CHIP TNTL 4.7UF 6.3WV	
C163			CK73GB1H682K	CHIP C 6800PF K		C568-570			CK73GB1C104K	CHIP C 0.10UF K	
C164			CK73GB1E223K	CHIP C 0.022UF K		C571,572			CS77AAQJ4R7M	CHIP TNTL 4.7UF 6.3WV	
C165			CK73GB1H682K	CHIP C 6800PF K		C573-575			CK73GB1C104K	CHIP C 0.10UF K	
C166			CK73GB1H471K	CHIP C 470PF K		C576,577			CK73GB1H222K	CHIP C 2200PF K	
C167			CC73GCH1H101J	CHIP C 100PF J		C578			CS77AAQJ100M	CHIP TNTL 10UF 6.3WV	
C168			CK73GB1H472K	CHIP C 4700PF K		C579,580			CS77AAQJ4R7M	CHIP TNTL 4.7UF 6.3WV	
C169			CK73GB1H103K	CHIP C 0.010UF K		C581-583			CK73GB1C104K	CHIP C 0.10UF K	
C170			CK73GB1H471K	CHIP C 470PF K		C584,585			CS77AAQJ4R7M	CHIP TNTL 4.7UF 6.3WV	
C171			CK73GB1C104K	CHIP C 0.10UF K		C586-588			CK73GB1C104K	CHIP C 0.10UF K	
C172,173			CK73FB1A105K	CHIP C 1.0UF K		C589,590			CK73GB1H222K	CHIP C 2200PF K	
C174			CK73GB1H103K	CHIP C 0.010UF K		C591			CK73GB1H272K	CHIP C 2700PF K	
C175			CK73GB1C473K	CHIP C 0.047UF K		C592,593			CC73GCH1H331J	CHIP C 330PF J	
C176,177			CK73GB1C104K	CHIP C 0.10UF K		C594			CK73GB1H103K	CHIP C 0.010UF K	
C178,179			CK73GB1H102K	CHIP C 1000PF K		C595			CS77AAQJ100M	CHIP TNTL 10UF 6.3WV	
C180			C92-0523-05	CHIP-ELE 10UF 16WV		C596			CK73GB1C104K	CHIP C 0.10UF K	
C181			CK73GB1C473K	CHIP C 0.047UF K		C599			CS77AAQJ100M	CHIP TNTL 10UF 6.3WV	
C182,183			CK73GB1C104K	CHIP C 0.10UF K		C600			CK73GB1H103K	CHIP C 0.010UF K	
C185			CK73FB1A105K	CHIP C 1.0UF K		C601			CS77AAQJ100M	CHIP TNTL 10UF 6.3WV	
C186			CK73GB1C104K	CHIP C 0.10UF K		C602			CK73GB1C104K	CHIP C 0.10UF K	
C187			CK73GB1H102K	CHIP C 1000PF K		C603			CS77AAQJ100M	CHIP TNTL 10UF 6.3WV	
C188			CK73GB1C104K	CHIP C 0.10UF K		C604			CC73GCH1H151J	CHIP C 150PF J	
C501,502			CK73GB1C104K	CHIP C 0.10UF K		C605			CK73GB1H152K	CHIP C 1500PF K	
C503		*	C92-0878-05	ELECTRO 100UF 6.3WV		C606			CS77AAQJ100M	CHIP TNTL 10UF 6.3WV	

PARTS LIST

CONTROL UNIT (X53-391X-XX)

Ref. No.	Address	New parts	Parts No.	Description	Desti-nation	Ref. No.	Address	New parts	Parts No.	Description	Desti-nation
C607			CK73GB1H103K	CHIP C 0.010UF K		CN3		*	E41-1686-05	PIN ASSY	
C608			CS77AAQJ100M	CHIP TNTL 10UF 6.3WV		CN4			E40-5978-05	FLAT CABLE CONNECTOR	
C609			CK73GB1C104K	CHIP C 0.10UF K		CN5			E40-6074-05	FLAT CABLE CONNECTOR	
C610			CS77AAQJ100M	CHIP TNTL 10UF 6.3WV		CN6		*	E40-6676-05	FLAT CABLE CONNECTOR	
C611			CK73GB1H471K	CHIP C 470PF K		CN7			E40-5744-05	FLAT CABLE CONNECTOR	
C612			CK73GB1H472K	CHIP C 4700PF K		CN503		*	E41-1687-05	PIN ASSY	
C613			CK73GB1H103K	CHIP C 0.010UF K		CN504		*	E40-6676-05	FLAT CABLE CONNECTOR	
C614			CK73GB1H102K	CHIP C 1000PF K		CN505		*	E41-1684-05	PIN ASSY	
C615,616			CS77AAQJ100M	CHIP TNTL 10UF 6.3WV		CN506		*	E41-1686-05	PIN ASSY	
C617			CK73GB1C104K	CHIP C 0.10UF K		L1,2			L33-0742-05	SMALL FIXED INDUCTOR	
C618			CS77AAQJ100M	CHIP TNTL 10UF 6.3WV		L3,4			L92-0137-05	CHIP FERRITE	
C619			CK73GB1H103K	CHIP C 0.010UF K		L5-8		*	L41-1005-39	SMALL FIXED INDUCTOR (10U)	
C620			CS77AAQJ100M	CHIP TNTL 10UF 6.3WV		L9			L92-0137-05	CHIP FERRITE	
C621			CK73GB1C104K	CHIP C 0.10UF K		L10,11			L33-0742-05	SMALL FIXED INDUCTOR	
C622,623			CS77AAQJ100M	CHIP TNTL 10UF 6.3WV		L13		*	L41-1005-39	SMALL FIXED INDUCTOR (10U)	
C624			CK73GB1H103K	CHIP C 0.010UF K		L14			L33-0742-05	SMALL FIXED INDUCTOR	
C625			CK73GB1H102K	CHIP C 1000PF K		L15-17		*	L41-1005-39	SMALL FIXED INDUCTOR (10U)	
C626			CK73GB1H103K	CHIP C 0.010UF K		L502			L33-0742-05	SMALL FIXED INDUCTOR	
C627			CK73GB1H102K	CHIP C 1000PF K		L504-508		*	L41-1005-39	SMALL FIXED INDUCTOR (10U)	
C628,629			CS77AAQJ100M	CHIP TNTL 10UF 6.3WV		X1			L77-1680-05	CRYSTAL RESONATOR (11.0592MHZ)	
C630			CK73GB1H103K	CHIP C 0.010UF K		X2			L78-0459-05	RESONATOR (4.19MHZ)	
C631			CS77AAQJ100M	CHIP TNTL 10UF 6.3WV		X3		*	L77-3012-05	CRYSTAL RESONATOR (7.9872MHZ)	
C632			CK73GB1C104K	CHIP C 0.10UF K		X501,502			L77-1680-05	CRYSTAL RESONATOR (11.0592MHZ)	
C633,634			CS77AAQJ100M	CHIP TNTL 10UF 6.3WV		X503			L77-1679-05	CRYSTAL RESONATOR (12.288MHZ)	
C635			CK73GB1H103K	CHIP C 0.010UF K		CP1,2			RK74GB1J101J	CHIP-COM 100 J 1/16W	
C636			CK73GB1H102K	CHIP C 1000PF K		CP3-16			RK74GB1J473J	CHIP-COM 47K J 1/16W	
C637			CK73GB1H472K	CHIP C 4700PF K		CP18-33			RK74GB1J101J	CHIP-COM 100 J 1/16W	
C638			CK73GB1H471K	CHIP C 470PF K		CP501-503			RK74GB1J473J	CHIP-COM 47K J 1/16W	
C639-641			CS77AAQJ100M	CHIP TNTL 10UF 6.3WV		CP504-508			RK74GB1J101J	CHIP-COM 100 J 1/16W	
C642			CK73GB1C104K	CHIP C 0.10UF K		R1,2			RK73GB2A472J	CHIP R 4.7K J 1/10W	
C643			CK73GB1H103K	CHIP C 0.010UF K		R3			RK73GB2A103J	CHIP R 10K J 1/10W	
C644			CS77AAQJ100M	CHIP TNTL 10UF 6.3WV		R5			RK73GB2A473J	CHIP R 47K J 1/10W	
C645			CK73GB1C104K	CHIP C 0.10UF K		R7			RK73RB2H330J	CHIP R 33 J 1/2W	
C646,647			CS77AAQJ100M	CHIP TNTL 10UF 6.3WV		R9,10			RK73GB2A473J	CHIP R 47K J 1/10W	
C648			CK73GB1H681K	CHIP C 680PF K		R11,12			RK73GB2A102J	CHIP R 1.0K J 1/10W	
C649			CK73GB1H682K	CHIP C 6800PF K		R13-17			RK73GB2A473J	CHIP R 47K J 1/10W	
C650			CK73GB1H103K	CHIP C 0.010UF K		R19-26			RK73GB2A473J	CHIP R 47K J 1/10W	
C651-655			CK73GB1C104K	CHIP C 0.10UF K		R28			RK73GB2A101J	CHIP R 100 J 1/10W	
C656,657			CK73GB1E223K	CHIP C 0.022UF K		R45			RK73GB2A473J	CHIP R 47K J 1/10W	
C658			CK73GB1H102K	CHIP C 1000PF K		R46			RK73GB2A105J	CHIP R 1.0M J 1/10W	
C659			CS77CA1C010M	CHIP TNTL 1.0UF 16WV		R47			RK73GB2A000J	CHIP R 0.0 J 1/10W	E3,E4
C660-673			CK73GB1H102K	CHIP C 1000PF K		R48			RK73GB2A000J	CHIP R 0.0 J 1/10W	E1,E2,E5
C674			CC73GCH1H101J	CHIP C 100PF J		R50-54			RK73GB2A000J	CHIP R 0.0 J 1/10W	J,J1,J2
C675-678			CK73GB1H102K	CHIP C 1000PF K		R50-54			RK73GB2A000J	CHIP R 0.0 J 1/10W	J3
C700		*	C92-0879-05	ELECTRO 10UF 10WV		R52-54			RK73GB2A000J	CHIP R 0.0 J 1/10W	E1,E2,E3
C701			CK73GB1C104K	CHIP C 0.10UF K		R52-54			RK73GB2A000J	CHIP R 0.0 J 1/10W	E4,E5
C702			CS77AAQJ100M	CHIP TNTL 10UF 6.3WV		R52,53			RK73GB2A000J	CHIP R 0.0 J 1/10W	K1,K2,K3
C703			CK73GB1C104K	CHIP C 0.10UF K		R55-58			RK73GB2A101J	CHIP R 100 J 1/10W	
C704			CS77AAQJ100M	CHIP TNTL 10UF 6.3WV		R67			RK73GB2A101J	CHIP R 100 J 1/10W	
C705			CK73FB1A105K	CHIP C 1.0UF K		R100			RK73GB2A101J	CHIP R 100 J 1/10W	
C708			CK73FB1A105K	CHIP C 1.0UF K		R101			RK73GB2A471J	CHIP R 470 J 1/10W	
C711-714			CK73GB1H102K	CHIP C 1000PF K		R114			RK73GB2A101J	CHIP R 100 J 1/10W	
C715			CS77AAQJ4R7M	CHIP TNTL 4.7UF 6.3WV		R117			RK73GB2A101J	CHIP R 100 J 1/10W	
C716		*	C92-0879-05	ELECTRO 10UF 10WV		R120			RK73GB2A104J	CHIP R 100K J 1/10W	
C717			CK73GB1H102K	CHIP C 1000PF K		R121,122			RK73GB2A000J	CHIP R 0.0 J 1/10W	
C718			CC73GCH1H220J	CHIP C 22PF J		R124			RK73GB2A103J	CHIP R 10K J 1/10W	
C719-728			CK73GB1H102K	CHIP C 1000PF K		R125			RK73GB2A102J	CHIP R 1.0K J 1/10W	
C729			CS77AAQJ100M	CHIP TNTL 10UF 6.3WV		R126			RK73GB2A103J	CHIP R 10K J 1/10W	
CN1			E40-5762-05	FLAT CABLE CONNECTOR		R127			RK73GB2A472J	CHIP R 4.7K J 1/10W	

J : TS-2000S J1 : TS-2000V J2 : TS-2000SX J3 : TS-2000VX

K1 : TS-2000 (K) K2 : TS-B2000 (K) K3 : TS-2000X (K)

E1 : TS-2000 (E) E2 : TS-B2000 (E) E3 : TS-2000 (E2) E4 : TS-B2000 (E2) E5 : TS-2000X (E)

PARTS LIST

CONTROL UNIT (X53-391X-XX)

Ref. No.	Address	New parts	Parts No.	Description	Destination	Ref. No.	Address	New parts	Parts No.	Description	Destination
R128			RK73GB2A103J	CHIP R 10K J 1/10W		R517		*	R92-3612-05	METAL GLAZE RESISTOR	
R129			RK73GB2A000J	CHIP R 0.0 J 1/10W		R518		*	R92-3611-05	METAL GLAZE RESISTOR	
R130			RK73GB2A103J	CHIP R 10K J 1/10W		R519,520		*	R92-3612-05	METAL GLAZE RESISTOR	
R131			RK73GB2A104J	CHIP R 100K J 1/10W		R521		*	R92-3611-05	METAL GLAZE RESISTOR	
R132			RK73GB2A103J	CHIP R 10K J 1/10W		R522,523		*	R92-3612-05	METAL GLAZE RESISTOR	
R133,134			RK73GB2A332J	CHIP R 3.3K J 1/10W		R524		*	R92-3611-05	METAL GLAZE RESISTOR	
R135,136			RK73GB2A123J	CHIP R 12K J 1/10W		R525,526		*	R92-3612-05	METAL GLAZE RESISTOR	
R137			RK73GB2A393J	CHIP R 39K J 1/10W		R527		*	R92-3611-05	METAL GLAZE RESISTOR	
R138			RK73GB2A103J	CHIP R 10K J 1/10W		R528		*	R92-3612-05	METAL GLAZE RESISTOR	
R139			RK73GB2A222J	CHIP R 2.2K J 1/10W		R529-531		*	R92-3611-05	METAL GLAZE RESISTOR	
R140			RK73GB2A823J	CHIP R 82K J 1/10W		R532		*	R92-3612-05	METAL GLAZE RESISTOR	
R141			RK73GB2A103J	CHIP R 10K J 1/10W		R533-536			RK73GB2A473J	CHIP R 47K J 1/10W	
R142,143			RK73GB2A123J	CHIP R 12K J 1/10W		R537			RK73GB2A000J	CHIP R 0.0 J 1/10W	
R144			RK73GB2A103J	CHIP R 10K J 1/10W		R538-540			RK73GB2A103J	CHIP R 10K J 1/10W	E1,E2,E3
R145			RK73GB2A123J	CHIP R 12K J 1/10W		R538-540			RK73GB2A103J	CHIP R 10K J 1/10W	E4,E5
R146			RK73GB2A473J	CHIP R 47K J 1/10W		R538-540			RK73GB2A103J	CHIP R 10K J 1/10W	K1,K2,K3
R147			RK73GB2A683J	CHIP R 68K J 1/10W		R538,539			RK73GB2A103J	CHIP R 10K J 1/10W	J,J1,J2
R148			RK73GB2A332J	CHIP R 3.3K J 1/10W		R538,539			RK73GB2A103J	CHIP R 10K J 1/10W	J3
R149			RK73GB2A104J	CHIP R 100K J 1/10W		R541-550			RK73GB2A000J	CHIP R 0.0 J 1/10W	
R150			RK73GB2A103J	CHIP R 10K J 1/10W		R552,553			RK73GB2A103J	CHIP R 10K J 1/10W	
R151			RK73GB2A104J	CHIP R 100K J 1/10W		R554,555			RK73GB2A101J	CHIP R 100 J 1/10W	
R152,153			RK73GB2A223J	CHIP R 22K J 1/10W		R557			RK73GB2A000J	CHIP R 0.0 J 1/10W	
R154			RK73GB2A102J	CHIP R 1.0K J 1/10W		R558			RK73GB2A101J	CHIP R 100 J 1/10W	
R155			RK73GB2A272J	CHIP R 2.7K J 1/10W		R559-561			RK73GB2A103J	CHIP R 10K J 1/10W	
R157			RK73GB2A104J	CHIP R 100K J 1/10W		R563			RK73GB2A103J	CHIP R 10K J 1/10W	
R158			RK73GB2A563J	CHIP R 56K J 1/10W		R565,566			RK73GB2A472J	CHIP R 4.7K J 1/10W	
R159			RK73GB2A272J	CHIP R 2.7K J 1/10W		R567			RK73GB2A474J	CHIP R 470K J 1/10W	
R160			RK73GB2A102J	CHIP R 1.0K J 1/10W		R568			RK73GB2A473J	CHIP R 47K J 1/10W	
R161			RK73GB2A103J	CHIP R 10K J 1/10W		R570,571			RK73GB2A103J	CHIP R 10K J 1/10W	
R162,163			RK73GB2A102J	CHIP R 1.0K J 1/10W		R572,573			RK73GB2A101J	CHIP R 100 J 1/10W	
R164,165			RK73GB2A473J	CHIP R 47K J 1/10W		R575			RK73GB2A000J	CHIP R 0.0 J 1/10W	
R186-188			RK73GB2A101J	CHIP R 100 J 1/10W		R576			RK73GB2A101J	CHIP R 100 J 1/10W	
R200			RK73GB2A000J	CHIP R 0.0 J 1/10W		R577-581			RK73GB2A103J	CHIP R 10K J 1/10W	
R201-204			RK73GB2A473J	CHIP R 47K J 1/10W		R582,583			RK73GB2A472J	CHIP R 4.7K J 1/10W	
R206,207			RK73GB2A473J	CHIP R 47K J 1/10W		R584			RK73GB2A474J	CHIP R 470K J 1/10W	
R209-211			RK73GB2A473J	CHIP R 47K J 1/10W		R585,586			RK73GB2A104J	CHIP R 100K J 1/10W	
R213			RK73GB2A104J	CHIP R 100K J 1/10W		R588,589			RK73GB2A103J	CHIP R 10K J 1/10W	
R214			RK73GB2A473J	CHIP R 47K J 1/10W		R590,591			RK73GB2A100J	CHIP R 10 J 1/10W	
R215			RK73GB2A104J	CHIP R 100K J 1/10W		R592			RK73GB2A103J	CHIP R 10K J 1/10W	
R216,217			RK73GB2A473J	CHIP R 47K J 1/10W		R593			RK73GB2A100J	CHIP R 10 J 1/10W	
R218			RK73GB2A474J	CHIP R 470K J 1/10W		R594,595			RK73GB2A103J	CHIP R 10K J 1/10W	
R219			RK73GB2A104J	CHIP R 100K J 1/10W		R596			RK73GB2A562J	CHIP R 5.6K J 1/10W	
R220			RK73GB2A000J	CHIP R 0.0 J 1/10W		R597			RK73GB2A103J	CHIP R 10K J 1/10W	
R221,222			RK73GB2A473J	CHIP R 47K J 1/10W		R598			RK73GB2A562J	CHIP R 5.6K J 1/10W	
R223			RK73GB2A183J	CHIP R 18K J 1/10W		R599			RK73GB2A103J	CHIP R 10K J 1/10W	
R224			RK73GB2A103J	CHIP R 10K J 1/10W		R600,601			RK73GB2A472J	CHIP R 4.7K J 1/10W	
R225			RK73GB2A000J	CHIP R 0.0 J 1/10W		R602			RK73GB2A104J	CHIP R 100K J 1/10W	
R226			RK73GB2A222J	CHIP R 2.2K J 1/10W		R603			RK73GB2A221J	CHIP R 220 J 1/10W	
R227			RK73FB2B000J	CHIP R 0.0 J 1/8W	J,J1,J2	R604			RK73GB2A103J	CHIP R 10K J 1/10W	
R227			RK73FB2B000J	CHIP R 0.0 J 1/8W	J3	R605			RK73GB2A104J	CHIP R 100K J 1/10W	
R228			RK73GB2A473J	CHIP R 47K J 1/10W		R606			RK73GB2A332J	CHIP R 3.3K J 1/10W	
R501,502		*	R92-3611-05	METAL GLAZE RESISTOR		R607,608			RK73GB2A472J	CHIP R 4.7K J 1/10W	
R503,504		*	R92-3612-05	METAL GLAZE RESISTOR		R610			RK73GB2A331J	CHIP R 330 J 1/10W	
R505		*	R92-3611-05	METAL GLAZE RESISTOR		R611,612			RK73GB2A472J	CHIP R 4.7K J 1/10W	
R506,507		*	R92-3612-05	METAL GLAZE RESISTOR		R613,614			RK73GB2A223J	CHIP R 22K J 1/10W	
R508		*	R92-3611-05	METAL GLAZE RESISTOR		R616			RK73GB2A223J	CHIP R 22K J 1/10W	
R509,510		*	R92-3612-05	METAL GLAZE RESISTOR		R618			RK73GB2A331J	CHIP R 330 J 1/10W	
R511		*	R92-3611-05	METAL GLAZE RESISTOR		R619			RK73GB2A332J	CHIP R 3.3K J 1/10W	
R512,513		*	R92-3612-05	METAL GLAZE RESISTOR		R620,621			RK73GB2A472J	CHIP R 4.7K J 1/10W	
R514-516		*	R92-3611-05	METAL GLAZE RESISTOR		R623,624			RK73GB2A472J	CHIP R 4.7K J 1/10W	

PARTS LIST

CONTROL UNIT (X53-391X-XX)

Ref. No.	Address	New parts	Parts No.	Description	Desti-nation	Ref. No.	Address	New parts	Parts No.	Description	Desti-nation
R625-630			RK73GB2A223J	CHIP R 22K J 1/10W		D12			MA2S111-F	DIODE	K1,K2,K3
R631			RK73GB2A561J	CHIP R 560 J 1/10W		D13			02D28.2F-Y	ZENER DIODE	
R632-635			RK73GB2A472J	CHIP R 4.7K J 1/10W		D14-17			MA2S111-F	DIODE	
R636,637			RK73GB2A223J	CHIP R 22K J 1/10W		D501-504			DAN202U	DIODE	
R638			RK73GB2A561J	CHIP R 560 J 1/10W		IC1	*		M62003FPCFOJ	IC (RESET)	
R639,640			RK73GB2A223J	CHIP R 22K J 1/10W		IC2,3			TA7805FQ	IC (AVR)	
R641			RK73GB2A103J	CHIP R 10K J 1/10W		IC4	*		XC62FP3302PN	IC (3.3V AVR FOR DSP)	
R642			RK73GB2A223J	CHIP R 22K J 1/10W		IC5			TC74HC4053AFT	IC (ANALOG SWITCH)	
R643			RK73GB2A221J	CHIP R 220 J 1/10W		IC6			TC74HC4052AFT	IC (ANALOG SWITCH)	
R644,645			RK73GB2A472J	CHIP R 4.7K J 1/10W		IC7	*		AT25128A10SU27	IC (EEPROM)	
R646			RK73GB2A103J	CHIP R 10K J 1/10W		IC8	*		64F2633JXUC	IC (MAIN MICROCOMPUTER)	E1,E2,E3
R647			RK73GB2A223J	CHIP R 22K J 1/10W		IC8	*		64F2633JXUC	IC (MAIN MICROCOMPUTER)	E4,E5
R648			RK73GB2A221J	CHIP R 220 J 1/10W		IC8	*		64F2633JXUC	IC (MAIN MICROCOMPUTER)	K1,K2,K3
R649,650			RK73GB2A223J	CHIP R 22K J 1/10W		IC8	*		64F2633JXVC	IC (MAIN MICROCOMPUTER)	J,J2
R651			RK73GB2A472J	CHIP R 4.7K J 1/10W		IC8	*		64F2633JXZC	IC (MAIN MICROCOMPUTER)	J1,J3
R652,653			RK73GB2A223J	CHIP R 22K J 1/10W		IC9-11	*		TC7LVX4245FSF	IC (CONVERSION BETWEEN 5V AND3V)	
R654-659			RK73GB2A472J	CHIP R 4.7K J 1/10W		IC12	*		LC73881M-E	IC (DTMF DECODER)	
R660,661			RK73GB2A223J	CHIP R 22K J 1/10W		IC13			TC74VHC08FT	IC (INPUT/OUTPUT PORT LOGIC)	
R662			RK73GB2A472J	CHIP R 4.7K J 1/10W		IC14			TC74VHC32FT	IC (INPUT/OUTPUT PORT LOGIC)	
R663			RK73GB2A223J	CHIP R 22K J 1/10W		IC15			TC74VHC04FT	IC (INPUT/OUTPUT PORT LOGIC)	
R664			RK73GB2A103J	CHIP R 10K J 1/10W		IC16-18			TC74VHC08FT	IC (INPUT/OUTPUT PORT LOGIC)	
R665			RK73GB2A472J	CHIP R 4.7K J 1/10W		IC19-25			TC74VHC573FT	IC (INPUT/OUTPUT PORT)	
R666,667			RK73GB2A222J	CHIP R 2.2K J 1/10W		IC26			TMT0111Q	IC (TNC MICROCOMPUTER)	
R668			RK73GB2A223J	CHIP R 22K J 1/10W		IC27	*		TA75W393FU-F	IC (OP AMP)	
R669,670			RK73GB2A334J	CHIP R 330K J 1/10W		IC28			TGT0210Q	IC (TNC LOGIC CIRCUIT)	
R671			RK73GB2A223J	CHIP R 22K J 1/10W		IC29			TA75W01FUF	IC (OP AMP)	
R672,673			RK73GB2A102J	CHIP R 1.0K J 1/10W		IC30	*		TA75S393F-F	IC (COMPARATOR)	
R674			RK73GB2A472J	CHIP R 4.7K J 1/10W		IC31	*		TC7SH08FU-F	IC (AND)	
R686-688			RK73GB2A000J	CHIP R 0.0 J 1/10W		IC32,33			PST9130NR	IC (RESET IC)	
R693-699			RK73GB2A000J	CHIP R 0.0 J 1/10W		IC501	*		TA48M033F-F	IC (AVR)	
R700			RK73GB2A473J	CHIP R 47K J 1/10W		IC502,503	*		XC62FP1802PN	IC (1.8V AVR FOR DSP)	
R701			RK73GB2A154J	CHIP R 150K J 1/10W		IC504	*		29AL08D90KBHA	IC (FLASH ROM FOR DSP2)	
R702			RK73GB2A103J	CHIP R 10K J 1/10W		IC505,506			TC74VHC573FT	IC (FOR DSP PORT OUTPUT)	
R703-706			RK73GB2A472J	CHIP R 4.7K J 1/10W		IC507			TC74VHC02FT	IC (INPUT/OUTPUT PORT LOGIC)	
R707			RK73GB2A104J	CHIP R 100K J 1/10W		IC508	*		29AL08D90KBFA	IC (FLASH ROM FOR DSP1)	E1,E2,E3
R709,710			RK73GB2A104J	CHIP R 100K J 1/10W		IC508	*		29AL08D90KBFA	IC (FLASH ROM FOR DSP1)	E4,E5
R712			RK73GB2A104J	CHIP R 100K J 1/10W		IC508	*		29AL08D90KBFA	IC (FLASH ROM FOR DSP1)	K1,K2,K3
R714-716			RK73GB2A470J	CHIP R 47 J 1/10W		IC508	*		29AL08D90KBGA	IC (FLASH ROM FOR DSP1)	J,J1,J2
R717			RK73GB2A000J	CHIP R 0.0 J 1/10W		IC508	*		29AL08D90KBGA	IC (FLASH ROM FOR DSP1)	J3
R718,719			RK73GB2A473J	CHIP R 47K J 1/10W		IC509			TC74VHC32FT	IC (INPUT/OUTPUT PORT LOGIC)	
R720,721			RK73GB2A104J	CHIP R 100K J 1/10W		IC510	*		TC7WU04FU-F	IC (INPUT/OUTPUT PORT LOGIC)	
R722,723			RK73GB2A000J	CHIP R 0.0 J 1/10W		IC511			TC74VHC08FT	IC (INPUT/OUTPUT PORT LOGIC)	
R725			RK73GB2A000J	CHIP R 0.0 J 1/10W		IC512			TC74VHC573FT	IC (FOR DSP PORT INPUT)	
R731			RK73GB2A000J	CHIP R 0.0 J 1/10W		IC513			TC74VHC32FT	IC (INPUT/OUTPUT PORT LOGIC)	
R736			RK73GB2A000J	CHIP R 0.0 J 1/10W		IC514			TC74VHC573FT	IC (FOR DSP PORT INPUT)	
R738			RK73GB2A561J	CHIP R 560 J 1/10W		IC515,516			320VC5402PGE	IC (DSP)	
R739			RK73GB2A124J	CHIP R 120K J 1/10W		IC517			NJM2904V-ZB	IC (ANALOG AGC BUFFER)	
R740			RK73RB2H100J	CHIP R 10 J 1/2W		IC518			AK4524	IC (CODEC 24BIT)	
R741			RK73GB2A104J	CHIP R 100K J 1/10W		IC519			TC7W74FU-F	IC (FOR CODEC CLOCK DIVISION)	
R742,743			RK73GB2A473J	CHIP R 47K J 1/10W		IC520	*		TC7WU04FU-F	IC (FOR CODEC CLOCK DIVISION)	
R744			RK73GB2A103J	CHIP R 10K J 1/10W	J,J1,J2	IC521			TC74VHC4040FT	IC (FOR CODEC CLOCK DIVISION)	
R744			RK73GB2A103J	CHIP R 10K J 1/10W	J3	IC522,523			AK4518	MICROCONTROLLER IC	
R745-747			RK73FB2B000J	CHIP R 0.0 J 1/8W		IC524-529			NJM2100V-ZB	IC (CODEC 16BIT)	
R748			RK73GB2A104J	CHIP R 100K J 1/10W		IC530			BU2099FV	IC (SERIAL/PARALLEL)	
R749			RD14BB2C473J	RD 47K J 1/6W		IC531-534			BU4066BCFV	IC (ANALOG SWITCH)	
D5			RLS245	DIODE		IC535			NJM2100V-ZB	IC (BUFFER FOR ANALOG SIGNAL INPUT/OUTPUT)	
D6		*	MA2J729	DIODE		Q1			DTC143EUA	DIGITAL TRANSISTOR	
D11			DAN202U	DIODE		Q2			DTA143EUA	DIGITAL TRANSISTOR	
D12			MA2S111-F	DIODE	E1,E2,E3	Q3			DTC143EUA	DIGITAL TRANSISTOR	
D12			MA2S111-F	DIODE	E4,E5	Q4			DTA143EUA	DIGITAL TRANSISTOR	

J : TS-2000S J1 : TS-2000V J2 : TS-2000SX J3 : TS-2000VX

K1 : TS-2000 (K) K2 : TS-B2000 (K) K3 : TS-2000X (K)

E1 : TS-2000 (E) E2 : TS-B2000 (E) E3 : TS-2000 (E2) E4 : TS-B2000 (E2) E5 : TS-2000X (E)

PARTS LIST

DISPLAY UNIT (X54-3320-00)
TX-RX 1 UNIT (X57-605X-XX)

Ref. No.	Address	New parts	Parts No.	Description	Desti-nation	Ref. No.	Address	New parts	Parts No.	Description	Desti-nation
R32			RK73FB2B221J	CHIP R 220 J 1/8W	E3,E5,J	D802			B30-2139-05	LED (G)	E3,E5,J
R32			RK73FB2B221J	CHIP R 220 J 1/8W	J1,J2,J3	D802			B30-2139-05	LED (G)	J1,J2,J3
R32			RK73FB2B221J	CHIP R 220 J 1/8W	K1,K3,E1	D802			B30-2139-05	LED (G)	K1,K3,E1
R35			RK73FB2B222J	CHIP R 2.2K J 1/8W	E3,E5,J	D803			B30-2138-05	LED (SR)	E3,E5,J
R35			RK73FB2B222J	CHIP R 2.2K J 1/8W	J1,J2,J3	D803			B30-2138-05	LED (SR)	J1,J2,J3
R35			RK73FB2B222J	CHIP R 2.2K J 1/8W	K1,K3,E1	D803			B30-2138-05	LED (SR)	K1,K3,E1
R36			RK73FB2B102J	CHIP R 1.0K J 1/8W	E3,E5,J	D804			B30-2139-05	LED (G)	E3,E5,J
R36			RK73FB2B102J	CHIP R 1.0K J 1/8W	J1,J2,J3	D804			B30-2139-05	LED (G)	J1,J2,J3
R36			RK73FB2B102J	CHIP R 1.0K J 1/8W	K1,K3,E1	D804			B30-2139-05	LED (G)	K1,K3,E1
R37			RK73FB2B392J	CHIP R 3.9K J 1/8W	E3,E5,J	D810-824			B30-2167-05	LED (GR)	E3,E5,J
R37			RK73FB2B392J	CHIP R 3.9K J 1/8W	J1,J2,J3	D810-824			B30-2167-05	LED (GR)	J1,J2,J3
R37			RK73FB2B392J	CHIP R 3.9K J 1/8W	K1,K3,E1	D810-824			B30-2167-05	LED (GR)	K1,K3,E1
R38			RK73FB2B682J	CHIP R 6.8K J 1/8W	E3,E5,J	D825			B30-2146-05	LED (OR)	E3,E5,J
R38			RK73FB2B682J	CHIP R 6.8K J 1/8W	J1,J2,J3	D825			B30-2146-05	LED (OR)	J1,J2,J3
R38			RK73FB2B682J	CHIP R 6.8K J 1/8W	K1,K3,E1	D825			B30-2146-05	LED (OR)	K1,K3,E1
R39			RK73FB2B152J	CHIP R 1.5K J 1/8W	E3,E5,J	D826-834			B30-2167-05	LED (GR)	E3,E5,J
R39			RK73FB2B152J	CHIP R 1.5K J 1/8W	J1,J2,J3	D826-834			B30-2167-05	LED (GR)	J1,J2,J3
R39			RK73FB2B152J	CHIP R 1.5K J 1/8W	K1,K3,E1	D826-834			B30-2167-05	LED (GR)	K1,K3,E1
R40			RK73FB2B272J	CHIP R 2.7K J 1/8W	E3,E5,J	D953,954			B30-2217-05	LED (Y)	E3,E5,J
R40			RK73FB2B272J	CHIP R 2.7K J 1/8W	J1,J2,J3	D953,954			B30-2217-05	LED (Y)	J1,J2,J3
R40			RK73FB2B272J	CHIP R 2.7K J 1/8W	K1,K3,E1	D953,954			B30-2217-05	LED (Y)	K1,K3,E1
R41-43			RK73RB2H5R6J	CHIP R 5.6 J 1/2W	E3,E5,J	D955			B30-2167-05	LED (GR)	E3,E5,J
R41-43			RK73RB2H5R6J	CHIP R 5.6 J 1/2W	J1,J2,J3	D955			B30-2167-05	LED (GR)	J1,J2,J3
R41-43			RK73RB2H5R6J	CHIP R 5.6 J 1/2W	K1,K3,E1	D955			B30-2167-05	LED (GR)	K1,K3,E1
VR1			R32-0676-05	SEMI FIXED VARIABLE RESISTOR	E3,E5,J	D956			B30-2218-05	LED (OR)	E3,E5,J
VR1			R32-0676-05	SEMI FIXED VARIABLE RESISTOR	J1,J2,J3	D956			B30-2218-05	LED (OR)	J1,J2,J3
VR1			R32-0676-05	SEMI FIXED VARIABLE RESISTOR	K1,K3,E1	D956			B30-2218-05	LED (OR)	K1,K3,E1
S1-12			S70-0475-15	TACT SWITCH	E3,E5,J	D957			B30-2140-05	LED (Y)	E3,E5,J
S1-12			S70-0475-15	TACT SWITCH	J1,J2,J3	D957			B30-2140-05	LED (Y)	J1,J2,J3
S1-12			S70-0475-15	TACT SWITCH	K1,K3,E1	D957			B30-2140-05	LED (Y)	K1,K3,E1
IC1,2		*	NJU6433FG1-ZB	IC (LCD DRIVER)	E3,E5,J	D958			B30-2168-05	LED (RED)	K2,E2,E4
IC1,2		*	NJU6433FG1-ZB	IC (LCD DRIVER)	J1,J2,J3	C1,2			CK73GB1H103K	CHIP C 0.010UF	K
IC1,2		*	NJU6433FG1-ZB	IC (LCD DRIVER)	K1,K3,E1	C3			CC73GCH1H470J	CHIP C 47PF	J
IC3			SED1526FOA	IC (LCD DRIVER)	E3,E5,J	C4			CC73GCH1H070D	CHIP C 7.0PF	D
IC3			SED1526FOA	IC (LCD DRIVER)	J1,J2,J3	C5			CC73GCH1H470J	CHIP C 47PF	J
IC3			SED1526FOA	IC (LCD DRIVER)	K1,K3,E1	C6			CK73EB1H104K	CHIP C 0.10UF	K
IC4			BU2099FV	IC (SERIAL/PARALLEL)	E3,E5,J	C7,8			CK73GB1H103K	CHIP C 0.010UF	K
IC4			BU2099FV	IC (SERIAL/PARALLEL)	J1,J2,J3	C9			CK73GB1H222K	CHIP C 2200PF	K
IC4			BU2099FV	IC (SERIAL/PARALLEL)	K1,K3,E1	C10			CK73FB1E104K	CHIP C 0.10UF	K
Q1			2SA1641(S,T)	TRANSISTOR	E3,E5,J	C11			CK73FB1C105K	CHIP C 1.0UF	K
Q1			2SA1641(S,T)	TRANSISTOR	J1,J2,J3	C12	*		CD04AZ1H4R7M	ELECTRO 4.7UF	50WV
Q1			2SA1641(S,T)	TRANSISTOR	K1,K3,E1	C13			CK73FB1E104K	CHIP C 0.10UF	K
Q2		*	2SC2712-F(Y)	TRANSISTOR	E3,E5,J	C14			CK73GB1H103K	CHIP C 0.010UF	K
Q2		*	2SC2712-F(Y)	TRANSISTOR	J1,J2,J3	C15			CK73GB1H472K	CHIP C 4700PF	K
Q2		*	2SC2712-F(Y)	TRANSISTOR	K1,K3,E1	C16			CK73GB1H222K	CHIP C 2200PF	K
Q3			2SA1162-F(Y)	TRANSISTOR	E3,E5,J	C17			CK73FB1E104K	CHIP C 0.10UF	K
Q3			2SA1162-F(Y)	TRANSISTOR	J1,J2,J3	C18			CK73GB1H103K	CHIP C 0.010UF	K
Q3			2SA1162-F(Y)	TRANSISTOR	K1,K3,E1	C19			CK73FB1C105K	CHIP C 1.0UF	K
TX-RX 1 UNIT (X57-605X-XX) 0-00 : J,J2 0-01 : J1,J3 0-11 : K1,K3 0-12 : K2 2-71 : E1,E3,E5 2-72 : E2,E4						C20			CK73FB1E104K	CHIP C 0.10UF	K
						C21			CK73GB1H152K	CHIP C 1500PF	K
						C22			CK73GB1H472K	CHIP C 4700PF	K
						C23			CK73GB1H152K	CHIP C 1500PF	K
						C24,25			CK73GB1H103K	CHIP C 0.010UF	K
						C26			CK73GB1H392K	CHIP C 3900PF	K
						C27			CK73FB1E104K	CHIP C 0.10UF	K
						C28-30			CK73GB1H102K	CHIP C 1000PF	K
						C31			CK73GB1H332K	CHIP C 3300PF	K
						C32			CK73FB1E104K	CHIP C 0.10UF	K
C33			CK73GB1H222K	CHIP C 2200PF	K						
D86			B30-2001-05	LED (RED)							
D105			B30-2001-05	LED (RED)							
D801			B30-2138-05	LED (SR)	E3,E5,J						
D801			B30-2138-05	LED (SR)	J1,J2,J3						
D801			B30-2138-05	LED (SR)	K1,K3,E1						

PARTS LIST

TX-RX 1 UNIT (X57-605X-XX)

Ref. No.	Address	New parts	Parts No.	Description	Destination	Ref. No.	Address	New parts	Parts No.	Description	Destination
C34			CK73FB1E104K	CHIP C 0.10UF K		C102			CK73FB1E104K	CHIP C 0.10UF K	
C35			CK73GB1H102K	CHIP C 1000PF K		C103			CC73GCH1H820J	CHIP C 82PF J	
C36			CK73GB1H561K	CHIP C 560PF K		C104			CK73GB1H102K	CHIP C 1000PF K	
C37			CK73GB1H102K	CHIP C 1000PF K		C105			CC73GCH1H390J	CHIP C 39PF J	
C38			CK73GB1H222K	CHIP C 2200PF K		C106			CC73GCH1H330J	CHIP C 33PF J	
C39			CK73FB1E104K	CHIP C 0.10UF K		C107			CK73GB1H103K	CHIP C 0.010UF K	
C40			CK73GB1H102K	CHIP C 1000PF K		C108-111			CK73FB1E104K	CHIP C 0.10UF K	
C41			CK73FB1E104K	CHIP C 0.10UF K		C112			CK73GB1H471K	CHIP C 470PF K	
C42			CK73GB1H102K	CHIP C 1000PF K		C113			CC73GCH1H010B	CHIP C 1.0PF B	
C43			CC73GCH1H271J	CHIP C 270PF J		C114			CK73GB1H103K	CHIP C 0.010UF K	
C44,45			CK73GB1H102K	CHIP C 1000PF K		C115			CK73GB1C104K	CHIP C 0.10UF K	
C46,47			CK73FB1E104K	CHIP C 0.10UF K		C116			CC73GCH1H180J	CHIP C 18PF J	
C48			CK73GB1H102K	CHIP C 1000PF K		C117			CK73GB1H103K	CHIP C 0.010UF K	
C49,50			CC73GCH1H100D	CHIP C 10PF D		C118			CC73GCH1H020B	CHIP C 2.0PF B	
C51			CK73GB1H102K	CHIP C 1000PF K		C119			CK73GB1H103K	CHIP C 0.010UF K	
C52			CK73FB1E104K	CHIP C 0.10UF K		C121			CK73FB1C105K	CHIP C 1.0UF K	
C53			CK73GB1H102K	CHIP C 1000PF K		C123			CK73GB1C104K	CHIP C 0.10UF K	
C54			CK73FB1E104K	CHIP C 0.10UF K		C124			CK73GB1H103K	CHIP C 0.010UF K	
C55			CK73GB1H102K	CHIP C 1000PF K		C125,126			CK73GB1C104K	CHIP C 0.10UF K	
C56			CC73GCH1H121J	CHIP C 120PF J		C127			CK73FB1C105K	CHIP C 1.0UF K	
C57,58			CK73GB1H102K	CHIP C 1000PF K		C129,130			CK73GB1H103K	CHIP C 0.010UF K	
C59			CK73FB1E104K	CHIP C 0.10UF K		C131			CC73GCH1H270J	CHIP C 27PF J	
C60			CK73GB1H102K	CHIP C 1000PF K		C132			CK73GB1H103K	CHIP C 0.010UF K	
C61			CK73FB1E104K	CHIP C 0.10UF K		C133			CK73GB1H471K	CHIP C 470PF K	
C62			CK73GB1H102K	CHIP C 1000PF K		C134			CK73FB1E104K	CHIP C 0.10UF K	
C63			CC73GCH1H820J	CHIP C 82PF J		C135,136			CK73GB1H103K	CHIP C 0.010UF K	
C64,65			CK73GB1H102K	CHIP C 1000PF K		C137			CK73GB1H471K	CHIP C 470PF K	
C66,67			CK73FB1E104K	CHIP C 0.10UF K		C138,139			CK73GB1H103K	CHIP C 0.010UF K	
C68			CK73GB1H102K	CHIP C 1000PF K		C140			CC73GCH1H060D	CHIP C 6.0PF D	
C69,70			CC73GCH1H040C	CHIP C 4.0PF C		C141			CC73GCH1H020B	CHIP C 2.0PF B	
C71			CK73GB1H102K	CHIP C 1000PF K		C143,144			CK73GB1H103K	CHIP C 0.010UF K	
C72			CK73FB1E104K	CHIP C 0.10UF K		C145			CC73GCH1H030C	CHIP C 3.0PF C	
C73			CK73GB1H391K	CHIP C 390PF K		C146,147			CC73GCH1H020B	CHIP C 2.0PF B	
C74			CK73FB1E104K	CHIP C 0.10UF K		C148			CK73GB1H103K	CHIP C 0.010UF K	
C75			CK73GB1H102K	CHIP C 1000PF K		C149			CC73GCH1H101J	CHIP C 100PF J	
C76			CC73GCH1H560J	CHIP C 56PF J		C150			CK73GB1H102K	CHIP C 1000PF K	
C77			CK73GB1H102K	CHIP C 1000PF K		C151			CC73GCH1H010B	CHIP C 1.0PF B	
C78			CK73GB1H471K	CHIP C 470PF K		C152-154			CK73GB1H103K	CHIP C 0.010UF K	
C79			CK73FB1E104K	CHIP C 0.10UF K		C156			CK73GB1H103K	CHIP C 0.010UF K	
C80			CC73GCH1H151J	CHIP C 150PF J		C158-164			CK73GB1H103K	CHIP C 0.010UF K	
C81			CK73FB1E104K	CHIP C 0.10UF K		C165			CC73GCH1H020B	CHIP C 2.0PF B	
C82			CK73GB1H102K	CHIP C 1000PF K		C166			CK73GB1H103K	CHIP C 0.010UF K	
C83			CC73GCH1H390J	CHIP C 39PF J		C167			CC73GCH1H100D	CHIP C 10PF D	
C84			CK73GB1H102K	CHIP C 1000PF K		C168,169			CK73GB1H103K	CHIP C 0.010UF K	
C85			CC73GCH1H181J	CHIP C 180PF J		C172-177			CK73GB1H103K	CHIP C 0.010UF K	
C86			CK73FB1E104K	CHIP C 0.10UF K		C178			CC73GCH1H100D	CHIP C 10PF D	
C87			CC73GCH1H220J	CHIP C 22PF J		C179			CC73GCH1H060D	CHIP C 6.0PF D	
C88			CK73FB1E104K	CHIP C 0.10UF K		C180			CK73GB1H103K	CHIP C 0.010UF K	
C89			CK73GB1H102K	CHIP C 1000PF K		C181			CC73GCH1H100D	CHIP C 10PF D	
C90			CC73GCH1H470J	CHIP C 47PF J		C182,183			CK73GB1H103K	CHIP C 0.010UF K	
C91			CK73GB1H102K	CHIP C 1000PF K		C184			CC73GCH1H120J	CHIP C 12PF J	
C93			CK73FB1E104K	CHIP C 0.10UF K		C185,186			CK73GB1H103K	CHIP C 0.010UF K	
C94			CC73GCH1H120J	CHIP C 12PF J		C187			CC73GCH1H120J	CHIP C 12PF J	
C95			CK73FB1E104K	CHIP C 0.10UF K		C190			CC73GCH1H080D	CHIP C 8.0PF D	
C96			CK73GB1H102K	CHIP C 1000PF K		C191			CC73GCH1H200J	CHIP C 20PF J	
C97			CC73GCH1H330J	CHIP C 33PF J		C192			CK73GB1H103K	CHIP C 0.010UF K	
C98			CK73GB1H102K	CHIP C 1000PF K		C193			CC73GCH1H080D	CHIP C 8.0PF D	
C99			CK73FB1E104K	CHIP C 0.10UF K		C196			CK73GB1H103K	CHIP C 0.010UF K	
C100			CC73GCH1H560J	CHIP C 56PF J		C197		*	CD04AZ1H100M	ELECTRO 10UF 50WV	
C101			CC73GCH1H150J	CHIP C 15PF J		C198-201			CK73GB1H103K	CHIP C 0.010UF K	

PARTS LIST

TX-RX 1 UNIT (X57-605X-XX)

Ref. No.	Address	New parts	Parts No.	Description	Desti-nation	Ref. No.	Address	New parts	Parts No.	Description	Desti-nation
C202			CC73GCH1H100D	CHIP C 10PF D		C309			CK73GB1H103K	CHIP C 0.010UF K	
C203			CC73GCH1H040C	CHIP C 4.0PF C		C310		*	CC73GUJ1H180J	CHIP C 18PF J	
C204			CS77AA1A100M	CHIP TNL 10UF 10WV		C311			CC73GCH1H0R5B	CHIP C 0.5PF B	
C205			CC73GCH1H100D	CHIP C 10PF D		C312			CK73GB1C104K	CHIP C 0.10UF K	
C206-211			CK73GB1H103K	CHIP C 0.010UF K		C313		*	CC73GUJ1H180J	CHIP C 18PF J	
C213,214			CK73GB1H103K	CHIP C 0.010UF K		C314			CC73GCH1H020B	CHIP C 2.0PF B	
C216			CS77CA1ER47M	CHIP TNL 0.47UF 25WV		C315			CK73GB1H103K	CHIP C 0.010UF K	
C217,218			CK73GB1H103K	CHIP C 0.010UF K		C316		*	CC73GUJ1H270J	CHIP C 27PF J	
C219			CS77CA1ER47M	CHIP TNL 0.47UF 25WV		C317-320			CK73GB1H103K	CHIP C 0.010UF K	
C221,222			CK73GB1H103K	CHIP C 0.010UF K		C321			CC73GUJ1H150J	CHIP C 15PF J	
C223			CK73GB1H102K	CHIP C 1000PF K		C322,323			CK73GB1H103K	CHIP C 0.010UF K	
C224			CC73GCH1H100D	CHIP C 10PF D		C324			CK73GB1H332K	CHIP C 3300PF K	
C225			CK73GB1H103K	CHIP C 0.010UF K		C327-337			CK73GB1H103K	CHIP C 0.010UF K	
C227,228			CK73GB1H103K	CHIP C 0.010UF K		C338			CK73FB1C105K	CHIP C 1.0UF K	
C229			CS77CA1C010M	CHIP TNL 1.0UF 16WV		C339-342			CK73GB1H103K	CHIP C 0.010UF K	
C230		*	CD04AZ1V101M	ELECTRO 100UF 35WV		C343			CK73GB1C104K	CHIP C 0.10UF K	
C233			CC73GCH1H270J	CHIP C 27PF J		C344-346			CK73GB1H103K	CHIP C 0.010UF K	
C234,235			CK73GB1H103K	CHIP C 0.010UF K		C347			CK73FB1C474K	CHIP C 0.47UF K	
C236			CK73GB1H102K	CHIP C 1000PF K		C348			CK73GB1H471K	CHIP C 470PF K	
C237,238			CK73GB1C104K	CHIP C 0.10UF K		C349			CK73GB1C273K	CHIP C 0.027UF K	
C239			CC73GCH1H221J	CHIP C 220PF J		C350			CK73GB1H103K	CHIP C 0.010UF K	
C241			CK73GB1C104K	CHIP C 0.10UF K		C351			CK73FB1E104K	CHIP C 0.10UF K	
C242			CK73GB1H472K	CHIP C 4700PF K		C352			CK73GB1C473K	CHIP C 0.047UF K	
C243			CK73GB1C104K	CHIP C 0.10UF K		C353-358			CK73GB1H103K	CHIP C 0.010UF K	
C244			CK73FB1C105K	CHIP C 1.0UF K		C359			CC73GCH1H010B	CHIP C 1.0PF B	
C245			CK73GB1C104K	CHIP C 0.10UF K		C361-363			CK73GB1H103K	CHIP C 0.010UF K	
C246-250			CK73FB1C105K	CHIP C 1.0UF K		C364		*	CD04AZ1H100M	ELECTRO 10UF 50WV	
C251			CK73GB1C104K	CHIP C 0.10UF K		C365-369			CK73GB1H103K	CHIP C 0.010UF K	
C252			CK73GB1C473K	CHIP C 0.047UF K		C370			CC73GCH1H100D	CHIP C 10PF D	
C254			CK73GB1E223K	CHIP C 0.022UF K		C373			CS77AA1A4R7M	CHIP TNL 4.7UF 10WV	
C258		*	CD04AZ1H100M	ELECTRO 10UF 50WV		C374			CK73FB1C105K	CHIP C 1.0UF K	
C259-262			CK73GB1C104K	CHIP C 0.10UF K		C375-378			CK73GB1H103K	CHIP C 0.010UF K	
C263			CK73GB1H103K	CHIP C 0.010UF K		C379			CC73GCH1H030C	CHIP C 3.0PF C	
C264-269			CK73GB1C104K	CHIP C 0.10UF K		C380			CK73GB1H103K	CHIP C 0.010UF K	
C270			CC73GCH1H101J	CHIP C 100PF J		C381,382			CC73GCH1H221J	CHIP C 220PF J	
C271			CK73GB1C104K	CHIP C 0.10UF K		C383			CC73GUJ1H070D	CHIP C 7.0PF D	
C272			CC73GCH1H331J	CHIP C 330PF J		C384			CC73GUJ1H030C	CHIP C 3.0PF C	
C273,274			CK73GB1C104K	CHIP C 0.10UF K		C385			CK73FB1C105K	CHIP C 1.0UF K	
C275			CC73GCH1H271J	CHIP C 270PF J		C386			CK73GB1H103K	CHIP C 0.010UF K	
C276-278			CK73GB1C104K	CHIP C 0.10UF K		C388			CS77AA1A100M	CHIP TNL 10UF 10WV	
C279			CK73GB1H103K	CHIP C 0.010UF K		C389			CK73GB1E223K	CHIP C 0.022UF K	
C281			CK73FB1C105K	CHIP C 1.0UF K		C390,391			CK73FB1C105K	CHIP C 1.0UF K	
C282			CC73GCH1H101J	CHIP C 100PF J		C393			CK73FB1C105K	CHIP C 1.0UF K	
C283		*	CD04AZ1H100M	ELECTRO 10UF 50WV		C394			CS77AA1A4R7M	CHIP TNL 4.7UF 10WV	
C284			CK73GB1H103K	CHIP C 0.010UF K		C395			CK73GB1H103K	CHIP C 0.010UF K	
C286			CK73FB1C105K	CHIP C 1.0UF K		C396		*	CD04AZ1V101M	ELECTRO 100UF 35WV	
C287,288			CK73GB1C104K	CHIP C 0.10UF K		C397,398		*	CD04AY1E470M	ELECTRO 47UF 25WV	
C289			CK73GB1H103K	CHIP C 0.010UF K		C399		*	CD04AZ1E471M	ELECTRO 470UF 25WV	
C290			CK73GB1C104K	CHIP C 0.10UF K		C400			CD04AR1C331M	ELECTRO 330UF 16WV	
C291			CK73FB1E104K	CHIP C 0.10UF K		C401		*	CD04AZ1E471M	ELECTRO 470UF 25WV	
C292			CC73GCH1H390J	CHIP C 39PF J		C402			CK73FB1E104K	CHIP C 0.10UF K	
C293,294			CK73GB1H103K	CHIP C 0.010UF K		C403		*	CD04AY1E470M	ELECTRO 47UF 25WV	
C295-298			CK73GB1C104K	CHIP C 0.10UF K		C404			CK73FB1E104K	CHIP C 0.10UF K	
C299-301			CK73GB1H103K	CHIP C 0.010UF K		C405		*	CD04AY1E470M	ELECTRO 47UF 25WV	
C302			CC73GUJ1H150J	CHIP C 15PF J		C406			CK73GB1H103K	CHIP C 0.010UF K	
C303			CK73GB1H471K	CHIP C 470PF K		C407,408		*	CD04AZ1H100M	ELECTRO 10UF 50WV	
C304			CK73GB1H103K	CHIP C 0.010UF K		C409			CK73FB1C105K	CHIP C 1.0UF K	
C305			CK73GB1H471K	CHIP C 470PF K		C410-413			CK73FB1E104K	CHIP C 0.10UF K	
C306,307			CK73GB1H103K	CHIP C 0.010UF K		C417			CK73GB1H102K	CHIP C 1000PF K	
C308			CC73GCH1H010B	CHIP C 1.0PF B		C418			CK73GB1H471K	CHIP C 470PF K	

J : TS-2000S J1 : TS-2000V J2 : TS-2000SX J3 : TS-2000VX

K1 : TS-2000 (K) K2 : TS-B2000 (K) K3 : TS-2000X (K)

E1 : TS-2000 (E) E2 : TS-B2000 (E) E3 : TS-2000 (E2) E4 : TS-B2000 (E2) E5 : TS-2000X (E)

PARTS LIST

TX-RX 1 UNIT (X57-605X-XX)

Ref. No.	Address	New parts	Parts No.	Description	Destination	Ref. No.	Address	New parts	Parts No.	Description	Destination
C419			CK73GB1H102K	CHIP C 1000PF K		C522		*	CD04AZ1V101M	ELECTRO 100UF 35WV	
C420			CS77CA1C010M	CHIP TNTL 1.0UF 16WV		C523-525			CS77AA1A4R7M	CHIP TNTL 4.7UF 10WV	
C421			CK73GB1H102K	CHIP C 1000PF K		C526-528			CK73FB1C105K	CHIP C 1.0UF K	
C422,423			CK73GB1H471K	CHIP C 470PF K		C529-531			CS77AA1A4R7M	CHIP TNTL 4.7UF 10WV	
C424			CK73GB1H102K	CHIP C 1000PF K		C532-537			CK73GB1H102K	CHIP C 1000PF K	
C425			CK73FB1E104K	CHIP C 0.10UF K		C538,539			CK73GB1H103K	CHIP C 0.010UF K	
C426			CK73GB1H222K	CHIP C 2200PF K		C547			CK73GB1H103K	CHIP C 0.010UF K	
C427			CK73GB1H332K	CHIP C 3300PF K		C553		*	CD04AZ1E221M	ELECTRO 220UF 25WV	
C428		*	CD04AY1E470M	ELECTRO 47UF 25WV		C556			CK73FB1C105K	CHIP C 1.0UF K	
C429			CK73GB1H103K	CHIP C 0.010UF K		C601			CK73GB1C473K	CHIP C 0.047UF K	
C430,431		*	CD04AY1E470M	ELECTRO 47UF 25WV		C602		*	CD04AZ1H100M	ELECTRO 10UF 50WV	
C432,433			CK73GB1H103K	CHIP C 0.010UF K		C603			CK73GB1C473K	CHIP C 0.047UF K	
C434-436			CK73GB1H102K	CHIP C 1000PF K		C604			CK73GB1H472K	CHIP C 4700PF K	
C437			CK73GB1H103K	CHIP C 0.010UF K		C605-607			CK73GB1H103K	CHIP C 0.010UF K	
C438			CK45FE2H222PN	CERAMIC 2200PF P		C608		*	CD04AZ1H100M	ELECTRO 10UF 50WV	
C439,440			CK73GB1H103K	CHIP C 0.010UF K		C609			CK73GB1H472K	CHIP C 4700PF K	
C441-444			CK73GB1H102K	CHIP C 1000PF K		C610-613			CK73GB1C473K	CHIP C 0.047UF K	
C449-452			CK73FB1C105K	CHIP C 1.0UF K		C614			CK73GB1H102K	CHIP C 1000PF K	
C453			CK73GB1H103K	CHIP C 0.010UF K		C615			CK73GB1H182K	CHIP C 1800PF K	
C454			CK73FB1C105K	CHIP C 1.0UF K		C616			CK73GB1H102K	CHIP C 1000PF K	
C455			CK73GB1H102K	CHIP C 1000PF K		C617		*	CD04AZ1H100M	ELECTRO 10UF 50WV	
C456		*	CD04AZ1V101M	ELECTRO 100UF 35WV		C618,619			CK73GB1C473K	CHIP C 0.047UF K	
C457			CK73GB1H102K	CHIP C 1000PF K		C620			CK73GB1H472K	CHIP C 4700PF K	
C458			CK73FB1C105K	CHIP C 1.0UF K		C621-623			CK73GB1H103K	CHIP C 0.010UF K	
C459			CK73GB1H103K	CHIP C 0.010UF K		C624		*	CD04AZ1H100M	ELECTRO 10UF 50WV	
C460,461			CK73GB1H102K	CHIP C 1000PF K		C625,626			CK73GB1C473K	CHIP C 0.047UF K	
C462			CK73GB1H103K	CHIP C 0.010UF K		C627			CK73GB1H472K	CHIP C 4700PF K	
C463-466			CK73GB1H102K	CHIP C 1000PF K		C628,629			CK73GB1C473K	CHIP C 0.047UF K	
C467-470			CK73GB1H103K	CHIP C 0.010UF K		C630			CC73GCH1H680J	CHIP C 68PF J	
C471			CK73GB1E223K	CHIP C 0.022UF K		C631			CC73GCH1H180J	CHIP C 18PF J	
C472			CS77CA1ER47M	CHIP TNTL 0.47UF 25WV		C632			CC73GCH1H820J	CHIP C 82PF J	
C473			CK73GB1C473K	CHIP C 0.047UF K		C633			CC73GCH1H080D	CHIP C 8.0PF D	
C474			CK73GB1H102K	CHIP C 1000PF K		C634			CC73GCH1H390J	CHIP C 39PF J	
C475			CK73GB1H103K	CHIP C 0.010UF K		C635		*	CD04AZ1H100M	ELECTRO 10UF 50WV	
C476		*	CD04AZ1H100M	ELECTRO 10UF 50WV		C636,637			CK73GB1C473K	CHIP C 0.047UF K	
C477		*	CD04AZ1H4R7M	ELECTRO 4.7UF 50WV		C638			CK73GB1H472K	CHIP C 4700PF K	
C478			CK73GB1H103K	CHIP C 0.010UF K		C639-641			CK73GB1H103K	CHIP C 0.010UF K	
C479			CC73GCH1H101J	CHIP C 100PF J		C642		*	CD04AZ1H100M	ELECTRO 10UF 50WV	
C480		*	CD04AZ1H4R7M	ELECTRO 4.7UF 50WV		C643			CK73GB1H472K	CHIP C 4700PF K	
C481-484			CK73GB1H102K	CHIP C 1000PF K		C644-647			CK73GB1C473K	CHIP C 0.047UF K	
C485-487			CC73GCH1H101J	CHIP C 100PF J		C648			CC73GCH1H390J	CHIP C 39PF J	
C488		*	CD04AZ1H100M	ELECTRO 10UF 50WV		C649			CC73GCH1H180J	CHIP C 18PF J	
C489			CK73GB1H103K	CHIP C 0.010UF K		C650			CC73GCH1H820J	CHIP C 82PF J	
C490,491			CC73GCH1H101J	CHIP C 100PF J		C651			CC73GCH1H090B	CHIP C 9.0PF B	
C492			CS77CA1C010M	CHIP TNTL 1.0UF 16WV		C652			CC73GCH1H390J	CHIP C 39PF J	
C493-499			CK73GB1H103K	CHIP C 0.010UF K		C700		*	CD04AZ1H220M	ELECTRO 22UF 50WV	
C500			CK73GB1C104K	CHIP C 0.10UF K		C703			CK73GB1H103K	CHIP C 0.010UF K	
C501			CK73GB1H103K	CHIP C 0.010UF K		C704			CK73GB1C104K	CHIP C 0.10UF K	
C502			CK73GB1C104K	CHIP C 0.10UF K		C705			CC73GCH1H221J	CHIP C 220PF J	
C505			CK73GB1H102K	CHIP C 1000PF K		C706-708			CC73GUJ1H040C	CHIP C 4.0PF C	
C506		*	CD04AZ1H220M	ELECTRO 22UF 50WV		C709,710			CK73GB1H103K	CHIP C 0.010UF K	
C507,508			CK73GB1H102K	CHIP C 1000PF K		C711			CK73GB1H102K	CHIP C 1000PF K	
C509		*	CD04AZ1H220M	ELECTRO 22UF 50WV		C712-716			CK73GB1H103K	CHIP C 0.010UF K	
C510,511			CK73GB1H102K	CHIP C 1000PF K		C718			CC73GUJ1H040C	CHIP C 4.0PF C	
C512		*	CD04AZ1H220M	ELECTRO 22UF 50WV		C719			CK73GB1H103K	CHIP C 0.010UF K	
C513,514			CK73GB1H102K	CHIP C 1000PF K		C720			CC73GCH1H390J	CHIP C 39PF J	
C515		*	CD04AZ1H220M	ELECTRO 22UF 50WV		C721,722			CK73GB1C104K	CHIP C 0.10UF K	
C516			CK73GB1H102K	CHIP C 1000PF K		C723			CS77AA1A4R7M	CHIP TNTL 4.7UF 10WV	
C517-520			CK73FB1E104K	CHIP C 0.10UF K		C724,725			CK73GB1H103K	CHIP C 0.010UF K	
C521			CK73GB1H102K	CHIP C 1000PF K		C726			CK73FB1C105K	CHIP C 1.0UF K	

PARTS LIST

TX-RX 1 UNIT (X57-605X-XX)

Ref. No.	Address	New parts	Parts No.	Description	Desti-nation	Ref. No.	Address	New parts	Parts No.	Description	Desti-nation
C727,728			CC73GCH1H101J	CHIP C 100PF J		C818-820			CK73GB1C104K	CHIP C 0.10UF K	J1,J2,J3
C739			CK73GB1H103K	CHIP C 0.010UF K		C818-820			CK73GB1C104K	CHIP C 0.10UF K	K1,K3,E1
C741			CK73FB1C105K	CHIP C 1.0UF K		C821,822			CC73GCH1H100D	CHIP C 10PF D	E3,E5,J
C743			CK73GB1C104K	CHIP C 0.10UF K		C821,822			CC73GCH1H100D	CHIP C 10PF D	J1,J2,J3
C744			CK73GB1H103K	CHIP C 0.010UF K		C821,822			CC73GCH1H100D	CHIP C 10PF D	K1,K3,E1
C745,746			CK73GB1C104K	CHIP C 0.10UF K		C823			CK73GB1C104K	CHIP C 0.10UF K	E3,E5,J
C747			CK73FB1C105K	CHIP C 1.0UF K		C823			CK73GB1C104K	CHIP C 0.10UF K	J1,J2,J3
C749			CK73GB1H103K	CHIP C 0.010UF K		C823			CK73GB1C104K	CHIP C 0.10UF K	K1,K3,E1
C750			CK73FB1E104K	CHIP C 0.10UF K		C824			CK73GB1H103K	CHIP C 0.010UF K	E3,E5,J
C752			CC73GCH1H560J	CHIP C 56PF J		C824			CK73GB1H103K	CHIP C 0.010UF K	J1,J2,J3
C753			CC73GCH1H100D	CHIP C 10PF D		C824			CK73GB1H103K	CHIP C 0.010UF K	K1,K3,E1
C754			CC73GCH1H221J	CHIP C 220PF J		C826-842			CK73GB1H102K	CHIP C 1000PF K	E3,E5,J
C755			CC73GCH1H271J	CHIP C 270PF J		C826-842			CK73GB1H102K	CHIP C 1000PF K	J1,J2,J3
C757			CK73GB1H102K	CHIP C 1000PF K		C826-842			CK73GB1H102K	CHIP C 1000PF K	K1,K3,E1
C758			CK73GB1E223K	CHIP C 0.022UF K		C844			CK73GB1H102K	CHIP C 1000PF K	E3,E5,J
C759,760			CK73FB1C105K	CHIP C 1.0UF K		C844			CK73GB1H102K	CHIP C 1000PF K	J1,J2,J3
C761,762			CK73GB1H103K	CHIP C 0.010UF K		C844			CK73GB1H102K	CHIP C 1000PF K	K1,K3,E1
C763			CC73GCH1H030C	CHIP C 3.0PF C		C847-850			CK73GB1H102K	CHIP C 1000PF K	E3,E5,J
C765,766			CK73GB1H103K	CHIP C 0.010UF K		C847-850			CK73GB1H102K	CHIP C 1000PF K	J1,J2,J3
C767			CC73GCH1H010B	CHIP C 1.0PF B		C847-850			CK73GB1H102K	CHIP C 1000PF K	K1,K3,E1
C770,771			CK73GB1H102K	CHIP C 1000PF K		C851			CK73GB1H103K	CHIP C 0.010UF K	E3,E5,J
C772			CC73GCH1H470J	CHIP C 47PF J		C851			CK73GB1H103K	CHIP C 0.010UF K	J1,J2,J3
C773-776			CK73GB1H102K	CHIP C 1000PF K		C851			CK73GB1H103K	CHIP C 0.010UF K	K1,K3,E1
C777			CC73GCH1H221J	CHIP C 220PF J		C852-855			CK73GB1H102K	CHIP C 1000PF K	E3,E5,J
C778		*	CD04A21H100M	ELECTRO 10UF 50WV		C852-855			CK73GB1H102K	CHIP C 1000PF K	J1,J2,J3
C779			CK73GB1C104K	CHIP C 0.10UF K		C852-855			CK73GB1H102K	CHIP C 1000PF K	K1,K3,E1
C780			CK73GB1H103K	CHIP C 0.010UF K		C858-860			CK73GB1H102K	CHIP C 1000PF K	E3,E5,J
C781			CC73GCH1H101J	CHIP C 100PF J		C858-860			CK73GB1H102K	CHIP C 1000PF K	J1,J2,J3
C782			CS77CA1C010M	CHIP TNL 1.0UF 16WV		C858-860			CK73GB1H102K	CHIP C 1000PF K	K1,K3,E1
C783			CK73GB1C104K	CHIP C 0.10UF K		C861			CK73GB1H103K	CHIP C 0.010UF K	E3,E5,J
C784,785			CK73GB1H152K	CHIP C 1500PF K		C861			CK73GB1H103K	CHIP C 0.010UF K	J1,J2,J3
C786			CK73FB1C334K	CHIP C 0.33UF K		C861			CK73GB1H103K	CHIP C 0.010UF K	K1,K3,E1
C787			CK73FB1E104K	CHIP C 0.10UF K		C862-866			CK73GB1H102K	CHIP C 1000PF K	E3,E5,J
C788,789			CK73FB1C105K	CHIP C 1.0UF K		C862-866			CK73GB1H102K	CHIP C 1000PF K	J1,J2,J3
C790,791			CK73GB1H103K	CHIP C 0.010UF K		C862-866			CK73GB1H102K	CHIP C 1000PF K	K1,K3,E1
C792			CK73EB1H104K	CHIP C 0.10UF K		C867,868			CK73GB1C104K	CHIP C 0.10UF K	E3,E5,J
C793,794			CK73GB1H471K	CHIP C 470PF K		C867,868			CK73GB1C104K	CHIP C 0.10UF K	J1,J2,J3
C795			CK73GB1E105K	CHIP C 1.0UF K		C867,868			CK73GB1C104K	CHIP C 0.10UF K	K1,K3,E1
C800			CK73GB1E223K	CHIP C 0.022UF K	E3,E5,J	C869			CK73FB1C105K	CHIP C 1.0UF K	E3,E5,J
C800			CK73GB1E223K	CHIP C 0.022UF K	J1,J2,J3	C869			CK73FB1C105K	CHIP C 1.0UF K	J1,J2,J3
C800			CK73GB1E223K	CHIP C 0.022UF K	K1,K3,E1	C869			CK73FB1C105K	CHIP C 1.0UF K	K1,K3,E1
C801,802			CK73GB1C104K	CHIP C 0.10UF K	E3,E5,J	C870,871			CK73GB1C473K	CHIP C 0.047UF K	E3,E5,J
C801,802			CK73GB1C104K	CHIP C 0.10UF K	J1,J2,J3	C870,871			CK73GB1C473K	CHIP C 0.047UF K	J1,J2,J3
C801,802			CK73GB1C104K	CHIP C 0.10UF K	K1,K3,E1	C870,871			CK73GB1C473K	CHIP C 0.047UF K	K1,K3,E1
C803		*	C92-0884-05	ELECTRO 22UF 16WV	E3,E5,J	C950,951			CK73GB1H103K	CHIP C 0.010UF K	
C803		*	C92-0884-05	ELECTRO 22UF 16WV	J1,J2,J3	C952-955			CK73EF1C105Z	CHIP C 1.0UF Z	E3,E5,J
C803		*	C92-0884-05	ELECTRO 22UF 16WV	K1,K3,E1	C952-955			CK73EF1C105Z	CHIP C 1.0UF Z	J1,J2,J3
C804			CK73GB1C104K	CHIP C 0.10UF K	E3,E5,J	C952-955			CK73EF1C105Z	CHIP C 1.0UF Z	K1,K3,E1
C804			CK73GB1C104K	CHIP C 0.10UF K	J1,J2,J3	C956-959			CK73GB1H103K	CHIP C 0.010UF K	
C804			CK73GB1C104K	CHIP C 0.10UF K	K1,K3,E1	C962-965			CK73EF1C105Z	CHIP C 1.0UF Z	K2,E2,E4
C806			CK73GB1H102K	CHIP C 1000PF K	E3,E5,J	C966			CK73GB1C104K	CHIP C 0.10UF K	K2,E2,E4
C806			CK73GB1H102K	CHIP C 1000PF K	J1,J2,J3	C967-969			CK73FB1C105K	CHIP C 1.0UF K	K2,E2,E4
C806			CK73GB1H102K	CHIP C 1000PF K	K1,K3,E1	C970		*	CD04AY1A101M	ELECTRO 100UF 10WV	E1,E2,E3
C810,811			CK73GB1C104K	CHIP C 0.10UF K	E3,E5,J	C970		*	CD04AY1A101M	ELECTRO 100UF 10WV	E4,E5
C810,811			CK73GB1C104K	CHIP C 0.10UF K	J1,J2,J3	C970			CE04EW1A101M	ELECTRO 100UF 10WV	J,J1,J2
C810,811			CK73GB1C104K	CHIP C 0.10UF K	K1,K3,E1	C970			CE04EW1A101M	ELECTRO 100UF 10WV	J3
C812-816			CK73GB1H102K	CHIP C 1000PF K	E3,E5,J	C970			CE04EW1A101M	ELECTRO 100UF 10WV	K1,K2,K3
C812-816			CK73GB1H102K	CHIP C 1000PF K	J1,J2,J3	C971			CK73GB1A474K	CHIP C 0.47UF K	E1,E2,E3
C812-816			CK73GB1H102K	CHIP C 1000PF K	K1,K3,E1	C971			CK73GB1A474K	CHIP C 0.47UF K	E4,E5
C818-820			CK73GB1C104K	CHIP C 0.10UF K	E3,E5,J	C972			CK73FB1C105K	CHIP C 1.0UF K	K2,E2,E4

J : TS-2000S J1 : TS-2000V J2 : TS-2000SX J3 : TS-2000VX
 K1 : TS-2000 (K) K2 : TS-B2000 (K) K3 : TS-2000X (K)
 E1 : TS-2000 (E) E2 : TS-B2000 (E) E3 : TS-2000 (E2) E4 : TS-B2000 (E2) E5 : TS-2000X (E)

PARTS LIST

TX-RX 1 UNIT (X57-605X-XX)

Ref. No.	Address	New parts	Parts No.	Description	Destination	Ref. No.	Address	New parts	Parts No.	Description	Destination
TC1,2		*	C05-0344-15	CERAMIC TRIMMER CAPACITOR (30P)	E1,E2,E3	CN959,960			E41-1682-05	PIN ASSY	K2,E2,E4
TC1,2		*	C05-0344-15	CERAMIC TRIMMER CAPACITOR (30P)	E4,E5	CN961		*	E41-1686-05	PIN ASSY	K2,E2,E4
TC3			C05-0369-05	CERAMIC TRIMMER CAPACITOR		CN962		*	E41-1684-05	PIN ASSY	E3,E5,J
-			E18-0254-05	SOCKET		CN962		*	E41-1684-05	PIN ASSY	J1,J2,J3
-			E23-1176-04	EARTH LUG		CN962		*	E41-1684-05	PIN ASSY	K1,K3,E1
-			E37-0895-05	LEAD WIRE WITH TERMINAL	K2,E2,E4	J1			E13-0166-05	PIN JACK	
CN1			E04-0154-05	PIN SOCKET		J2,3			E11-0414-05	3.5D PHONE JACK (3P)	
CN2-4			E40-5487-05	PIN ASSY		J4		*	E06-0752-15	DIN SOCKET	
CN5			E04-0154-05	PIN SOCKET		J5		*	E58-0529-05	SUB SOCKET (D)	
CN6			E40-0211-05	PIN ASSY		J6		*	E58-0410-15	MODULAR JACK	
CN7			E04-0154-05	PIN SOCKET		J7		*	E06-0859-15	DIN SOCKET	
CN9			E40-0211-05	PIN ASSY		J8		*	E56-0408-15	DIN SOCKET	
CN10			E40-6525-05	PIN ASSY		J950			E06-0858-15	MIC CONNECTOR (8P)	
CN11		*	E40-6527-05	PIN ASSY		J951			E11-0705-05	PHONE JACK (9P)	E3,E5,J
CN12			E04-0154-05	PIN SOCKET		J951			E11-0705-05	PHONE JACK (9P)	J1,J2,J3
CN14			E04-0154-05	PIN SOCKET		J951			E11-0705-05	PHONE JACK (9P)	K1,K3,E1
CN16		*	E40-6527-05	PIN ASSY		J952			E11-0705-05	PHONE JACK (9P)	K2,E2,E4
CN17,18			E40-6525-05	PIN ASSY		W1		*	E37-0884-15	LEAD WIRE WITH CONNECTOR	
CN20		*	E40-6684-05	FLAT CABLE CONNECTOR		W2			E37-0954-05	LEAD WIRE WITH CONNECTOR	
CN21			E40-5747-05	SOCKET FOR PIN ASSY		-			F10-2003-14	SHIELDING CASE	
CN22,23			E04-0154-05	PIN SOCKET		F1			F53-0115-05	FUSE (1A/50V)	
CN24,25		*	E40-6656-05	PIN ASSY		CN30			J19-1570-05	HOLDER	
CN26,27			E40-5978-05	FLAT CABLE CONNECTOR		CF1			L72-0984-05	CERAMIC FILTER (455KHz)	
CN29			E40-5978-05	FLAT CABLE CONNECTOR		CF2			L72-0985-05	CERAMIC FILTER (455KHz)	
CN31			E40-6526-05	PIN ASSY		CF3			L72-0333-05	CERAMIC FILTER (455KHz)	
CN32		*	E40-6527-05	PIN ASSY		CF4			L72-0984-05	CERAMIC FILTER (455KHz)	
CN49			E04-0154-05	PIN SOCKET		L1		*	L41-1885-32	SMALL FIXED INDUCTOR (180NH)	
CN800			E40-5978-05	FLAT CABLE CONNECTOR	E3,E5,J	L2			L33-0695-05	SMALL FIXED INDUCTOR	
CN800			E40-5978-05	FLAT CABLE CONNECTOR	J1,J2,J3	L3,4			L40-6891-14	SMALL FIXED INDUCTOR	
CN801			E40-5736-05	FLAT CABLE CONNECTOR	K1,K3,E1	L5,6			L33-0695-05	SMALL FIXED INDUCTOR	
CN801			E40-5736-05	FLAT CABLE CONNECTOR	E3,E5,J	L7			L40-6891-15	SMALL FIXED INDUCTOR	E1,E2,E3
CN801			E40-5736-05	FLAT CABLE CONNECTOR	J1,J2,J3	L7			L40-6891-15	SMALL FIXED INDUCTOR	E4,E5
CN801			E40-5736-05	FLAT CABLE CONNECTOR	K1,K3,E1	L8			L33-0695-05	SMALL FIXED INDUCTOR	
CN804		*	E40-6527-05	PIN ASSY	E3,E5,J	L9			L40-6891-15	SMALL FIXED INDUCTOR	E1,E2,E3
CN804		*	E40-6527-05	PIN ASSY	J1,J2,J3	L9			L40-6891-15	SMALL FIXED INDUCTOR	E4,E5
CN804		*	E40-6527-05	PIN ASSY	K1,K3,E1	L9			L40-6891-15	SMALL FIXED INDUCTOR	
CN805			E40-5978-05	FLAT CABLE CONNECTOR	E3,E5,J	L10			L41-6895-33	SMALL FIXED INDUCTOR (6.8UH)	
CN805			E40-5978-05	FLAT CABLE CONNECTOR	J1,J2,J3	L11			L33-0695-05	SMALL FIXED INDUCTOR	
CN805			E40-5978-05	FLAT CABLE CONNECTOR	K1,K3,E1	L12,13		*	L41-2215-39	SMALL FIXED INDUCTOR (220U)	
CN806			E40-5741-05	FLAT CABLE CONNECTOR	E3,E5,J	L14			L40-1892-14	SMALL FIXED INDUCTOR	
CN806			E40-5741-05	FLAT CABLE CONNECTOR	J1,J2,J3	L15			L40-6891-14	SMALL FIXED INDUCTOR	
CN806			E40-5741-05	FLAT CABLE CONNECTOR	K1,K3,E1	L16			L40-1892-14	SMALL FIXED INDUCTOR	
CN950		*	E41-1686-05	PIN ASSY	E3,E5,J	L17			L40-1292-14	SMALL FIXED INDUCTOR	
CN950		*	E41-1686-05	PIN ASSY	J1,J2,J3	L18			L40-5691-14	SMALL FIXED INDUCTOR	
CN950		*	E41-1686-05	PIN ASSY	K1,K3,E1	L19			L40-1292-14	SMALL FIXED INDUCTOR	
CN951		*	E41-1687-05	PIN ASSY		L20			L40-1092-14	SMALL FIXED INDUCTOR	
CN952			E40-6074-05	FLAT CABLE CONNECTOR	E3,E5,J	L21			L40-3391-14	SMALL FIXED INDUCTOR	
CN952			E40-6074-05	FLAT CABLE CONNECTOR	J1,J2,J3	L22			L40-1092-14	SMALL FIXED INDUCTOR	
CN952			E40-6074-05	FLAT CABLE CONNECTOR	K1,K3,E1	L23-25		*	L34-4831-05	COIL	
CN953			E40-6077-05	FLAT CABLE CONNECTOR	E3,E5,J	L26			L40-3382-14	SMALL FIXED INDUCTOR	
CN953			E40-6077-05	FLAT CABLE CONNECTOR	J1,J2,J3	L27			L40-2792-14	SMALL FIXED INDUCTOR	
CN953			E40-6077-05	FLAT CABLE CONNECTOR	K1,K3,E1	L28			L40-3382-14	SMALL FIXED INDUCTOR	
CN956		*	E40-6610-05	PIN ASSY	E3,E5,J	L29			L40-2282-14	SMALL FIXED INDUCTOR	
CN956		*	E40-6610-05	PIN ASSY	J1,J2,J3	L30			L40-2292-14	SMALL FIXED INDUCTOR	
CN956		*	E40-6610-05	PIN ASSY	K1,K3,E1	L31			L40-2282-14	SMALL FIXED INDUCTOR	
CN957		*	E40-6594-05	PIN ASSY	E3,E5,J	L32-34		*	L34-4832-05	COIL	
CN957		*	E40-6594-05	PIN ASSY	J1,J2,J3	L35			L40-2282-14	SMALL FIXED INDUCTOR	
CN957		*	E40-6594-05	PIN ASSY	K1,K3,E1	L36			L40-1592-14	SMALL FIXED INDUCTOR	
CN958		*	E41-1686-05	PIN ASSY	K2,E2,E4	L37,38			L40-2282-14	SMALL FIXED INDUCTOR	

PARTS LIST

TX-RX 1 UNIT (X57-605X-XX)

Ref. No.	Address	New parts	Parts No.	Description	Desti-nation	Ref. No.	Address	New parts	Parts No.	Description	Desti-nation
L39			L40-1292-14	SMALL FIXED INDUCTOR		L126		*	L41-4705-39	SMALL FIXED INDUCTOR (47U)	
L40-43			L40-2282-14	SMALL FIXED INDUCTOR		L129-131		*	L41-1015-39	SMALL FIXED INDUCTOR (100U)	
L44		*	L34-4833-05	COIL		L132-135			L41-1095-39	SMALL FIXED INDUCTOR (1.0U)	
L45,46		*	L34-4819-05	COIL		L601,602			L41-1005-39	SMALL FIXED INDUCTOR (10U)	
L47			L33-0695-05	SMALL FIXED INDUCTOR		L603,604		*	L41-1015-39	SMALL FIXED INDUCTOR (100U)	
L48		*	L41-1588-40	SMALL FIXED INDUCTOR (150NH)		L605,606			L41-1005-39	SMALL FIXED INDUCTOR (10U)	
L49		*	L41-1088-40	SMALL FIXED INDUCTOR (100NH)		L607			L41-3395-39	SMALL FIXED INDUCTOR (3.3U)	
L50		*	L41-4705-39	SMALL FIXED INDUCTOR (47U)		L608		*	L41-3995-39	SMALL FIXED INDUCTOR (3.9U)	
L51			L19-0324-05	TOROIDAL COIL		L609,610			L41-1005-39	SMALL FIXED INDUCTOR (10U)	
L52			L39-1255-15	TOROIDAL COIL		L611			L41-2795-39	SMALL FIXED INDUCTOR (2.7U)	
L53		*	L41-1015-39	SMALL FIXED INDUCTOR (100U)		L612			L41-3395-39	SMALL FIXED INDUCTOR (3.3U)	
L54			L34-4413-05	COIL		L613		*	L34-4840-05	COIL	
L55			L33-0695-05	SMALL FIXED INDUCTOR		L614			L34-4649-05	COIL	
L56			L41-2295-39	SMALL FIXED INDUCTOR (2.2U)		L615		*	L41-1015-39	SMALL FIXED INDUCTOR (100U)	
L57			L33-1394-05	SMALL FIXED INDUCTOR		L616,617			L40-3301-37	SMALL FIXED INDUCTOR (33.00U)	
L58			L41-1085-33	SMALL FIXED INDUCTOR (100NH)		L618			L41-1005-39	SMALL FIXED INDUCTOR (10U)	
L59			L33-0695-05	SMALL FIXED INDUCTOR		L700		*	L41-1885-33	SMALL FIXED INDUCTOR (180NH)	
L60			L39-1255-15	TOROIDAL COIL		L701			L33-0695-05	SMALL FIXED INDUCTOR	
L61		*	L41-1015-39	SMALL FIXED INDUCTOR (100U)		L702			L41-2295-39	SMALL FIXED INDUCTOR (2.2U)	
L62		*	L34-4837-05	COIL		L703			L33-1394-05	SMALL FIXED INDUCTOR	
L63		*	L34-4836-05	COIL		L704			L41-1085-33	SMALL FIXED INDUCTOR (100NH)	
L64,65		*	L34-4837-05	COIL		L705			L33-0695-05	SMALL FIXED INDUCTOR	
L66		*	L34-4836-05	COIL		L706			L33-1394-05	SMALL FIXED INDUCTOR	
L67		*	L34-4837-05	COIL		L707			L40-1085-92	SMALL FIXED INDUCTOR (100NH)	
L68			L34-4415-05	COIL		L709		*	L41-3395-33	SMALL FIXED INDUCTOR (3.3UH)	
L69		*	L34-4829-05	COIL		L710-713			L40-3391-37	SMALL FIXED INDUCTOR (3.300UH)	
L70		*	L41-1015-39	SMALL FIXED INDUCTOR (100U)		L714,715			L41-1005-39	SMALL FIXED INDUCTOR (10U)	
L71			L34-4414-05	COIL		L716			L41-4705-33	SMALL FIXED INDUCTOR (47U)	
L72			L41-1085-33	SMALL FIXED INDUCTOR (100NH)		L717			L92-0131-05	CHIP FERRITE	
L73			L41-2285-33	SMALL FIXED INDUCTOR (220UH)		L718		*	L41-1015-39	SMALL FIXED INDUCTOR (100U)	
L74-77		*	L41-1015-39	SMALL FIXED INDUCTOR (100U)		L800,801		*	L41-1095-32	SMALL FIXED INDUCTOR (1UH)	E3,E5,J
L78			L33-0695-05	SMALL FIXED INDUCTOR		L800,801		*	L41-1095-32	SMALL FIXED INDUCTOR (1UH)	J1,J2,J3
L80		*	L41-4705-39	SMALL FIXED INDUCTOR (47U)		L800,801		*	L41-1095-32	SMALL FIXED INDUCTOR (1UH)	K1,K3,E1
L81,82		*	L34-4817-05	COIL		X1			L77-1827-05	CRYSTAL RESONATOR (10.595MHz)	
L83			L34-4787-05	COIL		X800			L77-1680-05	CRYSTAL RESONATOR (11.0592MHz)	E3,E5,J
L84-86		*	L41-2221-48	SMALL FIXED INDUCTOR (2200UH)		X800			L77-1680-05	CRYSTAL RESONATOR (11.0592MHz)	J1,J2,J3
L87		*	L34-4840-05	COIL		X800			L77-1680-05	CRYSTAL RESONATOR (11.0592MHz)	K1,K3,E1
L90		*	L41-4705-39	SMALL FIXED INDUCTOR (47U)		XF1			L71-0562-05	MCF (69.085M)	
L91			L41-1085-33	SMALL FIXED INDUCTOR (100NH)		XF2			L71-0561-05	MCF (75.925M)	
L92			L33-1394-05	SMALL FIXED INDUCTOR		XF5			L71-0433-15	MCF (10.695MHZ)	
L93			L33-0695-05	SMALL FIXED INDUCTOR		XF6		*	L71-0569-15	CRYSTAL FILTER (10.695MHz/2.7K)	
L94		*	L41-1015-39	SMALL FIXED INDUCTOR (100U)		XF9		*	L71-0570-15	CRYSTAL FILTER (10.595MHz/6K)	
L95			L19-0324-05	TOROIDAL COIL		CP1-3			RK74GB1J103J	CHIP-COM 10K J 1/16W	
L96		*	L34-4833-05	COIL		CP6-9			RK74GB1J103J	CHIP-COM 10K J 1/16W	
L97			L39-1255-15	TOROIDAL COIL		CP10,11			RK74GB1J101J	CHIP-COM 100 J 1/16W	
L98-100		*	L34-4833-05	COIL		CP801-804			RK74GB1J473J	CHIP-COM 47K J 1/16W	E3,E5,J
L101		*	L41-1015-39	SMALL FIXED INDUCTOR (100U)		CP801-804			RK74GB1J473J	CHIP-COM 47K J 1/16W	J1,J2,J3
L102		*	L34-4830-05	COIL		CP801-804			RK74GB1J473J	CHIP-COM 47K J 1/16W	
L103		*	L34-4825-05	COIL		CP805-808			RK74GB1J103J	CHIP-COM 10K J 1/16W	K1,K3,E1
L104			L41-1005-39	SMALL FIXED INDUCTOR (10U)		CP805-808			RK74GB1J103J	CHIP-COM 10K J 1/16W	E3,E5,J
L105		*	L34-4825-05	COIL		CP805-808			RK74GB1J103J	CHIP-COM 10K J 1/16W	J1,J2,J3
L106,107		*	L41-1015-39	SMALL FIXED INDUCTOR (100U)		CP805-810			RK74GB1J103J	CHIP-COM 10K J 1/16W	K1,K3,E1
L108,109		*	L34-4825-05	COIL		CP809,810			RK74GB1J473J	CHIP-COM 47K J 1/16W	E3,E5,J
L110-113		*	L41-1015-39	SMALL FIXED INDUCTOR (100U)		CP809,810			RK74GB1J473J	CHIP-COM 47K J 1/16W	J1,J2,J3
L115,116			L41-1095-39	SMALL FIXED INDUCTOR (1.0UH)		CP809,810			RK74GB1J473J	CHIP-COM 47K J 1/16W	K1,K3,E1
L117			L40-1021-13	SMALL FIXED INDUCTOR		R1			RK73EB2E560J	CHIP R 56 J 1/4W	
L118			L33-1425-05	CHOKE COIL		R2			RK73EB2E471J	CHIP R 470 J 1/4W	
L119			L33-0695-05	SMALL FIXED INDUCTOR		R3			RK73EB2E181J	CHIP R 180 J 1/4W	
L121			L41-1095-39	SMALL FIXED INDUCTOR (1.0U)		R4			RK73GB2A222J	CHIP R 2.2K J 1/10W	
L122-125		*	L41-1015-39	SMALL FIXED INDUCTOR (100U)		R5			RK73GB2A101J	CHIP R 100 J 1/10W	

J : TS-2000S J1 : TS-2000V J2 : TS-2000SX J3 : TS-2000VX
 K1 : TS-2000 (K) K2 : TS-B2000 (K) K3 : TS-2000X (K)
 E1 : TS-2000 (E) E2 : TS-B2000 (E) E3 : TS-2000 (E2) E4 : TS-B2000 (E2) E5 : TS-2000X (E)

PARTS LIST

TX-RX 1 UNIT (X57-605X-XX)

Ref. No.	Address	New parts	Parts No.	Description	Destination	Ref. No.	Address	New parts	Parts No.	Description	Destination
R6,7			RK73FB2B101J	CHIP R 100 J 1/8W		R83-86			RK73GB2A471J	CHIP R 470 J 1/10W	
R8			RK73GB2A472J	CHIP R 4.7K J 1/10W		R87			RK73GB2A222J	CHIP R 2.2K J 1/10W	
R9			RK73GB2A471J	CHIP R 470 J 1/10W		R88,89			RK73GB2A471J	CHIP R 470 J 1/10W	
R10			RK73GB2A560J	CHIP R 56 J 1/10W		R90			RK73GB2A273J	CHIP R 27K J 1/10W	
R11-13			RK73FB2B560J	CHIP R 56 J 1/8W		R91			RK73GB2A471J	CHIP R 470 J 1/10W	
R14			RK73GB2A330J	CHIP R 33 J 1/10W		R92			RK73GB2A823J	CHIP R 82K J 1/10W	
R15,16			RK73FB2B560J	CHIP R 56 J 1/8W		R93			RK73GB2A100J	CHIP R 10 J 1/10W	
R17			RK73GB2A330J	CHIP R 33 J 1/10W		R94			RK73GB2A101J	CHIP R 100 J 1/10W	
R18,19			RK73FB2B560J	CHIP R 56 J 1/8W		R95			RK73GB2A102J	CHIP R 1.0K J 1/10W	
R20			RK73GB2A330J	CHIP R 33 J 1/10W		R96			RK73GB2A000J	CHIP R 0.0 J 1/10W	
R21,22			RK73FB2B560J	CHIP R 56 J 1/8W		R97			RK73GB2A682J	CHIP R 6.8K J 1/10W	
R23			RK73GB2A330J	CHIP R 33 J 1/10W		R98			RK73GB2A000J	CHIP R 0.0 J 1/10W	
R24,25			RK73FB2B560J	CHIP R 56 J 1/8W		R99,100			RK73GB2A222J	CHIP R 2.2K J 1/10W	
R26			RK73GB2A330J	CHIP R 33 J 1/10W		R101			RK73GB2A102J	CHIP R 1.0K J 1/10W	
R27,28			RK73FB2B560J	CHIP R 56 J 1/8W		R102			RK73FB2B100J	CHIP R 10 J 1/8W	
R29			RK73GB2A330J	CHIP R 33 J 1/10W		R103			RK73GB2A682J	CHIP R 6.8K J 1/10W	
R30,31			RK73FB2B560J	CHIP R 56 J 1/8W		R104			RK73GB2A221J	CHIP R 220 J 1/10W	
R32			RK73GB2A330J	CHIP R 33 J 1/10W		R105			RK73GB2A821J	CHIP R 820 J 1/10W	
R33,34			RK73FB2B560J	CHIP R 56 J 1/8W		R106,107			RK73GB2A102J	CHIP R 1.0K J 1/10W	
R35			RK73GB2A330J	CHIP R 33 J 1/10W		R108			RK73GB2A101J	CHIP R 100 J 1/10W	
R36,37			RK73FB2B560J	CHIP R 56 J 1/8W		R110			RK73GB2A104J	CHIP R 100K J 1/10W	
R38			RK73GB2A330J	CHIP R 33 J 1/10W		R111			RK73GB2A222J	CHIP R 2.2K J 1/10W	
R39,40			RK73FB2B560J	CHIP R 56 J 1/8W		R113			RK73GB2A471J	CHIP R 470 J 1/10W	
R41			RK73GB2A330J	CHIP R 33 J 1/10W		R114			RK73GB2A222J	CHIP R 2.2K J 1/10W	
R42			RK73FB2B560J	CHIP R 56 J 1/8W		R115			RK73GB2A101J	CHIP R 100 J 1/10W	
R43			RK73GB2A330J	CHIP R 33 J 1/10W		R119			RK73GB2A104J	CHIP R 100K J 1/10W	
R44,45			RK73FB2B560J	CHIP R 56 J 1/8W		R120			RK73GB2A333J	CHIP R 33K J 1/10W	
R46			RK73GB2A151J	CHIP R 150 J 1/10W		R121			RK73GB2A103J	CHIP R 10K J 1/10W	
R47			RK73GB2A562J	CHIP R 5.6K J 1/10W		R122			RK73GB2A151J	CHIP R 150 J 1/10W	
R48			RK73GB2A471J	CHIP R 470 J 1/10W		R123			RK73GB2A471J	CHIP R 470 J 1/10W	
R49			RK73GB2A102J	CHIP R 1.0K J 1/10W		R124			RK73GB2A122J	CHIP R 1.2K J 1/10W	
R50,51			RK73GB2A681J	CHIP R 680 J 1/10W		R126			RK73GB2A000J	CHIP R 0.0 J 1/10W	
R52			RK73GB2A120J	CHIP R 12 J 1/10W		R127			RK73GB2A122J	CHIP R 1.2K J 1/10W	
R53,54			RK73GB2A100J	CHIP R 10 J 1/10W		R128			RK73GB2A152J	CHIP R 1.5K J 1/10W	
R55			RK73GB2A271J	CHIP R 270 J 1/10W		R131			RK73GB2A101J	CHIP R 100 J 1/10W	
R56,57			RK73GB2A100J	CHIP R 10 J 1/10W		R132			RK73GB2A000J	CHIP R 0.0 J 1/10W	
R58			RK73GB2A682J	CHIP R 6.8K J 1/10W		R133			RK73GB2A101J	CHIP R 100 J 1/10W	
R59			RK73FB2B100J	CHIP R 10 J 1/8W		R135			RK73GB2A000J	CHIP R 0.0 J 1/10W	
R60			RK73GB2A471J	CHIP R 470 J 1/10W		R137			RK73GB2A681J	CHIP R 680 J 1/10W	
R61			RK73GB2A151J	CHIP R 150 J 1/10W		R138			RK73GB2A152J	CHIP R 1.5K J 1/10W	
R62			RK73GB2A331J	CHIP R 330 J 1/10W		R139			RK73GB2A101J	CHIP R 100 J 1/10W	
R63			RK73GB2A681J	CHIP R 680 J 1/10W		R141			RK73GB2A681J	CHIP R 680 J 1/10W	
R64			RK73GB2A103J	CHIP R 10K J 1/10W		R142			RK73GB2A000J	CHIP R 0.0 J 1/10W	
R65			RK73FB2B100J	CHIP R 10 J 1/8W		R143			RK73GB2A681J	CHIP R 680 J 1/10W	
R66			RK73GB2A333J	CHIP R 33K J 1/10W		R144,145			RK73GB2A152J	CHIP R 1.5K J 1/10W	
R68			RK73GB2A331J	CHIP R 330 J 1/10W		R146			RK73GB2A101J	CHIP R 100 J 1/10W	
R69			RK73GB2A180J	CHIP R 18 J 1/10W		R147			RK73GB2A681J	CHIP R 680 J 1/10W	
R70			RK73GB2A331J	CHIP R 330 J 1/10W		R148			RK73GB2A821J	CHIP R 820 J 1/10W	
R71			RK73GB2A151J	CHIP R 150 J 1/10W		R149			RK73GB2A122J	CHIP R 1.2K J 1/10W	
R72			RK73GB2A000J	CHIP R 0.0 J 1/10W		R150			RK73GB2A681J	CHIP R 680 J 1/10W	
R73			RK73GB2A102J	CHIP R 1.0K J 1/10W		R151			RK73GB2A221J	CHIP R 220 J 1/10W	
R74			RK73GB2A100J	CHIP R 10 J 1/10W		R152			RK73GB2A102J	CHIP R 1.0K J 1/10W	
R75			RK73GB2A680J	CHIP R 68 J 1/10W		R153			RK73GB2A223J	CHIP R 22K J 1/10W	
R76			RK73GB2A180J	CHIP R 18 J 1/10W		R154			RK73GB2A000J	CHIP R 0.0 J 1/10W	
R77			RK73GB2A182J	CHIP R 1.8K J 1/10W		R155			RK73GB2A223J	CHIP R 22K J 1/10W	
R78			RK73GB2A102J	CHIP R 1.0K J 1/10W		R156			RK73GB2A333J	CHIP R 33K J 1/10W	
R79			RK73GB2A471J	CHIP R 470 J 1/10W		R157			RK73GB2A683J	CHIP R 68K J 1/10W	
R80			RK73GB2A103J	CHIP R 10K J 1/10W		R158,159			RK73GB2A103J	CHIP R 10K J 1/10W	
R81			RK73GB2A560J	CHIP R 56 J 1/10W		R160			RK73GB2A102J	CHIP R 1.0K J 1/10W	
R82			RK73GB2A103J	CHIP R 10K J 1/10W		R161			RK73GB2A152J	CHIP R 1.5K J 1/10W	

PARTS LIST

TX-RX 1 UNIT (X57-605X-XX)

Ref. No.	Address	New parts	Parts No.	Description	Desti-nation	Ref. No.	Address	New parts	Parts No.	Description	Desti-nation
R162			RK73GB2A223J	CHIP R 22K J 1/10W		R236			RK73GB2A472J	CHIP R 4.7K J 1/10W	
R163			RK73GB2A221J	CHIP R 220 J 1/10W		R237			RK73GB2A471J	CHIP R 470 J 1/10W	
R164			RK73GB2A333J	CHIP R 33K J 1/10W		R240			RK73GB2A100J	CHIP R 10 J 1/10W	
R165			RK73GB2A102J	CHIP R 1.0K J 1/10W		R241			RK73GB2A223J	CHIP R 22K J 1/10W	
R166			RK73GB2A563J	CHIP R 56K J 1/10W		R242,243			RK73GB2A472J	CHIP R 4.7K J 1/10W	
R167			RK73GB2A101J	CHIP R 100 J 1/10W		R244			RK73GB2A331J	CHIP R 330 J 1/10W	
R168			RK73GB2A681J	CHIP R 680 J 1/10W		R245			RK73GB2A180J	CHIP R 18 J 1/10W	
R169			RK73GB2A682J	CHIP R 6.8K J 1/10W		R246			RK73GB2A331J	CHIP R 330 J 1/10W	
R172			RK73GB2A104J	CHIP R 100K J 1/10W		R247			RK73FB2B100J	CHIP R 10 J 1/8W	
R173			RK73GB2A223J	CHIP R 22K J 1/10W		R248			RK73GB2A221J	CHIP R 220 J 1/10W	
R174			RK73GB2A471J	CHIP R 470 J 1/10W		R249			RK73GB2A681J	CHIP R 680 J 1/10W	
R175			RK73GB2A223J	CHIP R 22K J 1/10W		R250			RK73GB2A103J	CHIP R 10K J 1/10W	
R176			RK73GB2A822J	CHIP R 8.2K J 1/10W		R251			RK73GB2A333J	CHIP R 33K J 1/10W	
R177			RK73GB2A471J	CHIP R 470 J 1/10W		R252			RK73GB2A151J	CHIP R 150 J 1/10W	
R178			RK73GB2A560J	CHIP R 56 J 1/10W		R253			RK73GB2A101J	CHIP R 100 J 1/10W	
R179			RK73GB2A221J	CHIP R 220 J 1/10W		R254			RK73GB2A151J	CHIP R 150 J 1/10W	
R180			RK73GB2A274J	CHIP R 270K J 1/10W		R255			RK73GB2A000J	CHIP R 0.0 J 1/10W	
R181			RK73GB2A152J	CHIP R 1.5K J 1/10W		R256			RK73GB2A681J	CHIP R 680 J 1/10W	
R182			RK73GB2A333J	CHIP R 33K J 1/10W		R259,260			RK73GB2A2R2J	CHIP R 2.2 J 1/10W	
R183			RK73GB2A152J	CHIP R 1.5K J 1/10W		R261,262			RK73GB2A330J	CHIP R 33 J 1/10W	
R184			RK73GB2A101J	CHIP R 100 J 1/10W		R263			RK73GB2A473J	CHIP R 47K J 1/10W	
R185			RK73GB2A332J	CHIP R 3.3K J 1/10W		R264			RK73GB2A104J	CHIP R 100K J 1/10W	
R187			RK73GB2A101J	CHIP R 100 J 1/10W		R265			RK73GB2A273J	CHIP R 27K J 1/10W	
R188			RK73GB2A152J	CHIP R 1.5K J 1/10W		R266,267			RK73GB2A330J	CHIP R 33 J 1/10W	
R190			RK73GB2A332J	CHIP R 3.3K J 1/10W		R268			RK73GB2A273J	CHIP R 27K J 1/10W	
R191			RK73GB2A101J	CHIP R 100 J 1/10W		R269			RK73GB2A102J	CHIP R 1.0K J 1/10W	
R192			RK73GB2A332J	CHIP R 3.3K J 1/10W		R270			RK73GB2A273J	CHIP R 27K J 1/10W	
R194			RK73GB2A101J	CHIP R 100 J 1/10W		R272-274			RK73GB2A104J	CHIP R 100K J 1/10W	
R196			RK73GB2A222J	CHIP R 2.2K J 1/10W		R275,276			RK73GB2A101J	CHIP R 100 J 1/10W	
R197			RK73GB2A101J	CHIP R 100 J 1/10W		R277,278			RK73GB2A331J	CHIP R 330 J 1/10W	
R198			RK73GB2A332J	CHIP R 3.3K J 1/10W		R279			RK73GB2A472J	CHIP R 4.7K J 1/10W	
R200			RK73GB2A101J	CHIP R 100 J 1/10W		R280,281			RK73GB2A330J	CHIP R 33 J 1/10W	
R201			RK73GB2A103J	CHIP R 10K J 1/10W		R282,283			RK73GB2A680J	CHIP R 68 J 1/10W	
R202			RK73GB2A332J	CHIP R 3.3K J 1/10W		R284			RK73GB2A103J	CHIP R 10K J 1/10W	
R203,204			RK73GB2A154J	CHIP R 150K J 1/10W		R285			RK73GB2A472J	CHIP R 4.7K J 1/10W	
R205			RK73GB2A563J	CHIP R 56K J 1/10W		R286			RK73GB2A000J	CHIP R 0.0 J 1/10W	
R206			RK73GB2A682J	CHIP R 6.8K J 1/10W		R287,288			RK73GB2A102J	CHIP R 1.0K J 1/10W	
R209			RK73GB2A470J	CHIP R 47 J 1/10W		R289			RK73GB2A471J	CHIP R 470 J 1/10W	
R210			RK73GB2A102J	CHIP R 1.0K J 1/10W		R290			RK73GB2A151J	CHIP R 150 J 1/10W	
R211,212			RK73GB2A103J	CHIP R 10K J 1/10W		R291			RK73GB2A124J	CHIP R 120K J 1/10W	
R213			RK73GB2A223J	CHIP R 22K J 1/10W		R292			RK73GB2A330J	CHIP R 33 J 1/10W	
R214			RK73GB2A122J	CHIP R 1.2K J 1/10W		R293			RK73GB2A681J	CHIP R 680 J 1/10W	
R215,216			RK73GB2A332J	CHIP R 3.3K J 1/10W		R294			RK73GB2A103J	CHIP R 10K J 1/10W	
R217			RK73GB2A104J	CHIP R 100K J 1/10W		R295			RK73GB2A682J	CHIP R 6.8K J 1/10W	
R218			RK73GB2A333J	CHIP R 33K J 1/10W		R296			RK73GB2A103J	CHIP R 10K J 1/10W	
R219			RK73GB2A471J	CHIP R 470 J 1/10W		R297,298			RK73GB2A122J	CHIP R 1.2K J 1/10W	
R220			RK73GB2A223J	CHIP R 22K J 1/10W		R299			RK73GB2A681J	CHIP R 680 J 1/10W	
R221			RK73GB2A101J	CHIP R 100 J 1/10W		R300			RK73GB2A223J	CHIP R 22K J 1/10W	
R222			RK73GB2A222J	CHIP R 2.2K J 1/10W		R301			RK73GB2A561J	CHIP R 560 J 1/10W	
R223			RK73GB2A221J	CHIP R 220 J 1/10W		R302			RK73GB2A682J	CHIP R 6.8K J 1/10W	
R224			RK73GB2A682J	CHIP R 6.8K J 1/10W		R303			RK73GB2A102J	CHIP R 1.0K J 1/10W	
R225			RK73GB2A331J	CHIP R 330 J 1/10W		R304			RK73GB2A223J	CHIP R 22K J 1/10W	
R226			RK73GB2A152J	CHIP R 1.5K J 1/10W		R305			RK73GB2A151J	CHIP R 150 J 1/10W	
R227			RK73GB2A000J	CHIP R 0.0 J 1/10W		R306			RK73GB2A103J	CHIP R 10K J 1/10W	
R228			RK73GB2A331J	CHIP R 330 J 1/10W		R307			RK73GB2A681J	CHIP R 680 J 1/10W	
R229			RK73GB2A101J	CHIP R 100 J 1/10W		R308			RK73GB2A472J	CHIP R 4.7K J 1/10W	
R230-232			RK73GB2A102J	CHIP R 1.0K J 1/10W		R309			RK73GB2A101J	CHIP R 100 J 1/10W	
R233			RK73GB2A154J	CHIP R 150K J 1/10W		R310			RK73GB2A333J	CHIP R 33K J 1/10W	
R234			RK73GB2A101J	CHIP R 100 J 1/10W		R311			RK73GB2A223J	CHIP R 22K J 1/10W	
R235			RK73GB2A124J	CHIP R 120K J 1/10W		R313			RK73GB2A681J	CHIP R 680 J 1/10W	

PARTS LIST

TX-RX 1 UNIT (X57-605X-XX)

Ref. No.	Address	New parts	Parts No.	Description	Destination	Ref. No.	Address	New parts	Parts No.	Description	Destination
R315			RK73GB2A222J	CHIP R 2.2K J 1/10W		R392			RK73GB2A100J	CHIP R 10 J 1/10W	
R316			RK73GB2A682J	CHIP R 6.8K J 1/10W		R397			RK73GB2A104J	CHIP R 100K J 1/10W	
R317			RK73GB2A102J	CHIP R 1.0K J 1/10W		R398,399			RK73GB2A000J	CHIP R 0.0 J 1/10W	
R318			RK73GB2A333J	CHIP R 33K J 1/10W		R400			RK73GB2A103J	CHIP R 10K J 1/10W	
R319			RK73GB2A562J	CHIP R 5.6K J 1/10W		R401-404			RK73GB2A101J	CHIP R 100 J 1/10W	
R320			RK73GB2A473J	CHIP R 47K J 1/10W		R405-408			RK73GB2A2R2J	CHIP R 2.2 J 1/10W	
R321			RK73GB2A223J	CHIP R 22K J 1/10W		R409			RK73GB2A104J	CHIP R 100K J 1/10W	
R322-324			RK73GB2A473J	CHIP R 47K J 1/10W		R410			RK73GB2A334J	CHIP R 330K J 1/10W	E1,E2,E3
R325			RK73GB2A222J	CHIP R 2.2K J 1/10W		R410			RK73GB2A334J	CHIP R 330K J 1/10W	E4,E5,J
R326			RK73GB2A330J	CHIP R 33 J 1/10W		R410			RK73GB2A334J	CHIP R 330K J 1/10W	J2
R327			RK73GB2A102J	CHIP R 1.0K J 1/10W		R410			RK73GB2A334J	CHIP R 330K J 1/10W	K1,K2,K3
R328			RK73GB2A122J	CHIP R 1.2K J 1/10W		R411			RK73GB2A822J	CHIP R 8.2K J 1/10W	
R329			RK73GB2A182J	CHIP R 1.8K J 1/10W		R412			RK73GB2A222J	CHIP R 2.2K J 1/10W	
R330			RK73GB2A681J	CHIP R 680 J 1/10W		R413			RK73GB2A103J	CHIP R 10K J 1/10W	
R331			RK73GB2A122J	CHIP R 1.2K J 1/10W		R414			RK73GB2A153J	CHIP R 15K J 1/10W	
R332			RK73GB2A331J	CHIP R 330 J 1/10W		R415,416			RK73GB2A102J	CHIP R 1.0K J 1/10W	
R333			RK73GB2A471J	CHIP R 470 J 1/10W		R417			RK73GB2A222J	CHIP R 2.2K J 1/10W	
R334			RK73GB2A101J	CHIP R 100 J 1/10W		R418,419			RK73GB2A331J	CHIP R 330 J 1/10W	
R335			RK73GB2A681J	CHIP R 680 J 1/10W		R420			RK73GB2A102J	CHIP R 1.0K J 1/10W	
R336			RK73GB2A222J	CHIP R 2.2K J 1/10W		R421			RK73GB2A101J	CHIP R 100 J 1/10W	
R337			RK73GB2A224J	CHIP R 220K J 1/10W		R422			RK73GB2A104J	CHIP R 100K J 1/10W	
R338			RK73GB2A331J	CHIP R 330 J 1/10W		R423			RK73GB2A153J	CHIP R 15K J 1/10W	
R339			RK73GB2A101J	CHIP R 100 J 1/10W		R424			RK73GB2A222J	CHIP R 2.2K J 1/10W	
R340			RK73GB2A274J	CHIP R 270K J 1/10W		R425			RK73GB2A332J	CHIP R 3.3K J 1/10W	
R341,342			RK73GB2A103J	CHIP R 10K J 1/10W		R426			RK73GB2A104J	CHIP R 100K J 1/10W	
R343			RK73GB2A681J	CHIP R 680 J 1/10W		R427			RK73GB2A332J	CHIP R 3.3K J 1/10W	
R344			RK73GB2A223J	CHIP R 22K J 1/10W		R428			RK73GB2A822J	CHIP R 8.2K J 1/10W	
R345			RK73GB2A332J	CHIP R 3.3K J 1/10W		R429			RK73GB2A100J	CHIP R 10 J 1/10W	
R346			RK73GB2A681J	CHIP R 680 J 1/10W		R430			RK73GB2A000J	CHIP R 0.0 J 1/10W	
R347			RK73GB2A471J	CHIP R 470 J 1/10W		R431			RK73GB2A104J	CHIP R 100K J 1/10W	
R348			RK73GB2A332J	CHIP R 3.3K J 1/10W		R432			RK73GB2A000J	CHIP R 0.0 J 1/10W	
R349			RK73GB2A101J	CHIP R 100 J 1/10W		R433-435			RK73GB2A104J	CHIP R 100K J 1/10W	
R350			RK73GB2A102J	CHIP R 1.0K J 1/10W		R438,439			RK73GB2A104J	CHIP R 100K J 1/10W	
R351			RK73GB2A223J	CHIP R 22K J 1/10W		R440			RK73GB2A224J	CHIP R 220K J 1/10W	
R352			RK73GB2A683J	CHIP R 68K J 1/10W		R442			RK73GB2A273J	CHIP R 27K J 1/10W	
R355			RK73GB2A102J	CHIP R 1.0K J 1/10W		R443			RK73GB2A000J	CHIP R 0.0 J 1/10W	
R356			RK73GB2A474J	CHIP R 470K J 1/10W		R444			RK73GB2A103J	CHIP R 10K J 1/10W	
R359			RK73GB2A104J	CHIP R 100K J 1/10W		R445			RK73GB2A102J	CHIP R 1.0K J 1/10W	
R361			RK73GB2A103J	CHIP R 10K J 1/10W		R446-448			RK73GB2A104J	CHIP R 100K J 1/10W	
R364			RK73GB2A473J	CHIP R 47K J 1/10W		R449			RK73GB2A221J	CHIP R 220 J 1/10W	
R365			RK73GB2A273J	CHIP R 27K J 1/10W		R450			RK73GB2A102J	CHIP R 1.0K J 1/10W	
R366			RK73GB2A271J	CHIP R 270 J 1/10W		R451			RK73GB2A272J	CHIP R 2.7K J 1/10W	
R367,368			RK73GB2A477J	CHIP R 4.7 J 1/10W		R452,453			RK73GB2A000J	CHIP R 0.0 J 1/10W	
R369			RK73GB2A271J	CHIP R 270 J 1/10W		R454,455			RK73GB2A101J	CHIP R 100 J 1/10W	
R370			RK73GB2A273J	CHIP R 27K J 1/10W		R460-475			RK73GB2A102J	CHIP R 1.0K J 1/10W	
R371			RK73GB2A102J	CHIP R 1.0K J 1/10W		R476			RK73GB2A563J	CHIP R 56K J 1/10W	
R372			RK73GB2A473J	CHIP R 47K J 1/10W		R477			RK73GB2A103J	CHIP R 10K J 1/10W	
R373,374			RK73GB2A472J	CHIP R 4.7K J 1/10W		R478			RK73GB2A000J	CHIP R 0.0 J 1/10W	
R375			RK73GB2A102J	CHIP R 1.0K J 1/10W		R479			RK73GB2A473J	CHIP R 47K J 1/10W	
R376			RK73GB2A331J	CHIP R 330 J 1/10W		R480			RK73GB2A563J	CHIP R 56K J 1/10W	
R377			RK73GB2A183J	CHIP R 18K J 1/10W		R481			RK73GB2A103J	CHIP R 10K J 1/10W	
R378			RK73GB2A331J	CHIP R 330 J 1/10W		R482			RK73GB2A334J	CHIP R 330K J 1/10W	
R379			RK73GB2A272J	CHIP R 2.7K J 1/10W		R483			RK73GB2A000J	CHIP R 0.0 J 1/10W	
R380,381			RK73GB2A223J	CHIP R 22K J 1/10W		R484			RK73GB2A474J	CHIP R 470K J 1/10W	
R382			RK73GB2A471J	CHIP R 470 J 1/10W		R485			RK73GB2A124J	CHIP R 120K J 1/10W	E1,E2,E3
R383			RK73GB2A223J	CHIP R 22K J 1/10W		R485			RK73GB2A124J	CHIP R 120K J 1/10W	E4,E5,J
R384,385			RK73GB2A101J	CHIP R 100 J 1/10W		R485			RK73GB2A124J	CHIP R 120K J 1/10W	J2
R386			RK73GB2A103J	CHIP R 10K J 1/10W		R485			RK73GB2A124J	CHIP R 120K J 1/10W	K1,K2,K3
R387			RK73GB2A472J	CHIP R 4.7K J 1/10W		R485			RK73GB2A394J	CHIP R 390K J 1/10W	J1,J3
R391			RK73GB2A103J	CHIP R 10K J 1/10W		R486			RK73GB2A224J	CHIP R 220K J 1/10W	

PARTS LIST

TX-RX 1 UNIT (X57-605X-XX)

Ref. No.	Address	New parts	Parts No.	Description	Desti-nation	Ref. No.	Address	New parts	Parts No.	Description	Desti-nation
R487			RK73GB2A104J	CHIP R 100K J 1/10W		R727			RK73GB2A121J	CHIP R 120 J 1/10W	
R488			RK73GB2A101J	CHIP R 100 J 1/10W		R728			RK73GB2A471J	CHIP R 470 J 1/10W	
R489			RK73GB2A104J	CHIP R 100K J 1/10W		R729			RK73GB2A221J	CHIP R 220 J 1/10W	
R491,492			RK73GB2A102J	CHIP R 1.0K J 1/10W		R731			RK73GB2A102J	CHIP R 1.0K J 1/10W	
R493-496			RK73GB2A101J	CHIP R 100 J 1/10W		R732			RK73GB2A103J	CHIP R 10K J 1/10W	
R497-499			RK73GB2A471J	CHIP R 470 J 1/10W		R733			RK73GB2A472J	CHIP R 4.7K J 1/10W	
R500-502			RK73GB2A104J	CHIP R 100K J 1/10W		R734			RK73GB2A000J	CHIP R 0.0 J 1/10W	
R503,504			RK73GB2A101J	CHIP R 100 J 1/10W		R735			RK73GB2A104J	CHIP R 100K J 1/10W	
R505			RK73GB2A151J	CHIP R 150 J 1/10W		R736			RK73GB2A473J	CHIP R 47K J 1/10W	
R506,507			RK73GB2A101J	CHIP R 100 J 1/10W		R737			RK73GB2A472J	CHIP R 4.7K J 1/10W	
R508			RK73GB2A123J	CHIP R 12K J 1/10W		R738			RK73GB2A182J	CHIP R 1.8K J 1/10W	
R509			RK73GB2A103J	CHIP R 10K J 1/10W		R739,740			RK73GB2A103J	CHIP R 10K J 1/10W	
R601			RK73GB2A101J	CHIP R 100 J 1/10W		R741			RK73GB2A151J	CHIP R 150 J 1/10W	
R602			RK73GB2A823J	CHIP R 82K J 1/10W		R742			RK73GB2A331J	CHIP R 330 J 1/10W	
R603			RK73GB2A561J	CHIP R 560 J 1/10W		R743,744			RK73GB2A103J	CHIP R 10K J 1/10W	
R604			RK73GB2A392J	CHIP R 3.9K J 1/10W		R745			RK73FB2B100J	CHIP R 10 J 1/8W	
R605			RK73GB2A331J	CHIP R 330 J 1/10W		R746			RK73GB2A333J	CHIP R 33K J 1/10W	
R607			RK73GB2A822J	CHIP R 8.2K J 1/10W		R747			RK73GB2A103J	CHIP R 10K J 1/10W	
R608			RK73GB2A153J	CHIP R 15K J 1/10W		R748			RK73GB2A331J	CHIP R 330 J 1/10W	
R609			RK73GB2A181J	CHIP R 180 J 1/10W		R749			RK73GB2A180J	CHIP R 18 J 1/10W	
R610			RK73GB2A221J	CHIP R 220 J 1/10W		R750			RK73GB2A331J	CHIP R 330 J 1/10W	
R611			RK73GB2A101J	CHIP R 100 J 1/10W		R751			RK73GB2A151J	CHIP R 150 J 1/10W	
R612			RK73GB2A823J	CHIP R 82K J 1/10W		R752			RK73GB2A223J	CHIP R 22K J 1/10W	
R613			RK73GB2A561J	CHIP R 560 J 1/10W		R753			RK73GB2A564J	CHIP R 560K J 1/10W	
R614			RK73GB2A392J	CHIP R 3.9K J 1/10W		R754			RK73GB2A222J	CHIP R 2.2K J 1/10W	
R615			RK73GB2A331J	CHIP R 330 J 1/10W		R755			RK73GB2A000J	CHIP R 0.0 J 1/10W	
R616			RK73GB2A101J	CHIP R 100 J 1/10W		R756			RK73GB2A393J	CHIP R 39K J 1/10W	
R617			RK73GB2A822J	CHIP R 8.2K J 1/10W		R757			RK73GB2A333J	CHIP R 33K J 1/10W	
R618			RK73GB2A153J	CHIP R 15K J 1/10W		R758			RK73GB2A103J	CHIP R 10K J 1/10W	
R619			RK73GB2A181J	CHIP R 180 J 1/10W		R759			RK73GB2A000J	CHIP R 0.0 J 1/10W	
R621			RK73GB2A101J	CHIP R 100 J 1/10W		R760			RK73GB2A102J	CHIP R 1.0K J 1/10W	
R622			RK73GB2A823J	CHIP R 82K J 1/10W		R761			RK73GB2A101J	CHIP R 100 J 1/10W	
R623			RK73GB2A561J	CHIP R 560 J 1/10W		R762			RK73GB2A222J	CHIP R 2.2K J 1/10W	
R624			RK73GB2A392J	CHIP R 3.9K J 1/10W		R763			RK73GB2A101J	CHIP R 100 J 1/10W	
R625			RK73GB2A331J	CHIP R 330 J 1/10W		R764			RK73GB2A152J	CHIP R 1.5K J 1/10W	
R626			RK73GB2A101J	CHIP R 100 J 1/10W		R765			RK73GB2A182J	CHIP R 1.8K J 1/10W	
R627			RK73GB2A822J	CHIP R 8.2K J 1/10W		R766			RK73GB2A221J	CHIP R 220 J 1/10W	
R628			RK73GB2A153J	CHIP R 15K J 1/10W		R767			RK73GB2A000J	CHIP R 0.0 J 1/10W	J1,J3
R629			RK73GB2A181J	CHIP R 180 J 1/10W		R767			RK73GB2A103J	CHIP R 10K J 1/10W	E1,E2,E3
R630			RK73GB2A221J	CHIP R 220 J 1/10W		R767			RK73GB2A103J	CHIP R 10K J 1/10W	E4,E5,J
R631			RK73GB2A103J	CHIP R 10K J 1/10W		R767			RK73GB2A103J	CHIP R 10K J 1/10W	J2
R632-639			RK73GB2A331J	CHIP R 330 J 1/10W		R767			RK73GB2A103J	CHIP R 10K J 1/10W	K1,K2,K3
R640			RK73GB2A222J	CHIP R 2.2K J 1/10W		R768			RK73GB2A471J	CHIP R 470 J 1/10W	
R641			RK73GB2A101J	CHIP R 100 J 1/10W		R769			RK73GB2A223J	CHIP R 22K J 1/10W	
R642			RK73GB2A222J	CHIP R 2.2K J 1/10W		R770			RK73GB2A472J	CHIP R 4.7K J 1/10W	
R643,644			RK73GB2A102J	CHIP R 1.0K J 1/10W		R771			RK73GB2A104J	CHIP R 100K J 1/10W	
R700			RK73GB2A101J	CHIP R 100 J 1/10W		R772			RK73GB2A684J	CHIP R 680K J 1/10W	
R701			RK73GB2A103J	CHIP R 10K J 1/10W		R773			RK73GB2A391J	CHIP R 390 J 1/10W	
R702,703			RK73GB2A471J	CHIP R 470 J 1/10W		R774			RK73GB2A101J	CHIP R 100 J 1/10W	
R704			RK73GB2A473J	CHIP R 47K J 1/10W		R775			RK73GB2A392J	CHIP R 3.9K J 1/10W	
R707-710			RK73GB2A472J	CHIP R 4.7K J 1/10W		R776			RK73GB2A562J	CHIP R 5.6K J 1/10W	
R711			RK73GB2A103J	CHIP R 10K J 1/10W		R777			RK73GB2A473J	CHIP R 47K J 1/10W	
R712,713			RK73GB2A101J	CHIP R 100 J 1/10W		R778			RK73GB2A184J	CHIP R 180K J 1/10W	
R714,715			RK73GB2A471J	CHIP R 470 J 1/10W		R779			RK73GB2A102J	CHIP R 1.0K J 1/10W	
R717,718			RK73GB2A104J	CHIP R 100K J 1/10W		R780			RK73GB2A101J	CHIP R 100 J 1/10W	
R719			RK73GB2A393J	CHIP R 39K J 1/10W		R781			RK73GB2A152J	CHIP R 1.5K J 1/10W	
R720			RK73GB2A102J	CHIP R 1.0K J 1/10W		R782			RK73GB2A124J	CHIP R 120K J 1/10W	
R721			RK73GB2A101J	CHIP R 100 J 1/10W		R783			RK73GB2A122J	CHIP R 1.2K J 1/10W	
R722			RK73GB2A471J	CHIP R 470 J 1/10W		R784			RK73GB2A333J	CHIP R 33K J 1/10W	
R725			RK73GB2A562J	CHIP R 5.6K J 1/10W		R785,786			RK73GB2A2R2J	CHIP R 2.2 J 1/10W	

J : TS-2000S J1 : TS-2000V J2 : TS-2000SX J3 : TS-2000VX
 K1 : TS-2000 (K) K2 : TS-B2000 (K) K3 : TS-2000X (K)
 E1 : TS-2000 (E) E2 : TS-B2000 (E) E3 : TS-2000 (E2) E4 : TS-B2000 (E2) E5 : TS-2000X (E)

PARTS LIST

TX-RX 1 UNIT (X57-605X-XX)

Ref. No.	Address	New parts	Parts No.	Description	Destination	Ref. No.	Address	New parts	Parts No.	Description	Destination
R787			RK73FB2B473J	CHIP R 47K J 1/8W		R872			RK73GB2A103J	CHIP R 10K J 1/10W	E3,E5,J
R788			RK73GB2A182J	CHIP R 1.8K J 1/10W		R872			RK73GB2A103J	CHIP R 10K J 1/10W	J1,J2,J3
R789-791			RK73GB2A102J	CHIP R 1.0K J 1/10W		R872			RK73GB2A103J	CHIP R 10K J 1/10W	K1,K3,E1
R800			RK73FB2B681J	CHIP R 680 J 1/8W	E3,E5,J	R873			RK73GB2A101J	CHIP R 100 J 1/10W	E3,E5,J
R800			RK73FB2B681J	CHIP R 680 J 1/8W	J1,J2,J3	R873			RK73GB2A101J	CHIP R 100 J 1/10W	J1,J2,J3
R800			RK73FB2B681J	CHIP R 680 J 1/8W	K1,K3,E1	R873			RK73GB2A101J	CHIP R 100 J 1/10W	K1,K3,E1
R801			RK73FB2B222J	CHIP R 2.2K J 1/8W	E3,E5,J	R874			RK73GB2A103J	CHIP R 10K J 1/10W	E3,E5,J
R801			RK73FB2B222J	CHIP R 2.2K J 1/8W	J1,J2,J3	R874			RK73GB2A103J	CHIP R 10K J 1/10W	J1,J2,J3
R801			RK73FB2B222J	CHIP R 2.2K J 1/8W	K1,K3,E1	R874			RK73GB2A103J	CHIP R 10K J 1/10W	K1,K3,E1
R802			RK73FB2B681J	CHIP R 680 J 1/8W	E3,E5,J	R875			RK73GB2A101J	CHIP R 100 J 1/10W	E3,E5,J
R802			RK73FB2B681J	CHIP R 680 J 1/8W	J1,J2,J3	R875			RK73GB2A101J	CHIP R 100 J 1/10W	J1,J2,J3
R802			RK73FB2B681J	CHIP R 680 J 1/8W	K1,K3,E1	R875			RK73GB2A101J	CHIP R 100 J 1/10W	K1,K3,E1
R803			RK73FB2B102J	CHIP R 1.0K J 1/8W	E3,E5,J	R876			RK73GB2A103J	CHIP R 10K J 1/10W	E3,E5,J
R803			RK73FB2B102J	CHIP R 1.0K J 1/8W	J1,J2,J3	R876			RK73GB2A103J	CHIP R 10K J 1/10W	J1,J2,J3
R803			RK73FB2B102J	CHIP R 1.0K J 1/8W	K1,K3,E1	R876			RK73GB2A103J	CHIP R 10K J 1/10W	K1,K3,E1
R804			RK73FB2B681J	CHIP R 680 J 1/8W	E3,E5,J	R877			RK73GB2A101J	CHIP R 100 J 1/10W	E3,E5,J
R804			RK73FB2B681J	CHIP R 680 J 1/8W	J1,J2,J3	R877			RK73GB2A101J	CHIP R 100 J 1/10W	J1,J2,J3
R804			RK73FB2B681J	CHIP R 680 J 1/8W	K1,K3,E1	R877			RK73GB2A101J	CHIP R 100 J 1/10W	K1,K3,E1
R805			RK73FB2B682J	CHIP R 6.8K J 1/8W	E3,E5,J	R878			RK73GB2A103J	CHIP R 10K J 1/10W	E3,E5,J
R805			RK73FB2B682J	CHIP R 6.8K J 1/8W	J1,J2,J3	R878			RK73GB2A103J	CHIP R 10K J 1/10W	J1,J2,J3
R805			RK73FB2B682J	CHIP R 6.8K J 1/8W	K1,K3,E1	R878			RK73GB2A103J	CHIP R 10K J 1/10W	K1,K3,E1
R806			RK73FB2B681J	CHIP R 680 J 1/8W	E3,E5,J	R879-881			RK73GB2A101J	CHIP R 100 J 1/10W	E3,E5,J
R806			RK73FB2B681J	CHIP R 680 J 1/8W	J1,J2,J3	R879-881			RK73GB2A101J	CHIP R 100 J 1/10W	J1,J2,J3
R806			RK73FB2B681J	CHIP R 680 J 1/8W	K1,K3,E1	R879-881			RK73GB2A101J	CHIP R 100 J 1/10W	K1,K3,E1
R807			RK73FB2B102J	CHIP R 1.0K J 1/8W	E3,E5,J	R884,885			RK73GB2A103J	CHIP R 10K J 1/10W	E3,E5,J
R807			RK73FB2B102J	CHIP R 1.0K J 1/8W	J1,J2,J3	R884,885			RK73GB2A103J	CHIP R 10K J 1/10W	J1,J2,J3
R807			RK73FB2B102J	CHIP R 1.0K J 1/8W	K1,K3,E1	R884,885			RK73GB2A103J	CHIP R 10K J 1/10W	K1,K3,E1
R808			RK73FB2B681J	CHIP R 680 J 1/8W	E3,E5,J	R886			RK73GB2A473J	CHIP R 47K J 1/10W	E3,E5,J
R808			RK73FB2B681J	CHIP R 680 J 1/8W	J1,J2,J3	R886			RK73GB2A473J	CHIP R 47K J 1/10W	J1,J2,J3
R808			RK73FB2B681J	CHIP R 680 J 1/8W	K1,K3,E1	R886			RK73GB2A473J	CHIP R 47K J 1/10W	K1,K3,E1
R809			RK73FB2B222J	CHIP R 2.2K J 1/8W	E3,E5,J	R887-898			RK73GB2A101J	CHIP R 100 J 1/10W	E3,E5,J
R809			RK73FB2B222J	CHIP R 2.2K J 1/8W	J1,J2,J3	R887-898			RK73GB2A101J	CHIP R 100 J 1/10W	J1,J2,J3
R809			RK73FB2B222J	CHIP R 2.2K J 1/8W	K1,K3,E1	R887-898			RK73GB2A101J	CHIP R 100 J 1/10W	K1,K3,E1
R818-822			RK73GB2A101J	CHIP R 100 J 1/10W	E3,E5,J	R899			RK73FB2B680J	CHIP R 68 J 1/8W	E3,E5,J
R818-822			RK73GB2A101J	CHIP R 100 J 1/10W	J1,J2,J3	R899			RK73FB2B680J	CHIP R 68 J 1/8W	J1,J2,J3
R818-822			RK73GB2A101J	CHIP R 100 J 1/10W	K1,K3,E1	R899			RK73FB2B680J	CHIP R 68 J 1/8W	K1,K3,E1
R823			RK73GB2A000J	CHIP R 0.0 J 1/10W	E3,E5,J	R950,951			R92-1205-05	CHIP R 120 J 1/4W	E3,E5,J
R823			RK73GB2A000J	CHIP R 0.0 J 1/10W	J1,J2,J3	R950,951			R92-1205-05	CHIP R 120 J 1/4W	J1,J2,J3
R823			RK73GB2A000J	CHIP R 0.0 J 1/10W	K1,K3,E1	R950,951			R92-1205-05	CHIP R 120 J 1/4W	K1,K3,E1
R824			RK73FB2B000J	CHIP R 0.0 J 1/8W	E3,E5,J	R952-955			RK73FB2B470J	CHIP R 47 J 1/8W	E3,E5,J
R824			RK73FB2B000J	CHIP R 0.0 J 1/8W	J1,J2,J3	R956-960			RK73FB2B681J	CHIP R 680 J 1/8W	E3,E5,J
R824			RK73FB2B000J	CHIP R 0.0 J 1/8W	K1,K3,E1	R956-960			RK73FB2B681J	CHIP R 680 J 1/8W	J1,J2,J3
R841			RK73GB2A473J	CHIP R 47K J 1/10W	E3,E5,J	R956-960			RK73FB2B681J	CHIP R 680 J 1/8W	K1,K3,E1
R841			RK73GB2A473J	CHIP R 47K J 1/10W	J1,J2,J3	R962			RK73GB2A473J	CHIP R 47K J 1/10W	E3,E5,J
R841			RK73GB2A473J	CHIP R 47K J 1/10W	K1,K3,E1	R962			RK73GB2A473J	CHIP R 47K J 1/10W	J1,J2,J3
R842			RK73GB2A000J	CHIP R 0.0 J 1/10W	E3,E5,J	R962			RK73GB2A473J	CHIP R 47K J 1/10W	K1,K3,E1
R842			RK73GB2A000J	CHIP R 0.0 J 1/10W	J1,J2,J3	R964			RK73GB2A473J	CHIP R 47K J 1/10W	E3,E5,J
R842			RK73GB2A000J	CHIP R 0.0 J 1/10W	K1,K3,E1	R964			RK73GB2A473J	CHIP R 47K J 1/10W	J1,J2,J3
R846-853			RK73GB2A101J	CHIP R 100 J 1/10W	E3,E5,J	R964			RK73GB2A473J	CHIP R 47K J 1/10W	K1,K3,E1
R846-853			RK73GB2A101J	CHIP R 100 J 1/10W	J1,J2,J3	R970,971			R92-1205-05	CHIP R 120 J 1/4W	K2,E2,E4
R846-853			RK73GB2A101J	CHIP R 100 J 1/10W	K1,K3,E1	R972			RK73FB2B151J	CHIP R 150 J 1/8W	K2,E2,E4
R855-862			RK73GB2A101J	CHIP R 100 J 1/10W	E3,E5,J	R973			RK73GB2A473J	CHIP R 47K J 1/10W	K2,E2,E4
R855-862			RK73GB2A101J	CHIP R 100 J 1/10W	J1,J2,J3	R974			RK73GB2A474J	CHIP R 470K J 1/10W	K2,E2,E4
R855-862			RK73GB2A101J	CHIP R 100 J 1/10W	K1,K3,E1	VR1			R32-0752-05	TRIMMING POT. (4.7K/8)	
R864			RK73GB2A101J	CHIP R 100 J 1/10W	E3,E5,J	VR2			R32-0767-05	TRIMMING POT. (1.0K/8)	
R864			RK73GB2A101J	CHIP R 100 J 1/10W	J1,J2,J3	VR3			R32-0758-05	TRIMMING POT. (47K/8)	
R864			RK73GB2A101J	CHIP R 100 J 1/10W	K1,K3,E1	VR4			R32-0752-05	TRIMMING POT. (4.7K/8)	
R867-871			RK73FB2B680J	CHIP R 68 J 1/8W	E3,E5,J	VR950			R31-0633-05	VARIABLE RESISTOR	E3,E5,J
R867-871			RK73FB2B680J	CHIP R 68 J 1/8W	J1,J2,J3	VR950			R31-0633-05	VARIABLE RESISTOR	J1,J2,J3
R867-871			RK73FB2B680J	CHIP R 68 J 1/8W	K1,K3,E1	VR950			R31-0633-05	VARIABLE RESISTOR	K1,K3,E1

PARTS LIST

TX-RX 1 UNIT (X57-605X-XX)

Ref. No.	Address	New parts	Parts No.	Description	Destination	Ref. No.	Address	New parts	Parts No.	Description	Destination
VR951			R31-0637-05	VARIABLE RESISTOR	E3,E5,J	D67-69			MA2S111-F	DIODE	
VR951			R31-0637-05	VARIABLE RESISTOR	J1,J2,J3	D70,71			DAP202U	DIODE	
VR951			R31-0637-05	VARIABLE RESISTOR	K1,K3,E1	D73			MA2S111-F	DIODE	
VR952			R31-0634-05	VARIABLE RESISTOR	E3,E5,J	D75			LFB01	DIODE	
VR952			R31-0634-05	VARIABLE RESISTOR	J1,J2,J3	D76-79			HVC350B	VARIABLE CAPACITANCE DIODE	
VR952			R31-0634-05	VARIABLE RESISTOR	K1,K3,E1	D80			DAN235E	DIODE	
K1,2			S51-1428-05	RELAY		D81			HSC277	DIODE	
K3			S51-1420-05	RELAY		D82			RN739D	DIODE	
S1			S62-0412-05	SLIDE SWITCH	E1,E2,E3	D83			DAN202U	DIODE	
S1			S62-0412-05	SLIDE SWITCH	E4,E5	D84			RN739D	DIODE	
S1			S62-0412-05	SLIDE SWITCH	K1,K2,K3	D85			MA2S111-F	DIODE	
S800-842		*	S70-0475-15	TACT SWITCH	E3,E5,J	D87-89			MA2S111-F	DIODE	
S800-842		*	S70-0475-15	TACT SWITCH	J1,J2,J3	D90			DAN235E	DIODE	
S800-842		*	S70-0475-15	TACT SWITCH	K1,K3,E1	D91			HVC350B	VARIABLE CAPACITANCE DIODE	
S950			S70-0461-05	TACT SWITCH	K2,E2,E4	D92-95			DAN202U	DIODE	
S951		*	S70-0475-15	TACT SWITCH	K2,E2,E4	D96			UDZS6.2B	ZENER DIODE	
D1			LFB01	DIODE		D97		*	1SS226-F	DIODE	
D2			DSP-301N	SURGE ABSORBER		D98			LFB01	DIODE	
D3			LFB01	DIODE		D99			DAN202U	DIODE	
D4			RLS245	DIODE		D100			02DZ5.1F-Y	ZENER DIODE	
D5			V08(G)	DIODE		D101		*	MINISMDC05002F	VARISTOR	
D6			RLS245	DIODE		D102			UDZS10B	ZENER DIODE	
D7,8			RN731V	DIODE		D103,104			DAP202U	DIODE	
D9			V08(G)	DIODE		D106			MA2S111-F	DIODE	
D10			LFB01	DIODE		D107			UDZS10B	ZENER DIODE	
D11,12			RN731V	DIODE		D108		*	MA8033L	ZENER DIODE	
D13			LFB01	DIODE		D109,110			DAP202U	DIODE	
D14			RN731V	DIODE		D111			MA2S111-F	DIODE	
D15			LFB01	DIODE		D112-114			02DZ5.1F-Y	ZENER DIODE	
D16			RN731V	DIODE		D115,116			RB751V-40	DIODE	
D17			LFB01	DIODE		D117,118			MA2S111-F	DIODE	
D18			RN731V	DIODE		D119-124		*	RB751V-40	DIODE	
D19			LFB01	DIODE		D130			L204BBB	DIODE	
D20			RN731V	DIODE		D700			1SS355	DIODE	
D21			LFB01	DIODE		D701,702			DAN202U	DIODE	
D22			RN731V	DIODE		D703			HVC350B	VARIABLE CAPACITANCE DIODE	
D23			LFB01	DIODE		D704,705			LFB01	DIODE	
D24			RN731V	DIODE		D706			DAN202U	DIODE	
D25,26			LFB01	DIODE		D707			MA3J742	DIODE	
D27			RN731V	DIODE		D708			MA2S111-F	DIODE	
D28			LFB01	DIODE		D709			UDZS3.9B	ZENER DIODE	
D29			RN731V	DIODE		D711			MA2S111-F	DIODE	
D30			LFB01	DIODE		D712,713			DA221	DIODE	
D31			RN731V	DIODE		D714			MA2S077-F	DIODE	
D32			LFB01	DIODE		D715			HVC350B	VARIABLE CAPACITANCE DIODE	
D33			RN731V	DIODE		D716			MA2S111-F	DIODE	
D34-36			LFB01	DIODE		D717			DAP202U	DIODE	
D38,39			LFB01	DIODE		D719,720			02DZ5.1F-Y	ZENER DIODE	
D40-42			DAN235E	DIODE		D721			MA2J729	DIODE	
D45,46			DAN235E	DIODE		D805-809			1SS355	DIODE	E3,E5,J
D47			HSC277	DIODE		D805-809			1SS355	DIODE	J1,J2,J3
D48			DAN202U	DIODE		D805-809			1SS355	DIODE	K1,K3,E1
D49,50			HSC277	DIODE		D950-952			1SS355	DIODE	
D52,53			HSC277	DIODE		D959			1SS355	DIODE	K2,E2,E4
D55-58			HSC277	DIODE		D960			UDZS6.2B	ZENER DIODE	K2,E2,E4
D60-62			HSC277	DIODE		IC1			TA31136FNG	IC (FM IF)	
D64			HSC277	DIODE		IC2			NJM2904M-ZB	IC (OP AMP)	
D65			DAN202U	DIODE		IC3			TC74HC4053AFT	IC (MIXER)	
D66			RB706F-40	DIODE		IC4			NJM2904M-ZB	IC (OP AMP)	
						IC5			BU2099FV	IC (EXTENDED I/O)	

J : TS-2000S J1 : TS-2000V J2 : TS-2000SX J3 : TS-2000VX

K1 : TS-2000 (K) K2 : TS-B2000 (K) K3 : TS-2000X (K)

E1 : TS-2000 (E) E2 : TS-B2000 (E) E3 : TS-2000 (E2) E4 : TS-B2000 (E2) E5 : TS-2000X (E)

PARTS LIST

TX-RX 1 UNIT (X57-605X-XX)

Ref. No.	Address	New parts	Parts No.	Description	Destination	Ref. No.	Address	New parts	Parts No.	Description	Destination
IC6			TA4101F-F	IC (MIXER)		Q48			2SC4617(R)	TRANSISTOR	
IC7		*	TC4W53FU-F	IC (MULTIPLEXER)		Q49		*	3SK131-A(M)	FET	
IC8			BU4066BCFV	IC (ANALOG SWITCH)		Q51			UMC2N	TRANSISTOR	
IC9			LA4446	IC (AF PA)		Q52			2SC4617(R)	TRANSISTOR	
IC10		*	ADM202EARUZ	IC (LEVEL CONVERTER)		Q53			UMC2N	TRANSISTOR	
IC11			TC74HC4050AFT	IC (BUFFER AMPLIFIER)		Q54			2SC4617(R)	TRANSISTOR	
IC12		*	NJM2902M-ZB	IC (OP AMP)		Q57			DTA114EKA	DIGITAL TRANSISTOR	
IC13			NJM2904M-ZB	IC (OP AMP)		Q58		*	UMW1N	TRANSISTOR	
IC14			M62363FPDF0J	IC (DAC)		Q59			2SC4617(R)	TRANSISTOR	
IC15			M62364FP-F	IC (DAC)		Q60			DTC114EKA	DIGITAL TRANSISTOR	
IC16,17			BU2099FV	IC (EXTENDED I/O)		Q61,62			2SC4617(R)	TRANSISTOR	
IC18		*	NJM5532M-ZB	IC (OP AMP)		Q63		*	UMW1N	TRANSISTOR	
IC19			NJM2904M-ZB	IC (OP AMP)		Q64			2SA1037AK	TRANSISTOR	
IC601-603			AD9835BRUZ	IC (DDS)		Q65			2SB1188(Q,R)	TRANSISTOR	
IC604		*	TC7S04FU-F	IC (INVERTER)		Q66,67			DTC114EKA	DIGITAL TRANSISTOR	
IC605		*	NJM78L08UA-ZB	IC (AVR)		Q69			2SC4617(R)	TRANSISTOR	
IC801		*	30622M8A4C6GPU	IC (CPU)	E3,E5,J	Q70			2SB1132(Q,R)	TRANSISTOR	
IC801		*	30622M8A4C6GPU	IC (CPU)	J1,J2,J3	Q71,72		*	FMG1A	DIGITAL TRANSISTOR	
IC801		*	30622M8A4C6GPU	IC (CPU)	K1,K3,E1	Q73,74			2SC4617(Q)	TRANSISTOR	
Q1			DTC114EKA	DIGITAL TRANSISTOR		Q75			DTC114EKA	DIGITAL TRANSISTOR	
Q2			2SB1188(Q,R)	TRANSISTOR		Q76,77			2SC4617(Q)	TRANSISTOR	
Q3			DTC114EKA	DIGITAL TRANSISTOR		Q78		*	2SK208-F(Y)	FET	
Q4,5			DTA124EKA	DIGITAL TRANSISTOR		Q79			2SC4617(Q)	TRANSISTOR	
Q6			DTA114EKA	DIGITAL TRANSISTOR		Q80			2SB1188(Q,R)	TRANSISTOR	
Q7-10			2SK520(K44)	FET	J,J1,J2	Q81		*	FMG1A	DIGITAL TRANSISTOR	
Q7-10			2SK520(K44)	FET	J3	Q82,83			2SB1188(Q,R)	TRANSISTOR	
Q7-10		*	2SK520-A(K44)	FET	K1,K2,K3	Q84		*	FMG1A	DIGITAL TRANSISTOR	
Q7-10		*	2SK520-A(K44)	FET	E1,E2,E3	Q85,86			2SB1188(Q,R)	TRANSISTOR	
Q11			DTA124EKA	DIGITAL TRANSISTOR	E4,E5	Q87		*	FMG1A	DIGITAL TRANSISTOR	
Q12			2SK2596	FET		Q88,89			2SB1188(Q,R)	TRANSISTOR	
Q13			2SC3357-A	TRANSISTOR		Q90		*	FMG1A	DIGITAL TRANSISTOR	
Q14			2SB1132(Q,R)	TRANSISTOR		Q91			2SB1188(Q,R)	TRANSISTOR	
Q15		*	FMG1A	DIGITAL TRANSISTOR		Q92		*	FMG1A	DIGITAL TRANSISTOR	
Q16,17			DTA124EKA	DIGITAL TRANSISTOR		Q93-95			2SC4617(R)	TRANSISTOR	
Q18		*	3SK131-A(M)	FET		Q96		*	FMG1A	DIGITAL TRANSISTOR	
Q19,20			2SK520(K43)	FET	J,J1,J2	Q97			2SC5566-E	TRANSISTOR	
Q19,20			2SK520(K43)	FET	J3	Q101-112			DTA114EKA	DIGITAL TRANSISTOR	
Q19,20			2SK520(K43)	FET	K1,K2,K3	Q601-606			2SC4617(R)	TRANSISTOR	
Q19,20		*	2SK520-A(K43)	FET	E1,E2,E3	Q607,608			DTC114EKA	DIGITAL TRANSISTOR	
Q19,20			2SK520-A(K43)	FET		Q609			DTC124EKA	DIGITAL TRANSISTOR	
Q19,20		*	2SK520-A(K43)	FET	E4,E5	Q700,701		*	3SK131-A(M)	FET	
Q21		*	FMG1A	DIGITAL TRANSISTOR		Q702,703			DTC114EKA	DIGITAL TRANSISTOR	
Q22			2SC4617(R)	TRANSISTOR		Q704			DTC124EKA	DIGITAL TRANSISTOR	
Q25		*	3SK131-A(M)	FET		Q705			2SK2596	FET	
Q26		*	UMW1N	TRANSISTOR		Q706			2SB1132(Q,R)	TRANSISTOR	
Q27			2SC4617(R)	TRANSISTOR		Q707,708		*	FMG1A	DIGITAL TRANSISTOR	
Q28			2SC4617(Q)	TRANSISTOR		Q709			2SC4617(Q)	TRANSISTOR	
Q29			2SC4617(R)	TRANSISTOR		Q710			2SC4617(S)	TRANSISTOR	
Q30			2SC4617(Q)	TRANSISTOR		Q711			2SC4617(R)	TRANSISTOR	
Q31			DTA114EKA	DIGITAL TRANSISTOR		Q712			DTC124EKA	DIGITAL TRANSISTOR	
Q32			2SC4617(R)	TRANSISTOR		Q713			DTA114EKA	DIGITAL TRANSISTOR	
Q33		*	FMG1A	DIGITAL TRANSISTOR		Q714			DTC124EKA	DIGITAL TRANSISTOR	
Q34			DTA124EKA	DIGITAL TRANSISTOR		Q715			2SC4617(R)	TRANSISTOR	
Q37			UMC2N	TRANSISTOR		Q800			DTC114EE	DIGITAL TRANSISTOR	E3,E5,J
Q38		*	3SK131-A(M)	FET		Q800			DTC114EE	DIGITAL TRANSISTOR	J1,J2,J3
Q40			DTC114EKA	DIGITAL TRANSISTOR		Q800			DTC114EE	DIGITAL TRANSISTOR	K1,K3,E1
Q41,42			2SC4617(R)	TRANSISTOR		Q801			2SA1641(S,T)	TRANSISTOR	E3,E5,J
Q43			2SK2596	FET		Q801			2SA1641(S,T)	TRANSISTOR	J1,J2,J3
Q44,45			3SK293-F	FET		Q801			2SA1641(S,T)	TRANSISTOR	K1,K3,E1
Q46,47		*	3SK131-A(M)	FET		Q802			DTC114EE	DIGITAL TRANSISTOR	E3,E5,J

PARTS LIST

TX-RX 1 UNIT (X57-605X-XX)
TX-RX 2 UNIT (X57-606X-XX)

Ref. No.	Address	New parts	Parts No.	Description	Desti-nation	Ref. No.	Address	New parts	Parts No.	Description	Desti-nation
Q802			DTC114EE	DIGITAL TRANSISTOR	J1,J2,J3	TX-RX 2 UNIT (X57-606X-XX) 0-00 : J,J1,J2,J3					
Q802			DTC114EE	DIGITAL TRANSISTOR	K1,K3,E1	0-11 : K1,K2,K3 2-71 : E1,E2,E3,E4,E5					
Q803			2SC2712-F(Y)	TRANSISTOR	E3,E5,J	C1			CC73GCH1H120J	CHIP C	12PF J
Q803			2SC2712-F(Y)	TRANSISTOR	J1,J2,J3	C2			CC73GCH1H0R5B	CHIP C	0.5PF B
Q803			2SC2712-F(Y)	TRANSISTOR	K1,K3,E1	C3			CC73GCH1H050B	CHIP C	5.0PF B
Q804			DTC114EE	DIGITAL TRANSISTOR	E3,E5,J	C4			CC73GCH1H070B	CHIP C	7.0PF B
Q804			DTC114EE	DIGITAL TRANSISTOR	J1,J2,J3	C5			CK73GB1H102K	CHIP C	1000PF K
Q804			DTC114EE	DIGITAL TRANSISTOR	K1,K3,E1	C6			CC73GCH1H120J	CHIP C	12PF J
Q805			2SA1162-F(Y)	TRANSISTOR	E3,E5,J	C8			CC73GCH1H120J	CHIP C	12PF J
Q805			2SA1162-F(Y)	TRANSISTOR	J1,J2,J3	C8			CC73GCH1H120J	CHIP C	12PF J
Q805			2SA1162-F(Y)	TRANSISTOR	K1,K3,E1	C8			CC73GCH1H120J	CHIP C	12PF J
Q806			DTC114EE	DIGITAL TRANSISTOR	E3,E5,J	C8			CC73GCH1H220J	CHIP C	22PF J
Q806			DTC114EE	DIGITAL TRANSISTOR	J1,J2,J3	C9-13			CK73GB1H102K	CHIP C	1000PF K
Q806			DTC114EE	DIGITAL TRANSISTOR	K1,K3,E1	C14			CK73GB1H471K	CHIP C	470PF K
Q808			DTC114EE	DIGITAL TRANSISTOR	E3,E5,J	C15			CK73GB1H102K	CHIP C	1000PF K
Q808			DTC114EE	DIGITAL TRANSISTOR	J1,J2,J3	C16			CK73GB1H471K	CHIP C	470PF K
Q808			DTC114EE	DIGITAL TRANSISTOR	K1,K3,E1	C18,19			CK73GB1H102K	CHIP C	1000PF K
Q811			DTC114EE	DIGITAL TRANSISTOR	E3,E5,J	C21			CK73GB1H471K	CHIP C	470PF K
Q811			DTC114EE	DIGITAL TRANSISTOR	J1,J2,J3	C22			CC73GCH1H180J	CHIP C	18PF J
Q811			DTC114EE	DIGITAL TRANSISTOR	K1,K3,E1	C22			CK73GB1H102K	CHIP C	1000PF K
Q813			DTC114EE	DIGITAL TRANSISTOR	E3,E5,J	C22			CK73GB1H102K	CHIP C	1000PF K
Q813			DTC114EE	DIGITAL TRANSISTOR	J1,J2,J3	C22			CK73GB1H102K	CHIP C	1000PF K
Q813			DTC114EE	DIGITAL TRANSISTOR	K1,K3,E1	C23,24			CK73GB1H471K	CHIP C	470PF K
Q815			DTC114EE	DIGITAL TRANSISTOR	E3,E5,J	C25,26			CC73GCH1H101J	CHIP C	100PF J
Q815			DTC114EE	DIGITAL TRANSISTOR	J1,J2,J3	C27			CK73GB1H471K	CHIP C	470PF K
Q815			DTC114EE	DIGITAL TRANSISTOR	K1,K3,E1	C28			CK73GB1H102K	CHIP C	1000PF K
Q817			DTC114EE	DIGITAL TRANSISTOR	E3,E5,J	C29			CK73GB1H471K	CHIP C	470PF K
Q817			DTC114EE	DIGITAL TRANSISTOR	J1,J2,J3	C30			CK73GB1C104K	CHIP C	0.10UF K
Q817			DTC114EE	DIGITAL TRANSISTOR	K1,K3,E1	C31,32			CK73GB1H102K	CHIP C	1000PF K
Q819,820			DTC114EE	DIGITAL TRANSISTOR	E3,E5,J	C34			CK73GB1H102K	CHIP C	1000PF K
Q819,820			DTC114EE	DIGITAL TRANSISTOR	J1,J2,J3	C35			CK73GB1H103K	CHIP C	0.010UF K
Q819,820			DTC114EE	DIGITAL TRANSISTOR	K1,K3,E1	C36,37			CK73GB1H102K	CHIP C	1000PF K
Q822			DTC114EE	DIGITAL TRANSISTOR	E3,E5,J	C39			CC73GCH1H330J	CHIP C	33PF J
Q822			DTC114EE	DIGITAL TRANSISTOR	J1,J2,J3	C40			CK73GB1H102K	CHIP C	1000PF K
Q822			DTC114EE	DIGITAL TRANSISTOR	K1,K3,E1	C41		*	CE32BM1V4R7M	CHIP EL	4.7UF 35WV
Q951			2SC4617(R)	TRANSISTOR	K2,E2,E4	C42			CK73GB1H102K	CHIP C	1000PF K
TH1,2			157-502-65001	THERMISTOR		C43			CK73GB1H471K	CHIP C	470PF K
TH3			157-302-65801	THERMISTOR		C44,45			CK73GB1H102K	CHIP C	1000PF K
TH5,6			157-302-65801	THERMISTOR		C46			CK73GB1H471K	CHIP C	470PF K
TH7,8			157-102-65001	THERMISTOR		C47			CC73GCH1H100D	CHIP C	10PF D
TH9			157-502-65001	THERMISTOR		C48			CK73GB1H103K	CHIP C	0.010UF K
S902			W02-1985-05	ENCODER	E3,E5,J	C49-51			CK73GB1H102K	CHIP C	1000PF K
S902			W02-1985-05	ENCODER	J1,J2,J3	C52			CC73GCH1H040B	CHIP C	4.0PF B
S902			W02-1985-05	ENCODER	K1,K3,E1	C53		*	CE32BM1V4R7M	CHIP EL	4.7UF 35WV
S903		*	W02-1988-15	ENCODER	E3,E5,J	C54			CK73GB1H102K	CHIP C	1000PF K
S903		*	W02-1988-15	ENCODER	J1,J2,J3	C55			CK73GB1H471K	CHIP C	470PF K
S903		*	W02-1988-15	ENCODER	K1,K3,E1	C56			CK73GB1H102K	CHIP C	1000PF K
S904		*	W02-1989-15	ENCODER	E3,E5,J	C57			CK73GB1H471K	CHIP C	470PF K
S904		*	W02-1989-15	ENCODER	J1,J2,J3	C58,59			CK73GB1H102K	CHIP C	1000PF K
S904		*	W02-1989-15	ENCODER	K1,K3,E1	C60,61			CK73GB1H471K	CHIP C	470PF K
						C62			CK73GB1H102K	CHIP C	1000PF K
						C63			CC73GCH1H080B	CHIP C	8.0PF B
						C64			CK73GB1H102K	CHIP C	1000PF K
						C65			CC73GCH1H390J	CHIP C	39PF J
						C66			CC73GCH1H010B	CHIP C	1.0PF B
						C67			CC73GCH1H100D	CHIP C	10PF D
						C68			CK73GB1H471K	CHIP C	470PF K
						C69			CC73GCH1H080B	CHIP C	8.0PF B
						C70			CC73GCH1H120J	CHIP C	12PF J

J : TS-2000S J1 : TS-2000V J2 : TS-2000SX J3 : TS-2000VX
K1 : TS-2000 (K) K2 : TS-B2000 (K) K3 : TS-2000X (K)
E1 : TS-2000 (E) E2 : TS-B2000 (E) E3 : TS-2000 (E2) E4 : TS-B2000 (E2) E5 : TS-2000X (E)

PARTS LIST

TX-RX 2 UNIT (X57-606X-XX)

Ref. No.	Address	New parts	Parts No.	Description	Destination	Ref. No.	Address	New parts	Parts No.	Description	Destination
C71			CK73GB1H102K	CHIP C 1000PF K		C146			CC73GCH1H101J	CHIP C 100PF J	
C73			CK73GB1H103K	CHIP C 0.010UF K		C147			CC73GCH1H080B	CHIP C 8.0PF B	
C74,75			CK73GB1H102K	CHIP C 1000PF K		C148			CC73GCH1H050B	CHIP C 5.0PF B	
C76			CC73GCH1H070B	CHIP C 7.0PF B		C150			CC73GCH1H0R5B	CHIP C 0.5PF B	
C77			CC73GCH1H0R3B	CHIP C 0.3PF B		C151			CC73GCH1H150J	CHIP C 15PF J	
C78			CK73GB1H471K	CHIP C 470PF K		C152			CK73GB1H471K	CHIP C 470PF K	
C79			CC73GCH1H050B	CHIP C 5.0PF B		C153			CC73GCH1H101J	CHIP C 100PF J	
C80			CK73GB1H102K	CHIP C 1000PF K		C154			CK73GB1H102K	CHIP C 1000PF K	
C81			CK73GB1H471K	CHIP C 470PF K		C155			CC73GCH1H040B	CHIP C 4.0PF B	
C82			CK73GB1H102K	CHIP C 1000PF K		C156			CK73GB1H102K	CHIP C 1000PF K	
C83			CC73GCH1H040B	CHIP C 4.0PF B		C157			CC73GCH1H040B	CHIP C 4.0PF B	
C84			CC73GCH1H150J	CHIP C 15PF J		C158			CC73GCH1H060B	CHIP C 6.0PF B	
C85			CK73GB1H102K	CHIP C 1000PF K		C159			CK73GB1H102K	CHIP C 1000PF K	
C86			CK73GB1H471K	CHIP C 470PF K		C160			CC73GCH1H040B	CHIP C 4.0PF B	
C88			CK73GB1H102K	CHIP C 1000PF K		C161			CK73GB1H471K	CHIP C 470PF K	
C91			CC73GCH1H060B	CHIP C 6.0PF B		C162,163			CC73GCH1H050B	CHIP C 5.0PF B	
C92			CC73GCH1H070B	CHIP C 7.0PF B		C164			CC73GCH1H0R5B	CHIP C 0.5PF B	
C94			CK73GB1H102K	CHIP C 1000PF K		C165			CC73GCH1H020B	CHIP C 2.0PF B	
C95			CC73GCH1H030B	CHIP C 3.0PF B		C166			CC73GCH1H070B	CHIP C 7.0PF B	
C96			CK73GB1H471K	CHIP C 470PF K		C167			CK73GB1H471K	CHIP C 470PF K	
C97			CC73GCH1H0R5B	CHIP C 0.5PF B		C168			CC73GCH1H040B	CHIP C 4.0PF B	
C98			CC73GCH1H040B	CHIP C 4.0PF B		C169			CK73GB1H102K	CHIP C 1000PF K	
C99			CC73GCH1H0R5B	CHIP C 0.5PF B		C170			CC73GCH1H060B	CHIP C 6.0PF B	
C100			CC73GCH1H040B	CHIP C 4.0PF B		C171			CC73GCH1H120J	CHIP C 12PF J	
C101			CK73GB1H471K	CHIP C 470PF K		C172			CC73GCH1H0R3B	CHIP C 0.3PF B	
C102			CC73GCH1H0R5B	CHIP C 0.5PF B		C173			CC73GCH1H030B	CHIP C 3.0PF B	
C103			CC73GCH1H0R3B	CHIP C 0.3PF B		C174,175			CK73GB1H102K	CHIP C 1000PF K	
C104			CC73GCH1H050B	CHIP C 5.0PF B		C176			CK73GB1H471K	CHIP C 470PF K	
C105,106			CK73GB1H102K	CHIP C 1000PF K		C177			CC73GCH1H470J	CHIP C 47PF J	
C107			CC73GCH1H050B	CHIP C 5.0PF B		C178			CC73GCH1H0R3B	CHIP C 0.3PF B	
C108			CC73GCH1H270J	CHIP C 27PF J		C179			CC73GCH1H150J	CHIP C 15PF J	
C109			CC73GCH1H070B	CHIP C 7.0PF B		C180			CK73GB1H102K	CHIP C 1000PF K	
C110			CK73GB1H103K	CHIP C 0.010UF K		C181			CC73GCH1H050B	CHIP C 5.0PF B	
C111			CC73GCH1H050B	CHIP C 5.0PF B		C182			CC73GCH1H090B	CHIP C 9.0PF B	
C112			CC73GCH1H100D	CHIP C 10PF D		C183			CK73GB1H102K	CHIP C 1000PF K	
C113			CK73GB1H102K	CHIP C 1000PF K		C184			CK73GB1H471K	CHIP C 470PF K	
C114			CK73GB1H471K	CHIP C 470PF K		C185			CC73GCH1H050B	CHIP C 5.0PF B	
C115			CC73GCH1H180J	CHIP C 18PF J		C186			CC73GCH1H0R3B	CHIP C 0.3PF B	
C116			CC73GCH1H0R3B	CHIP C 0.3PF B		C187			CK73GB1H103K	CHIP C 0.010UF K	
C117,118			CK73GB1H102K	CHIP C 1000PF K		C188			CC73GCH1H100D	CHIP C 10PF D	
C119			CC73GCH1H180J	CHIP C 18PF J		C189			CC73GCH1H0R3B	CHIP C 0.3PF B	
C120			CK73GB1H102K	CHIP C 1000PF K		C190			CC73GCH1H100D	CHIP C 10PF D	
C123			CK73GB1H102K	CHIP C 1000PF K		C191			CK73FB1C105K	CHIP C 1.0UF K	
C124			CC73GCH1H120J	CHIP C 12PF J		C192			CC73GCH1H040B	CHIP C 4.0PF B	
C125			CC73GCH1H060B	CHIP C 6.0PF B		C193,194			CK73GB1H102K	CHIP C 1000PF K	
C126			CK73GB1H102K	CHIP C 1000PF K		C195			CK73GB1H103K	CHIP C 0.010UF K	
C127			CK73GB1H471K	CHIP C 470PF K		C196-199			CK73GB1H102K	CHIP C 1000PF K	
C128			CC73GCH1H020B	CHIP C 2.0PF B		C200,201			CK73GB1H471K	CHIP C 470PF K	
C129			CK73GB1H471K	CHIP C 470PF K		C202,203			CC73GCH1H040B	CHIP C 4.0PF B	
C130			CK73GB1H102K	CHIP C 1000PF K		C204			CC73GCH1H2R5B	CHIP C 2.5PF B	
C131-133			CK73GB1H471K	CHIP C 470PF K		C205			CK73GB1H471K	CHIP C 470PF K	
C134			CC73GCH1H050B	CHIP C 5.0PF B		C206,207			CK73GB1H102K	CHIP C 1000PF K	
C135			CC73GCH1H060B	CHIP C 6.0PF B		C208,209			CK73GB1H471K	CHIP C 470PF K	
C136,137			CK73GB1H102K	CHIP C 1000PF K		C210			CK73FB1C105K	CHIP C 1.0UF K	
C138			CK73GB1H471K	CHIP C 470PF K		C211			CK73GB1H471K	CHIP C 470PF K	
C139,140			CK73GB1H102K	CHIP C 1000PF K		C212			CK73GB1H102K	CHIP C 1000PF K	
C141			CK73GB1H471K	CHIP C 470PF K		C213			CK73GB1C104K	CHIP C 0.10UF K	
C142			CC73GCH1H040B	CHIP C 4.0PF B		C214-219			CK73GB1H102K	CHIP C 1000PF K	
C143,144			CK73GB1H102K	CHIP C 1000PF K		C220-222			CK73GB1C104K	CHIP C 0.10UF K	
C145			CK73GB1H471K	CHIP C 470PF K		C224			CC73GCH1H100D	CHIP C 10PF D	

PARTS LIST

TX-RX 2 UNIT (X57-606X-XX)

Ref. No.	Address	New parts	Parts No.	Description	Desti-nation	Ref. No.	Address	New parts	Parts No.	Description	Desti-nation
C225			CK73GB1C104K	CHIP C 0.10UF K		C301			CK73GB1H103K	CHIP C 0.010UF K	
C227			CC73GCH1H020B	CHIP C 2.0PF B		C303			CK73GB1C104K	CHIP C 0.10UF K	
C232			CK73GB1H102K	CHIP C 1000PF K		C304-307			CK73GB1H103K	CHIP C 0.010UF K	
C233			CC73GCH1H220J	CHIP C 22PF J		C308,309			CK73GB1C104K	CHIP C 0.10UF K	E1,E2,E3
C234			CC73GCH1H270J	CHIP C 27PF J		C308,309			CK73GB1C104K	CHIP C 0.10UF K	E4,E5
C235			CK73GB1H102K	CHIP C 1000PF K		C309			CK73GB1C104K	CHIP C 0.10UF K	J,J1,J2
C238			CK73GB1H102K	CHIP C 1000PF K		C309			CK73GB1C104K	CHIP C 0.10UF K	J3
C239			CK73GB1H471K	CHIP C 470PF K		C309			CK73GB1C104K	CHIP C 0.10UF K	K1,K2,K3
C240			CC73GCH1H050B	CHIP C 5.0PF B		C310			CK73GB1H103K	CHIP C 0.010UF K	
C241			CC73GCH1H120J	CHIP C 12PF J		C312			CK73GB1C104K	CHIP C 0.10UF K	
C242,243			CK73GB1H102K	CHIP C 1000PF K		C314,315			CK73GB1H103K	CHIP C 0.010UF K	
C245			CK73GB1H102K	CHIP C 1000PF K		C316			CC73GCH1H120J	CHIP C 12PF J	
C246			CC73GCH1H030B	CHIP C 3.0PF B		C317,318			CK73GB1H103K	CHIP C 0.010UF K	
C247			CK73GB1H471K	CHIP C 470PF K		C319			CC73GCH1H240J	CHIP C 24PF J	
C248			CC73GCH1H150J	CHIP C 15PF J		C320			CK73GB1H103K	CHIP C 0.010UF K	
C249			CC73GCH1H050B	CHIP C 5.0PF B	E1,E2,E3	C321			CC73GCH1H240J	CHIP C 24PF J	
C249			CC73GCH1H050B	CHIP C 5.0PF B	E4,E5,J	C322			CK73GB1H103K	CHIP C 0.010UF K	
C249			CC73GCH1H050B	CHIP C 5.0PF B	J1,J2,J3	C323			CE32BM1E470M	CHIP EL 47UF 25WV	
C249			CC73GCH1H100D	CHIP C 10PF D	K1,K2,K3	C324			CK73GB1H103K	CHIP C 0.010UF K	
C250			CK73GB1H471K	CHIP C 470PF K		C325			CK73GB1C104K	CHIP C 0.10UF K	
C251			CK73GB1C104K	CHIP C 0.10UF K		C326,327			CC73GCH1H030B	CHIP C 3.0PF B	
C252			CC73GCH1H070B	CHIP C 7.0PF B		C328			CK73GB1C104K	CHIP C 0.10UF K	
C253			CK73GB1H103K	CHIP C 0.010UF K		C329,330			CK73GB1H103K	CHIP C 0.010UF K	
C254			CC73GCH1H030B	CHIP C 3.0PF B		C331			CK73GB1C104K	CHIP C 0.10UF K	
C255			CK73GB1H103K	CHIP C 0.010UF K		C332			CK73GB1H102K	CHIP C 1000PF K	
C256			CC73GCH1H120J	CHIP C 12PF J		C333			CK73GB1H103K	CHIP C 0.010UF K	
C257			CK73GB1H102K	CHIP C 1000PF K		C334			CK73GB1C104K	CHIP C 0.10UF K	
C258			CK73GB1H103K	CHIP C 0.010UF K		C335			CC73GCH1H270J	CHIP C 27PF J	
C259			CK73GB1H102K	CHIP C 1000PF K		C336			CK73GB1C104K	CHIP C 0.10UF K	
C260			CK73GB1H103K	CHIP C 0.010UF K		C338			CC73GCH1H221J	CHIP C 220PF J	
C261			CK73GB1H102K	CHIP C 1000PF K		C339			CK73GB1H103K	CHIP C 0.010UF K	
C262,263			CK73GB1H103K	CHIP C 0.010UF K		C340			CC73GCH1H221J	CHIP C 220PF J	
C264,265			CK73GB1H102K	CHIP C 1000PF K		C341			CK73GB1H471K	CHIP C 470PF K	
C266			CK73GB1H103K	CHIP C 0.010UF K		C342,343			CK73GB1C104K	CHIP C 0.10UF K	
C267			CK73GB1C104K	CHIP C 0.10UF K		C345			CK73GB1H103K	CHIP C 0.010UF K	
C268			CC73GCH1H390J	CHIP C 39PF J		C346			CK73GB1C473K	CHIP C 0.047UF K	
C269			CK73GB1H103K	CHIP C 0.010UF K		C347			CK73GB1H472K	CHIP C 4700PF K	
C270			CK73GB1H102K	CHIP C 1000PF K		C348			CC73GCH1H331J	CHIP C 330PF J	
C271			CC73GCH1H150J	CHIP C 15PF J		C349			CK73GB1C104K	CHIP C 0.10UF K	
C272			CK73GB1H102K	CHIP C 1000PF K		C350			CK73GB1H103K	CHIP C 0.010UF K	
C274			CK73GB1H471K	CHIP C 470PF K		C352			CK73GB1C473K	CHIP C 0.047UF K	
C276			CK73GB1H471K	CHIP C 470PF K		C353			CK73GB1H103K	CHIP C 0.010UF K	
C277			CC73GCH1H150J	CHIP C 15PF J		C357			CK73GB1E223K	CHIP C 0.022UF K	
C278			CK73GB1H103K	CHIP C 0.010UF K		C358			CK73GB1C473K	CHIP C 0.047UF K	
C279			CC73GCH1H010B	CHIP C 1.0PF B		C359			CK73GB1H103K	CHIP C 0.010UF K	
C280			CK73FB1C105K	CHIP C 1.0UF K		C360			CK73GB1C104K	CHIP C 0.10UF K	
C281			CK73GB1C104K	CHIP C 0.10UF K		C361			CC73GCH1H180J	CHIP C 18PF J	E1,E2,E3
C282			CC73GCH1H200J	CHIP C 20PF J		C361			CC73GCH1H180J	CHIP C 18PF J	E4,E5,J
C283			CC73GCH1H030B	CHIP C 3.0PF B		C361			CC73GCH1H180J	CHIP C 18PF J	J1,J2,J3
C284-287			CK73GB1H103K	CHIP C 0.010UF K		C361			CC73GCH1H270J	CHIP C 27PF J	K1,K2,K3
C288			CK73GB1H102K	CHIP C 1000PF K		C362			CK73FB1C105K	CHIP C 1.0UF K	
C289			CK73GB1C104K	CHIP C 0.10UF K	E1,E2,E3	C363			CE32BM1E470M	CHIP EL 47UF 25WV	
C289			CK73GB1C104K	CHIP C 0.10UF K	E4,E5	C364,365			CK73FB1C105K	CHIP C 1.0UF K	
C290-292			CK73GB1H103K	CHIP C 0.010UF K		C366			CK73GB1H103K	CHIP C 0.010UF K	
C293,294			CK73FB1C105K	CHIP C 1.0UF K		C368			CS77AA1A100M	CHIP TNTL 10UF 10WV	
C295			CK73GB1H103K	CHIP C 0.010UF K		C372-375			CK73GB1H102K	CHIP C 1000PF K	
C296			CC73GCH1H060B	CHIP C 6.0PF B		C376			CC73GCH1H060B	CHIP C 6.0PF B	
C297,298			CK73GB1H103K	CHIP C 0.010UF K		C377,378			CC73GCH1H150J	CHIP C 15PF J	
C299			CK73GB1H471K	CHIP C 470PF K		C379			CC73GCH1H050B	CHIP C 5.0PF B	
C300			CK73GB1H102K	CHIP C 1000PF K		C382			CC73GCH1H050B	CHIP C 5.0PF B	

J : TS-2000S J1 : TS-2000V J2 : TS-2000SX J3 : TS-2000VX

K1 : TS-2000 (K) K2 : TS-B2000 (K) K3 : TS-2000X (K)

E1 : TS-2000 (E) E2 : TS-B2000 (E) E3 : TS-2000 (E2) E4 : TS-B2000 (E2) E5 : TS-2000X (E)

PARTS LIST

TX-RX 2 UNIT (X57-606X-XX)

Ref. No.	Address	New parts	Parts No.	Description	Destination	Ref. No.	Address	New parts	Parts No.	Description	Destination
C383			CK73GB1H102K	CHIP C 1000PF K		C483			CK73GB1H103K	CHIP C 0.010UF K	
C385			CC73GCH1H010B	CHIP C 1.0PF B		C484			CK73GB1H102K	CHIP C 1000PF K	
C386			CC73GCH1H050B	CHIP C 5.0PF B		C485			CS77AA1A100M	CHIP TNTL 10UF 10WV	
C387			CC73GCH1H180J	CHIP C 18PF J	K1,K2,K3	C486,487			CC73GCH1H060B	CHIP C 6.0PF B	
C387			CC73GCH1H470J	CHIP C 47PF J	E1,E2,E3	C488			CC73GCH1H390J	CHIP C 39PF J	
C387			CC73GCH1H470J	CHIP C 47PF J	E4,E5,J	C489			CK73GB1H103K	CHIP C 0.010UF K	
C387			CC73GCH1H470J	CHIP C 47PF J	J1,J2,J3	C490			CK73GB1H472K	CHIP C 4700PF K	
C389,390			CK73GB1C104K	CHIP C 0.10UF K		C491,492			CC73GCH1H050B	CHIP C 5.0PF B	
C391			CS77AA1A100M	CHIP TNTL 10UF 10WV		C494			CK73GB1H103K	CHIP C 0.010UF K	
C393-399			CK73GB1H102K	CHIP C 1000PF K		C495			CC73GCH1H470J	CHIP C 47PF J	
C401			CK73GB1H102K	CHIP C 1000PF K		C496			CK73GB1H102K	CHIP C 1000PF K	
C415			CC73GCH1H010B	CHIP C 1.0PF B		C497			CC73GCH1H060B	CHIP C 6.0PF B	
C420			CK73GB1H472K	CHIP C 4700PF K		C498			CK73GB1H102K	CHIP C 1000PF K	
C421			CS77AA1A100M	CHIP TNTL 10UF 10WV		C499			CC73GCH1H060B	CHIP C 6.0PF B	
C422			CS77CA1A3R3M	CHIP TNTL 3.3UF 10WV		C501			CK73GB1H471K	CHIP C 470PF K	
C423,424			CK73GB1H102K	CHIP C 1000PF K		C502			CS77AA1A100M	CHIP TNTL 10UF 10WV	
C425			CS77AA1A100M	CHIP TNTL 10UF 10WV		C503			CK73GB1H472K	CHIP C 4700PF K	
C427			CC73GCH1H180J	CHIP C 18PF J		C504			CK73GB1C473K	CHIP C 0.047UF K	
C428			CC73GCH1H100D	CHIP C 10PF D		C505			CC73GCH1H270J	CHIP C 27PF J	
C429			CK73GB1H102K	CHIP C 1000PF K		C506			CC73GCH1H040B	CHIP C 4.0PF B	
C431			CK73GB1H102K	CHIP C 1000PF K		C507			CK73GB1H103K	CHIP C 0.010UF K	
C432			CS77CA1A3R3M	CHIP TNTL 3.3UF 10WV		C508			CC73GCH1H470J	CHIP C 47PF J	
C433			CK73GB1H471K	CHIP C 470PF K		C509			CK73GB1H471K	CHIP C 470PF K	
C434			CC73GCH1H080B	CHIP C 8.0PF B		C510			CC73GCH1H101J	CHIP C 100PF J	
C435			CK73GB1H102K	CHIP C 1000PF K		C511			CK73GB1H471K	CHIP C 470PF K	
C436			CK73GB1H471K	CHIP C 470PF K		C512			CC73GCH1H390J	CHIP C 39PF J	
C437			CC73GCH1H060B	CHIP C 6.0PF B		C513			CS77CA1V0R1M	CHIP TNTL 0.1UF 35WV	
C438			CK73GB1H102K	CHIP C 1000PF K		C514			CS77CA1C010M	CHIP TNTL 1.0UF 16WV	
C439			CK73GB1C473K	CHIP C 0.047UF K		C515			CC73GCH1H101J	CHIP C 100PF J	
C440			CK73GB1H102K	CHIP C 1000PF K		C516			CS77CA1ER47M	CHIP TNTL 0.47UF 25WV	
C441			CK73GB1C473K	CHIP C 0.047UF K		C517			CC73GCH1H151J	CHIP C 150PF J	
C442			CS77AA1C100M	CHIP TNTL 10UF 16WV		C518			C92-0863-05	CHIP TNTL 0.047UF 35WV	
C443			CC73GCH1H050B	CHIP C 5.0PF B		C519			CK73GB1C473K	CHIP C 0.047UF K	
C444			CK73GB1C473K	CHIP C 0.047UF K		C520			CC73GCH1H151J	CHIP C 150PF J	
C445			CC73GCH1H030B	CHIP C 3.0PF B		C521			CK73GB1C473K	CHIP C 0.047UF K	
C446			CC73GCH1H1R5B	CHIP C 1.5PF B		C522			CC73GCH1H151J	CHIP C 150PF J	
C447			CK73GB1H103K	CHIP C 0.010UF K		C523			CK73GB1H472K	CHIP C 4700PF K	
C448,449			CK73GB1H102K	CHIP C 1000PF K		C524			CC73GCH1H470J	CHIP C 47PF J	
C453			CC73GCH1H070B	CHIP C 7.0PF B		C525			CC73GCH1H100D	CHIP C 100PF D	
C454			CC73GCH1H150J	CHIP C 15PF J		C526			CK73GB1H102K	CHIP C 1000PF K	
C455			CK73GB1H103K	CHIP C 0.010UF K		C527			CK73GB1C473K	CHIP C 0.047UF K	
C456			CC73GCH1H180J	CHIP C 18PF J		C528			CS77AA1A100M	CHIP TNTL 10UF 10WV	
C457			CC73GCH1H080B	CHIP C 8.0PF B		C529			CK73GB1H472K	CHIP C 4700PF K	
C458			CC73GCH1H070B	CHIP C 7.0PF B		C530			CC73GCH1H070B	CHIP C 7.0PF B	
C459,460			CK73GB1H102K	CHIP C 1000PF K		C531			CK73GB1C473K	CHIP C 0.047UF K	
C461			CK73GB1H472K	CHIP C 4700PF K		C532			CC73GCH1H270J	CHIP C 27PF J	
C462,463			CC73GCH1H180J	CHIP C 18PF J		C533			CC73GCH1H101J	CHIP C 100PF J	
C464			CK73GB1C473K	CHIP C 0.047UF K		C534	*		CS77AC1A101M	CHIP TNTL 100UF 10WV	
C465,466			CK73GB1H102K	CHIP C 1000PF K		C535			CC73GCH1H820J	CHIP C 82PF J	
C467,468			CK73GB1H103K	CHIP C 0.010UF K		C536			CK73GB1C473K	CHIP C 0.047UF K	
C468			CK73GB1H103K	CHIP C 0.010UF K		C537			CC73GCH1H020B	CHIP C 2.0PF B	
C469,470			CC73GCH1H0R5B	CHIP C 0.5PF B		C538			CK73GB1C473K	CHIP C 0.047UF K	
C471			CS77AA1A100M	CHIP TNTL 10UF 10WV		C539			CS77AA1A100M	CHIP TNTL 10UF 10WV	
C472			CC73GCH1H220J	CHIP C 22PF J		C540			CC73GCH1H150J	CHIP C 15PF J	
C473			CS77AA1A100M	CHIP TNTL 10UF 10WV		C541			CK73GB1C473K	CHIP C 0.047UF K	
C474			CK73GB1H471K	CHIP C 470PF K		C542			CC73GCH1H101J	CHIP C 100PF J	
C475,476			CK73GB1H102K	CHIP C 1000PF K		C543			CC73GCH1H080B	CHIP C 8.0PF B	
C477			CK73GB1H103K	CHIP C 0.010UF K		C544			CK73GB1H472K	CHIP C 4700PF K	
C478,479			CK73GB1H471K	CHIP C 470PF K		C545			CK73GB1H102K	CHIP C 1000PF K	
C481,482			CC73GCH1H040B	CHIP C 4.0PF B		C546	*		CS77AC1A101M	CHIP TNTL 100UF 10WV	

PARTS LIST

TX-RX 2 UNIT (X57-606X-XX)

Ref. No.	Address	New parts	Parts No.	Description	Desti-nation	Ref. No.	Address	New parts	Parts No.	Description	Desti-nation
C547			CC73GCH1H470J	CHIP C 47PF J		C628			CC73GCH1H040B	CHIP C 4.0PF B	
C548			CC73GCH1H010B	CHIP C 1.0PF B		C629			CC73GCH1H101J	CHIP C 100PF J	
C549			CC73GCH1H390J	CHIP C 39PF J		C630			CC73GCH1H820J	CHIP C 82PF J	
C550			CK73GB1H102K	CHIP C 1000PF K		C631			CC73GCH1H240J	CHIP C 24PF J	
C551			CC73GCH1H121J	CHIP C 120PF J		C632,633			CC73GCH1H030B	CHIP C 3.0PF B	
C552			CK73GB1H102K	CHIP C 1000PF K		C634			CC73GCH1H470J	CHIP C 47PF J	
C554			CK73GB1H103K	CHIP C 0.010UF K		C636			CC73GCH1H390J	CHIP C 39PF J	
C555			CC73GCH1H070B	CHIP C 7.0PF B		C637			CK73GB1C473K	CHIP C 0.047UF K	
C556			CC73GCH1H181J	CHIP C 180PF J		C638			CC73GCH1H070B	CHIP C 7.0PF B	
C558			CK73GB1H103K	CHIP C 0.010UF K		C639			CK73GB1C473K	CHIP C 0.047UF K	
C559,560			CK73GB1C473K	CHIP C 0.047UF K		C640			CC73GCH1H101J	CHIP C 100PF J	
C561			CC73GCH1H150J	CHIP C 15PF J		C641			CC73GCH1H560J	CHIP C 56PF J	
C562			CC73GCH1H470J	CHIP C 47PF J		C642			CK73GB1C473K	CHIP C 0.047UF K	
C563			CC73GCH1H151J	CHIP C 150PF J		C643			CC73GCH1H560J	CHIP C 56PF J	
C564			CC73GCH1H101J	CHIP C 100PF J		C644			CC73GCH1H820J	CHIP C 82PF J	
C565			CK73GB1H103K	CHIP C 0.010UF K		C645			CK73GB1C473K	CHIP C 0.047UF K	
C566			CC73GCH1H101J	CHIP C 100PF J		C646			CK73GB1H102K	CHIP C 1000PF K	
C567			CK73GB1H103K	CHIP C 0.010UF K		C647			CC73GCH1H120J	CHIP C 12PF J	
C568			CK73GB1H472K	CHIP C 4700PF K		C648			CK73GB1H102K	CHIP C 1000PF K	
C569			CC73GCH1H470J	CHIP C 47PF J		C649			CK73GB1C473K	CHIP C 0.047UF K	
C570			CC73GCH1H151J	CHIP C 150PF J		C650			CC73GCH1H100D	CHIP C 10PF D	
C571			CK73GB1H332K	CHIP C 3300PF K		C651			CC73GCH1H101J	CHIP C 100PF J	
C572,573			CK73GB1C473K	CHIP C 0.047UF K		C652			CC73GCH1H060B	CHIP C 6.0PF B	
C574			CS77AA1A100M	CHIP TNTL 10UF 10WV		C654			CC73GCH1H030B	CHIP C 3.0PF B	
C576			CK73GB1H472K	CHIP C 4700PF K		C656			CK73GB1H471K	CHIP C 470PF K	
C577			CS77AA1A100M	CHIP TNTL 10UF 10WV		C657			CC73GCH1H080B	CHIP C 8.0PF B	
C579			CK73GB1H472K	CHIP C 4700PF K		C658			CC73GCH1H0R5B	CHIP C 0.5PF B	
C580			CK73GB1C473K	CHIP C 0.047UF K		C659			CC73GCH1H560J	CHIP C 56PF J	
C581			CC73GCH1H220J	CHIP C 22PF J		C660			CK73GB1H332K	CHIP C 3300PF K	
C582			CC73GCH1H181J	CHIP C 180PF J		C662			CK73GB1H472K	CHIP C 4700PF K	
C583			CS77AA1A100M	CHIP TNTL 10UF 10WV		C663			CC73GCH1H120J	CHIP C 12PF J	
C585			CK73GB1H472K	CHIP C 4700PF K		C665			CK73GB1C473K	CHIP C 0.047UF K	
C586-588			CK73GB1H103K	CHIP C 0.010UF K		C666			CK73GB1H472K	CHIP C 4700PF K	
C588			CK73GB1H103K	CHIP C 0.010UF K		C667,668			CK73GB1C473K	CHIP C 0.047UF K	
C589,590			CK73GB1H102K	CHIP C 1000PF K		C669			CK73GB1H102K	CHIP C 1000PF K	
C591			CC73GCH1H390J	CHIP C 39PF J		C670			CC73GCH1H0R5B	CHIP C 0.5PF B	
C592			CC73GCH1H270J	CHIP C 27PF J		C671			CC73GCH1H560J	CHIP C 56PF J	
C593-595			CK73GB1H103K	CHIP C 0.010UF K		C672			CK73GB1H102K	CHIP C 1000PF K	
C596,597			CS77AA1A100M	CHIP TNTL 10UF 10WV		C674			CC73GCH1H101J	CHIP C 100PF J	
C598,599			CK73GB1C473K	CHIP C 0.047UF K		C675			CK73GB1H471K	CHIP C 470PF K	
C600			CK73GB1H102K	CHIP C 1000PF K		C676			CK73GB1C473K	CHIP C 0.047UF K	
C601			CC73GCH1H020B	CHIP C 2.0PF B		C677			CC73GCH1H151J	CHIP C 150PF J	
C602		*	CS77AC1A101M	CHIP TNTL 100UF 10WV		C679			CK73GB1C473K	CHIP C 0.047UF K	
C603			CK73GB1C473K	CHIP C 0.047UF K		C680			CK73GB1H102K	CHIP C 1000PF K	
C605,606			CK73GB1C473K	CHIP C 0.047UF K		C681			CC73GCH1H070B	CHIP C 7.0PF B	
C606			CK73GB1C473K	CHIP C 0.047UF K		C682			CK73GB1H471K	CHIP C 470PF K	
C607,608			CC73GCH1H560J	CHIP C 56PF J		C683			CK73GB1H102K	CHIP C 1000PF K	
C609			CC73GCH1H150J	CHIP C 15PF J		C684			CK73GB1H471K	CHIP C 470PF K	
C610,611			CC73GCH1H240J	CHIP C 24PF J		C685			CC73GCH1H020B	CHIP C 2.0PF B	
C612			CK73GB1H103K	CHIP C 0.010UF K		C686			C93-0787-05	CHIP C 0.10UF J	
C613			CC73GCH1H101J	CHIP C 100PF J		C687			CK73GB1H102K	CHIP C 1000PF K	
C614			CC73GCH1H100D	CHIP C 10PF D		C688			CC73GCH1H150J	CHIP C 15PF J	
C615			CC73GCH1H101J	CHIP C 100PF J		C689			CK73GB1H102K	CHIP C 1000PF K	
C616,617			CK73GB1C473K	CHIP C 0.047UF K		C690			CC73GCH1H070B	CHIP C 7.0PF B	
C618,619			CC73GCH1H100D	CHIP C 10PF D		C691			CK73GB1H103K	CHIP C 0.010UF K	
C620			CS77AA1A100M	CHIP TNTL 10UF 10WV		C693,694			CK73GB1H472K	CHIP C 4700PF K	
C621-623			CK73GB1C473K	CHIP C 0.047UF K		C694			CK73GB1H472K	CHIP C 4700PF K	
C625			CK73GB1C473K	CHIP C 0.047UF K		C695			CC73GCH1H060B	CHIP C 6.0PF B	
C626			CC73GCH1H560J	CHIP C 56PF J		C696			CK73GB1H102K	CHIP C 1000PF K	
C627			CC73GCH1H101J	CHIP C 100PF J		C698,699			CS77AA1A100M	CHIP TNTL 10UF 10WV	

J : TS-2000S J1 : TS-2000V J2 : TS-2000SX J3 : TS-2000VX

K1 : TS-2000 (K) K2 : TS-B2000 (K) K3 : TS-2000X (K)

E1 : TS-2000 (E) E2 : TS-B2000 (E) E3 : TS-2000 (E2) E4 : TS-B2000 (E2) E5 : TS-2000X (E)

PARTS LIST

TX-RX 2 UNIT (X57-606X-XX)

Ref. No.	Address	New parts	Parts No.	Description	Destination	Ref. No.	Address	New parts	Parts No.	Description	Destination
C700			CC73GCH1H150J	CHIP C 15PF J		C784			CK73GB1H102K	CHIP C 1000PF K	
C701			CC73GCH1H270J	CHIP C 27PF J		C786			CK73GB1H103K	CHIP C 0.010UF K	
C702			CC73GCH1H180J	CHIP C 18PF J		C788			CK73GB1H103K	CHIP C 0.010UF K	
C705			CK73GB1H102K	CHIP C 1000PF K		C789,790			CC73GCH1H101J	CHIP C 100PF J	
C706			CK73GB1H103K	CHIP C 0.010UF K		C791			CK73GB1H103K	CHIP C 0.010UF K	
C707			CK73GB1H102K	CHIP C 1000PF K		C792			CK73GB1H471K	CHIP C 470PF K	
C708,709			CK73GB1C473K	CHIP C 0.047UF K		C793			CS77AA1A4R7M	CHIP TNTL 4.7UF 10WV	
C712			CC73GCH1H020B	CHIP C 2.0PF B		C794			CK73GB1H472K	CHIP C 4700PF K	
C714			CK73GB1H103K	CHIP C 0.010UF K		C795			CS77AA1A100M	CHIP TNTL 10UF 10WV	
C715			CK73GB1C473K	CHIP C 0.047UF K		C796			CK73GB1C473K	CHIP C 0.047UF K	
C716			CK73GB1H103K	CHIP C 0.010UF K		C798			CK73GB1H471K	CHIP C 470PF K	
C717			CS77AA1A100M	CHIP TNTL 10UF 10WV		C799			CS77AA1VR33M	CHIP TNTL 0.33UF 35WV	
C718			CK73GB1C473K	CHIP C 0.047UF K		C800			C93-0787-05	CHIP C 0.10UF J	
C720,721			CS77AA1A100M	CHIP TNTL 10UF 10WV		C802,803			CK73GB1C473K	CHIP C 0.047UF K	
C722,723			CC73GCH1H151J	CHIP C 150PF J		C804			CC73GCH1H101J	CHIP C 100PF J	
C724,725			CK73GB1C473K	CHIP C 0.047UF K		C806			CK73GB1C473K	CHIP C 0.047UF K	
C726		*	CS77AC1A101M	CHIP TNTL 100UF 10WV		C807			CC73GCH1H220J	CHIP C 22PF J	
C728			C92-0863-05	CHIP TAN 0.047UF 35WV		C808			CK73GB1H102K	CHIP C 1000PF K	
C729			CK73GB1C473K	CHIP C 0.047UF K		C809			CK73GB1C473K	CHIP C 0.047UF K	
C731			CC73GCH1H820J	CHIP C 82PF J		C810			CK73GB1H471K	CHIP C 470PF K	
C733			CK73GB1H102K	CHIP C 1000PF K		C811			CC73GCH1H101J	CHIP C 100PF J	
C734			CC73GCH1H390J	CHIP C 39PF J		C813			CC73GCH1H220J	CHIP C 22PF J	
C736			CS77AA1A100M	CHIP TNTL 10UF 10WV		C814			CK73GB1H102K	CHIP C 1000PF K	
C737			CC73GCH1H820J	CHIP C 82PF J		C815			CK73GB1C473K	CHIP C 0.047UF K	
C739			CS77CA1A3R3M	CHIP TNTL 3.3UF 10WV		C817			CK73GB1H102K	CHIP C 1000PF K	
C740			CK73GB1H102K	CHIP C 1000PF K		C818			CC73GCH1H120J	CHIP C 12PF J	
C741			CC73GCH1H220J	CHIP C 22PF J		C819			CK73GB1H472K	CHIP C 4700PF K	
C742			CC73GCH1H240J	CHIP C 24PF J		C820			CK73GB1H102K	CHIP C 1000PF K	
C743			CS77CA1A3R3M	CHIP TNTL 3.3UF 10WV		C821,822			CC73GCH1H120J	CHIP C 12PF J	
C744			CK73GB1H103K	CHIP C 0.010UF K		C823			CC73GCH1H240J	CHIP C 24PF J	
C745			CC73GCH1H270J	CHIP C 27PF J		C824			CC73GCH1H180J	CHIP C 18PF J	
C746			CK73GB1H102K	CHIP C 1000PF K		C825			CK73GB1H103K	CHIP C 0.010UF K	
C747			CS77AA1A100M	CHIP TNTL 10UF 10WV		C826			CC73GCH1H240J	CHIP C 24PF J	
C748			CK73GB1H102K	CHIP C 1000PF K		C827,828			CK73GB1H102K	CHIP C 1000PF K	
C749			CK73GB1H471K	CHIP C 470PF K		C830			CK73GB1H102K	CHIP C 1000PF K	
C750			CK73GB1C473K	CHIP C 0.047UF K		C831			CK73GB1H471K	CHIP C 470PF K	
C751,752			CS77CA1A3R3M	CHIP TNTL 3.3UF 10WV		C832			CK73GB1H102K	CHIP C 1000PF K	
C753,754			CK73GB1H182K	CHIP C 1800PF K		C835			CC73GCH1H100D	CHIP C 10PF D	
C755			CC73GCH1H180J	CHIP C 18PF J		C836			CK73GB1H103K	CHIP C 0.010UF K	
C756			CC73GCH1H100D	CHIP C 10PF D		C839			CK73GB1C473K	CHIP C 0.047UF K	
C757			CK73GB1C473K	CHIP C 0.047UF K		C840-842			CK73GB1H103K	CHIP C 0.010UF K	
C758			CK73GB1H471K	CHIP C 470PF K		C844		*	CS77AC1A101M	CHIP TNTL 100UF 10WV	
C759			CK73GB1H472K	CHIP C 4700PF K		C849-854			CS77AA1A100M	CHIP TNTL 10UF 10WV	
C761			CC73GCH1H101J	CHIP C 100PF J		C857-859			CK73GB1H102K	CHIP C 1000PF K	
C762			CK73GB1H102K	CHIP C 1000PF K		C860			CS77AA1A100M	CHIP TNTL 10UF 10WV	
C763,764			CC73GCH1H180J	CHIP C 18PF J		C861,862			CK73GB1H102K	CHIP C 1000PF K	
C765,766			CC73GCH1H100D	CHIP C 10PF D		C863,864			CK73GB1H471K	CHIP C 470PF K	
C767			CS77AA1A100M	CHIP TNTL 10UF 10WV		C865			CK73GB1H102K	CHIP C 1000PF K	
C770			CK73GB1H103K	CHIP C 0.010UF K		C866,867			CK73GB1H103K	CHIP C 0.010UF K	
C771			CS77AA1A100M	CHIP TNTL 10UF 10WV		C868			CS77AA1A100M	CHIP TNTL 10UF 10WV	
C772			CC73GCH1H101J	CHIP C 100PF J		C869,870			CK73GB1H102K	CHIP C 1000PF K	
C773,774			CK73GB1H103K	CHIP C 0.010UF K		C871			CK73GB1H472K	CHIP C 4700PF K	
C775			CK73GB1H102K	CHIP C 1000PF K		C872,873			CK73GB1H102K	CHIP C 1000PF K	
C776			CK73GB1H471K	CHIP C 470PF K		C874			CK73GB1C473K	CHIP C 0.047UF K	
C777			C92-0863-05	CHIP TNTL 0.047UF 35WV		C875			CK73GB1H103K	CHIP C 0.010UF K	
C778			CK73GB1H102K	CHIP C 1000PF K		C876			CC73GCH1H151J	CHIP C 150PF J	
C780			CK73GB1H471K	CHIP C 470PF K		C877,878			CC73GCH1H070B	CHIP C 7.0PF B	
C781			CC73GCH1H100D	CHIP C 10PF D		C879			CK73GB1H471K	CHIP C 470PF K	
C782			CC73GCH1H050B	CHIP C 5.0PF B		C880			CC73GCH1H020B	CHIP C 2.0PF B	
C783			CK73GB1H103K	CHIP C 0.010UF K		C881			CK73GB1H471K	CHIP C 470PF K	

PARTS LIST

TX-RX 2 UNIT (X57-606X-XX)

Ref. No.	Address	New parts	Parts No.	Description	Desti-nation	Ref. No.	Address	New parts	Parts No.	Description	Desti-nation
C882			CC73GCH1H020B	CHIP C 2.0PF B		CN11			E04-0191-05	PIN SOCKET	
C883,884			CC73GCH1H150J	CHIP C 15PF J		CN12			E40-5741-05	FLAT CABLE CONNECTOR	
C885			CK73GB1H102K	CHIP C 1000PF K		CN13			E04-0191-05	PIN SOCKET	
C886,887			CC73GCH1H150J	CHIP C 15PF J		CN14			E40-5978-05	FLAT CABLE CONNECTOR	
C888,889			CC73GCH1H010B	CHIP C 1.0PF B		CN15			E04-0154-05	PIN SOCKET	
C890			CC73GCH1H270J	CHIP C 27PF J		CN17			E40-5978-05	FLAT CABLE CONNECTOR	
C892,893			CC73GCH1H070B	CHIP C 7.0PF B		CN18			E04-0191-05	PIN SOCKET	
C894,895			CC73GCH1H060B	CHIP C 6.0PF B		CN19			E04-0154-05	PIN SOCKET	
C896			CK73GB1H103K	CHIP C 0.010UF K		CN501			E40-5740-05	FLAT CABLE CONNECTOR	
C897			CC73GCH1H120J	CHIP C 12PF J		CN502-506			E04-0191-05	PIN SOCKET	
C898			CK73GB1H471K	CHIP C 470PF K		CN510			E40-5699-05	PIN ASSY	
C899,900			CC73GCH1H330J	CHIP C 33PF J		CN511,512			E40-6019-05	PIN ASSY	
C901			CK73GB1H471K	CHIP C 470PF K		CN513			E40-5699-05	PIN ASSY	
C902			CC73GCH1H050B	CHIP C 5.0PF B		CN514			E40-6019-05	PIN ASSY	
C903			CK73GB1H471K	CHIP C 470PF K		CN530			E41-1682-05	PIN ASSY	
C904			CC73GCH1H050B	CHIP C 5.0PF B		CN532			E40-5699-05	PIN ASSY	
C905			CC73GCH1H070B	CHIP C 7.0PF B		CN533,534			E40-5758-05	FLAT CABLE CONNECTOR	
C906			CS77AA1A100M	CHIP TNTL 10UF 10WV		CN535			E40-5699-05	PIN ASSY	
C907,908			CC73GCH1H020B	CHIP C 2.0PF B		J1			E11-0705-05	PHONE JACK (9P)	
C909,910			CK73GB1H102K	CHIP C 1000PF K		J2			E11-0455-05	3.5D PHONE JACK (3P)	
C911			CC73GCH1H150J	CHIP C 15PF J		W1		*	E37-0885-15	LEAD WIRE WITH CONNECTOR	
C912			CK73GB1H471K	CHIP C 470PF K		W501			E37-0956-05	LEAD WIRE WITH CONNECTOR	
C913			CK73GB1H102K	CHIP C 1000PF K		W503			E37-0955-05	LEAD WIRE WITH CONNECTOR	
C914			CC73GCH1H150J	CHIP C 15PF J		-			F10-2345-04	SHIELDING CASE	
C915			CK73GB1H471K	CHIP C 470PF K		-			F10-2346-04	SHIELDING CASE	
C916,917			CC73GCH1H040B	CHIP C 4.0PF B		-			F10-2347-04	SHIELDING CASE	
C918			CC73GCH1H560J	CHIP C 56PF J		-			F10-2348-04	SHIELDING CASE	
C919,920			CK73GB1H102K	CHIP C 1000PF K		-		*	F10-2349-24	SHIELDING CASE	
C923			CK73GB1H471K	CHIP C 470PF K		401	1B		F10-2351-04	SHIELDING COVER	
C924			CK73GB1H472K	CHIP C 4700PF K		-		*	F10-2388-24	SHIELDING CASE	
C925,926			CC73GCH1H050B	CHIP C 5.0PF B		402	1B		F10-2389-04	SHIELDING COVER	
C927			CC73GCH1H020B	CHIP C 2.0PF B		-			F10-2390-04	SHIELDING CASE	
C928			CK73GB1H472K	CHIP C 4700PF K		-			F10-2391-04	SHIELDING CASE	
C929			CK73GB1H102K	CHIP C 1000PF K		-		*	F20-1186-14	INSULATING SHEET	
C930			CC73GCH1H050B	CHIP C 5.0PF B		-			F20-3320-04	INSULATING SHEET	
C931			CK73GB1H472K	CHIP C 4700PF K		-			G13-1789-04	CUSHION	
C932			CC73GCH1H270J	CHIP C 27PF J		-			G13-1790-04	CUSHION	
C933			CK73GB1H102K	CHIP C 1000PF K		-					
C934,935			CK73GB1H471K	CHIP C 470PF K		CF1			L72-0984-05	CERAMIC FILTER (455KHz)	
C936			CC73GCH1H330J	CHIP C 33PF J		CF2			L72-0986-05	CERAMIC FILTER (455KHz)	E1,E2,E3
C937			CC73GCH1H100D	CHIP C 10PF D		CF2			L72-0986-05	CERAMIC FILTER (455KHz)	E4,E5
C962-966			CC73GCH1H220J	CHIP C 22PF J		CF400		*	L72-1026-05	CERAMIC FILTER (8.4MHz)	
TC1-6			C05-0369-05	CERAMIC TRIMMER CAPACITOR		L1			L41-1095-33	SMALL FIXED INDUCTOR (1.0UH)	
TC8-10			C05-0369-05	CERAMIC TRIMMER CAPACITOR		L4,5			L92-0180-05	CHIP FERRITE	
TC12			C05-0370-05	CERAMIC TRIMMER CAPACITOR		L6			L40-8275-92	SMALL FIXED INDUCTOR (82NH)	
TC13			C05-0369-05	CERAMIC TRIMMER CAPACITOR		L7			L40-2785-92	SMALL FIXED INDUCTOR (270NH)	
TC14			C05-0370-05	CERAMIC TRIMMER CAPACITOR		L8,9			L39-1498-05	TOROIDAL COIL	
TC400,401		*	C05-0346-15	CERAMIC TRIMMER CAPACITOR (6PF)		L10			L40-1575-92	SMALL FIXED INDUCTOR (15NH)	
TC402		*	C05-0384-05	CERAMIC TRIMMER CAPACITOR (10PF)		L11			L40-1085-92	SMALL FIXED INDUCTOR (100NH)	
TC403		*	C05-0378-05	CERAMIC TRIMMER CAPACITOR (20PF)		L12,13			L40-1875-92	SMALL FIXED INDUCTOR (18NH)	
TC404,405			C05-0384-05	CERAMIC TRIMMER CAPACITOR (10PF)		L14,15			L40-4775-92	SMALL FIXED INDUCTOR (47NH)	
TC406		*	C05-0378-05	CERAMIC TRIMMER CAPACITOR (20PF)		L22			L41-1095-33	SMALL FIXED INDUCTOR (1.0UH)	
TC408-410			C05-0384-05	CERAMIC TRIMMER CAPACITOR (10PF)		L23		*	L34-4788-05	COIL	
CN1-4			E04-0191-05	PIN SOCKET		L27			L41-4775-33	SMALL FIXED INDUCTOR (47NH)	
CN6			E04-0191-05	PIN SOCKET		L28		*	L34-4788-05	COIL	
CN7			E41-1683-05	PIN ASSY		L29		*	L79-1868-05	FILTER	E1,E2,E3
CN8			E04-0191-05	PIN SOCKET		L29		*	L79-1868-05	FILTER	E4,E5,J
CN9			E41-1682-05	PIN ASSY		L29		*	L79-1868-05	FILTER	J1,J2,J3
CN10			E40-6525-05	PIN ASSY		L29		*	L79-1869-05	FILTER	K1,K2,K3

J : TS-2000S J1 : TS-2000V J2 : TS-2000SX J3 : TS-2000VX
 K1 : TS-2000 (K) K2 : TS-B2000 (K) K3 : TS-2000X (K)
 E1 : TS-2000 (E) E2 : TS-B2000 (E) E3 : TS-2000 (E2) E4 : TS-B2000 (E2) E5 : TS-2000X (E)

PARTS LIST

TX-RX 2 UNIT (X57-606X-XX)

Ref. No.	Address	New parts	Parts No.	Description	Desti-nation	Ref. No.	Address	New parts	Parts No.	Description	Desti-nation
L31			L40-1575-92	SMALL FIXED INDUCTOR (15NH)		L139			L40-4775-92	SMALL FIXED INDUCTOR (47NH)	
L32			L41-6875-33	SMALL FIXED INDUCTOR (68NH)		L140			L40-8265-92	SMALL FIXED INDUCTOR (8.2NH)	
L34		*	L34-4788-05	COIL		L141			L34-4604-05	AIR-CORE COIL	
L35			L41-6875-33	SMALL FIXED INDUCTOR (68NH)		L142-144			L40-1085-92	SMALL FIXED INDUCTOR (100NH)	
L39			L40-2275-92	SMALL FIXED INDUCTOR (22NH)		L145			L40-1585-92	SMALL FIXED INDUCTOR (150NH)	
L43			L40-8275-92	SMALL FIXED INDUCTOR (82NH)		L146			L40-5675-92	SMALL FIXED INDUCTOR (56NH)	
L44		*	L34-4788-05	COIL		L147			L41-5685-33	SMALL FIXED INDUCTOR (0.56UH)	
L45			L40-1875-92	SMALL FIXED INDUCTOR (18NH)		L148			L41-1095-33	SMALL FIXED INDUCTOR (1.0UH)	
L46			L40-1075-92	SMALL FIXED INDUCTOR (10NH)		L149			L41-4775-33	SMALL FIXED INDUCTOR (0.047UH)	
L47		*	L34-4788-05	COIL		L151			L40-1585-92	SMALL FIXED INDUCTOR (150NH)	
L48			L41-3375-33	SMALL FIXED INDUCTOR (33NH)		L154			L40-1085-92	SMALL FIXED INDUCTOR (100NH)	
L50		*	L79-1868-05	FILTER	E1,E2,E3	L155		*	L41-2785-33	SMALL FIXED INDUCTOR (0.27UH)	
L50		*	L79-1868-05	FILTER	E4,E5,J	L156		*	L41-3985-33	SMALL FIXED INDUCTOR (0.39UH)	
L50		*	L79-1868-05	FILTER	J1,J2,J3	L157			L41-6885-33	SMALL FIXED INDUCTOR (0.68UH)	
L50		*	L79-1869-05	FILTER	K1,K2,K3	L158			L41-1575-33	SMALL FIXED INDUCTOR (0.015UH)	
L52		*	L34-4788-05	COIL		L160			L40-1585-92	SMALL FIXED INDUCTOR (150NH)	
L55		*	L34-4788-05	COIL		L161			L40-4775-92	SMALL FIXED INDUCTOR (47NH)	
L59			L39-1498-05	TOROIDAL COIL		L162			L40-6875-92	SMALL FIXED INDUCTOR (68NH)	
L61-63			L39-1498-05	TOROIDAL COIL		L163,164		*	L34-4842-05	COIL	
L64,65			L92-0138-05	CHIP FERRITE		L165			L40-2285-92	SMALL FIXED INDUCTOR (220NH)	
L66-68			L39-1498-05	TOROIDAL COIL		L166,167			L41-4785-33	SMALL FIXED INDUCTOR (0.47UH)	
L69			L40-3381-37	SMALL FIXED INDUCTOR (0.330UH)		L168			L40-1085-92	SMALL FIXED INDUCTOR (100NH)	
L72			L40-3381-37	SMALL FIXED INDUCTOR (0.330UH)		L169			L41-1085-33	SMALL FIXED INDUCTOR (0.1UH)	
L73			L40-5675-92	SMALL FIXED INDUCTOR (56NH)		L170			L40-1575-92	SMALL FIXED INDUCTOR (15NH)	
L74			L40-3381-37	SMALL FIXED INDUCTOR (0.330UH)		L171			L40-4791-37	SMALL FIXED INDUCTOR (4.700UH)	
L75			L39-1498-05	TOROIDAL COIL		L172			L41-5685-33	SMALL FIXED INDUCTOR (0.56UH)	
L79			L40-5681-37	SMALL FIXED INDUCTOR (0.560UH)		L173			L40-2785-92	SMALL FIXED INDUCTOR (270NH)	
L80		*	L34-4827-05	COIL		L400,401		*	L41-1591-08	SMALL FIXED INDUCTOR (1.5NH)	
L82		*	L34-4828-05	COIL		L402,403			L34-4572-05	AIR-CORE COIL	
L83		*	L41-4705-39	SMALL FIXED INDUCTOR (47U)		L404			L40-1085-92	SMALL FIXED INDUCTOR (100NH)	
L85		*	L41-4705-39	SMALL FIXED INDUCTOR (47U)		L405			L40-1075-92	SMALL FIXED INDUCTOR (10NH)	
L86			L34-4649-05	COIL		L406		*	L41-4791-08	SMALL FIXED INDUCTOR (4.7NH)	
L89			L41-6885-33	SMALL FIXED INDUCTOR (680NH)		L407			L34-4573-05	AIR-CORE COIL	
L90		*	L34-4826-05	COIL		L408			L34-4572-05	AIR-CORE COIL	
L91		*	L34-4825-05	COIL		L409,410		*	L41-1015-39	SMALL FIXED INDUCTOR (100U)	
L93			L34-4787-05	COIL		L411		*	L41-2288-40	SMALL FIXED INDUCTOR (220NH)	
L95-97			L40-1085-92	SMALL FIXED INDUCTOR (100NH)		L412		*	L41-6888-40	SMALL FIXED INDUCTOR (680NH)	
L100		*	L41-3391-08	SMALL FIXED INDUCTOR (3.3NH)		L413		*	L34-4839-05	COIL	
L101			L92-0180-05	CHIP FERRITE		L414			L41-2295-39	SMALL FIXED INDUCTOR (2.2U)	
L102		*	L41-3391-08	SMALL FIXED INDUCTOR (3.3NH)		L415			L41-1875-43	SMALL FIXED INDUCTOR (18NH)	
L103-105			L41-5685-33	SMALL FIXED INDUCTOR (0.56UH)		L416		*	L41-1885-43	SMALL FIXED INDUCTOR (180NH)	
L106		*	L41-1875-33	SMALL FIXED INDUCTOR (0.018UH)		L417			L40-1575-92	SMALL FIXED INDUCTOR (15NH)	
L108,109			L34-4604-05	AIR-CORE COIL		L418			L40-1875-92	SMALL FIXED INDUCTOR (18NH)	
L110			L34-4605-05	AIR-CORE COIL		L419			L41-1005-39	SMALL FIXED INDUCTOR (10U)	
L111			L34-4603-05	AIR-CORE COIL		L420,421			L41-1075-33	SMALL FIXED INDUCTOR (0.01UH)	
L116			L34-4604-05	AIR-CORE COIL		L422		*	L34-4816-05	COIL	
L117			L34-4605-05	AIR-CORE COIL		L423			L41-6875-33	SMALL FIXED INDUCTOR (0.068UH)	
L118,119			L34-4604-05	AIR-CORE COIL		L424			L41-1005-39	SMALL FIXED INDUCTOR (10U)	
L121,122			L40-6865-92	SMALL FIXED INDUCTOR (6.8NH)		L425			L41-2295-39	SMALL FIXED INDUCTOR (2.2U)	
L123			L34-4605-05	AIR-CORE COIL		L426			L41-6875-33	SMALL FIXED INDUCTOR (0.068UH)	
L124			L40-4763-92	SMALL FIXED INDUCTOR (4.7NH)		L427		*	L34-4816-05	COIL	
L125			L40-1575-92	SMALL FIXED INDUCTOR (15NH)		L428			L41-1005-39	SMALL FIXED INDUCTOR (10U)	
L128			L34-4605-05	AIR-CORE COIL		L429		*	L41-4705-39	SMALL FIXED INDUCTOR (47U)	
L129			L34-4603-05	AIR-CORE COIL		L430			L41-6875-33	SMALL FIXED INDUCTOR (0.068UH)	
L130		*	L41-3391-08	SMALL FIXED INDUCTOR (3.3NH)		L431			L41-2295-39	SMALL FIXED INDUCTOR (2.2U)	
L131			L40-5675-92	SMALL FIXED INDUCTOR (56NH)		L432		*	L41-1275-33	SMALL FIXED INDUCTOR (0.012U)	
L132		*	L41-1875-33	SMALL FIXED INDUCTOR (0.018UH)		L433			L41-1005-39	SMALL FIXED INDUCTOR (10U)	
L133			L34-4605-05	AIR-CORE COIL		L434			L41-1085-33	SMALL FIXED INDUCTOR (0.1UH)	
L134			L40-1085-92	SMALL FIXED INDUCTOR (100NH)		L435			L41-1575-33	SMALL FIXED INDUCTOR (0.015UH)	
L137			L34-4603-05	AIR-CORE COIL		L436			L41-1585-33	SMALL FIXED INDUCTOR (0.15UH)	

PARTS LIST

TX-RX 2 UNIT (X57-606X-XX)

Ref. No.	Address	New parts	Parts No.	Description	Desti-nation	Ref. No.	Address	New parts	Parts No.	Description	Desti-nation
L437			L41-2295-39	SMALL FIXED INDUCTOR (2.2U)		L508		*	L41-1015-39	SMALL FIXED INDUCTOR (100U)	
L438			L41-1005-39	SMALL FIXED INDUCTOR (10U)		L509			L41-1005-39	SMALL FIXED INDUCTOR (10U)	
L439		*	L41-1885-33	SMALL FIXED INDUCTOR (0.18UH)		L510		*	L41-1015-39	SMALL FIXED INDUCTOR (100U)	
L440			L41-1005-39	SMALL FIXED INDUCTOR (10U)		L511			L41-1005-39	SMALL FIXED INDUCTOR (10U)	
L441			L41-1595-33	SMALL FIXED INDUCTOR (1.5UH)		L512		*	L41-1015-39	SMALL FIXED INDUCTOR (100U)	
L442		*	L41-2785-33	SMALL FIXED INDUCTOR (0.27UH)		L513,514			L40-6875-92	SMALL FIXED INDUCTOR (68NH)	
L443			L41-1005-39	SMALL FIXED INDUCTOR (10U)		L515,516			L41-1005-39	SMALL FIXED INDUCTOR (10U)	
L444,445		*	L41-1295-39	SMALL FIXED INDUCTOR (1.2U)		L517,518		*	L41-1275-33	SMALL FIXED INDUCTOR (0.012UH)	
L446		*	L41-6891-08	SMALL FIXED INDUCTOR (6.8NH)		L519		*	L41-1015-39	SMALL FIXED INDUCTOR (100U)	
L447		*	L41-1295-39	SMALL FIXED INDUCTOR (1.2U)		L520,521			L41-1575-33	SMALL FIXED INDUCTOR (0.015UH)	
L448,449			L41-1005-39	SMALL FIXED INDUCTOR (10U)		L522,523		*	L41-2775-33	SMALL FIXED INDUCTOR (0.027UH)	
L450		*	L34-4839-05	COIL		L524			L41-5675-33	SMALL FIXED INDUCTOR (0.056UH)	
L451			L41-1005-39	SMALL FIXED INDUCTOR (10U)		L525			L41-3375-33	SMALL FIXED INDUCTOR (0.033UH)	
L452		*	L41-1591-08	SMALL FIXED INDUCTOR (1.5NH)		L526		*	L41-1875-33	SMALL FIXED INDUCTOR (0.018UH)	
L453		*	L41-3995-33	SMALL FIXED INDUCTOR (3.9UH)		L527			L41-3375-33	SMALL FIXED INDUCTOR (0.033UH)	
L454,455			L41-1005-39	SMALL FIXED INDUCTOR (10U)		L528-530		*	L41-1875-33	SMALL FIXED INDUCTOR (0.018UH)	
L456			L41-1595-33	SMALL FIXED INDUCTOR (1.5UH)		L531			L41-1095-33	SMALL FIXED INDUCTOR (1.0UH)	
L457,458		*	L41-3995-33	SMALL FIXED INDUCTOR (3.9UH)		L532			L41-6875-33	SMALL FIXED INDUCTOR (0.068UH)	
L459		*	L41-6891-08	SMALL FIXED INDUCTOR (6.8NH)		L533,534			L41-1005-39	SMALL FIXED INDUCTOR (10U)	
L460			L41-1005-39	SMALL FIXED INDUCTOR (10U)		L535,536		*	L41-2785-33	SMALL FIXED INDUCTOR (0.27UH)	
L460,461			L41-1005-39	SMALL FIXED INDUCTOR (10U)		L537			L40-1075-92	SMALL FIXED INDUCTOR (10NH)	
L462			L41-4795-39	SMALL FIXED INDUCTOR (4.7U)		X1			L77-1828-05	CRYSTAL RESONATOR (58.07MHz)	
L463			L40-2278-60	SMALL FIXED INDUCTOR (22NH)		X400		*	L77-1820-15	TCXO (15.600MHz)	
L464			L41-4795-39	SMALL FIXED INDUCTOR (4.7U)		XF1			L71-0566-05	MCF (41.895MHz)	
L465			L41-1095-33	SMALL FIXED INDUCTOR (1.0UH)		XF2		*	L71-0565-15	MCF (58.525M)	
L466			L41-1005-33	SMALL FIXED INDUCTOR (10UH)		XF3			L71-0582-05	MCF (41.795MHz/15K)	
L467		*	L41-3995-33	SMALL FIXED INDUCTOR (3.9UH)		S	1B	*	N87-2605-48	BRAZIER HEAD TAPTITE SCREW	
L468,469			L41-5695-39	SMALL FIXED INDUCTOR (5.6U)		R1			RK73GB2A000J	CHIP R 0.0 J 1/10W	
L470			L41-1585-33	SMALL FIXED INDUCTOR (0.15UH)		R2,3			RK73GB2A102J	CHIP R 1.0K J 1/10W	
L471			L41-4795-39	SMALL FIXED INDUCTOR (4.7U)		R4,5			RK73GB2A222J	CHIP R 2.2K J 1/10W	
L472			L40-6878-60	SMALL FIXED INDUCTOR (68NH)		R6,7			RK73GB2A102J	CHIP R 1.0K J 1/10W	
L473			L41-1005-33	SMALL FIXED INDUCTOR (10UH)		R8,9			RK73GB2A222J	CHIP R 2.2K J 1/10W	
L474			L41-1595-33	SMALL FIXED INDUCTOR (1.5UH)		R10			RK73GB2A103J	CHIP R 10K J 1/10W	
L475			L41-5695-39	SMALL FIXED INDUCTOR (5.6U)		R11			RK73GB2A100J	CHIP R 10 J 1/10W	
L476		*	L41-6891-08	SMALL FIXED INDUCTOR (6.8NH)		R13,14			RK73GB2A103J	CHIP R 10K J 1/10W	
L477			L40-2285-92	SMALL FIXED INDUCTOR (220NH)		R15			RK73GB2A153J	CHIP R 15K J 1/10W	
L478			L41-1005-33	SMALL FIXED INDUCTOR (10UH)		R16			RK73GB2A103J	CHIP R 10K J 1/10W	
L479		*	L34-4839-05	COIL		R18			RK73GB2A271J	CHIP R 270 J 1/10W	
L480			L40-2285-92	SMALL FIXED INDUCTOR (220NH)		R19			RK73GB2A102J	CHIP R 1.0K J 1/10W	
L481		*	L41-1275-33	SMALL FIXED INDUCTOR (0.012UH)		R20			RK73GB2A223J	CHIP R 22K J 1/10W	K1,K2,K3
L482		*	L41-2775-33	SMALL FIXED INDUCTOR (0.027UH)		R20			RK73GB2A562J	CHIP R 5.6K J 1/10W	E1,E2,E3
L483		*	L41-3995-33	SMALL FIXED INDUCTOR (3.9UH)		R20			RK73GB2A562J	CHIP R 5.6K J 1/10W	E4,E5,J
L485,486			L41-1005-39	SMALL FIXED INDUCTOR (10U)		R20			RK73GB2A562J	CHIP R 5.6K J 1/10W	
L487		*	L41-1015-39	SMALL FIXED INDUCTOR (100U)		R21			RK73GB2A562J	CHIP R 5.6K J 1/10W	J1,J2,J3
L488			L41-1005-39	SMALL FIXED INDUCTOR (10U)		R22			RK73GB2A471J	CHIP R 470 J 1/10W	
L490			L41-1585-33	SMALL FIXED INDUCTOR (0.15UH)		R22			RK73GB2A470J	CHIP R 47 J 1/10W	
L492,493		*	L41-2291-08	SMALL FIXED INDUCTOR (2.2NH)		R23			RK73GB2A222J	CHIP R 2.2K J 1/10W	
L494		*	L34-4824-05	COIL		R24			RK73GB2A331J	CHIP R 330 J 1/10W	
L495		*	L34-4835-05	COIL		R25			RK73GB2A680J	CHIP R 68 J 1/10W	
L496			L41-1005-39	SMALL FIXED INDUCTOR (10U)		R26			RK73GB2A471J	CHIP R 470 J 1/10W	
L497			L41-1095-33	SMALL FIXED INDUCTOR (1.0UH)		R27			RK73GB2A101J	CHIP R 100 J 1/10W	
L498			L41-1005-39	SMALL FIXED INDUCTOR (10U)		R28,29			RK73GB2A471J	CHIP R 470 J 1/10W	
L500			L41-2285-33	SMALL FIXED INDUCTOR (0.22UH)		R30			RK73GB2A472J	CHIP R 4.7K J 1/10W	E1,E2,E3
L501			L41-1005-39	SMALL FIXED INDUCTOR (10U)		R30			RK73GB2A472J	CHIP R 4.7K J 1/10W	E4,E5
L502			L41-1595-33	SMALL FIXED INDUCTOR (1.5UH)		R31			RK73GB2A471J	CHIP R 470 J 1/10W	
L503		*	L41-2291-08	SMALL FIXED INDUCTOR (2.2NH)		R32			RK73GB2A561J	CHIP R 560 J 1/10W	
L504		*	L34-4823-05	COIL		R33			RK73GB2A3R3J	CHIP R 3.3 J 1/10W	
L505			L41-1595-33	SMALL FIXED INDUCTOR (1.5UH)		R34			RK73GB2A561J	CHIP R 560 J 1/10W	
L506			L41-3375-33	SMALL FIXED INDUCTOR (0.033UH)		R35,36			RK73GB2A102J	CHIP R 1.0K J 1/10W	
L507			L41-1005-39	SMALL FIXED INDUCTOR (10U)							

J : TS-2000S J1 : TS-2000V J2 : TS-2000SX J3 : TS-2000VX
 K1 : TS-2000 (K) K2 : TS-B2000 (K) K3 : TS-2000X (K)
 E1 : TS-2000 (E) E2 : TS-B2000 (E) E3 : TS-2000 (E2) E4 : TS-B2000 (E2) E5 : TS-2000X (E)

PARTS LIST

TX-RX 2 UNIT (X57-606X-XX)

Ref. No.	Address	New parts	Parts No.	Description	Destination	Ref. No.	Address	New parts	Parts No.	Description	Destination
R37			RK73GB2A222J	CHIP R 2.2K J 1/10W		R108			RK73FB2B470J	CHIP R 47 J 1/8W	
R38			RK73GB2A332J	CHIP R 3.3K J 1/10W		R109			RK73GB2A181J	CHIP R 180 J 1/10W	
R39			RK73GB2A102J	CHIP R 1.0K J 1/10W		R110,111			RK73GB2A104J	CHIP R 100K J 1/10W	
R40			RK73GB2A222J	CHIP R 2.2K J 1/10W		R112,113			RK73GB2A472J	CHIP R 4.7K J 1/10W	
R41			RK73FB2B221J	CHIP R 220 J 1/8W		R114			RK73GB2A272J	CHIP R 2.7K J 1/10W	
R42			RK73GB2A103J	CHIP R 10K J 1/10W		R115			RK73GB2A104J	CHIP R 100K J 1/10W	
R43			RK73GB2A331J	CHIP R 330 J 1/10W		R116,117			RK73GB2A000J	CHIP R 0 OHM J 1/10W	
R44			RK73GB2A101J	CHIP R 100 J 1/10W		R118			RK73GB2A272J	CHIP R 2.7K J 1/10W	
R45,46			RK73GB2A102J	CHIP R 1.0K J 1/10W		R119			RK73GB2A000J	CHIP R 0 OHM J 1/10W	
R47			RK73GB2A181J	CHIP R 180 J 1/10W		R120,121			RK73GB2A104J	CHIP R 100K J 1/10W	
R48-50			RK73GB2A101J	CHIP R 100 J 1/10W		R122			RK73GB2A330J	CHIP R 33 J 1/10W	
R51			RK73GB2A472J	CHIP R 4.7K J 1/10W		R123			RK73GB2A331J	CHIP R 330 J 1/10W	
R52			RK73GB2A272J	CHIP R 2.7K J 1/10W		R124			RK73GB2A102J	CHIP R 1.0K J 1/10W	
R53			RK73GB2A332J	CHIP R 3.3K J 1/10W		R125			RK73GB2A104J	CHIP R 100K J 1/10W	
R54			RK73GB2A272J	CHIP R 2.7K J 1/10W		R126-128			RK73GB2A102J	CHIP R 1.0K J 1/10W	
R55-59			RK73GB2A102J	CHIP R 1.0K J 1/10W		R129			RK73GB2A223J	CHIP R 22K J 1/10W	
R60			RK73GB2A104J	CHIP R 100K J 1/10W		R130			RK73GB2A561J	CHIP R 560 J 1/10W	
R61,62			RK73GB2A222J	CHIP R 2.2K J 1/10W		R131			RK73GB2A102J	CHIP R 1.0K J 1/10W	
R63			RK73GB2A471J	CHIP R 470 J 1/10W		R132			RK73GB2A3R3J	CHIP R 3.3 J 1/10W	
R64			RK73GB2A104J	CHIP R 100K J 1/10W		R133			RK73GB2A102J	CHIP R 1.0K J 1/10W	
R66			RK73GB2A101J	CHIP R 100 J 1/10W		R135,136			RK73GB2A104J	CHIP R 100K J 1/10W	
R67-70			RK73GB2A104J	CHIP R 100K J 1/10W		R137			RK73GB2A821J	CHIP R 820 J 1/10W	
R71			RK73GB2A472J	CHIP R 4.7K J 1/10W		R139			RK73GB2A104J	CHIP R 100K J 1/10W	
R72			RK73GB2A272J	CHIP R 2.7K J 1/10W		R140			RK73GB2A331J	CHIP R 330 J 1/10W	
R73			RK73FB2B470J	CHIP R 47 J 1/8W		R141			RK73GB2A102J	CHIP R 1.0K J 1/10W	
R74			RK73GB2A222J	CHIP R 2.2K J 1/10W		R142,143			RK73GB2A101J	CHIP R 100 J 1/10W	
R75			RK73FB2B220J	CHIP R 22 J 1/8W		R146,147			RK73GB2A222J	CHIP R 2.2K J 1/10W	
R76			RK73GB2A472J	CHIP R 4.7K J 1/10W		R149			RK73GB2A331J	CHIP R 330 J 1/10W	
R77			RK73GB2A272J	CHIP R 2.7K J 1/10W		R150,151			RK73GB2A561J	CHIP R 560 J 1/10W	
R79			RK73GB2A181J	CHIP R 180 J 1/10W		R152			RK73GB2A102J	CHIP R 1.0K J 1/10W	
R80			RK73FB2B470J	CHIP R 47 J 1/8W		R153			RK73GB2A180J	CHIP R 18 J 1/10W	
R81			RK73GB2A152J	CHIP R 1.5K J 1/10W		R154			RK73GB2A3R3J	CHIP R 3.3 J 1/10W	
R82			RK73GB2A103J	CHIP R 10K J 1/10W		R155			RK73GB2A390J	CHIP R 39 J 1/10W	
R83			RK73FB2B220J	CHIP R 22 J 1/8W		R156			RK73GB2A561J	CHIP R 560 J 1/10W	
R84			RK73GB2A823J	CHIP R 82K J 1/10W		R157			RK73GB2A331J	CHIP R 330 J 1/10W	
R85			RK73GB2A333J	CHIP R 33K J 1/10W		R158			RK73GB2A102J	CHIP R 1.0K J 1/10W	
R86			RK73GB2A473J	CHIP R 47K J 1/10W		R159			RK73GB2A390J	CHIP R 39 J 1/10W	
R87			RK73GB2A103J	CHIP R 10K J 1/10W		R160-163			RK73GB2A102J	CHIP R 1.0K J 1/10W	
R88			RK73GB2A472J	CHIP R 4.7K J 1/10W		R164			RK73GB2A470J	CHIP R 47 J 1/10W	
R89			RK73GB2A272J	CHIP R 2.7K J 1/10W		R165			RK73GB2A332J	CHIP R 3.3K J 1/10W	
R90			RK73FB2B470J	CHIP R 47 J 1/8W		R166			RK73GB2A000J	CHIP R 0 OHM J 1/10W	
R91			RK73GB2A222J	CHIP R 2.2K J 1/10W		R167			RK73GB2A681J	CHIP R 680 J 1/10W	
R92			RK73GB2A104J	CHIP R 100K J 1/10W		R168			RK73GB2A330J	CHIP R 33 J 1/10W	
R93			RK73GB2A102J	CHIP R 1.0K J 1/10W		R169			RK73GB2A181J	CHIP R 180 J 1/10W	
R94			RK73GB2A471J	CHIP R 470 J 1/10W		R170			RK73GB2A472J	CHIP R 4.7K J 1/10W	
R95			RK73GB2A472J	CHIP R 4.7K J 1/10W		R171			RK73GB2A272J	CHIP R 2.7K J 1/10W	
R96			RK73GB2A272J	CHIP R 2.7K J 1/10W		R172			RK73GB2A101J	CHIP R 100 J 1/10W	
R97			RK73GB2A120J	CHIP R 12 J 1/10W	E1,E2,E3	R173			RK73GB2A121J	CHIP R 120 J 1/10W	
R97			RK73GB2A120J	CHIP R 12 J 1/10W	E4,E5,J	R174			RK73GB2A270J	CHIP R 27 J 1/10W	
R97			RK73GB2A120J	CHIP R 12 J 1/10W	J1,J2,J3	R175			RK73GB2A330J	CHIP R 33 J 1/10W	
R97			RK73GB2A150J	CHIP R 15 J 1/10W	K1,K2,K3	R176			RK73GB2A562J	CHIP R 5.6K J 1/10W	
R98			RK73GB2A103J	CHIP R 10K J 1/10W		R177			RK73GB2A182J	CHIP R 1.8K J 1/10W	
R99			RK73GB2A222J	CHIP R 2.2K J 1/10W		R178			RK73GB2A472J	CHIP R 4.7K J 1/10W	
R100			RK73GB2A104J	CHIP R 100K J 1/10W		R179			RK73GB2A272J	CHIP R 2.7K J 1/10W	
R101			RK73FB2B470J	CHIP R 47 J 1/8W		R180			RK73GB2A562J	CHIP R 5.6K J 1/10W	
R102			RK73GB2A222J	CHIP R 2.2K J 1/10W		R181			RK73GB2A182J	CHIP R 1.8K J 1/10W	
R103			RK73FB2B220J	CHIP R 22 J 1/8W		R185			RK73GB2A102J	CHIP R 1.0K J 1/10W	
R104,105			RK73GB2A101J	CHIP R 100 J 1/10W		R187			RK73GB2A393J	CHIP R 39K J 1/10W	
R106			RK73FB2B470J	CHIP R 47 J 1/8W		R188			RK73GB2A104J	CHIP R 100K J 1/10W	
R107			RK73GB2A222J	CHIP R 2.2K J 1/10W		R189			RK73GB2A273J	CHIP R 27K J 1/10W	

PARTS LIST

TX-RX 2 UNIT (X57-606X-XX)

Ref. No.	Address	New parts	Parts No.	Description	Desti-nation	Ref. No.	Address	New parts	Parts No.	Description	Desti-nation
R190			RK73GB2A180J	CHIP R 18 J 1/10W		R268			RK73GB2A274J	CHIP R 270K J 1/10W	
R191			RK73GB2A273J	CHIP R 27K J 1/10W		R269			RK73GB2A564J	CHIP R 560K J 1/10W	
R192			RK73GB2A000J	CHIP R 0 OHM J 1/10W		R271			RK73GB2A223J	CHIP R 22K J 1/10W	
R194			RK73GB2A471J	CHIP R 470 J 1/10W		R272			RK73GB2A104J	CHIP R 100K J 1/10W	
R195			RK73GB2A823J	CHIP R 82K J 1/10W		R276			RK73GB2A101J	CHIP R 100 J 1/10W	
R196			RK73GB2A103J	CHIP R 10K J 1/10W		R277			RK73GB2A183J	CHIP R 18K J 1/10W	
R197-199			RK73GB2A101J	CHIP R 100 J 1/10W		R278			RK73GB2A122J	CHIP R 1.2K J 1/10W	
R200			RK73GB2A182J	CHIP R 1.8K J 1/10W		R286			RK73GB2A000J	CHIP R 0 OHM J 1/10W	
R201			RK73GB2A273J	CHIP R 27K J 1/10W		R287			RK73GB2A563J	CHIP R 56K J 1/10W	
R202			RK73GB2A471J	CHIP R 470 J 1/10W		R288			RK73GB2A102J	CHIP R 1.0K J 1/10W	
R203			RK73GB2A102J	CHIP R 1.0K J 1/10W		R289			RK73GB2A103J	CHIP R 10K J 1/10W	
R204			RK73GB2A184J	CHIP R 180K J 1/10W		R291			RK73GB2A471J	CHIP R 470 J 1/10W	
R205			RK73GB2A102J	CHIP R 1.0K J 1/10W		R295			RK73GB2A102J	CHIP R 1.0K J 1/10W	
R206			RK73GB2A154J	CHIP R 150K J 1/10W		R296			RK73GB2A471J	CHIP R 470 J 1/10W	
R207			RK73GB2A000J	CHIP R 0 OHM J 1/10W		R297,298			RK73GB2A102J	CHIP R 1.0K J 1/10W	
R208			RK73GB2A332J	CHIP R 3.3K J 1/10W		R300,301			RK73GB2A560J	CHIP R 56 J 1/10W	
R209			RK73GB2A000J	CHIP R 0 OHM J 1/10W		R303			RK73GB2A151J	CHIP R 150 J 1/10W	
R210			RK73GB2A102J	CHIP R 1.0K J 1/10W		R304,305			RK73GB2A000J	CHIP R 0 OHM J 1/10W	J,J1,J2
R211			RK73GB2A153J	CHIP R 15K J 1/10W	E1,E2,E3	R304,305			RK73GB2A000J	CHIP R 0 OHM J 1/10W	J3
R211			RK73GB2A153J	CHIP R 15K J 1/10W	E4,E5	R304,305			RK73GB2A000J	CHIP R 0 OHM J 1/10W	K1,K2,K3
R212			RK73GB2A563J	CHIP R 56K J 1/10W		R306			RK73GB2A182J	CHIP R 1.8K J 1/10W	
R213,214			RK73GB2A222J	CHIP R 2.2K J 1/10W		R307,308			RK73GB2A103J	CHIP R 10K J 1/10W	
R215			RK73GB2A101J	CHIP R 100 J 1/10W		R309			RK73GB2A182J	CHIP R 1.8K J 1/10W	
R216			RK73GB2A333J	CHIP R 33K J 1/10W		R310			RK73GB2A472J	CHIP R 4.7K J 1/10W	
R217			RK73GB2A103J	CHIP R 10K J 1/10W		R311,312			RK73GB2A000J	CHIP R 0 OHM J 1/10W	
R218			RK73GB2A102J	CHIP R 1.0K J 1/10W		R313			RK73GB2A103J	CHIP R 10K J 1/10W	
R219			RK73GB2A101J	CHIP R 100 J 1/10W		R314,315			RK73GB2A472J	CHIP R 4.7K J 1/10W	
R220,221			RK73GB2A223J	CHIP R 22K J 1/10W	E1,E2,E3	R316			RK73GB2A103J	CHIP R 10K J 1/10W	
R220,221			RK73GB2A223J	CHIP R 22K J 1/10W	E4,E5	R317			RK73GB2A471J	CHIP R 470 J 1/10W	
R222			RK73GB2A682J	CHIP R 6.8K J 1/10W		R319,320			RK73GB2A331J	CHIP R 330 J 1/10W	
R223			RK73GB2A100J	CHIP R 10 J 1/10W		R321			RK73GB2A820J	CHIP R 82 J 1/10W	
R224			RK73GB2A221J	CHIP R 220 J 1/10W		R322			RK73GB2A102J	CHIP R 1.0K J 1/10W	
R225,226			RK73GB2A223J	CHIP R 22K J 1/10W	E1,E2,E3	R323			RK73GB2A331J	CHIP R 330 J 1/10W	
R225,226			RK73GB2A223J	CHIP R 22K J 1/10W	E4,E5	R325-327			RK73GB2A101J	CHIP R 100 J 1/10W	
R229			RK73GB2A822J	CHIP R 8.2K J 1/10W		R328			RK73GB2A102J	CHIP R 1.0K J 1/10W	
R230			RK73GB2A000J	CHIP R 0 OHM J 1/10W		R329			RK73GB2A682J	CHIP R 6.8K J 1/10W	
R231			RK73GB2A331J	CHIP R 330 J 1/10W		R333			RK73GB2A153J	CHIP R 15K J 1/10W	
R232			RK73GB2A221J	CHIP R 220 J 1/10W		R335			RK73GB2A102J	CHIP R 1.0K J 1/10W	
R233			RK73GB2A223J	CHIP R 22K J 1/10W		R336			RK73GB2A271J	CHIP R 270 J 1/10W	
R235			RK73GB2A473J	CHIP R 47K J 1/10W		R337			RK73GB2A330J	CHIP R 33 J 1/10W	
R236			RK73GB2A153J	CHIP R 15K J 1/10W	E1,E2,E3	R338			RK73GB2A152J	CHIP R 1.5K J 1/10W	
R236			RK73GB2A153J	CHIP R 15K J 1/10W	E4,E5	R340			RK73GB2A000J	CHIP R 0 OHM J 1/10W	
R237,238			RK73GB2A331J	CHIP R 330 J 1/10W		R342			RK73GB2A104J	CHIP R 100K J 1/10W	
R240,241			RK73GB2A330J	CHIP R 33 J 1/10W		R343,344			RK73GB2A331J	CHIP R 330 J 1/10W	
R242			RK73GB2A222J	CHIP R 2.2K J 1/10W		R345			RK73GB2A682J	CHIP R 6.8K J 1/10W	
R245			RK73GB2A183J	CHIP R 18K J 1/10W		R346,347			RK73GB2A103J	CHIP R 10K J 1/10W	
R246,247			RK73GB2A680J	CHIP R 68 J 1/10W		R348			RK73GB2A182J	CHIP R 1.8K J 1/10W	
R248			RK73GB2A103J	CHIP R 10K J 1/10W		R349			RK73GB2A000J	CHIP R 0 OHM J 1/10W	E1,E2,E3
R250			RK73GB2A271J	CHIP R 270 J 1/10W		R349			RK73GB2A000J	CHIP R 0 OHM J 1/10W	E4,E5,J
R254			RK73GB2A100J	CHIP R 10 J 1/10W		R349			RK73GB2A000J	CHIP R 0 OHM J 1/10W	J1,J2,J3
R255			RK73GB2A472J	CHIP R 4.7K J 1/10W		R349,350			RK73GB2A000J	CHIP R 0 OHM J 1/10W	K1,K2,K3
R256			RK73GB2A180J	CHIP R 18 J 1/10W		R350			RK73GB2A100J	CHIP R 10 J 1/10W	E1,E2,E3
R257			RK73GB2A103J	CHIP R 10K J 1/10W		R350			RK73GB2A100J	CHIP R 10 J 1/10W	E4,E5,J
R258			RK73GB2A180J	CHIP R 18 J 1/10W		R350			RK73GB2A100J	CHIP R 10 J 1/10W	J1,J2,J3
R259,260			RK73GB2A222J	CHIP R 2.2K J 1/10W		R351			RK73GB2A823J	CHIP R 82K J 1/10W	
R262			RK73GB2A332J	CHIP R 3.3K J 1/10W		R352			RK73GB2A104J	CHIP R 100K J 1/10W	
R263			RK73GB2A180J	CHIP R 18 J 1/10W		R353			RK73GB2A103J	CHIP R 10K J 1/10W	
R265			RK73GB2A221J	CHIP R 220 J 1/10W		R354			RK73GB2A000J	CHIP R 0 OHM J 1/10W	
R266			RK73GB2A223J	CHIP R 22K J 1/10W		R355			RK73GB2A472J	CHIP R 4.7K J 1/10W	
R267			RK73GB2A822J	CHIP R 8.2K J 1/10W		R356			RK73GB2A103J	CHIP R 10K J 1/10W	

J : TS-2000S J1 : TS-2000V J2 : TS-2000SX J3 : TS-2000VX
 K1 : TS-2000 (K) K2 : TS-B2000 (K) K3 : TS-2000X (K)
 E1 : TS-2000 (E) E2 : TS-B2000 (E) E3 : TS-2000 (E2) E4 : TS-B2000 (E2) E5 : TS-2000X (E)

PARTS LIST

TX-RX 2 UNIT (X57-606X-XX)

Ref. No.	Address	New parts	Parts No.	Description	Destination	Ref. No.	Address	New parts	Parts No.	Description	Destination
R357			RK73GB2A470J	CHIP R 47 J 1/10W		R447,448			RK73GB2A101J	CHIP R 100 J 1/10W	
R358			RK73GB2A000J	CHIP R 0 OHM J 1/10W		R449			RK73GB2A103J	CHIP R 10K J 1/10W	
R359			RK73GB2A223J	CHIP R 22K J 1/10W		R450			RK73GB2A224J	CHIP R 220K J 1/10W	
R360			RK73GB2A474J	CHIP R 470K J 1/10W		R451			RK73GB2A391J	CHIP R 390 J 1/10W	
R361			RK73GB2A272J	CHIP R 2.7K J 1/10W		R452			RK73GB2A000J	CHIP R 0 OHM J 1/10W	
R362			RK73GB2A000J	CHIP R 0 OHM J 1/10W		R453			RK73GB2A153J	CHIP R 15K J 1/10W	
R363			RK73GB2A153J	CHIP R 15K J 1/10W		R454			RK73GB2A682J	CHIP R 6.8K J 1/10W	
R364			RK73GB2A103J	CHIP R 10K J 1/10W		R455			RK73GB2A153J	CHIP R 15K J 1/10W	
R365			RK73GB2A000J	CHIP R 0 OHM J 1/10W		R456			RK73GB2A682J	CHIP R 6.8K J 1/10W	
R366			RK73GB2A221J	CHIP R 220 J 1/10W		R457			RK73GB2A470J	CHIP R 47 J 1/10W	
R368			RK73GB2A221J	CHIP R 220 J 1/10W		R458			RK73GB2A153J	CHIP R 15K J 1/10W	
R369			RK73GB2A273J	CHIP R 27K J 1/10W		R459			RK73GB2A682J	CHIP R 6.8K J 1/10W	
R370			RK73GB2A471J	CHIP R 470 J 1/10W		R460			RK73GB2A220J	CHIP R 22 J 1/10W	
R371			RK73GB2A822J	CHIP R 8.2K J 1/10W		R461			RK73GB2A181J	CHIP R 180 J 1/10W	
R372			RK73GB2A153J	CHIP R 15K J 1/10W		R462			RK73GB2A470J	CHIP R 47 J 1/10W	
R373			RK73GB2A391J	CHIP R 390 J 1/10W		R463			RK73GB2A181J	CHIP R 180 J 1/10W	
R374-376			RK73GB2A101J	CHIP R 100 J 1/10W		R464,465			RK73GB2A101J	CHIP R 100 J 1/10W	
R377			RK73GB2A560J	CHIP R 56 J 1/10W		R466			RK73GB2A470J	CHIP R 47 J 1/10W	
R378			RK73GB2A224J	CHIP R 220K J 1/10W		R467			RK73GB2A181J	CHIP R 180 J 1/10W	
R379			RK73GB2A474J	CHIP R 470K J 1/10W		R468			RK73GB2A470J	CHIP R 47 J 1/10W	
R380			RK73GB2A684J	CHIP R 680K J 1/10W		R469			RK73GB2A391J	CHIP R 390 J 1/10W	
R381			RK73GB2A104J	CHIP R 100K J 1/10W		R470			RK73GB2A120J	CHIP R 12 J 1/10W	
R382			RK73GB2A474J	CHIP R 470K J 1/10W		R471			RK73GB2A000J	CHIP R 0 OHM J 1/10W	
R383			RK73GB2A391J	CHIP R 390 J 1/10W		R472			RK73GB2A470J	CHIP R 47 J 1/10W	
R384			RK73GB2A000J	CHIP R 0 OHM J 1/10W		R473			RK73GB2A821J	CHIP R 820 J 1/10W	
R385-387			RK73EB2E000J	CHIP R 0 OHM J 1/4W		R474			RK73GB2A391J	CHIP R 390 J 1/10W	
R388,389			RK73FB2B000J	CHIP R 0 OHM J 1/8W		R475			RK73GB2A181J	CHIP R 180 J 1/10W	
R390			RK73GB2A102J	CHIP R 1.0K J 1/10W		R476			RK73GB2A000J	CHIP R 0 OHM J 1/10W	
R391			RK73EB2E000J	CHIP R 0 OHM J 1/4W		R477			RK73GB2A153J	CHIP R 15K J 1/10W	
R392			RK73GB2A273J	CHIP R 27K J 1/10W		R478			RK73GB2A682J	CHIP R 6.8K J 1/10W	
R393			RK73GB2A000J	CHIP R 0 OHM J 1/10W		R479			RK73GB2A681J	CHIP R 680 J 1/10W	
R394			RK73EB2E000J	CHIP R 0 OHM J 1/4W		R480			RK73GB2A101J	CHIP R 100 J 1/10W	
R395			RK73FB2B000J	CHIP R 0 OHM J 1/8W		R481-483			RK73GB2A000J	CHIP R 0 OHM J 1/10W	
R396-398			RK73GB2A000J	CHIP R 0 OHM J 1/10W		R484			RK73GB2A470J	CHIP R 47 J 1/10W	
R399			RK73FB2B100J	CHIP R 10 J 1/8W	E1,E2,E3	R485,486			RK73GB2A000J	CHIP R 0 OHM J 1/10W	
R399			RK73FB2B100J	CHIP R 10 J 1/8W	E4,E5,J	R487			RK73GB2A151J	CHIP R 150 J 1/10W	
R399			RK73FB2B100J	CHIP R 10 J 1/8W	J1,J2,J3	R488			RK73GB2A153J	CHIP R 15K J 1/10W	
R399	*		RK73FB2B6R8J	CHIP R 6.8 J 1/8W	K1,K2,K3	R489			RK73GB2A682J	CHIP R 6.8K J 1/10W	
R400-411			RK73GB2A101J	CHIP R 100 J 1/10W		R490			RK73GB2A000J	CHIP R 0 OHM J 1/10W	
R412-417			RK73GB2A000J	CHIP R 0 OHM J 1/10W		R491			RK73GB2A390J	CHIP R 39 J 1/10W	
R418			RK73GB2A101J	CHIP R 100 J 1/10W		R492			RK73GB2A000J	CHIP R 0 OHM J 1/10W	
R419			RK73GB2A102J	CHIP R 1.0K J 1/10W		R493			RK73GB2A151J	CHIP R 150 J 1/10W	
R420			RK73GB2A470J	CHIP R 47 J 1/10W		R494			RK73GB2A271J	CHIP R 270 J 1/10W	
R421			RK73GB2A102J	CHIP R 1.0K J 1/10W		R495			RK73GB2A103J	CHIP R 10K J 1/10W	
R422			RK73GB2A222J	CHIP R 2.2K J 1/10W		R496			RK73GB2A472J	CHIP R 4.7K J 1/10W	
R423			RK73GB2A000J	CHIP R 0 OHM J 1/10W		R497			RK73GB2A101J	CHIP R 100 J 1/10W	
R424			RK73GB2A101J	CHIP R 100 J 1/10W		R498			RK73GB2A822J	CHIP R 8.2K J 1/10W	
R427			RK73GB2A101J	CHIP R 100 J 1/10W		R499			RK73GB2A153J	CHIP R 15K J 1/10W	
R428-431			RK73GB2A123J	CHIP R 12K J 1/10W		R500			RK73GB2A472J	CHIP R 4.7K J 1/10W	
R432			RK73GB2A000J	CHIP R 0 OHM J 1/10W		R501			RK73GB2A153J	CHIP R 15K J 1/10W	
R433,434			RK73GB2A473J	CHIP R 47K J 1/10W		R502			RK73GB2A682J	CHIP R 6.8K J 1/10W	
R435			RK73GB2A474J	CHIP R 470K J 1/10W		R503			RK73GB2A181J	CHIP R 180 J 1/10W	
R436			RK73GB2A103J	CHIP R 10K J 1/10W		R504			RK73GB2A470J	CHIP R 47 J 1/10W	
R437			RK73GB2A332J	CHIP R 3.3K J 1/10W		R505			RK73GB2A391J	CHIP R 390 J 1/10W	
R438			RK73GB2A102J	CHIP R 1.0K J 1/10W		R506			RK73GB2A821J	CHIP R 820 J 1/10W	
R439,440			RK73GB2A220J	CHIP R 22 J 1/10W		R507			RK73GB2A121J	CHIP R 120 J 1/10W	
R441			RK73GB2A181J	CHIP R 180 J 1/10W		R508			RK73GB2A820J	CHIP R 82 J 1/10W	
R442			RK73GB2A102J	CHIP R 1.0K J 1/10W		R509			RK73GB2A5R6J	CHIP R 5.6 J 1/10W	
R443,444			RK73GB2A101J	CHIP R 100 J 1/10W		R510			RK73GB2A101J	CHIP R 100 J 1/10W	
R445			RK73GB2A682J	CHIP R 6.8K J 1/10W		R511			RK73GB2A821J	CHIP R 820 J 1/10W	

PARTS LIST

TX-RX 2 UNIT (X57-606X-XX)

Ref. No.	Address	New parts	Parts No.	Description	Desti-nation	Ref. No.	Address	New parts	Parts No.	Description	Desti-nation
R512			RK73GB2A470J	CHIP R 47 J 1/10W		R581			RK73GB2A682J	CHIP R 6.8K J 1/10W	
R513			RK73GB2A820J	CHIP R 82 J 1/10W		R583			RK73GB2A101J	CHIP R 100 J 1/10W	
R514,515			RK73GB2A000J	CHIP R 0 OHM J 1/10W		R585			RK73GB2A101J	CHIP R 100 J 1/10W	
R516			RK73GB2A101J	CHIP R 100 J 1/10W		R586			RK73GB2A472J	CHIP R 4.7K J 1/10W	
R517-519			RK73GB2A470J	CHIP R 47 J 1/10W		R587			RK73GB2A101J	CHIP R 100 J 1/10W	
R520,521			RK73GB2A823J	CHIP R 82K J 1/10W		R588			RK73GB2A470J	CHIP R 47 J 1/10W	
R522,523			RK73GB2A561J	CHIP R 560 J 1/10W		R589			RK73GB2A151J	CHIP R 150 J 1/10W	
R524			RK73GB2A823J	CHIP R 82K J 1/10W		R593			RK73GB2A682J	CHIP R 6.8K J 1/10W	
R525,526			RK73GB2A392J	CHIP R 3.9K J 1/10W		R596			RK73GB2A153J	CHIP R 15K J 1/10W	
R527			RK73GB2A561J	CHIP R 560 J 1/10W		R598			RK73GB2A271J	CHIP R 270 J 1/10W	
R528			RK73GB2A682J	CHIP R 6.8K J 1/10W		R600			RK73GB2A470J	CHIP R 47 J 1/10W	
R529,530			RK73GB2A101J	CHIP R 100 J 1/10W		R602			RK73GB2A151J	CHIP R 150 J 1/10W	
R531			RK73GB2A392J	CHIP R 3.9K J 1/10W		R603			RK73GB2A390J	CHIP R 39 J 1/10W	
R532			RK73GB2A470J	CHIP R 47 J 1/10W		R604-606			RK73GB2A101J	CHIP R 100 J 1/10W	
R533			RK73GB2A151J	CHIP R 150 J 1/10W		R604,605			RK73GB2A101J	CHIP R 100 J 1/10W	
R534			RK73GB2A682J	CHIP R 6.8K J 1/10W		R607			RK73GB2A182J	CHIP R 1.8K J 1/10W	
R535			RK73GB2A470J	CHIP R 47 J 1/10W		R608			RK73GB2A151J	CHIP R 150 J 1/10W	
R536			RK73GB2A153J	CHIP R 15K J 1/10W		R609			RK73GB2A101J	CHIP R 100 J 1/10W	
R537,538			RK73GB2A331J	CHIP R 330 J 1/10W		R610			RK73GB2A182J	CHIP R 1.8K J 1/10W	
R539			RK73GB2A271J	CHIP R 270 J 1/10W		R611			RK73GB2A222J	CHIP R 2.2K J 1/10W	
R540			RK73GB2A470J	CHIP R 47 J 1/10W		R612			RK73GB2A000J	CHIP R 0 OHM J 1/10W	
R541			RK73GB2A101J	CHIP R 100 J 1/10W		R613			RK73GB2A150J	CHIP R 15 J 1/10W	
R542			RK73GB2A822J	CHIP R 8.2K J 1/10W		R614			RK73GB2A222J	CHIP R 2.2K J 1/10W	
R543			RK73GB2A153J	CHIP R 15K J 1/10W		R615			RK73GB2A000J	CHIP R 0 OHM J 1/10W	
R544			RK73GB2A101J	CHIP R 100 J 1/10W		R616			RK73GB2A151J	CHIP R 150 J 1/10W	
R545			RK73GB2A822J	CHIP R 8.2K J 1/10W		R617			RK73GB2A472J	CHIP R 4.7K J 1/10W	
R546			RK73GB2A153J	CHIP R 15K J 1/10W		R618			RK73GB2A390J	CHIP R 39 J 1/10W	
R547,548			RK73GB2A391J	CHIP R 390 J 1/10W		R619,620			RK73GB2A101J	CHIP R 100 J 1/10W	
R549			RK73GB2A331J	CHIP R 330 J 1/10W		R621			RK73GB2A150J	CHIP R 15 J 1/10W	
R550			RK73GB2A221J	CHIP R 220 J 1/10W		R622			RK73GB2A101J	CHIP R 100 J 1/10W	
R551			RK73GB2A331J	CHIP R 330 J 1/10W		R623,624			RK73GB2A151J	CHIP R 150 J 1/10W	
R552			RK73GB2A221J	CHIP R 220 J 1/10W		R625			RK73GB2A000J	CHIP R 0 OHM J 1/10W	
R553			RK73GB2A331J	CHIP R 330 J 1/10W		R626			RK73GB2A474J	CHIP R 470K J 1/10W	
R554			RK73GB2A101J	CHIP R 100 J 1/10W		R627			RK73GB2A150J	CHIP R 15 J 1/10W	
R555			RK73GB2A822J	CHIP R 8.2K J 1/10W		R628			RK73GB2A000J	CHIP R 0 OHM J 1/10W	
R556			RK73GB2A153J	CHIP R 15K J 1/10W		R629			RK73GB2A474J	CHIP R 470K J 1/10W	
R557			RK73GB2A101J	CHIP R 100 J 1/10W		R630			RK73GB2A390J	CHIP R 39 J 1/10W	
R558			RK73GB2A181J	CHIP R 180 J 1/10W		R631			RK73GB2A102J	CHIP R 1.0K J 1/10W	
R559			RK73GB2A391J	CHIP R 390 J 1/10W		R632			RK73GB2A151J	CHIP R 150 J 1/10W	
R560			RK73GB2A153J	CHIP R 15K J 1/10W		R633,634			RK73GB2A150J	CHIP R 15 J 1/10W	
R561			RK73GB2A682J	CHIP R 6.8K J 1/10W		R635			RK73GB2A681J	CHIP R 680 J 1/10W	
R562			RK73GB2A331J	CHIP R 330 J 1/10W		R636			RK73GB2A271J	CHIP R 270 J 1/10W	
R563			RK73GB2A221J	CHIP R 220 J 1/10W		R637,638			RK73GB2A682J	CHIP R 6.8K J 1/10W	
R564			RK73GB2A271J	CHIP R 270 J 1/10W		R639			RK73GB2A681J	CHIP R 680 J 1/10W	
R565			RK73GB2A150J	CHIP R 15 J 1/10W		R640			RK73GB2A222J	CHIP R 2.2K J 1/10W	
R566			RK73GB2A221J	CHIP R 220 J 1/10W		R641			RK73GB2A470J	CHIP R 47 J 1/10W	
R567			RK73GB2A470J	CHIP R 47 J 1/10W		R642			RK73GB2A153J	CHIP R 15K J 1/10W	
R568			RK73GB2A181J	CHIP R 180 J 1/10W		R643			RK73GB2A682J	CHIP R 6.8K J 1/10W	
R569			RK73GB2A150J	CHIP R 15 J 1/10W		R644			RK73GB2A180J	CHIP R 18 J 1/10W	
R570			RK73GB2A000J	CHIP R 0 OHM J 1/10W		R645			RK73GB2A222J	CHIP R 2.2K J 1/10W	
R571			RK73GB2A153J	CHIP R 15K J 1/10W		R646			RK73GB2A271J	CHIP R 270 J 1/10W	
R572			RK73GB2A682J	CHIP R 6.8K J 1/10W		R647			RK73GB2A102J	CHIP R 1.0K J 1/10W	
R573			RK73GB2A101J	CHIP R 100 J 1/10W		R648			RK73GB2A471J	CHIP R 470 J 1/10W	
R574			RK73GB2A150J	CHIP R 15 J 1/10W		R649			RK73GB2A472J	CHIP R 4.7K J 1/10W	
R575			RK73GB2A000J	CHIP R 0 OHM J 1/10W		R650			RK73GB2A102J	CHIP R 1.0K J 1/10W	
R576			RK73GB2A470J	CHIP R 47 J 1/10W		R651			RK73GB2A391J	CHIP R 390 J 1/10W	
R577			RK73GB2A181J	CHIP R 180 J 1/10W		R652			RK73GB2A000J	CHIP R 0 OHM J 1/10W	
R578			RK73GB2A000J	CHIP R 0 OHM J 1/10W		R653			RK73GB2A391J	CHIP R 390 J 1/10W	
R579			RK73GB2A101J	CHIP R 100 J 1/10W		R654			RK73GB2A000J	CHIP R 0.0 J 1/10W	
R580			RK73GB2A000J	CHIP R 0 OHM J 1/10W		R654,655			RK73GB2A000J	CHIP R 0.0 J 1/10W	

J : TS-2000S J1 : TS-2000V J2 : TS-2000SX J3 : TS-2000VX
 K1 : TS-2000 (K) K2 : TS-B2000 (K) K3 : TS-2000X (K)
 E1 : TS-2000 (E) E2 : TS-B2000 (E) E3 : TS-2000 (E2) E4 : TS-B2000 (E2) E5 : TS-2000X (E)

PARTS LIST

TX-RX 2 UNIT (X57-606X-XX)

Ref. No.	Address	New parts	Parts No.	Description	Destination	Ref. No.	Address	New parts	Parts No.	Description	Destination
R656			RK73GB2A472J	CHIP R 4.7K J 1/10W		R755			RK73GB2A470J	CHIP R 47 J 1/10W	
R657			RK73GB2A153J	CHIP R 15K J 1/10W		R756			RK73GB2A153J	CHIP R 15K J 1/10W	
R658			RK73GB2A682J	CHIP R 6.8K J 1/10W		R757			RK73GB2A682J	CHIP R 6.8K J 1/10W	
R659,660			RK73GB2A102J	CHIP R 1.0K J 1/10W		R758			RK73GB2A102J	CHIP R 1.0K J 1/10W	
R661			RK73GB2A150J	CHIP R 15 J 1/10W		R759			RK73GB2A181J	CHIP R 180 J 1/10W	
R663			RK73GB2A471J	CHIP R 470 J 1/10W		R760-762			RK73GB2A102J	CHIP R 1.0K J 1/10W	
R664			RK73GB2A151J	CHIP R 150 J 1/10W		R763			RK73GB2A472J	CHIP R 4.7K J 1/10W	
R665			RK73GB2A102J	CHIP R 1.0K J 1/10W		R764,765			RK73GB2A102J	CHIP R 1.0K J 1/10W	
R666			RK73GB2A390J	CHIP R 39 J 1/10W		R766			RK73GB2A271J	CHIP R 270 J 1/10W	
R667			RK73GB2A150J	CHIP R 15 J 1/10W		R767			RK73GB2A180J	CHIP R 18 J 1/10W	
R668			RK73GB2A101J	CHIP R 100 J 1/10W		R768-770			RK73GB2A271J	CHIP R 270 J 1/10W	
R669			RK73GB2A150J	CHIP R 15 J 1/10W		R771,772			RK73GB2A180J	CHIP R 18 J 1/10W	
R670			RK73GB2A470J	CHIP R 47 J 1/10W		R773,774			RK73GB2A271J	CHIP R 270 J 1/10W	
R671			RK73GB2A151J	CHIP R 150 J 1/10W		R775			RK73GB2A000J	CHIP R 0 OHM J 1/10W	
R675			RK73GB2A391J	CHIP R 390 J 1/10W		D6,7			RN731V	DIODE	
R676			RK73GB2A151J	CHIP R 150 J 1/10W		D9-11			HSC277	DIODE	
R677			RK73GB2A101J	CHIP R 100 J 1/10W		D12			RN731V	DIODE	
R677,678			RK73GB2A101J	CHIP R 100 J 1/10W		D13			HSC277	DIODE	
R680			RK73GB2A390J	CHIP R 39 J 1/10W		D14			RN731V	DIODE	
R681-683			RK73GB2A000J	CHIP R 0 OHM J 1/10W		D15			HSC277	DIODE	
R685			RK73GB2A000J	CHIP R 0 OHM J 1/10W		D16			HVC131	DIODE	
R686			RK73GB2A151J	CHIP R 150 J 1/10W		D17			HSC277	DIODE	
R687			RK73GB2A000J	CHIP R 0 OHM J 1/10W		D18			HVC131	DIODE	
R689,690			RK73GB2A000J	CHIP R 0 OHM J 1/10W		D19			RN731V	DIODE	
R692			RK73GB2A101J	CHIP R 100 J 1/10W		D20			HSC277	DIODE	
R693			RK73GB2A102J	CHIP R 1.0K J 1/10W		D21			RN731V	DIODE	
R694			RK73GB2A153J	CHIP R 15K J 1/10W		D22-24			HSC277	DIODE	
R695			RK73GB2A682J	CHIP R 6.8K J 1/10W		D30-34			HVC350B	VARIABLE CAPACITANCE DIODE	
R696			RK73GB2A470J	CHIP R 47 J 1/10W		D36,37			HVC350B	VARIABLE CAPACITANCE DIODE	
R697			RK73GB2A121J	CHIP R 120 J 1/10W		D39-43			HVC350B	VARIABLE CAPACITANCE DIODE	
R698			RK73GB2A682J	CHIP R 6.8K J 1/10W		D46			DAN235E	DIODE	
R699			RK73GB2A391J	CHIP R 390 J 1/10W		D47			HVC350B	VARIABLE CAPACITANCE DIODE	
R700			RK73GB2A000J	CHIP R 0 OHM J 1/10W		D48,49			HSC277	DIODE	
R701			RK73GB2A102J	CHIP R 1.0K J 1/10W		D51			HVC350B	VARIABLE CAPACITANCE DIODE	
R702,703			RK73GB2A103J	CHIP R 10K J 1/10W		D52,53			DAN235E	DIODE	
R710-713			RK73GB2A472J	CHIP R 4.7K J 1/10W		D54			HSB88WS	DIODE	J,J1,J2
R714,715			RK73GB2A101J	CHIP R 100 J 1/10W		D56			DAN235E	DIODE	J3
R716-719			RK73GB2A102J	CHIP R 1.0K J 1/10W		D56			DAN235E	DIODE	K1,K2,K3
R720			RK73GB2A182J	CHIP R 1.8K J 1/10W		D56			DAN235E	DIODE	
R721			RK73GB2A000J	CHIP R 0 OHM J 1/10W		D56,57			DAN235E	DIODE	E1,E2,E3
R722,723			RK73GB2A101J	CHIP R 100 J 1/10W		D56,57			DAN235E	DIODE	E4,E5
R724,725			RK73GB2A102J	CHIP R 1.0K J 1/10W		D58			RB706F-40	DIODE	
R726			RK73GB2A101J	CHIP R 100 J 1/10W		D59			DAN235E	DIODE	E1,E2,E3
R727			RK73GB2A680J	CHIP R 68 J 1/10W		D59			DAN235E	DIODE	E4,E5
R728-731			RK73GB2A102J	CHIP R 1.0K J 1/10W		D63-66			1SS355	DIODE	
R732,733			RK73GB2A000J	CHIP R 0 OHM J 1/10W		D68			DAN222	DIODE	
R734			RK73GB2A101J	CHIP R 100 J 1/10W		D69			1SS355	DIODE	
R735,736			RK73GB2A391J	CHIP R 390 J 1/10W		D71			1SS355	DIODE	
R737			RK73GB2A103J	CHIP R 10K J 1/10W		D73,74			DAN222	DIODE	
R738			RK73GB2A120J	CHIP R 12 J 1/10W		D75,76			1SS355	DIODE	
R739,740			RK73GB2A472J	CHIP R 4.7K J 1/10W		D77,78			MA3J742	DIODE	
R741			RK73GB2A120J	CHIP R 12 J 1/10W		D79,80			HVC350B	VARIABLE CAPACITANCE DIODE	
R742,743			RK73GB2A472J	CHIP R 4.7K J 1/10W		D81,82			HVC131	DIODE	
R744			RK73GB2A271J	CHIP R 270 J 1/10W		D83			MA3J742	DIODE	
R745,746			RK73GB2A391J	CHIP R 390 J 1/10W		D84-88			HVC350B	VARIABLE CAPACITANCE DIODE	
R747			RK73GB2A180J	CHIP R 18 J 1/10W		D89			UDZS3.9B	ZENER DIODE	
R749,750			RK73GB2A102J	CHIP R 1.0K J 1/10W		D90,91			HSC277	DIODE	
R751			RK73GB2A271J	CHIP R 270 J 1/10W		D92-94			HVC131	DIODE	
R752			RK73GB2A102J	CHIP R 1.0K J 1/10W		D95			HSC277	DIODE	
R753,754			RK73GB2A000J	CHIP R 0 OHM J 1/10W							

PARTS LIST

TX-RX 2 UNIT (X57-606X-XX)

Ref. No.	Address	New parts	Parts No.	Description	Desti-nation	Ref. No.	Address	New parts	Parts No.	Description	Desti-nation
D96,97			HVC131	DIODE		Q37			3SK298	FET	
D98			DAN222	DIODE		Q38		*	3SK131-A(M)	FET	
D99			1SS355	DIODE		Q39			2SC4617(R)	TRANSISTOR	
D100			HVC350B	VARIABLE CAPACITANCE DIODE		Q40			DTA114EUA	DIGITAL TRANSISTOR	E1,E2,E3
D101			HSC277	DIODE		Q40			DTA114EUA	DIGITAL TRANSISTOR	E4,E5
D400			MA2S111-F	DIODE		Q41			DTC144EUA	DIGITAL TRANSISTOR	E1,E2,E3
D401,402		*	KV1460-G	VARIABLE CAPACITANCE DIODE		Q41			DTC144EUA	DIGITAL TRANSISTOR	E4,E5
D403			MA2S304	VARIABLE CAPACITANCE DIODE		Q42,43			2SK520(K43)	FET	J,J1,J2
D404,405			MA2S077-F	DIODE		Q42,43			2SK520(K43)	FET	J3
D406			MA2S304	VARIABLE CAPACITANCE DIODE		Q42,43			2SK520(K43)	FET	K1,K2,K3
D407			MA2S111-F	DIODE		Q42,43		*	2SK520-A(K43)	FET	E1,E2,E3
D408		*	KV1460-G	VARIABLE CAPACITANCE DIODE		Q42,43		*	2SK520-A(K43)	FET	E4,E5
D409-412			1SV283F	VARIABLE CAPACITANCE DIODE		Q44,45			2SC4617(R)	TRANSISTOR	
D413		*	KV1460-G	VARIABLE CAPACITANCE DIODE		Q46,47		*	3SK131-A(M)	FET	
D416,417			1SV283F	VARIABLE CAPACITANCE DIODE		Q48			2SC4617(R)	TRANSISTOR	
D418,419			MA2S077-F	DIODE		Q50,51			2SC4617(R)	TRANSISTOR	
D420			1SV283F	VARIABLE CAPACITANCE DIODE		Q55,56			2SB1132(Q,R)	TRANSISTOR	
D421			MA2S077-F	DIODE		Q57-60			DTC114EUA	DIGITAL TRANSISTOR	
D422,423			MA2S111-F	DIODE		Q61		*	2SC3356-A	TRANSISTOR	
D426-429			RN731V	DIODE		Q62			2SA1362-F(Y)	TRANSISTOR	
D430-437			MA2S077-F	DIODE		Q63			2SC4617(S)	TRANSISTOR	
D438			MA2S111-F	DIODE		Q65			2SC4617(R)	TRANSISTOR	
D439-444			MA2S077-F	DIODE		Q66		*	FMA1A	TRANSISTOR	
D445-447			MA2S111-F	DIODE		Q67			DTA114EUA	DIGITAL TRANSISTOR	
IC2			BU2099FV	IC (SERIAL/PARALLEL SIGNAL CONVERSION)		Q400-402			2SC3722K(R)	TRANSISTOR	
IC3		*	UPC1678GV-A	IC (WIDE BAND AMPLIFIER)		Q403-405			DTC114EUA	DIGITAL TRANSISTOR	
IC4,5			SPM5001	IC (MIXER)		Q406,407			2SK508NV(K52)	FET	
IC6			UPB1509GV	IC (DIVIDER)		Q409			2SK508NV(K52)	FET	
IC7			TA31136FNG	IC (FM IC)		Q410,411			2SC4116(YF)	TRANSISTOR	
IC8		*	TC4W53FU-F	IC (MULTIPLEXER)		Q412			2SC4617(R)	TRANSISTOR	
IC9			NJM2904V-ZB	IC (OP AMP)		Q413,414			2SC5108(YF)	TRANSISTOR	
IC400			TA7808FQ	IC (AVR)		Q415			2SC4649(N,P)	TRANSISTOR	
IC401		*	LMX2306TMX/NP	IC (PLL)		Q416			2SC5108(YF)	TRANSISTOR	
IC402			LMX2316TMX	IC (PLL)		Q417-420			2SC4617(R)	TRANSISTOR	
IC403			TA7805FQ	IC (AVR)		Q421			2SC4649(N,P)	TRANSISTOR	
IC404			BU4094BCFV	IC (SERIAL/PARALLEL CONVERSION)		Q423-425			2SC4617(R)	TRANSISTOR	
IC405		*	UPC2709TB-A	IC (WIDE BAND AMPLIFIER)		Q426			DTC114EUA	DIGITAL TRANSISTOR	
IC406-408			AD9835BRUZ	IC (DDS)		Q427			2SK508NV(K52)	FET	
IC409-412		*	LMX2306TMX/NP	IC (PLL)		Q428			2SC4617(R)	TRANSISTOR	
IC414		*	LMX2306TMX/NP	IC (PLL)		Q428-430			2SC4617(R)	TRANSISTOR	
IC415,416		*	UPC2709TB-A	IC (WIDE BAND AMPLIFIER)		Q431			2SK508NV(K52)	FET	
Q1,2			DTC114EUA	DIGITAL TRANSISTOR		Q432			2SC4617(R)	TRANSISTOR	
Q3			FMA5	TRANSISTOR		Q433			2SK508NV(K52)	FET	
Q11			UMC2N	TRANSISTOR		Q434			DTC114EUA	DIGITAL TRANSISTOR	
Q13			FMA5	TRANSISTOR		Q435			2SC5108(YF)	TRANSISTOR	
Q14		*	NE34018	FET		Q436			DTC114EUA	DIGITAL TRANSISTOR	
Q15			3SK293-F	FET		Q437			2SC5108(YF)	TRANSISTOR	
Q16			UMC2N	TRANSISTOR		Q438			2SC4617(R)	TRANSISTOR	
Q17,18		*	2SC3356-A	TRANSISTOR		Q439			DTC114EUA	DIGITAL TRANSISTOR	
Q19			2SC5066-F(O)	TRANSISTOR		Q441			2SK508NV(K52)	FET	
Q20		*	2SK302-F(GR)	FET		Q444			2SC4617(R)	TRANSISTOR	
Q21,22			2SC3357-A	TRANSISTOR		Q446			2SC4617(R)	TRANSISTOR	
Q23			3SK298	FET		Q447-452			2SC3722K(R)	TRANSISTOR	
Q24,25			2SC3357-A	TRANSISTOR		Q453,454			DTC114EUA	DIGITAL TRANSISTOR	
Q26		*	2SC3356-A	TRANSISTOR		Q455			2SC4617(R)	TRANSISTOR	
Q30		*	2SC3356-A	TRANSISTOR		Q457			2SC5108(YF)	TRANSISTOR	
Q31			UMC2N	TRANSISTOR		Q458			2SC4617(R)	TRANSISTOR	
Q32-34		*	2SC3356-A	TRANSISTOR		Q459,460			2SK508NV(K52)	FET	
Q35			DTA114EUA	DIGITAL TRANSISTOR		Q461			2SC5108(YF)	TRANSISTOR	
Q36			UMC2N	TRANSISTOR		Q462			2SC4649(N,P)	TRANSISTOR	

J : TS-2000S J1 : TS-2000V J2 : TS-2000SX J3 : TS-2000VX
 K1 : TS-2000 (K) K2 : TS-B2000 (K) K3 : TS-2000X (K)
 E1 : TS-2000 (E) E2 : TS-B2000 (E) E3 : TS-2000 (E2) E4 : TS-B2000 (E2) E5 : TS-2000X (E)

PARTS LIST

TX-RX 2 UNIT (X57-606X-XX)
TX-RX 3 UNIT (UT-20) (X57-607X-XX)

Ref. No.	Address	New parts	Parts No.	Description	Destination
Q463			DTC114EUA	DIGITAL TRANSISTOR	
Q464			2SK508N(K52)	FET	
Q469-472			UMC2N	TRANSISTOR	
Q473			2SC4617(R)	TRANSISTOR	
Q474			UMC2N	TRANSISTOR	
Q476			2SC4649(N,P)	TRANSISTOR	
TH1			157-502-65001	THERMISTOR	
TH2			157-102-65001	THERMISTOR	

TX-RX 3 UNIT (UT-20) (X57-607X-XX)
0-00 : J2,J3,K3 2-71 : E5

C1			CK73GB1H103K	CHIP C	0.010UF	K	J3
C1			CK73GB1H103K	CHIP C	0.010UF	K	K3,E5,J2
C2			CK73GB1H471K	CHIP C	470PF	K	J3
C2			CK73GB1H471K	CHIP C	470PF	K	K3,E5,J2
C3			CC73GCH1H470J	CHIP C	47PF	J	J3
C3			CC73GCH1H470J	CHIP C	47PF	J	K3,E5,J2
C4			CK73GB1H103K	CHIP C	0.010UF	K	J3
C4			CK73GB1H103K	CHIP C	0.010UF	K	K3,E5,J2
C5,6			CC73GCH1H100D	CHIP C	10PF	D	J3
C5,6			CC73GCH1H100D	CHIP C	10PF	D	K3,E5,J2
C7			CK73GB1H102K	CHIP C	1000PF	K	J3
C7			CK73GB1H102K	CHIP C	1000PF	K	K3,E5,J2
C8			CK73GB1H103K	CHIP C	0.010UF	K	J3
C8			CK73GB1H103K	CHIP C	0.010UF	K	K3,E5,J2
C9			CC73GCH1H100D	CHIP C	10PF	D	J3
C9			CC73GCH1H100D	CHIP C	10PF	D	K3,E5,J2
C10			CK73GB1H102K	CHIP C	1000PF	K	J3
C10			CK73GB1H102K	CHIP C	1000PF	K	K3,E5,J2
C11,12			CK73GB1H103K	CHIP C	0.010UF	K	J3
C11,12			CK73GB1H103K	CHIP C	0.010UF	K	K3,E5,J2
C13			CC73GCH1H050C	CHIP C	5.0PF	C	J3
C13			CC73GCH1H050C	CHIP C	5.0PF	C	K3,E5,J2
C14,15			CK73GB1H102K	CHIP C	1000PF	K	J3
C14,15			CK73GB1H102K	CHIP C	1000PF	K	K3,E5,J2
C16			CK73GB1H471K	CHIP C	470PF	K	J3
C16			CK73GB1H471K	CHIP C	470PF	K	K3,E5,J2
C18			CC73GCH1H470J	CHIP C	47PF	J	J3
C18			CC73GCH1H470J	CHIP C	47PF	J	K3,E5,J2
C19			CC73GCH1H060D	CHIP C	6.0PF	D	J3
C19			CC73GCH1H060D	CHIP C	6.0PF	D	K3,E5,J2
C20,21			CK73GB1H102K	CHIP C	1000PF	K	J3
C20,21			CK73GB1H102K	CHIP C	1000PF	K	K3,E5,J2
C22			CC73GCH1H470J	CHIP C	47PF	J	J3
C22			CC73GCH1H470J	CHIP C	47PF	J	K3,E5,J2
C24			CC73GCH1H220J	CHIP C	22PF	J	J3
C24			CC73GCH1H220J	CHIP C	22PF	J	K3,E5,J2
C25			CC73GCH1H470J	CHIP C	47PF	J	J3
C25			CC73GCH1H470J	CHIP C	47PF	J	K3,E5,J2
C26			CC73GCH1H030C	CHIP C	3.0PF	C	J3
C26			CC73GCH1H030C	CHIP C	3.0PF	C	K3,E5,J2
C27,28			CC73GCH1H470J	CHIP C	47PF	J	J3
C27,28			CC73GCH1H470J	CHIP C	47PF	J	K3,E5,J2
C29			CK73GB1H471K	CHIP C	470PF	K	J3
C29			CK73GB1H471K	CHIP C	470PF	K	K3,E5,J2
C32			CK73GB1H471K	CHIP C	470PF	K	J3

Ref. No.	Address	New parts	Parts No.	Description	Destination		
C32			CK73GB1H471K	CHIP C	470PF	K	K3,E5,J2
C33,34			CC73GCH1H470J	CHIP C	47PF	J	J3
C33,34			CC73GCH1H470J	CHIP C	47PF	J	K3,E5,J2
C36			CK73GB1C104K	CHIP C	0.10UF	K	J3
C36			CK73GB1C104K	CHIP C	0.10UF	K	K3,E5,J2
C37			CC73GCH1H030C	CHIP C	3.0PF	C	J3
C37			CC73GCH1H030C	CHIP C	3.0PF	C	K3,E5,J2
C38			CK73GB1H471K	CHIP C	470PF	K	J3
C38			CK73GB1H471K	CHIP C	470PF	K	K3,E5,J2
C40			CC73GCH1H470J	CHIP C	47PF	J	J3
C40			CC73GCH1H470J	CHIP C	47PF	J	K3,E5,J2
C41			CK73GB1H102K	CHIP C	1000PF	K	J3
C41			CK73GB1H102K	CHIP C	1000PF	K	K3,E5,J2
C42			CE32BM1E470M	CHIP EL	47UF	25WV	J3
C42			CE32BM1E470M	CHIP EL	47UF	25WV	K3,E5,J2
C43			CK73GB1H102K	CHIP C	1000PF	K	J3
C43			CK73GB1H102K	CHIP C	1000PF	K	K3,E5,J2
C44			CE32BM1E470M	CHIP EL	47UF	25WV	J3
C44			CE32BM1E470M	CHIP EL	47UF	25WV	K3,E5,J2
C45			CK73GB1H102K	CHIP C	1000PF	K	J3
C45			CK73GB1H102K	CHIP C	1000PF	K	K3,E5,J2
C46			CC73GCH1H470J	CHIP C	47PF	J	J3
C46			CC73GCH1H470J	CHIP C	47PF	J	K3,E5,J2
C48			CK73GB1H471K	CHIP C	470PF	K	J3
C48			CK73GB1H471K	CHIP C	470PF	K	K3,E5,J2
C49			CE32BM1E470M	CHIP EL	47UF	25WV	J3
C49			CE32BM1E470M	CHIP EL	47UF	25WV	K3,E5,J2
C51			CK73GB1H102K	CHIP C	1000PF	K	J3
C51			CK73GB1H102K	CHIP C	1000PF	K	K3,E5,J2
C52			CC73GCH1H470J	CHIP C	47PF	J	J3
C52			CC73GCH1H470J	CHIP C	47PF	J	K3,E5,J2
C53			CK73GB1H471K	CHIP C	470PF	K	J3
C53			CK73GB1H471K	CHIP C	470PF	K	K3,E5,J2
C54			CE32BM1E470M	CHIP EL	47UF	25WV	J3
C54			CE32BM1E470M	CHIP EL	47UF	25WV	K3,E5,J2
C55			CK73GB1H102K	CHIP C	1000PF	K	J3
C55			CK73GB1H102K	CHIP C	1000PF	K	K3,E5,J2
C56			CC73GCH1H470J	CHIP C	47PF	J	J3
C56			CC73GCH1H470J	CHIP C	47PF	J	K3,E5,J2
C57			CK73GB1H471K	CHIP C	470PF	K	J3
C57			CK73GB1H471K	CHIP C	470PF	K	K3,E5,J2
C58			CE32BM1E470M	CHIP EL	47UF	25WV	J3
C58			CE32BM1E470M	CHIP EL	47UF	25WV	K3,E5,J2
C59			CK73GB1H471K	CHIP C	470PF	K	J3
C59			CK73GB1H471K	CHIP C	470PF	K	K3,E5,J2
C60			CK73GB1H102K	CHIP C	1000PF	K	J3
C60			CK73GB1H102K	CHIP C	1000PF	K	K3,E5,J2
C61			CC73GCH1H470J	CHIP C	47PF	J	J3
C61			CC73GCH1H470J	CHIP C	47PF	J	K3,E5,J2
C63		*	C90-4135-05	ELECTRO	100UF	25WV	J3
C63		*	C90-4135-05	ELECTRO	100UF	25WV	K3,E5,J2
C64			CK73GB1H471K	CHIP C	470PF	K	J3
C64			CK73GB1H471K	CHIP C	470PF	K	K3,E5,J2
C65			CC73GCH1H470J	CHIP C	47PF	J	J3
C65			CC73GCH1H470J	CHIP C	47PF	J	K3,E5,J2
C66			CC73GCH1H100D	CHIP C	10PF	D	J3
C66			CC73GCH1H100D	CHIP C	10PF	D	K3,E5,J2
C67			CC73GCH1H470J	CHIP C	47PF	J	J3
C67			CC73GCH1H470J	CHIP C	47PF	J	K3,E5,J2
C68			CC73GCH1H100D	CHIP C	10PF	D	J3

PARTS LIST

TX-RX 3 UNIT (UT-20) (X57-607X-XX)

Ref. No.	Address	New parts	Parts No.	Description	Desti-nation	Ref. No.	Address	New parts	Parts No.	Description	Desti-nation
C68			CC73GCH1H100D	CHIP C 10PF D	K3,E5,J2	C116			CC73GCH1H040C	CHIP C 4.0PF C	K3,E5,J2
C69,70			CC73GCH1H470J	CHIP C 47PF J	J3	C117			CC73GCH1H470J	CHIP C 47PF J	J3
C69,70			CC73GCH1H470J	CHIP C 47PF J	K3,E5,J2	C117			CC73GCH1H470J	CHIP C 47PF J	K3,E5,J2
C71			CK73GB1H471K	CHIP C 470PF K	J3	C118			CC73GCH1H101J	CHIP C 100PF J	J3
C71			CK73GB1H471K	CHIP C 470PF K	K3,E5,J2	C118			CC73GCH1H101J	CHIP C 100PF J	K3,E5,J2
C72			CC73GCH1H470J	CHIP C 47PF J	J3	C119			CK73GB1H103K	CHIP C 0.010UF K	J3
C72			CC73GCH1H470J	CHIP C 47PF J	K3,E5,J2	C119			CK73GB1H103K	CHIP C 0.010UF K	K3,E5,J2
C74			CK73GB1H471K	CHIP C 470PF K	J3	C120			CC73GCH1H470J	CHIP C 47PF J	J3
C74			CK73GB1H471K	CHIP C 470PF K	K3,E5,J2	C120			CC73GCH1H470J	CHIP C 47PF J	K3,E5,J2
C75			CM73F2H470J	CHIP C 47PF J	J3	C121,122			CK73GB1H471K	CHIP C 470PF K	J3
C75			CM73F2H470J	CHIP C 47PF J	K3,E5,J2	C121,122			CK73GB1H471K	CHIP C 470PF K	K3,E5,J2
C76			CK73GB1H471K	CHIP C 470PF K	J3	C123			CC73GCH1H470J	CHIP C 47PF J	J3
C76			CK73GB1H471K	CHIP C 470PF K	K3,E5,J2	C123			CC73GCH1H470J	CHIP C 47PF J	K3,E5,J2
C78			CC73GCH1H470J	CHIP C 47PF J	J3	C124			CC73GCH1H070B	CHIP C 7.0PF B	J3
C78			CC73GCH1H470J	CHIP C 47PF J	K3,E5,J2	C124			CC73GCH1H070B	CHIP C 7.0PF B	K3,E5,J2
C79-83			CC73GCH1H101J	CHIP C 100PF J	J3	C125			CC73GCH1H1R5B	CHIP C 1.5PF B	J3
C79-83			CC73GCH1H101J	CHIP C 100PF J	K3,E5,J2	C125			CC73GCH1H1R5B	CHIP C 1.5PF B	K3,E5,J2
C84-90			CK73GB1H103K	CHIP C 0.010UF K	J3	C126			CC73GCH1H080D	CHIP C 8.0PF D	J3
C84-90			CK73GB1H103K	CHIP C 0.010UF K	K3,E5,J2	C126			CC73GCH1H080D	CHIP C 8.0PF D	K3,E5,J2
C91			CK73GB1H102K	CHIP C 1000PF K	J3	C127			CC73GCH1H010B	CHIP C 1.0PF B	J3
C91			CK73GB1H102K	CHIP C 1000PF K	K3,E5,J2	C127			CC73GCH1H010B	CHIP C 1.0PF B	K3,E5,J2
C92			CC73GCH1H070D	CHIP C 7.0PF D	J3	C128			CC73GCH1H1R5B	CHIP C 1.5PF B	J3
C92			CC73GCH1H070D	CHIP C 7.0PF D	K3,E5,J2	C128			CC73GCH1H1R5B	CHIP C 1.5PF B	K3,E5,J2
C93			CK73GB1H102K	CHIP C 1000PF K	J3	C131-134			CC73GCH1H101J	CHIP C 100PF J	J3
C93			CK73GB1H102K	CHIP C 1000PF K	K3,E5,J2	C131-134			CC73GCH1H101J	CHIP C 100PF J	K3,E5,J2
C94			CC73GCH1H050C	CHIP C 5.0PF C	J3	C135			CC73GCH1H470J	CHIP C 47PF J	J3
C94			CC73GCH1H050C	CHIP C 5.0PF C	K3,E5,J2	C135			CC73GCH1H470J	CHIP C 47PF J	K3,E5,J2
C95			CC73GCH1H010B	CHIP C 1.0PF B	J3	C136			CK73GB1H103K	CHIP C 0.010UF K	J3
C95			CC73GCH1H010B	CHIP C 1.0PF B	K3,E5,J2	C136			CK73GB1H103K	CHIP C 0.010UF K	K3,E5,J2
C96,97			CK73GB1H102K	CHIP C 1000PF K	J3	C137		*	CS77AC1C100M	CHIP TNTL 100UF 10WV	J3
C96,97			CK73GB1H102K	CHIP C 1000PF K	K3,E5,J2	C137		*	CS77AC1C100M	CHIP TNTL 100UF 10WV	K3,E5,J2
C98			CK73GB1C104K	CHIP C 0.10UF K	J3	C138			CK73GB1H103K	CHIP C 0.010UF K	J3
C98			CK73GB1C104K	CHIP C 0.10UF K	K3,E5,J2	C138			CK73GB1H103K	CHIP C 0.010UF K	K3,E5,J2
C99			CK73GB1H102K	CHIP C 1000PF K	J3	C139,140			CK73GB1H102K	CHIP C 1000PF K	J3
C99			CK73GB1H102K	CHIP C 1000PF K	K3,E5,J2	C139,140			CK73GB1H102K	CHIP C 1000PF K	K3,E5,J2
C101			CC73GCH1H020B	CHIP C 2.0PF B	J3	C142			CC73GCH1H070D	CHIP C 7.0PF D	J3
C101			CC73GCH1H020B	CHIP C 2.0PF B	K3,E5,J2	C142			CC73GCH1H070D	CHIP C 7.0PF D	K3,E5,J2
C103			CC73GCH1H010B	CHIP C 1.0PF B	J3	C143			CK73GB1H102K	CHIP C 1000PF K	J3
C103			CC73GCH1H010B	CHIP C 1.0PF B	K3,E5,J2	C143			CK73GB1H102K	CHIP C 1000PF K	K3,E5,J2
C104			CK73GB1H471K	CHIP C 470PF K	J3	C144			CC73GCH1H0R3B	CHIP C 0.3PF B	J3
C104			CK73GB1H471K	CHIP C 470PF K	K3,E5,J2	C144			CC73GCH1H0R3B	CHIP C 0.3PF B	K3,E5,J2
C105			CC73GCH1H470J	CHIP C 47PF J	J3	C145			CC73GCH1H070D	CHIP C 7.0PF D	J3
C105			CC73GCH1H470J	CHIP C 47PF J	K3,E5,J2	C145			CC73GCH1H070D	CHIP C 7.0PF D	K3,E5,J2
C106			CC73GCH1H060D	CHIP C 6.0PF D	J3	C147		*	CS77AC1C100M	CHIP TNTL 100UF 10WV	J3
C106			CC73GCH1H060D	CHIP C 6.0PF D	K3,E5,J2	C147		*	CS77AC1C100M	CHIP TNTL 100UF 10WV	K3,E5,J2
C107			CC73GCH1H470J	CHIP C 47PF J	J3	C148			CK73GB1H103K	CHIP C 0.010UF K	J3
C107			CC73GCH1H470J	CHIP C 47PF J	K3,E5,J2	C148			CK73GB1H103K	CHIP C 0.010UF K	K3,E5,J2
C108			CK73GB1H471K	CHIP C 470PF K	J3	C149			CK73GB1H102K	CHIP C 1000PF K	J3
C108			CK73GB1H471K	CHIP C 470PF K	K3,E5,J2	C149			CK73GB1H102K	CHIP C 1000PF K	K3,E5,J2
C110			CC73GCH1HR75B	CHIP C 0.75PF B	J3	C150			CC73GCH1H470J	CHIP C 47PF J	J3
C110			CC73GCH1HR75B	CHIP C 0.75PF B	K3,E5,J2	C150			CC73GCH1H470J	CHIP C 47PF J	K3,E5,J2
C111			CK73GB1H471K	CHIP C 470PF K	J3	C151			CK73GB1H103K	CHIP C 0.010UF K	J3
C111			CK73GB1H471K	CHIP C 470PF K	K3,E5,J2	C151			CK73GB1H103K	CHIP C 0.010UF K	K3,E5,J2
C112			CC73GCH1H101J	CHIP C 100PF J	J3	C152			CK73GB1H102K	CHIP C 1000PF K	J3
C112			CC73GCH1H101J	CHIP C 100PF J	K3,E5,J2	C152			CK73GB1H102K	CHIP C 1000PF K	K3,E5,J2
C113			CC73GCH1H020B	CHIP C 2.0PF B	J3	C153			CC73GCH1H070D	CHIP C 7.0PF D	J3
C113			CC73GCH1H020B	CHIP C 2.0PF B	K3,E5,J2	C153			CC73GCH1H070D	CHIP C 7.0PF D	K3,E5,J2
C114			CC73GCH1H220J	CHIP C 22PF J	J3	C154			CK73GB1H102K	CHIP C 1000PF K	J3
C114			CC73GCH1H220J	CHIP C 22PF J	K3,E5,J2	C154			CK73GB1H102K	CHIP C 1000PF K	K3,E5,J2
C116			CC73GCH1H040C	CHIP C 4.0PF C	J3	C155,156			CK73GB1H103K	CHIP C 0.010UF K	J3

J : TS-2000S J1 : TS-2000V J2 : TS-2000SX J3 : TS-2000VX

K1 : TS-2000 (K) K2 : TS-B2000 (K) K3 : TS-2000X (K)

E1 : TS-2000 (E) E2 : TS-B2000 (E) E3 : TS-2000 (E2) E4 : TS-B2000 (E2) E5 : TS-2000X (E)

PARTS LIST

TX-RX 3 UNIT (UT-20) (X57-607X-XX)

Ref. No.	Address	New parts	Parts No.	Description	Destination	Ref. No.	Address	New parts	Parts No.	Description	Destination
C155,156			CK73GB1H103K	CHIP C 0.010UF K	K3,E5,J2	C307			CC73GCH1H1R5B	CHIP C 1.5PF B	K3,E5,J2
C158			CC73GCH1H470J	CHIP C 47PF J	J3	C308			CK73GB1H471K	CHIP C 470PF K	J3
C158			CC73GCH1H470J	CHIP C 47PF J	K3,E5,J2	C308			CK73GB1H471K	CHIP C 470PF K	K3,E5,J2
C165			C92-0523-05	CHIP-ELE 10UF 16WV	J3	C309			CC73GCH1H060D	CHIP C 6.0PF D	J3
C165			C92-0523-05	CHIP-ELE 10UF 16WV	K3,E5,J2	C309			CC73GCH1H060D	CHIP C 6.0PF D	K3,E5,J2
C167			CK73GB1H102K	CHIP C 1000PF K	J3	C310			CC73GCH1H101J	CHIP C 100PF J	J3
C167			CK73GB1H102K	CHIP C 1000PF K	K3,E5,J2	C310			CC73GCH1H101J	CHIP C 100PF J	K3,E5,J2
C169			CK73GB1H471K	CHIP C 470PF K	J3	C311			CC73GCH1H080D	CHIP C 8.0PF D	J3
C169			CK73GB1H471K	CHIP C 470PF K	K3,E5,J2	C311			CC73GCH1H080D	CHIP C 8.0PF D	K3,E5,J2
C170,171			CK73GB1H102K	CHIP C 1000PF K	J3	C312			CC73GCH1H020B	CHIP C 2.0PF B	J3
C170,171			CK73GB1H102K	CHIP C 1000PF K	K3,E5,J2	C312			CC73GCH1H020B	CHIP C 2.0PF B	K3,E5,J2
C172			CK73GB1H103K	CHIP C 0.010UF K	J3	C313			CC73GCH1H030C	CHIP C 3.0PF C	J3
C172			CK73GB1H103K	CHIP C 0.010UF K	K3,E5,J2	C313			CC73GCH1H030C	CHIP C 3.0PF C	K3,E5,J2
C173			CK73GB1H102K	CHIP C 1000PF K	J3	C314			CC73GCH1H101J	CHIP C 100PF J	J3
C173			CK73GB1H102K	CHIP C 1000PF K	K3,E5,J2	C314			CC73GCH1H101J	CHIP C 100PF J	K3,E5,J2
C174			CK73GB1H471K	CHIP C 470PF K	J3	C315			CC73GCH1H470J	CHIP C 47PF J	J3
C174			CK73GB1H471K	CHIP C 470PF K	K3,E5,J2	C315			CC73GCH1H470J	CHIP C 47PF J	K3,E5,J2
C176			CE32BM1E470M	CHIP EL 47UF 25WV	J3	C316			CC73GCH1H030C	CHIP C 3.0PF C	J3
C176			CE32BM1E470M	CHIP EL 47UF 25WV	K3,E5,J2	C316			CC73GCH1H030C	CHIP C 3.0PF C	K3,E5,J2
C178			CK73GB1H102K	CHIP C 1000PF K	J3	C317,318			CC73GCH1H010B	CHIP C 1.0PF B	J3
C178			CK73GB1H102K	CHIP C 1000PF K	K3,E5,J2	C317,318			CC73GCH1H010B	CHIP C 1.0PF B	K3,E5,J2
C179			C92-0523-05	CHIP-ELE 10UF 16WV	J3	C319			CC73GCH1H470J	CHIP C 47PF J	J3
C179			C92-0523-05	CHIP-ELE 10UF 16WV	K3,E5,J2	C319			CC73GCH1H470J	CHIP C 47PF J	K3,E5,J2
C180			CK73GB1H102K	CHIP C 1000PF K	J3	C320			C92-0836-05	ELECTRO 330UF 16WV	J3
C180			CK73GB1H102K	CHIP C 1000PF K	K3,E5,J2	C320			C92-0836-05	ELECTRO 330UF 16WV	K3,E5,J2
C182			CC73GCH1H470J	CHIP C 47PF J	J3	C323			CC73GCH1H470J	CHIP C 47PF J	J3
C182			CC73GCH1H470J	CHIP C 47PF J	K3,E5,J2	C323			CC73GCH1H470J	CHIP C 47PF J	K3,E5,J2
C183			CK73GB1H471K	CHIP C 470PF K	J3	C326,327			CC73GCH1H470J	CHIP C 47PF J	J3
C183			CK73GB1H471K	CHIP C 470PF K	K3,E5,J2	C326,327			CC73GCH1H470J	CHIP C 47PF J	K3,E5,J2
C184,185			CC73GCH1H470J	CHIP C 47PF J	J3	C328,329			CK73GB1H103K	CHIP C 0.010UF K	J3
C184,185			CC73GCH1H470J	CHIP C 47PF J	K3,E5,J2	C328,329			CK73GB1H103K	CHIP C 0.010UF K	K3,E5,J2
C186			CK73GB1H471K	CHIP C 470PF K	J3	C332			CK73GB1C473K	CHIP C 0.047UF K	J3
C186			CK73GB1H471K	CHIP C 470PF K	K3,E5,J2	C332			CK73GB1C473K	CHIP C 0.047UF K	K3,E5,J2
C188			CC73GCH1H040C	CHIP C 4.0PF C	J3	C333,334			CS77CA1A3R3M	CHIP TNTL 3.3UF 10WV	J3
C188			CC73GCH1H040C	CHIP C 4.0PF C	K3,E5,J2	C333,334			CS77CA1A3R3M	CHIP TNTL 3.3UF 10WV	K3,E5,J2
C189			CC73GCH1H220J	CHIP C 22PF J	J3	C335		*	C92-0872-05	CHIP TNTL 0.068UF 35WV	J3
C189			CC73GCH1H220J	CHIP C 22PF J	K3,E5,J2	C335		*	C92-0872-05	CHIP TNTL 0.068UF 35WV	K3,E5,J2
C190			CC73GCH1H470J	CHIP C 47PF J	J3	C336			CK73GB1H182K	CHIP C 1800PF K	J3
C190			CC73GCH1H470J	CHIP C 47PF J	K3,E5,J2	C336			CK73GB1H182K	CHIP C 1800PF K	K3,E5,J2
C191			CC73GCH1H050C	CHIP C 5.0PF C	J3	C367			CC73GCH1H101J	CHIP C 100PF J	J3
C191			CC73GCH1H050C	CHIP C 5.0PF C	K3,E5,J2	C367			CC73GCH1H101J	CHIP C 100PF J	K3,E5,J2
C192			CK73GB1H471K	CHIP C 470PF K	J3	C368,369			CC73GCH1H020B	CHIP C 2.0PF B	J3
C192			CK73GB1H471K	CHIP C 470PF K	K3,E5,J2	C368,369			CC73GCH1H020B	CHIP C 2.0PF B	K3,E5,J2
C193			CC73GCH1H100D	CHIP C 10PF D	J3	C370-374			CK73GB1H103K	CHIP C 0.010UF K	J3
C193			CC73GCH1H100D	CHIP C 10PF D	K3,E5,J2	C370-374			CK73GB1H103K	CHIP C 0.010UF K	K3,E5,J2
C194			CK73GB1H103K	CHIP C 0.010UF K	J3	C377-379			CK73GB1H103K	CHIP C 0.010UF K	J3
C194			CK73GB1H103K	CHIP C 0.010UF K	K3,E5,J2	C377-379			CK73GB1H103K	CHIP C 0.010UF K	K3,E5,J2
C195			CC73GCH1H101J	CHIP C 100PF J	J3	C380			CC73GCH1H270J	CHIP C 27PF J	J3
C195			CC73GCH1H101J	CHIP C 100PF J	K3,E5,J2	C380			CC73GCH1H270J	CHIP C 27PF J	K3,E5,J2
C301			CK73GB1H471K	CHIP C 470PF K	J3	C381,382			CK73GB1H103K	CHIP C 0.010UF K	J3
C301			CK73GB1H471K	CHIP C 470PF K	K3,E5,J2	C381,382			CK73GB1H103K	CHIP C 0.010UF K	K3,E5,J2
C302,303			CC73GCH1H101J	CHIP C 100PF J	J3	C383			CC73GCH1H080D	CHIP C 8.0PF D	J3
C302,303			CC73GCH1H101J	CHIP C 100PF J	K3,E5,J2	C383			CC73GCH1H080D	CHIP C 8.0PF D	K3,E5,J2
C304			CC73GCH1H150J	CHIP C 15PF J	J3	C384-386			CK73GB1H103K	CHIP C 0.010UF K	J3
C304			CC73GCH1H150J	CHIP C 15PF J	K3,E5,J2	C384-386			CK73GB1H103K	CHIP C 0.010UF K	K3,E5,J2
C305			CK73GB1H102K	CHIP C 1000PF K	J3	C387			CK73GB1C104K	CHIP C 0.10UF K	J3
C305			CK73GB1H102K	CHIP C 1000PF K	K3,E5,J2	C387			CK73GB1C104K	CHIP C 0.10UF K	K3,E5,J2
C306			CC73GCH1H150J	CHIP C 15PF J	J3	C388			CC73GCH1H330J	CHIP C 33PF J	J3
C306			CC73GCH1H150J	CHIP C 15PF J	K3,E5,J2	C388			CC73GCH1H330J	CHIP C 33PF J	K3,E5,J2
C307			CC73GCH1H1R5B	CHIP C 1.5PF B	J3	C389			CC73GCH1H050C	CHIP C 5.0PF C	J3

PARTS LIST

TX-RX 3 UNIT (UT-20) (X57-607X-XX)

Ref. No.	Address	New parts	Parts No.	Description	Desti-nation	Ref. No.	Address	New parts	Parts No.	Description	Desti-nation
C389			CC73GCH1H050C	CHIP C 5.0PF C	K3,E5,J2	-			F10-2390-04	SHIELDING CASE	J3
C390-393			CK73GB1H103K	CHIP C 0.010UF K	J3	-			F10-2390-04	SHIELDING CASE	K3,E5,J2
C390-393			CK73GB1H103K	CHIP C 0.010UF K	K3,E5,J2	-			F10-2391-04	SHIELDING CASE	J3
C394			CC73GCH1H010B	CHIP C 1.0PF B	J3	-			F10-2391-04	SHIELDING CASE	K3,E5,J2
C394			CC73GCH1H010B	CHIP C 1.0PF B	K3,E5,J2	-			F10-2394-04	SHIELDING CASE	J3
C395,396			CC73GCH1H180J	CHIP C 18PF J	J3	-			F10-2394-04	SHIELDING CASE	K3,E5,J2
C395,396			CC73GCH1H180J	CHIP C 18PF J	K3,E5,J2	-			F10-2396-03	SHIELDING COVER	J3
C397			CK73GB1H103K	CHIP C 0.010UF K	J3	-			F10-2396-03	SHIELDING COVER	K3,E5,J2
C397			CK73GB1H103K	CHIP C 0.010UF K	K3,E5,J2						
C398			CC73GCH1H330J	CHIP C 33PF J	J3	511	3C		G10-1218-04	FIBROUS SHEET	J3
C398			CC73GCH1H330J	CHIP C 33PF J	K3,E5,J2	511	3C		G10-1218-04	FIBROUS SHEET	K3,E5,J2
C399-401			CK73GB1H103K	CHIP C 0.010UF K	J3	512	3B		J21-8401-04	HARDWARE FIXTURE	J3
C399-401			CK73GB1H103K	CHIP C 0.010UF K	K3,E5,J2	512	3B		J21-8401-04	HARDWARE FIXTURE	K3,E5,J2
C402			CC73GCH1H010B	CHIP C 1.0PF B	J3	-			J61-0307-05	BAND	J3
C402			CC73GCH1H010B	CHIP C 1.0PF B	K3,E5,J2	-			J61-0307-05	BAND	K3,E5,J2
C403			CC73GCH1H030C	CHIP C 3.0PF C	J3	CF1,2		*	L72-1026-05	CERAMIC FILTER (8.4MHz)	J3
C403			CC73GCH1H030C	CHIP C 3.0PF C	K3,E5,J2	CF1,2		*	L72-1026-05	CERAMIC FILTER (8.4MHz)	K3,E5,J2
C404			CK73GB1H102K	CHIP C 1000PF K	J3	L1			L92-0158-05	CHIP FERRITE	J3
C404			CK73GB1H102K	CHIP C 1000PF K	K3,E5,J2	L1			L92-0158-05	CHIP FERRITE	K3,E5,J2
C409			CC73GCH1H010B	CHIP C 1.0PF B	J3	L2		*	L34-4838-05	COIL	J3
C409			CC73GCH1H010B	CHIP C 1.0PF B	K3,E5,J2	L2		*	L34-4838-05	COIL	K3,E5,J2
C500-502			CK73GB1E104K	CHIP C 0.10UF K	J3	L3		*	L34-4845-05	COIL	J3
C500-502			CK73GB1E104K	CHIP C 0.10UF K	K3,E5,J2	L3		*	L34-4845-05	COIL	K3,E5,J2
C503			C90-4116-05	ELECTRO 22UF 16VV	J3	L4			L41-1005-39	SMALL FIXED INDUCTOR (10U)	J3
C503			C90-4116-05	ELECTRO 22UF 16VV	K3,E5,J2	L4			L41-1005-39	SMALL FIXED INDUCTOR (10U)	K3,E5,J2
TC301			C05-0393-05	CERAMIC TRIMMER CAPACITOR (8PF)	J3	L5		*	L34-4845-05	COIL	J3
TC301			C05-0393-05	CERAMIC TRIMMER CAPACITOR (8PF)	K3,E5,J2	L5		*	L34-4845-05	COIL	K3,E5,J2
-			E23-0433-05	EARTH LUG	J3	L7,8		*	L39-1515-05	TOROIDAL COIL	J3
-			E23-0433-05	EARTH LUG	K3,E5,J2	L7,8		*	L39-1515-05	TOROIDAL COIL	K3,E5,J2
501	3B	*	E30-3457-15	ANTENNA CABLE	J3	L9		*	L34-4844-05	COIL	J3
501	3B	*	E30-3457-15	ANTENNA CABLE	K3,E5,J2	L9		*	L34-4844-05	COIL	K3,E5,J2
W2			E37-0894-05	LEAD WIRE WITH TERMINAL	J3	L10		*	L79-1877-05	DIELECTRIC FILTER	J3
W2			E37-0894-05	LEAD WIRE WITH TERMINAL	K3,E5,J2	L10		*	L79-1877-05	DIELECTRIC FILTER	K3,E5,J2
W3			E37-0895-05	LEAD WIRE WITH TERMINAL	J3	L11			L40-1075-92	SMALL FIXED INDUCTOR (10NH)	J3
W3			E37-0895-05	LEAD WIRE WITH TERMINAL	K3,E5,J2	L11			L40-1075-92	SMALL FIXED INDUCTOR (10NH)	K3,E5,J2
504	3C		E37-0943-05	LEAD WIRE WITH MINIPIN PLUG	J3	L12		*	L79-1877-05	DIELECTRIC FILTER	J3
504	3C		E37-0943-05	LEAD WIRE WITH MINIPIN PLUG	K3,E5,J2	L12		*	L79-1877-05	DIELECTRIC FILTER	K3,E5,J2
CN1			E40-6525-05	PIN ASSY	J3	L13			L92-0158-05	CHIP FERRITE	J3
CN1			E40-6525-05	PIN ASSY	K3,E5,J2	L17-19			L92-0158-05	CHIP FERRITE	K3,E5,J2
CN5		*	E40-6527-05	PIN ASSY	J3	L17-19			L92-0158-05	CHIP FERRITE	J3
CN5		*	E40-6527-05	PIN ASSY	K3,E5,J2	L17-19			L92-0158-05	CHIP FERRITE	K3,E5,J2
CN6			E40-5978-05	FLAT CABLE CONNECTOR	J3	L20,21			L92-0403-05	CHIP FERRITE	J3
CN6			E40-5978-05	FLAT CABLE CONNECTOR	K3,E5,J2	L20,21			L92-0403-05	CHIP FERRITE	K3,E5,J2
CN7,8			E04-0428-05	PIN SOCKET	J3	L22		*	L34-4838-05	COIL	J3
CN7,8			E04-0428-05	PIN SOCKET	K3,E5,J2	L22		*	L34-4838-05	COIL	K3,E5,J2
CN9			E04-0190-05	PIN SOCKET	J3	L23			L41-1005-39	SMALL FIXED INDUCTOR (10U)	J3
CN9			E04-0190-05	PIN SOCKET	K3,E5,J2	L23			L41-1005-39	SMALL FIXED INDUCTOR (10U)	K3,E5,J2
CN11-16			E04-0428-05	PIN SOCKET	J3	L24		*	L34-4844-05	COIL	J3
CN11-16			E04-0428-05	PIN SOCKET	K3,E5,J2	L24		*	L34-4844-05	COIL	K3,E5,J2
W51		*	E37-1373-05	LEAD WIRE (BLU)	J3	L25		*	L34-4845-05	COIL	J3
W51		*	E37-1373-05	LEAD WIRE (BLU)	K3,E5,J2	L25		*	L34-4845-05	COIL	K3,E5,J2
W52		*	E37-1375-05	LEAD WIRE (RED)	J3	L26-28		*	L34-4843-05	COIL	J3
W52		*	E37-1375-05	LEAD WIRE (RED)	K3,E5,J2	L26-28		*	L34-4843-05	COIL	K3,E5,J2
W53		*	E37-1374-05	LEAD WIRE (PUR)	J3	L29		*	L34-4844-05	COIL	J3
W53		*	E37-1374-05	LEAD WIRE (PUR)	K3,E5,J2	L29		*	L34-4844-05	COIL	K3,E5,J2
-			F10-2367-04	SHIELDING COVER	J3	L30		*	L79-1874-05	DIELECTRIC FILTER	J3
-			F10-2367-04	SHIELDING COVER	K3,E5,J2	L30		*	L79-1874-05	DIELECTRIC FILTER	K3,E5,J2
506	3C		F10-2368-03	SHIELDING PLATE	J3	L31			L40-8265-92	SMALL FIXED INDUCTOR (8.2NH)	J3
506	3C		F10-2368-03	SHIELDING PLATE	K3,E5,J2	L31			L40-8265-92	SMALL FIXED INDUCTOR (8.2NH)	K3,E5,J2
						L32			L40-8665-92	SMALL FIXED INDUCTOR (6.8NH)	J3

J : TS-2000S J1 : TS-2000V J2 : TS-2000SX J3 : TS-2000VX

K1 : TS-2000 (K) K2 : TS-B2000 (K) K3 : TS-2000X (K)

E1 : TS-2000 (E) E2 : TS-B2000 (E) E3 : TS-2000 (E2) E4 : TS-B2000 (E2) E5 : TS-2000X (E)

PARTS LIST

TX-RX 3 UNIT (UT-20) (X57-607X-XX)

Ref. No.	Address	New parts	Parts No.	Description	Destination	Ref. No.	Address	New parts	Parts No.	Description	Destination
L32			L40-6865-92	SMALL FIXED INDUCTOR (6.8NH)	K3,E5,J2	L336			L40-2285-92	SMALL FIXED INDUCTOR (220NH)	K3,E5,J2
L33		*	L79-1876-05	DIELECTRIC FILTER	J3	L337			L40-5663-92	SMALL FIXED INDUCTOR (5.6NH)	J3
L33		*	L79-1876-05	DIELECTRIC FILTER	K3,E5,J2	L337			L40-5663-92	SMALL FIXED INDUCTOR (5.6NH)	K3,E5,J2
L34			L40-1075-92	SMALL FIXED INDUCTOR (10NH)	J3	L338		*	L34-4817-05	COIL	J3
L34			L40-1075-92	SMALL FIXED INDUCTOR (10NH)	K3,E5,J2	L338		*	L34-4817-05	COIL	K3,E5,J2
L35			L40-5663-92	SMALL FIXED INDUCTOR (5.6NH)	J3	L339		*	L34-4826-05	COIL	J3
L35			L40-5663-92	SMALL FIXED INDUCTOR (5.6NH)	K3,E5,J2	L339		*	L34-4826-05	COIL	K3,E5,J2
L36			L40-2263-92	SMALL FIXED INDUCTOR (2.2NH)	J3	L340-342		*	L34-4846-05	COIL	J3
L36			L40-2263-92	SMALL FIXED INDUCTOR (2.2NH)	K3,E5,J2	L340-342		*	L34-4846-05	COIL	K3,E5,J2
L37			L40-6865-92	SMALL FIXED INDUCTOR (6.8NH)	J3	L343			L41-1005-33	SMALL FIXED INDUCTOR (10UH)	J3
L37			L40-6865-92	SMALL FIXED INDUCTOR (6.8NH)	K3,E5,J2	L343			L41-1005-33	SMALL FIXED INDUCTOR (10UH)	K3,E5,J2
L38			L40-5663-92	SMALL FIXED INDUCTOR (5.6NH)	J3	L344		*	L41-4705-39	SMALL FIXED INDUCTOR (47U)	J3
L38			L40-5663-92	SMALL FIXED INDUCTOR (5.6NH)	K3,E5,J2	L344		*	L41-4705-39	SMALL FIXED INDUCTOR (47U)	K3,E5,J2
L39		*	L41-1085-39	SMALL FIXED INDUCTOR (0.1U)	J3	L345			L41-1005-33	SMALL FIXED INDUCTOR (10UH)	J3
L39		*	L41-1085-39	SMALL FIXED INDUCTOR (0.1U)	K3,E5,J2	L345			L41-1005-33	SMALL FIXED INDUCTOR (10UH)	K3,E5,J2
L40,41			L41-1005-39	SMALL FIXED INDUCTOR (10U)	J3	L346			L40-1085-92	SMALL FIXED INDUCTOR (100NH)	J3
L40,41			L41-1005-39	SMALL FIXED INDUCTOR (10U)	K3,E5,J2	L346			L40-1085-92	SMALL FIXED INDUCTOR (100NH)	K3,E5,J2
L42,43		*	L34-4844-05	COIL	J3	L347			L40-4763-92	SMALL FIXED INDUCTOR (4.7NH)	J3
L42,43		*	L34-4844-05	COIL	K3,E5,J2	L347			L40-4763-92	SMALL FIXED INDUCTOR (4.7NH)	K3,E5,J2
L44			L41-1005-39	SMALL FIXED INDUCTOR (10U)	J3	L348			L40-5663-92	SMALL FIXED INDUCTOR (5.6NH)	J3
L44			L41-1005-39	SMALL FIXED INDUCTOR (10U)	K3,E5,J2	L348			L40-5663-92	SMALL FIXED INDUCTOR (5.6NH)	K3,E5,J2
L45		*	L34-4844-05	COIL	J3	L349			L40-1875-92	SMALL FIXED INDUCTOR (18NH)	J3
L45		*	L34-4844-05	COIL	K3,E5,J2	L349			L40-1875-92	SMALL FIXED INDUCTOR (18NH)	K3,E5,J2
L49-51			L41-1005-39	SMALL FIXED INDUCTOR (10U)	J3	XF1		*	L71-0575-15	MCF	J3
L49-51			L41-1005-39	SMALL FIXED INDUCTOR (10U)	K3,E5,J2	XF1		*	L71-0575-15	MCF	K3,E5,J2
L52		*	L79-1875-05	DIELECTRIC FILTER	J3	XF2			L71-0576-05	MCF	J3
L52		*	L79-1875-05	DIELECTRIC FILTER	K3,E5,J2	XF2			L71-0576-05	MCF	K3,E5,J2
L301			L40-1085-92	SMALL FIXED INDUCTOR (100NH)	J3	P	3C		N30-2606-48	PAN HEAD MACHINE SCREW	J3
L301			L40-1085-92	SMALL FIXED INDUCTOR (100NH)	K3,E5,J2	P	3C		N30-2606-48	PAN HEAD MACHINE SCREW	K3,E5,J2
L302			L40-1278-60	SMALL FIXED INDUCTOR (12NH)	J3	-			N67-2608-48	PAN HEAD SEMS SCREW	J3
L302			L40-1278-60	SMALL FIXED INDUCTOR (12NH)	K3,E5,J2	-			N67-2608-48	PAN HEAD SEMS SCREW	K3,E5,J2
L303,304			L40-1085-92	SMALL FIXED INDUCTOR (100NH)	J3	R	3C		N87-2606-48	BRAZIER HEAD TAPTITE SCREW	J3
L303,304			L40-1085-92	SMALL FIXED INDUCTOR (100NH)	K3,E5,J2	R	3C		N87-2606-48	BRAZIER HEAD TAPTITE SCREW	K3,E5,J2
L305,306			L40-2275-92	SMALL FIXED INDUCTOR (22NH)	J3						
L305,306			L40-2275-92	SMALL FIXED INDUCTOR (22NH)	K3,E5,J2						
L307			L40-1875-92	SMALL FIXED INDUCTOR (18NH)	J3	CP1,2			RK74GB1J101J	CHIP-COM 100 J 1/16W	J3
L307			L40-1875-92	SMALL FIXED INDUCTOR (18NH)	K3,E5,J2	CP1,2			RK74GB1J101J	CHIP-COM 100 J 1/16W	K3,E5,J2
L308			L40-8265-92	SMALL FIXED INDUCTOR (8.2NH)	J3	R2,3			RK73GB2A102J	CHIP R 1.0K J 1/10W	J3
L308			L40-8265-92	SMALL FIXED INDUCTOR (8.2NH)	K3,E5,J2	R2,3			RK73GB2A102J	CHIP R 1.0K J 1/10W	K3,E5,J2
L309			L40-2275-92	SMALL FIXED INDUCTOR (22NH)	J3	R4			RK73GB2A103J	CHIP R 10K J 1/10W	J3
L309			L40-2275-92	SMALL FIXED INDUCTOR (22NH)	K3,E5,J2	R4			RK73GB2A103J	CHIP R 10K J 1/10W	K3,E5,J2
L310			L40-5663-92	SMALL FIXED INDUCTOR (5.6NH)	J3	R5			RK73GB2A273J	CHIP R 27K J 1/10W	J3
L310			L40-5663-92	SMALL FIXED INDUCTOR (5.6NH)	K3,E5,J2	R5			RK73GB2A273J	CHIP R 27K J 1/10W	K3,E5,J2
L312			L40-4763-92	SMALL FIXED INDUCTOR (4.7NH)	J3	R6			RK73GB2A100J	CHIP R 10 J 1/10W	J3
L312			L40-4763-92	SMALL FIXED INDUCTOR (4.7NH)	K3,E5,J2	R6			RK73GB2A100J	CHIP R 10 J 1/10W	K3,E5,J2
L315			L40-4763-92	SMALL FIXED INDUCTOR (4.7NH)	J3	R7			RK73GB2A102J	CHIP R 1.0K J 1/10W	J3
L315			L40-4763-92	SMALL FIXED INDUCTOR (4.7NH)	K3,E5,J2	R7			RK73GB2A102J	CHIP R 1.0K J 1/10W	K3,E5,J2
L318,319			L40-2275-92	SMALL FIXED INDUCTOR (22NH)	J3	R8,9			RK73GB2A680J	CHIP R 68 J 1/10W	J3
L318,319			L40-2275-92	SMALL FIXED INDUCTOR (22NH)	K3,E5,J2	R8,9			RK73GB2A680J	CHIP R 68 J 1/10W	K3,E5,J2
L320,321		*	L34-4843-05	COIL	J3	R10			RK73GB2A103J	CHIP R 10K J 1/10W	J3
L320,321		*	L34-4843-05	COIL	K3,E5,J2	R10			RK73GB2A103J	CHIP R 10K J 1/10W	K3,E5,J2
L322			L40-8265-92	SMALL FIXED INDUCTOR (8.2NH)	J3	R11			RK73GB2A273J	CHIP R 27K J 1/10W	J3
L322			L40-8265-92	SMALL FIXED INDUCTOR (8.2NH)	K3,E5,J2	R11			RK73GB2A273J	CHIP R 27K J 1/10W	K3,E5,J2
L323		*	L41-1595-39	SMALL FIXED INDUCTOR (1.5U)	J3	R12,13			RK73GB2A330J	CHIP R 33 J 1/10W	J3
L323		*	L41-1595-39	SMALL FIXED INDUCTOR (1.5U)	K3,E5,J2	R12,13			RK73GB2A330J	CHIP R 33 J 1/10W	K3,E5,J2
L332			L92-0158-05	CHIP FERRITE	J3	R14,15			RK73GB2A331J	CHIP R 330 J 1/10W	J3
L332			L92-0158-05	CHIP FERRITE	K3,E5,J2	R14,15			RK73GB2A331J	CHIP R 330 J 1/10W	K3,E5,J2
L333			L92-0403-05	CHIP FERRITE	J3	R16			RK73GB2A101J	CHIP R 100 J 1/10W	J3
L333			L92-0403-05	CHIP FERRITE	K3,E5,J2	R16			RK73GB2A101J	CHIP R 100 J 1/10W	K3,E5,J2
L336			L40-2285-92	SMALL FIXED INDUCTOR (220NH)	J3	R17			RK73GB2A271J	CHIP R 270 J 1/10W	J3

PARTS LIST

TX-RX 3 UNIT (UT-20) (X57-607X-XX)

Ref. No.	Address	New parts	Parts No.	Description	Desti-nation	Ref. No.	Address	New parts	Parts No.	Description	Desti-nation
R17			RK73GB2A271J	CHIP R 270 J 1/10W	K3,E5,J2	R51			RK73GB2A101J	CHIP R 100 J 1/10W	K3,E5,J2
R18			RK73GB2A180J	CHIP R 18 J 1/10W	J3	R52			RK73GB2A821J	CHIP R 820 J 1/10W	J3
R18			RK73GB2A180J	CHIP R 18 J 1/10W	K3,E5,J2	R52			RK73GB2A821J	CHIP R 820 J 1/10W	K3,E5,J2
R19			RK73GB2A271J	CHIP R 270 J 1/10W	J3	R53			RK73GB2A332J	CHIP R 3.3K J 1/10W	J3
R19			RK73GB2A271J	CHIP R 270 J 1/10W	K3,E5,J2	R53			RK73GB2A332J	CHIP R 3.3K J 1/10W	K3,E5,J2
R20			RK73GB2A471J	CHIP R 470 J 1/10W	J3	R54			RK73GB2A101J	CHIP R 100 J 1/10W	J3
R20			RK73GB2A471J	CHIP R 470 J 1/10W	K3,E5,J2	R54			RK73GB2A101J	CHIP R 100 J 1/10W	K3,E5,J2
R21			RK73GB2A271J	CHIP R 270 J 1/10W	J3	R55			RK73GB2A682J	CHIP R 6.8K J 1/10W	J3
R21			RK73GB2A271J	CHIP R 270 J 1/10W	K3,E5,J2	R55			RK73GB2A682J	CHIP R 6.8K J 1/10W	K3,E5,J2
R22			RK73GB2A272J	CHIP R 2.7K J 1/10W	J3	R56			RK73GB2A680J	CHIP R 68 J 1/10W	J3
R22			RK73GB2A272J	CHIP R 2.7K J 1/10W	K3,E5,J2	R56			RK73GB2A680J	CHIP R 68 J 1/10W	K3,E5,J2
R23			RK73GB2A180J	CHIP R 18 J 1/10W	J3	R57,58			RK73GB2A222J	CHIP R 2.2K J 1/10W	J3
R23			RK73GB2A180J	CHIP R 18 J 1/10W	K3,E5,J2	R57,58			RK73GB2A222J	CHIP R 2.2K J 1/10W	K3,E5,J2
R24			RK73GB2A472J	CHIP R 4.7K J 1/10W	J3	R59			RK73GB2A000J	CHIP R 0 OHM J 1/10W	J3
R24			RK73GB2A472J	CHIP R 4.7K J 1/10W	K3,E5,J2	R59			RK73GB2A000J	CHIP R 0 OHM J 1/10W	K3,E5,J2
R25			RK73GB2A271J	CHIP R 270 J 1/10W	J3	R60			RK73GB2A332J	CHIP R 3.3K J 1/10W	J3
R25			RK73GB2A271J	CHIP R 270 J 1/10W	K3,E5,J2	R60			RK73GB2A332J	CHIP R 3.3K J 1/10W	K3,E5,J2
R26			RK73GB2A330J	CHIP R 33 J 1/10W	J3	R61			RK73GB2A000J	CHIP R 0 OHM J 1/10W	J3
R26			RK73GB2A330J	CHIP R 33 J 1/10W	K3,E5,J2	R61			RK73GB2A000J	CHIP R 0 OHM J 1/10W	K3,E5,J2
R27			RK73GB2A222J	CHIP R 2.2K J 1/10W	J3	R62,63			RK73GB2A102J	CHIP R 1.0K J 1/10W	J3
R27			RK73GB2A222J	CHIP R 2.2K J 1/10W	K3,E5,J2	R62,63			RK73GB2A102J	CHIP R 1.0K J 1/10W	K3,E5,J2
R28			RK73GB2A101J	CHIP R 100 J 1/10W	J3	R64			RK73GB2A101J	CHIP R 100 J 1/10W	J3
R28			RK73GB2A101J	CHIP R 100 J 1/10W	K3,E5,J2	R64			RK73GB2A101J	CHIP R 100 J 1/10W	K3,E5,J2
R29			RK73GB2A151J	CHIP R 150 J 1/10W	J3	R65			RK73GB2A471J	CHIP R 470 J 1/10W	J3
R29			RK73GB2A151J	CHIP R 150 J 1/10W	K3,E5,J2	R65			RK73GB2A471J	CHIP R 470 J 1/10W	K3,E5,J2
R30			RK73GB2A390J	CHIP R 39 J 1/10W	J3	R66			RK73GB2A474J	CHIP R 470K J 1/10W	J3
R30			RK73GB2A390J	CHIP R 39 J 1/10W	K3,E5,J2	R66			RK73GB2A474J	CHIP R 470K J 1/10W	K3,E5,J2
R31			RK73GB2A151J	CHIP R 150 J 1/10W	J3	R67			RK73GB2A823J	CHIP R 82K J 1/10W	J3
R31			RK73GB2A151J	CHIP R 150 J 1/10W	K3,E5,J2	R67			RK73GB2A823J	CHIP R 82K J 1/10W	K3,E5,J2
R32			RK73GB2A101J	CHIP R 100 J 1/10W	J3	R68			RK73GB2A273J	CHIP R 27K J 1/10W	J3
R32			RK73GB2A101J	CHIP R 100 J 1/10W	K3,E5,J2	R68			RK73GB2A273J	CHIP R 27K J 1/10W	K3,E5,J2
R34			RK73GB2A000J	CHIP R 0 OHM J 1/10W	J3	R70			RK73GB2A470J	CHIP R 47 J 1/10W	J3
R34			RK73GB2A000J	CHIP R 0 OHM J 1/10W	K3,E5,J2	R70			RK73GB2A470J	CHIP R 47 J 1/10W	K3,E5,J2
R35			RK73GB2A680J	CHIP R 68 J 1/10W	J3	R71			RK73GB2A221J	CHIP R 220 J 1/10W	J3
R35			RK73GB2A680J	CHIP R 68 J 1/10W	K3,E5,J2	R71			RK73GB2A221J	CHIP R 220 J 1/10W	K3,E5,J2
R36			RK73GB2A121J	CHIP R 120 J 1/10W	J3	R72			RK73GB2A271J	CHIP R 270 J 1/10W	J3
R36			RK73GB2A121J	CHIP R 120 J 1/10W	K3,E5,J2	R72			RK73GB2A271J	CHIP R 270 J 1/10W	K3,E5,J2
R37			RK73GB2A152J	CHIP R 1.5K J 1/10W	J3	R73			RK73GB2A330J	CHIP R 33 J 1/10W	J3
R37			RK73GB2A152J	CHIP R 1.5K J 1/10W	K3,E5,J2	R73			RK73GB2A330J	CHIP R 33 J 1/10W	K3,E5,J2
R38,39			RK73GB2A470J	CHIP R 47 J 1/10W	J3	R74			RK73GB2A180J	CHIP R 18 J 1/10W	J3
R38,39			RK73GB2A470J	CHIP R 47 J 1/10W	K3,E5,J2	R74			RK73GB2A180J	CHIP R 18 J 1/10W	K3,E5,J2
R40			RK73GB2A101J	CHIP R 100 J 1/10W	J3	R75			RK73GB2A271J	CHIP R 270 J 1/10W	J3
R40			RK73GB2A101J	CHIP R 100 J 1/10W	K3,E5,J2	R75			RK73GB2A271J	CHIP R 270 J 1/10W	K3,E5,J2
R41			RK73GB2A680J	CHIP R 68 J 1/10W	J3	R76,77			RK73GB2A221J	CHIP R 220 J 1/10W	J3
R41			RK73GB2A680J	CHIP R 68 J 1/10W	K3,E5,J2	R76,77			RK73GB2A221J	CHIP R 220 J 1/10W	K3,E5,J2
R42			RK73GB2A101J	CHIP R 100 J 1/10W	J3	R78			RK73GB2A333J	CHIP R 33K J 1/10W	J3
R42			RK73GB2A101J	CHIP R 100 J 1/10W	K3,E5,J2	R78			RK73GB2A333J	CHIP R 33K J 1/10W	K3,E5,J2
R43			RK73RB2H180J	CHIP R 18 J 1/2W	J3	R79,80			RK73GB2A473J	CHIP R 47K J 1/10W	J3
R43			RK73RB2H180J	CHIP R 18 J 1/2W	K3,E5,J2	R79,80			RK73GB2A473J	CHIP R 47K J 1/10W	K3,E5,J2
R45			RK73GB2A182J	CHIP R 1.8K J 1/10W	J3	R81			RK73GB2A101J	CHIP R 100 J 1/10W	J3
R45			RK73GB2A182J	CHIP R 1.8K J 1/10W	K3,E5,J2	R81			RK73GB2A101J	CHIP R 100 J 1/10W	K3,E5,J2
R46			RK73GB2A152J	CHIP R 1.5K J 1/10W	J3	R82			RK73GB2A820J	CHIP R 82 J 1/10W	J3
R46			RK73GB2A152J	CHIP R 1.5K J 1/10W	K3,E5,J2	R82			RK73GB2A820J	CHIP R 82 J 1/10W	K3,E5,J2
R47			RK73GB2A182J	CHIP R 1.8K J 1/10W	J3	R83			RK73GB2A470J	CHIP R 47 J 1/10W	J3
R47			RK73GB2A182J	CHIP R 1.8K J 1/10W	K3,E5,J2	R83			RK73GB2A470J	CHIP R 47 J 1/10W	K3,E5,J2
R48			RK73GB2A103J	CHIP R 10K J 1/10W	J3	R85			RK73GB2A330J	CHIP R 33 J 1/10W	J3
R48			RK73GB2A103J	CHIP R 10K J 1/10W	K3,E5,J2	R85			RK73GB2A330J	CHIP R 33 J 1/10W	K3,E5,J2
R50			RK73RB2H181J	CHIP R 180 J 1/2W	J3	R86			RK73GB2A473J	CHIP R 47K J 1/10W	J3
R50			RK73RB2H181J	CHIP R 180 J 1/2W	K3,E5,J2	R86			RK73GB2A473J	CHIP R 47K J 1/10W	K3,E5,J2
R51			RK73GB2A101J	CHIP R 100 J 1/10W	J3	R87			RK73GB2A102J	CHIP R 1.0K J 1/10W	J3
R51			RK73GB2A101J	CHIP R 100 J 1/10W	K3,E5,J2	R87			RK73GB2A102J	CHIP R 1.0K J 1/10W	K3,E5,J2

J : TS-2000S J1 : TS-2000V J2 : TS-2000SX J3 : TS-2000VX
 K1 : TS-2000 (K) K2 : TS-B2000 (K) K3 : TS-2000X (K)
 E1 : TS-2000 (E) E2 : TS-B2000 (E) E3 : TS-2000 (E2) E4 : TS-B2000 (E2) E5 : TS-2000X (E)

PARTS LIST

TX-RX 3 UNIT (UT-20) (X57-607X-XX)

Ref. No.	Address	New parts	Parts No.	Description	Destination	Ref. No.	Address	New parts	Parts No.	Description	Destination
R87			RK73GB2A102J	CHIP R 1.0K J 1/10W	K3,E5,J2	R126			RK73GB2A101J	CHIP R 100 J 1/10W	K3,E5,J2
R88			RK73GB2A101J	CHIP R 100 J 1/10W	J3	R127			RK73GB2A000J	CHIP R 0 OHM J 1/10W	J3
R88			RK73GB2A101J	CHIP R 100 J 1/10W	K3,E5,J2	R127			RK73GB2A000J	CHIP R 0 OHM J 1/10W	K3,E5,J2
R89			RK73GB2A102J	CHIP R 1.0K J 1/10W	J3	R130			RK73GB2A472J	CHIP R 4.7K J 1/10W	J3
R89			RK73GB2A102J	CHIP R 1.0K J 1/10W	K3,E5,J2	R130			RK73GB2A472J	CHIP R 4.7K J 1/10W	K3,E5,J2
R90			RK73GB2A470J	CHIP R 47 J 1/10W	J3	R131			RK73GB2A182J	CHIP R 1.8K J 1/10W	J3
R90			RK73GB2A470J	CHIP R 47 J 1/10W	K3,E5,J2	R131			RK73GB2A182J	CHIP R 1.8K J 1/10W	K3,E5,J2
R91			RK73GB2A103J	CHIP R 10K J 1/10W	J3	R132			RK73GB2A180J	CHIP R 18 J 1/10W	J3
R91			RK73GB2A103J	CHIP R 10K J 1/10W	K3,E5,J2	R132			RK73GB2A180J	CHIP R 18 J 1/10W	K3,E5,J2
R92			RK73GB2A472J	CHIP R 4.7K J 1/10W	J3	R133			RK73GB2A470J	CHIP R 47 J 1/10W	J3
R92			RK73GB2A472J	CHIP R 4.7K J 1/10W	K3,E5,J2	R133			RK73GB2A470J	CHIP R 47 J 1/10W	K3,E5,J2
R93			RK73GB2A823J	CHIP R 82K J 1/10W	J3	R134			RK73GB2A561J	CHIP R 560 J 1/10W	J3
R93			RK73GB2A823J	CHIP R 82K J 1/10W	K3,E5,J2	R134			RK73GB2A561J	CHIP R 560 J 1/10W	K3,E5,J2
R94			RK73GB2A471J	CHIP R 470 J 1/10W	J3	R135			RK73GB2A560J	CHIP R 56 J 1/10W	J3
R94			RK73GB2A471J	CHIP R 470 J 1/10W	K3,E5,J2	R135			RK73GB2A560J	CHIP R 56 J 1/10W	K3,E5,J2
R95			RK73GB2A561J	CHIP R 560 J 1/10W	J3	R140,141			RK73FB2B820J	CHIP R 82 J 1/8W	J3
R95			RK73GB2A561J	CHIP R 560 J 1/10W	K3,E5,J2	R140,141			RK73FB2B820J	CHIP R 82 J 1/8W	K3,E5,J2
R96			RK73GB2A101J	CHIP R 100 J 1/10W	J3	R301			RK73GB2A471J	CHIP R 470 J 1/10W	J3
R96			RK73GB2A101J	CHIP R 100 J 1/10W	K3,E5,J2	R301			RK73GB2A471J	CHIP R 470 J 1/10W	K3,E5,J2
R97			RK73GB2A270J	CHIP R 27 J 1/10W	J3	R302			RK73GB2A470J	CHIP R 47 J 1/10W	J3
R97			RK73GB2A270J	CHIP R 27 J 1/10W	K3,E5,J2	R302			RK73GB2A470J	CHIP R 47 J 1/10W	K3,E5,J2
R98			RK73GB2A560J	CHIP R 56 J 1/10W	J3	R303			RK73GB2A121J	CHIP R 120 J 1/10W	J3
R98			RK73GB2A560J	CHIP R 56 J 1/10W	K3,E5,J2	R303			RK73GB2A121J	CHIP R 120 J 1/10W	K3,E5,J2
R99			RK73GB2A332J	CHIP R 3.3K J 1/10W	J3	R304			RK73GB2A100J	CHIP R 10 J 1/10W	J3
R99			RK73GB2A332J	CHIP R 3.3K J 1/10W	K3,E5,J2	R304			RK73GB2A100J	CHIP R 10 J 1/10W	K3,E5,J2
R100			RK73GB2A152J	CHIP R 1.5K J 1/10W	J3	R305			RK73GB2A103J	CHIP R 10K J 1/10W	J3
R100			RK73GB2A152J	CHIP R 1.5K J 1/10W	K3,E5,J2	R305			RK73GB2A103J	CHIP R 10K J 1/10W	K3,E5,J2
R101			RK73GB2A822J	CHIP R 8.2K J 1/10W	J3	R306			RK73GB2A332J	CHIP R 3.3K J 1/10W	J3
R101			RK73GB2A822J	CHIP R 8.2K J 1/10W	K3,E5,J2	R306			RK73GB2A332J	CHIP R 3.3K J 1/10W	K3,E5,J2
R102			RK73GB2A153J	CHIP R 15K J 1/10W	J3	R307			RK73GB2A470J	CHIP R 47 J 1/10W	J3
R102			RK73GB2A153J	CHIP R 15K J 1/10W	K3,E5,J2	R307			RK73GB2A470J	CHIP R 47 J 1/10W	K3,E5,J2
R103			RK73GB2A471J	CHIP R 470 J 1/10W	J3	R309,310			RK73GB2A000J	CHIP R 0 OHM J 1/10W	J3
R103			RK73GB2A471J	CHIP R 470 J 1/10W	K3,E5,J2	R309,310			RK73GB2A000J	CHIP R 0 OHM J 1/10W	K3,E5,J2
R104,105			RK73GB2A101J	CHIP R 100 J 1/10W	J3	R311			RK73GB2A331J	CHIP R 330 J 1/10W	J3
R104,105			RK73GB2A101J	CHIP R 100 J 1/10W	K3,E5,J2	R311			RK73GB2A331J	CHIP R 330 J 1/10W	K3,E5,J2
R106			RK73GB2A331J	CHIP R 330 J 1/10W	J3	R312			RK73GB2A823J	CHIP R 82K J 1/10W	J3
R106			RK73GB2A331J	CHIP R 330 J 1/10W	K3,E5,J2	R312			RK73GB2A823J	CHIP R 82K J 1/10W	K3,E5,J2
R108			RK73GB2A102J	CHIP R 1.0K J 1/10W	J3	R314,315			RK73GB2A000J	CHIP R 0.0 J 1/10W	J3
R108			RK73GB2A102J	CHIP R 1.0K J 1/10W	K3,E5,J2	R314,315			RK73GB2A000J	CHIP R 0 OHM J 1/10W	K3,E5,J2
R111			RK73GB2A103J	CHIP R 10K J 1/10W	J3	R318			RK73GB2A102J	CHIP R 1.0K J 1/10W	J3
R111			RK73GB2A103J	CHIP R 10K J 1/10W	K3,E5,J2	R318			RK73GB2A102J	CHIP R 1.0K J 1/10W	K3,E5,J2
R112			RK73GB2A222J	CHIP R 2.2K J 1/10W	J3	R319			RK73GB2A823J	CHIP R 82K J 1/10W	J3
R112			RK73GB2A222J	CHIP R 2.2K J 1/10W	K3,E5,J2	R319			RK73GB2A823J	CHIP R 82K J 1/10W	K3,E5,J2
R117			RK73GB2A271J	CHIP R 270 J 1/10W	J3	R321			RK73GB2A101J	CHIP R 100 J 1/10W	J3
R117			RK73GB2A271J	CHIP R 270 J 1/10W	K3,E5,J2	R321			RK73GB2A101J	CHIP R 100 J 1/10W	K3,E5,J2
R118			RK73GB2A180J	CHIP R 18 J 1/10W	J3	R322			RK73GB2A821J	CHIP R 820 J 1/10W	J3
R118			RK73GB2A180J	CHIP R 18 J 1/10W	K3,E5,J2	R322			RK73GB2A821J	CHIP R 820 J 1/10W	K3,E5,J2
R119,120			RK73GB2A271J	CHIP R 270 J 1/10W	J3	R323			RK73GB2A220J	CHIP R 22 J 1/10W	J3
R119,120			RK73GB2A271J	CHIP R 270 J 1/10W	K3,E5,J2	R323			RK73GB2A220J	CHIP R 22 J 1/10W	K3,E5,J2
R121			RK73GB2A180J	CHIP R 18 J 1/10W	J3	R324			RK73GB2A101J	CHIP R 100 J 1/10W	J3
R121			RK73GB2A180J	CHIP R 18 J 1/10W	K3,E5,J2	R324			RK73GB2A101J	CHIP R 100 J 1/10W	K3,E5,J2
R122			RK73GB2A271J	CHIP R 270 J 1/10W	J3	R325			RK73GB2A182J	CHIP R 1.8K J 1/10W	J3
R122			RK73GB2A271J	CHIP R 270 J 1/10W	K3,E5,J2	R325			RK73GB2A182J	CHIP R 1.8K J 1/10W	K3,E5,J2
R123			RK73GB2A273J	CHIP R 27K J 1/10W	J3	R326			RK73GB2A222J	CHIP R 2.2K J 1/10W	J3
R123			RK73GB2A273J	CHIP R 27K J 1/10W	K3,E5,J2	R326			RK73GB2A222J	CHIP R 2.2K J 1/10W	K3,E5,J2
R124			RK73GB2A103J	CHIP R 10K J 1/10W	J3	R327,328			RK73GB2A000J	CHIP R 0 OHM J 1/10W	J3
R124			RK73GB2A103J	CHIP R 10K J 1/10W	K3,E5,J2	R327,328			RK73GB2A000J	CHIP R 0 OHM J 1/10W	K3,E5,J2
R125			RK73GB2A470J	CHIP R 47 J 1/10W	J3	R329			RK73GB2A474J	CHIP R 470K J 1/10W	J3
R125			RK73GB2A470J	CHIP R 47 J 1/10W	K3,E5,J2	R329			RK73GB2A474J	CHIP R 470K J 1/10W	K3,E5,J2
R126			RK73GB2A101J	CHIP R 100 J 1/10W	J3	R330			RK73GB2A222J	CHIP R 2.2K J 1/10W	J3
R126			RK73GB2A101J	CHIP R 100 J 1/10W	K3,E5,J2	R330			RK73GB2A222J	CHIP R 2.2K J 1/10W	K3,E5,J2

PARTS LIST

TX-RX 3 UNIT (UT-20) (X57-607X-XX)

Ref. No.	Address	New parts	Parts No.	Description	Desti-nation	Ref. No.	Address	New parts	Parts No.	Description	Desti-nation
R330			RK73GB2A222J	CHIP R 2.2K J 1/10W	K3,E5,J2	R384			RK73GB2A470J	CHIP R 47 J 1/10W	K3,E5,J2
R331			RK73GB2A103J	CHIP R 10K J 1/10W	J3	R385,386			RK73GB2A103J	CHIP R 10K J 1/10W	J3
R331			RK73GB2A103J	CHIP R 10K J 1/10W	K3,E5,J2	R385,386			RK73GB2A103J	CHIP R 10K J 1/10W	K3,E5,J2
R332			RK73GB2A000J	CHIP R 0 OHM J 1/10W	J3	R389			RK73GB2A181J	CHIP R 180 J 1/10W	J3
R332			RK73GB2A000J	CHIP R 0 OHM J 1/10W	K3,E5,J2	R389			RK73GB2A181J	CHIP R 180 J 1/10W	K3,E5,J2
R333			RK73GB2A103J	CHIP R 10K J 1/10W	J3	R390			RK73GB2A270J	CHIP R 27 J 1/10W	J3
R333			RK73GB2A103J	CHIP R 10K J 1/10W	K3,E5,J2	R390			RK73GB2A270J	CHIP R 27 J 1/10W	K3,E5,J2
R334			RK73GB2A392J	CHIP R 3.9K J 1/10W	J3	R391			RK73GB2A181J	CHIP R 180 J 1/10W	J3
R334			RK73GB2A392J	CHIP R 3.9K J 1/10W	K3,E5,J2	R391			RK73GB2A181J	CHIP R 180 J 1/10W	K3,E5,J2
R335			RK73GB2A000J	CHIP R 0 OHM J 1/10W	J3	R392			RK73GB2A681J	CHIP R 680 J 1/10W	J3
R335			RK73GB2A000J	CHIP R 0 OHM J 1/10W	K3,E5,J2	R392			RK73GB2A681J	CHIP R 680 J 1/10W	K3,E5,J2
R342			RK73GB2A000J	CHIP R 0 OHM J 1/10W	J3	R500,501			RK73GB2A103J	CHIP R 10K J 1/10W	J3
R342			RK73GB2A000J	CHIP R 0 OHM J 1/10W	K3,E5,J2	R500,501			RK73GB2A103J	CHIP R 10K J 1/10W	K3,E5,J2
R343			RK73GB2A331J	CHIP R 330 J 1/10W	J3	VR1	*		R32-0756-05	TRIMMING POT. (22K/8)	J3
R343			RK73GB2A331J	CHIP R 330 J 1/10W	K3,E5,J2	VR1	*		R32-0756-05	TRIMMING POT. (22K/8)	K3,E5,J2
R351			RK73GB2A000J	CHIP R 0 OHM J 1/10W	J3	VR2			R32-0767-05	TRIMMING POT. (1.0K/8)	J3
R351			RK73GB2A000J	CHIP R 0 OHM J 1/10W	K3,E5,J2	VR2			R32-0767-05	TRIMMING POT. (1.0K/8)	K3,E5,J2
R359			RK73GB2A101J	CHIP R 100 J 1/10W	J3	D1			HSB88WS	DIODE	J3
R359			RK73GB2A101J	CHIP R 100 J 1/10W	K3,E5,J2	D1			HSB88WS	DIODE	K3,E5,J2
R360			RK73GB2A153J	CHIP R 15K J 1/10W	J3	D2			1SS355	DIODE	J3
R360			RK73GB2A153J	CHIP R 15K J 1/10W	K3,E5,J2	D2			1SS355	DIODE	K3,E5,J2
R361			RK73GB2A682J	CHIP R 6.8K J 1/10W	J3	D3,4	*		HSM88ASR-E	DIODE	J3
R361			RK73GB2A682J	CHIP R 6.8K J 1/10W	K3,E5,J2	D3,4	*		HSM88ASR-E	DIODE	K3,E5,J2
R362			RK73GB2A101J	CHIP R 100 J 1/10W	J3	D5-7			L709CER	DIODE	J3
R362			RK73GB2A101J	CHIP R 100 J 1/10W	K3,E5,J2	D5-7			L709CER	DIODE	K3,E5,J2
R363			RK73GB2A151J	CHIP R 150 J 1/10W	J3	D8			DAN235E	DIODE	J3
R363			RK73GB2A151J	CHIP R 150 J 1/10W	K3,E5,J2	D8			DAN235E	DIODE	K3,E5,J2
R364			RK73GB2A101J	CHIP R 100 J 1/10W	J3	D9			1SS355	DIODE	J3
R364			RK73GB2A101J	CHIP R 100 J 1/10W	K3,E5,J2	D9			1SS355	DIODE	K3,E5,J2
R365			RK73GB2A223J	CHIP R 22K J 1/10W	J3	D10,11			RN731V	DIODE	J3
R365			RK73GB2A223J	CHIP R 22K J 1/10W	K3,E5,J2	D10,11			RN731V	DIODE	K3,E5,J2
R366			RK73GB2A822J	CHIP R 8.2K J 1/10W	J3	D12			DAN202K	DIODE	J3
R366			RK73GB2A822J	CHIP R 8.2K J 1/10W	K3,E5,J2	D12			DAN202K	DIODE	K3,E5,J2
R367			RK73GB2A221J	CHIP R 220 J 1/10W	J3	D301			DAN202K	DIODE	K3,E5,J2
R367			RK73GB2A221J	CHIP R 220 J 1/10W	K3,E5,J2	D301			1SV283F	VARIABLE CAPACITANCE DIODE	J3
R368			RK73GB2A000J	CHIP R 0 OHM J 1/10W	J3	D301			1SV283F	VARIABLE CAPACITANCE DIODE	K3,E5,J2
R368			RK73GB2A000J	CHIP R 0 OHM J 1/10W	K3,E5,J2	D302			UDZS4.7B	ZENER DIODE	J3
R369			RK73GB2A330J	CHIP R 33 J 1/10W	J3	D302			UDZS4.7B	ZENER DIODE	K3,E5,J2
R369			RK73GB2A330J	CHIP R 33 J 1/10W	K3,E5,J2	D303			L709CER	DIODE	J3
R370			RK73GB2A183J	CHIP R 18K J 1/10W	J3	D303			L709CER	DIODE	K3,E5,J2
R370			RK73GB2A183J	CHIP R 18K J 1/10W	K3,E5,J2	D304			MA2S111-F	DIODE	J3
R371-373			RK73GB2A330J	CHIP R 33 J 1/10W	J3	D304			MA2S111-F	DIODE	K3,E5,J2
R371-373			RK73GB2A330J	CHIP R 33 J 1/10W	K3,E5,J2	D305			1SV283F	VARIABLE CAPACITANCE DIODE	J3
R374			RK73GB2A222J	CHIP R 2.2K J 1/10W	J3	D305			1SV283F	VARIABLE CAPACITANCE DIODE	K3,E5,J2
R374			RK73GB2A222J	CHIP R 2.2K J 1/10W	K3,E5,J2	D306	*		015AZ3.3(X)F	ZENER DIODE	J3
R375			RK73GB2A101J	CHIP R 100 J 1/10W	J3	IC1	*		015AZ3.3(X)F	ZENER DIODE	K3,E5,J2
R375			RK73GB2A101J	CHIP R 100 J 1/10W	K3,E5,J2	IC1	*		UPC2709TB-A	IC (TX RF AMPLIFIER)	J3
R376			RK73GB2A153J	CHIP R 15K J 1/10W	J3	IC1	*		UPC2709TB-A	IC (TX RF AMPLIFIER)	K3,E5,J2
R376			RK73GB2A153J	CHIP R 15K J 1/10W	K3,E5,J2	IC2			M67715	IC (DRIVE POWER MODULE)	K3,J2,J3
R377			RK73GB2A682J	CHIP R 6.8K J 1/10W	J3	IC2	*		M67715-101	IC (DRIVE POWER MODULE)	E5,
R377			RK73GB2A682J	CHIP R 6.8K J 1/10W	K3,E5,J2	IC3			M57762-02	IC (FINAL POWER MODULE)	K3,J2,J3
R378			RK73GB2A682J	CHIP R 6.8K J 1/10W	K3,E5,J2	IC3	*		M57762-102	IC (FINAL POWER MODULE)	E5,
R378			RK73GB2A151J	CHIP R 150 J 1/10W	J3	IC4	*		AD9851BRSZ	IC (DDS)	J3
R378			RK73GB2A151J	CHIP R 150 J 1/10W	K3,E5,J2	IC4	*		AD9851BRSZ	IC (DDS)	K3,E5,J2
R379			RK73GB2A101J	CHIP R 100 J 1/10W	J3	IC5			LMX2316TMX	IC (PLL)	J3
R379			RK73GB2A101J	CHIP R 100 J 1/10W	K3,E5,J2	IC5			LMX2316TMX	IC (PLL)	K3,E5,J2
R381			RK73GB2A000J	CHIP R 0 OHM J 1/10W	J3	IC500	*		BA90DDOWHFP	IC (AVR 9V)	J3
R381			RK73GB2A000J	CHIP R 0 OHM J 1/10W	K3,E5,J2	IC500	*		BA90DDOWHFP	IC (AVR 9V)	K3,E5,J2
R383			RK73GB2A102J	CHIP R 1.0K J 1/10W	J3	Q1,2	*		3SK131-A(M)	FET	J3
R383			RK73GB2A102J	CHIP R 1.0K J 1/10W	K3,E5,J2	Q1,2	*		3SK131-A(M)	FET	K3,E5,J2
R384			RK73GB2A470J	CHIP R 47 J 1/10W	J3						

J : TS-2000S J1 : TS-2000V J2 : TS-2000SX J3 : TS-2000VX

K1 : TS-2000 (K) K2 : TS-B2000 (K) K3 : TS-2000X (K)

E1 : TS-2000 (E) E2 : TS-B2000 (E) E3 : TS-2000 (E2) E4 : TS-B2000 (E2) E5 : TS-2000X (E)

PARTS LIST

TX-RX 3 UNIT (UT-20) (X57-607X-XX)

Ref. No.	Address	New parts	Parts No.	Description	Destination	Ref. No.	Address	New parts	Parts No.	Description	Destination
Q3		*	2SC3356-A	TRANSISTOR	J3						
Q3		*	2SC3356-A	TRANSISTOR	K3,E5,J2						
Q4			UMC4N	TRANSISTOR	J3						
Q4			UMC4N	TRANSISTOR	K3,E5,J2						
Q5		*	2SC4093-A	TRANSISTOR	J3						
Q5		*	2SC4093-A	TRANSISTOR	K3,E5,J2						
Q7,8			2SK520(K43)	FET	K3,J2,J3						
Q7,8		*	2SK520-A(K43)	FET	E5						
Q9		*	3SK131-A(M)	FET	J3						
Q9		*	3SK131-A(M)	FET	K3,E5,J2						
Q10		*	3SK320-F	FET	J3						
Q10		*	3SK320-F	FET	K3,E5,J2						
Q11		*	2SC5008-T1-A	TRANSISTOR	J3						
Q11		*	2SC5008-T1-A	TRANSISTOR	K3,E5,J2						
Q12		*	NE34018	FET	J3						
Q12		*	NE34018	FET	K3,E5,J2						
Q13			2SC4617(R)	TRANSISTOR	J3						
Q13			2SC4617(R)	TRANSISTOR	K3,E5,J2						
Q14,15			2SC5108(YF)	TRANSISTOR	J3						
Q14,15			2SC5108(YF)	TRANSISTOR	K3,E5,J2						
Q16,17			2SC4617(R)	TRANSISTOR	J3						
Q16,17			2SC4617(R)	TRANSISTOR	K3,E5,J2						
Q19		*	2SC3356-A	TRANSISTOR	J3						
Q19		*	2SC3356-A	TRANSISTOR	K3,E5,J2						
Q20			2SC3357-A	TRANSISTOR	J3						
Q20			2SC3357-A	TRANSISTOR	K3,E5,J2						
Q301			2SK508NV(K52)	FET	J3						
Q301			2SK508NV(K52)	FET	K3,E5,J2						
Q302			2SC5066-F(O)	TRANSISTOR	J3						
Q302			2SC5066-F(O)	TRANSISTOR	K3,E5,J2						
Q303,304			2SC4617(R)	TRANSISTOR	J3						
Q303,304			2SC4617(R)	TRANSISTOR	K3,E5,J2						
Q305-307			2SC3722K(R)	TRANSISTOR	J3						
Q305-307			2SC3722K(R)	TRANSISTOR	K3,E5,J2						
Q310-312			2SC4617(R)	TRANSISTOR	J3						
Q310-312			2SC4617(R)	TRANSISTOR	K3,E5,J2						
Q313,314		*	3SK131-A(M)	FET	J3						
Q313,314		*	3SK131-A(M)	FET	K3,E5,J2						
Q315			2SC4617(R)	TRANSISTOR	J3						
Q315			2SC4617(R)	TRANSISTOR	K3,E5,J2						
TH1			157-102-65001	THERMISTOR	J3						
TH1			157-102-65001	THERMISTOR	K3,E5,J2						
TH2			157-502-65001	THERMISTOR	J3						
TH2			157-502-65001	THERMISTOR	K3,E5,J2						

FINAL UNIT (X45-360X-XX) (A/2) Component side view (J79-0110-09 A/2)
0-00 : J,J2 0-01 : J1,J3 0-11 : K1,K2,K3 2-71 : E1,E2,E3,E4,E5

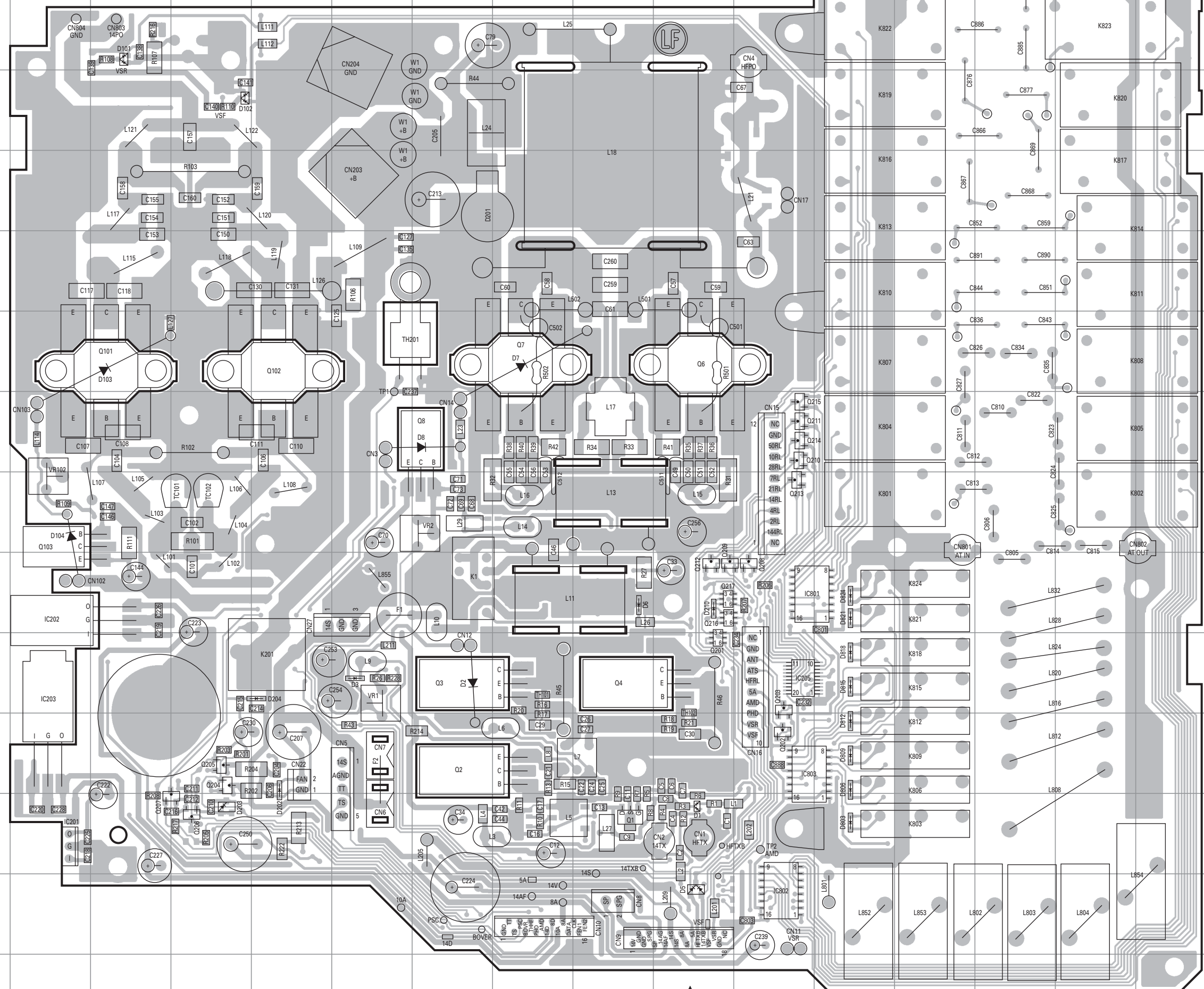

Ref. No.	Address	Ref. No.	Address
IC201	12B	Q213	8K
IC202	9B	Q214	7K
IC203	10B	Q215	7K
IC205	10K	Q216	9J
IC801	9K	Q217	9J
IC802	13K	D1	12J
IC803	11K	D2	10G
Q1	12I	D3	10F
Q2	11G	D5	13J
Q3	10G	D6	9I
Q4	10I	D7	6H
Q6	6J	D8	7G
Q7	6H	D101	2C
Q8	7G	D102	3D
Q101	6C	D103	6C
Q102	6E	D104	8B
Q103	8B	D201	4G
Q201	10J	D202	12E
Q202	11K	D203	12D
Q203	10K	D204	10E
Q204	11D	D210	9J
Q205	11D	D803	12L
Q206	12D	D806	11L
Q207	12C	D809	11L
Q208	9K	D812	11L
Q209	9J	D815	10L
Q210	7K	D818	10L
Q211	7K	D821	9L
Q212	9J	D824	9L

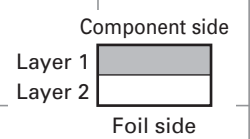

TS-2000/B2000/2000X
 TS-2000S/2000V/2000SX/2000VX **PC BOARD**

J79-0110-09 A/2

FINAL UNIT (X45-360X-XX) (A/2) Foil side view (J79-0110-09 A/2)
 0-00 : J,J2 0-01 : J1,J3 0-11 : K1,K2,K3 2-71 : E1,E2,E3,E4,E5

Ref. No.	Address
IC204	11Q
Q218	10O
D206	9I
D207	9I
D208	9I
D209	9I
D211	10O
D801	8H
D802	8D
D804	7H
D805	7D
D807	6H
D808	6D
D810	5H
D811	5D
D813	4H
D814	4D
D816	4H
D817	3D
D819	3H
D820	3D
D822	2H
D823	2D

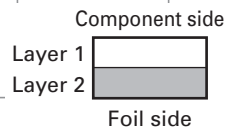
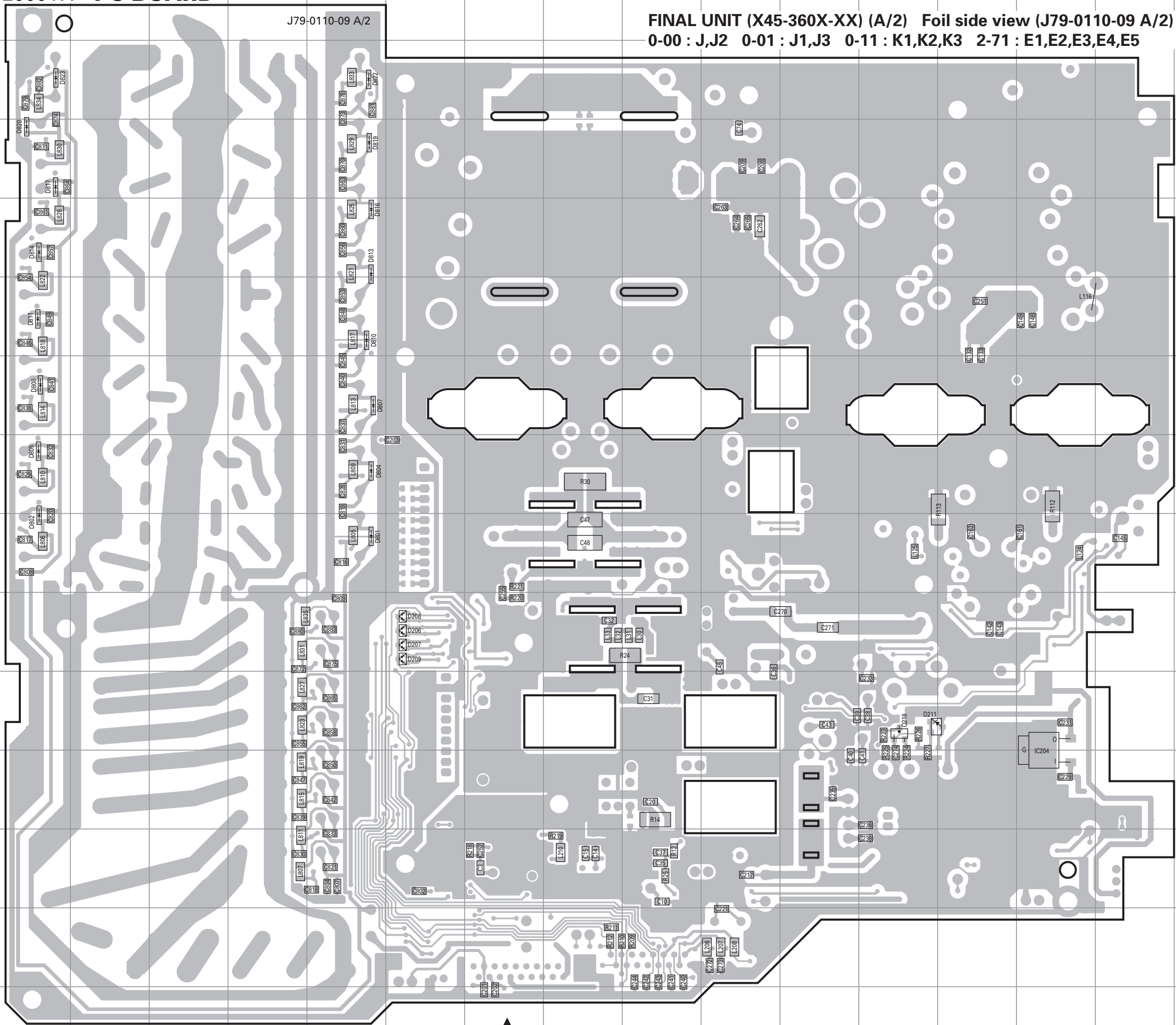

FINAL UNIT (X45-360X-XX) (B/2) Component side view (J79-0110-09 B/2)
0-00 : J,J2 0-01 : J1,J3 0-11 : K1,K2,K3 2-71 : E1,E2,E3,E4,E5

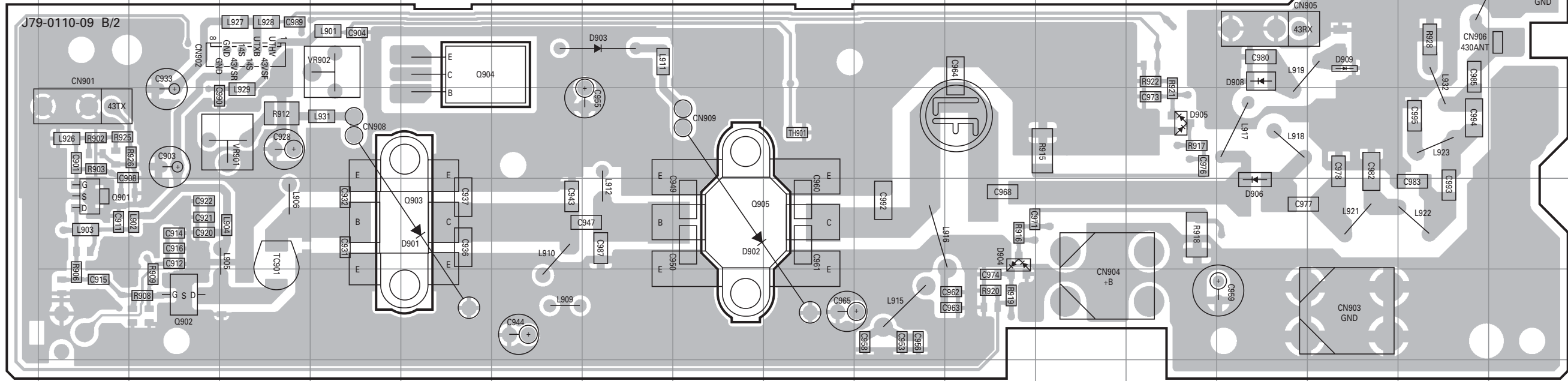

Ref. No.	Address
Q901	5A
Q902	6B
Q903	5E
Q904	3E
Q905	5H
D901	5E
D902	5H
D903	3G
D904	5K
D905	4M
D906	5N
D908	3N
D909	3O

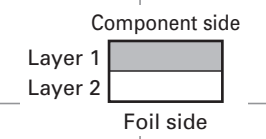

FINAL UNIT (X45-360X-XX) (B/2) Foil side view (J79-0110-09 B/2)
0-00 : J,J2 0-01 : J1,J3 0-11 : K1,K2,K3 2-71 : E1,E2,E3,E4,E5

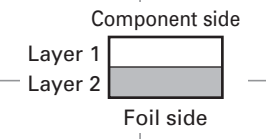
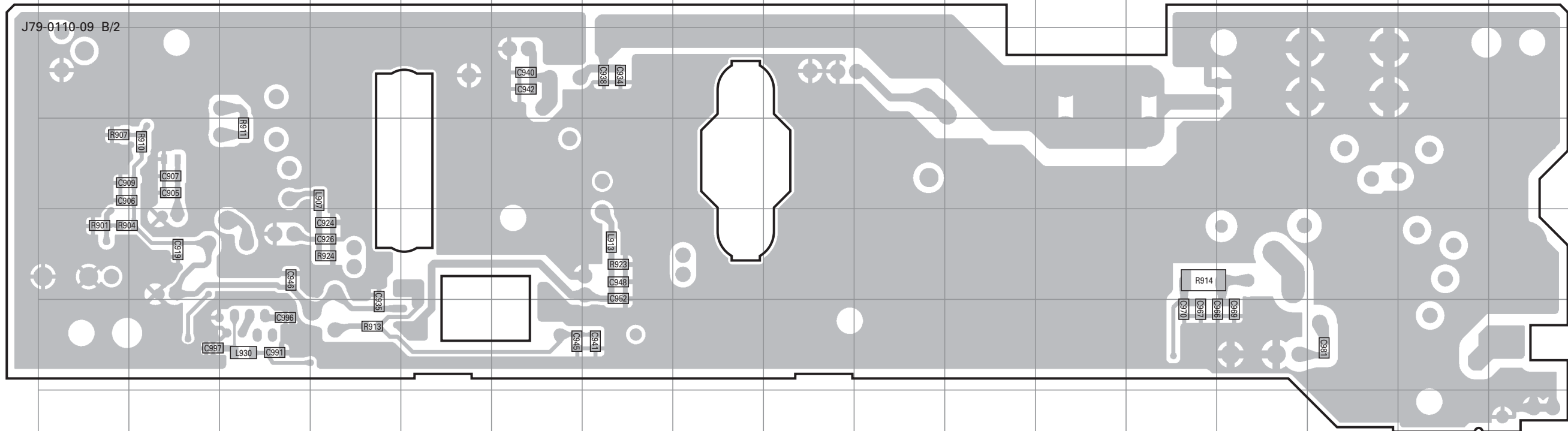

TS-2000/B2000/2000X
 TS-2000S/2000V/2000SX/2000VX **PC BOARD**

FILTER UNIT (X51-315X-XX) 0-00 : J,J2 0-01 : J1,J3 0-11 : K1,K2,K3 2-71 : E1,E2,E3,E4,E5 Component side view (J79-0111-09)

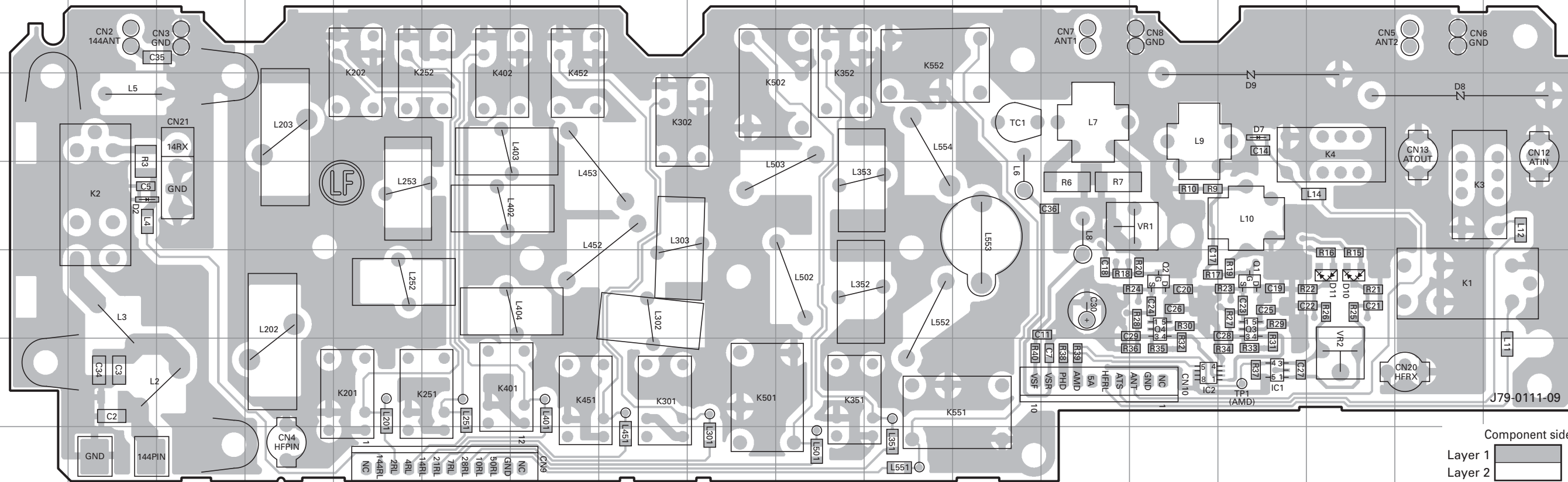

Ref. No.	Address
IC1	6O
IC2	6N
Q1	5O
Q2	5N
Q3	5O
Q4	5N
D2	4B
D7	3O
D8	3Q
D9	3O
D10	5P
D11	5P

Component side
 Layer 1
 Layer 2
 Foil side

FILTER UNIT (X51-315X-XX) 0-00 : J,J2 0-01 : J1,J3 0-11 : K1,K2,K3 2-71 : E1,E2,E3,E4,E5 Foil side view (J79-0111-09)

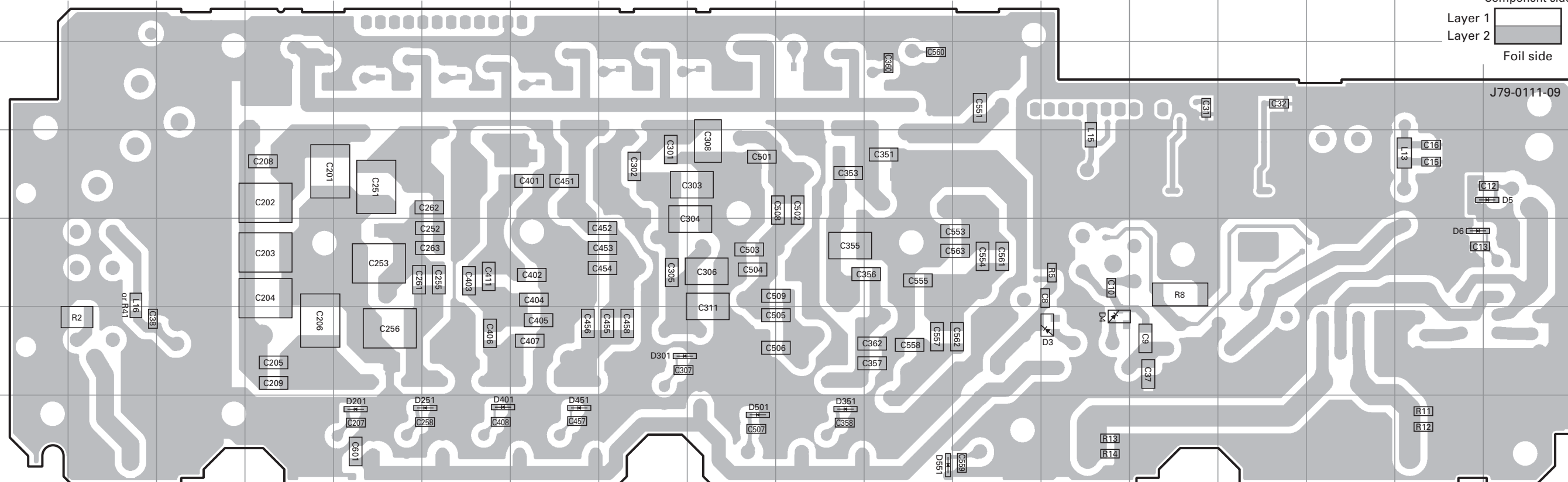

Ref. No.	Address
D3	12M
D4	12M
D5	10R
D6	11Q
D201	13E
D251	13F
D301	12H
D351	13J
D401	13F
D451	13G
D501	13I
D551	13K

Component side
 Layer 1
 Layer 2
 Foil side

DISPLAY UNIT (X54-3320-00) Component side view (J79-0113-09) : J,J1,J2,J3,K1,K3,E1,E3,E5

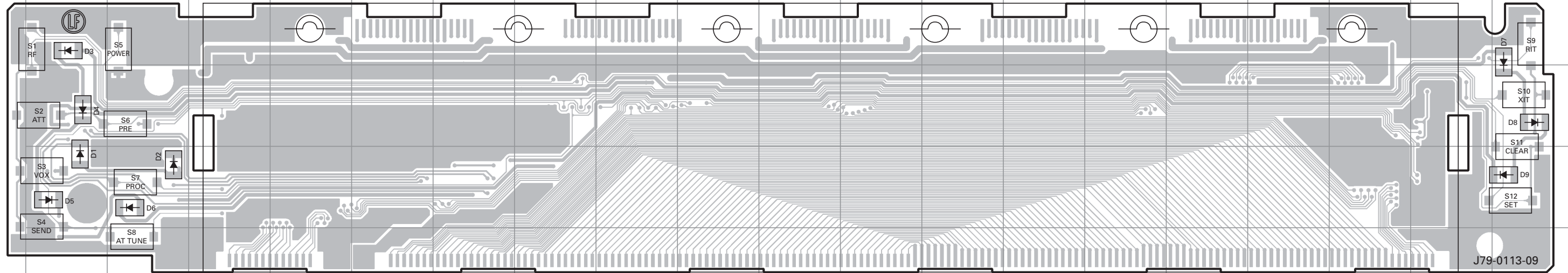

Ref. No.	Address	Ref. No.	Address
D1	4A	D6	4B
D2	4B	D7	2S
D3	2A	D8	3S
D4	3A	D9	4S
D5	4A		

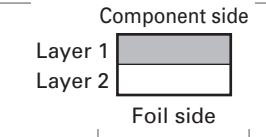

DISPLAY UNIT (X54-3320-00) Foil side view (J79-0113-09) : J,J1,J2,J3,K1,K3,E1,E3,E5

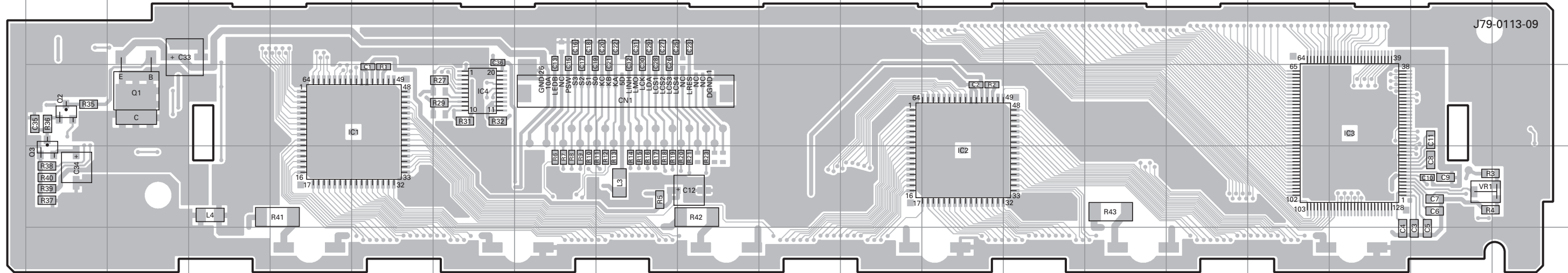

Ref. No.	Address	Ref. No.	Address
IC1	9E	Q1	9B
IC2	10L	Q2	9A
IC3	9Q	Q3	10A
IC4	9F		

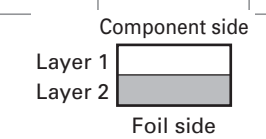

TS-2000/B2000/2000X
 TS-2000S/2000V/2000SX/2000VX **PC BOARD**

CONTROL UNIT (X53-391X-XX) 0-00 : J,J2 0-01 : J1,J3 0-11 : K1,K2,K3 2-71 : E1,E2,E5 2-72 : E3,E4 Component side view (J79-0112-09)

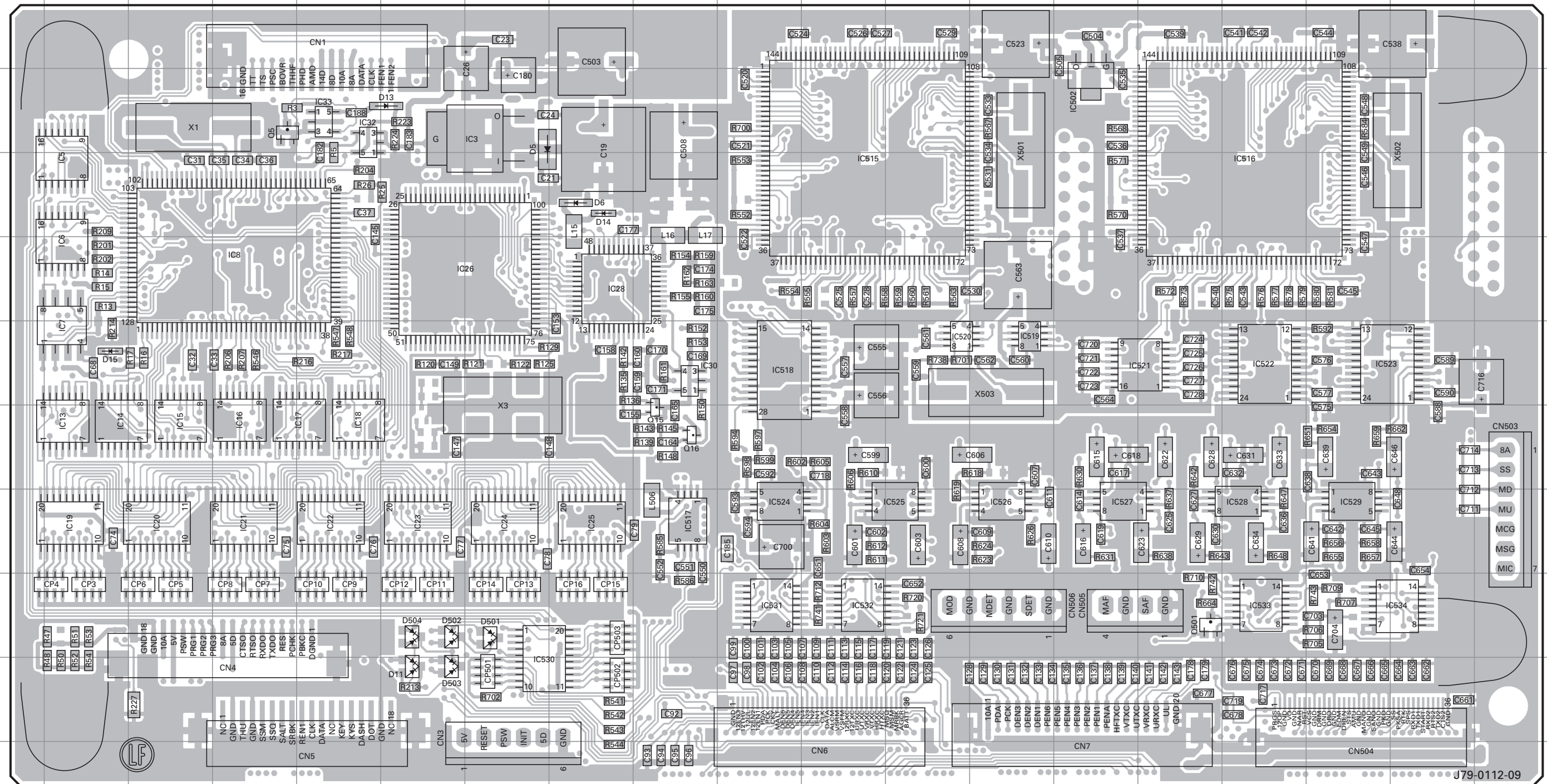

J79-0112-09

Ref No.	Address	Ref No.	Address	Ref No.	Address	Ref No.	Address	Ref No.	Address	Ref No.	Address	Ref No.	Address
IC3	3G	IC17	7E	IC26	5G	IC518	6J	IC527	8N	Q15	7I	D501	9G
IC5	4B	IC18	7E	IC28	5H	IC519	6M	IC528	8P	Q16	7I	D502	9F
IC6	5B	IC19	8B	IC30	6I	IC520	6L	IC529	8Q	Q501	9O	D503	10F
IC7	6B	IC20	8C	IC32	3E	IC521	6O	IC530	10G	D5	3G	D504	9F
IC8	5D	IC21	8D	IC33	3E	IC522	6P	IC531	9J	D6	4H		
IC13	7B	IC22	8E	IC502	3N	IC523	6Q	IC532	9K	D11	10F		
IC14	7B	IC23	8F	IC515	4K	IC524	8J	IC533	9P	D13	3F		
IC15	7C	IC24	8G	IC516	4P	IC525	8L	IC534	9R	D14	4H		
IC16	7D	IC25	8H	IC517	8I	IC526	8M	Q5	3D	D15	6B		

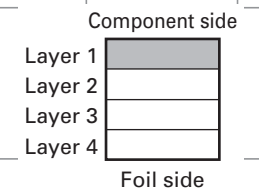

CONTROL UNIT (X53-391X-XX) 0-00 : J,J2 0-01 : J1,J3 0-11 : K1,K2,K3 2-71 : E1,E2,E5 2-72 : E3,E4 Foil side view (J79-0112-09)

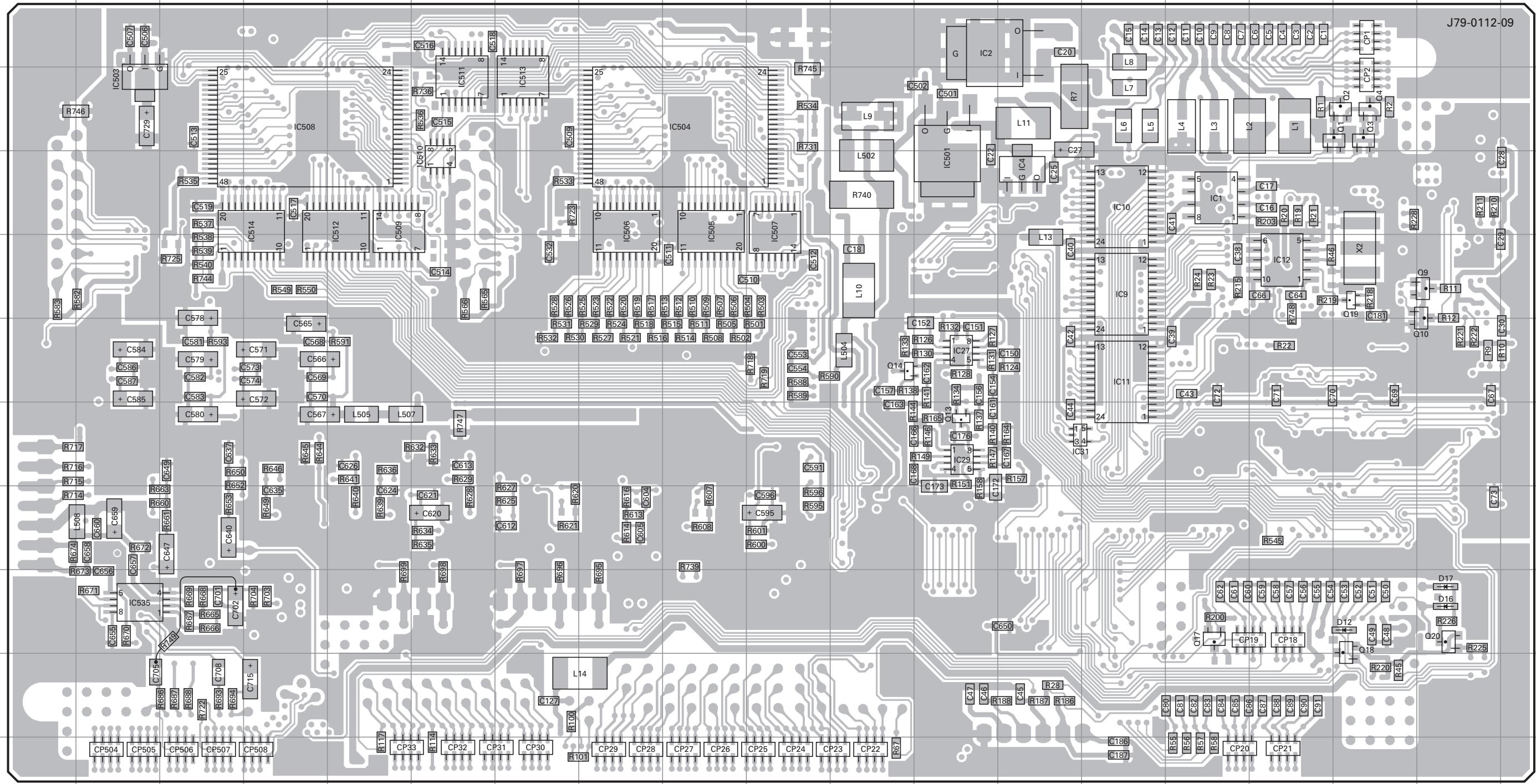

Ref No.	Address	Ref No.	Address	Ref No.	Address	Ref No.	Address	Ref No.	Address
IC1	4O	IC31	7M	IC510	4F	Q4	3Q	D12	9Q
IC2	2L	IC501	4L	IC511	3F	Q9	5R	D16	9R
IC4	4M	IC503	3B	IC512	4E	Q10	6R	D17	9R
IC9	5N	IC504	3I	IC513	3G	Q13	7L		
IC10	4N	IC505	4I	IC514	4D	Q14	6K		
IC11	6N	IC506	4H	IC535	9B	Q17	9O		
IC12	5P	IC507	4J	Q1	3Q	Q18	9Q		
IC27	6L	IC508	3D	Q2	3Q	Q19	5Q		
IC29	7L	IC509	4E	Q3	3Q	Q20	9R		

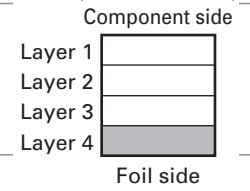

TS-2000/B2000/2000X
 TS-2000S/2000V/2000SX/2000VX **PC BOARD**

TX-RX 1 UNIT (X57-605X-XX) (A/9) Component side view (J79-0107-09 A/9)
 0-00 : J,J2 0-01 : J1,J3 0-11 : K1,K3 0-12 : K2 2-71 : E1,E3,E5 2-72 : E2,E4

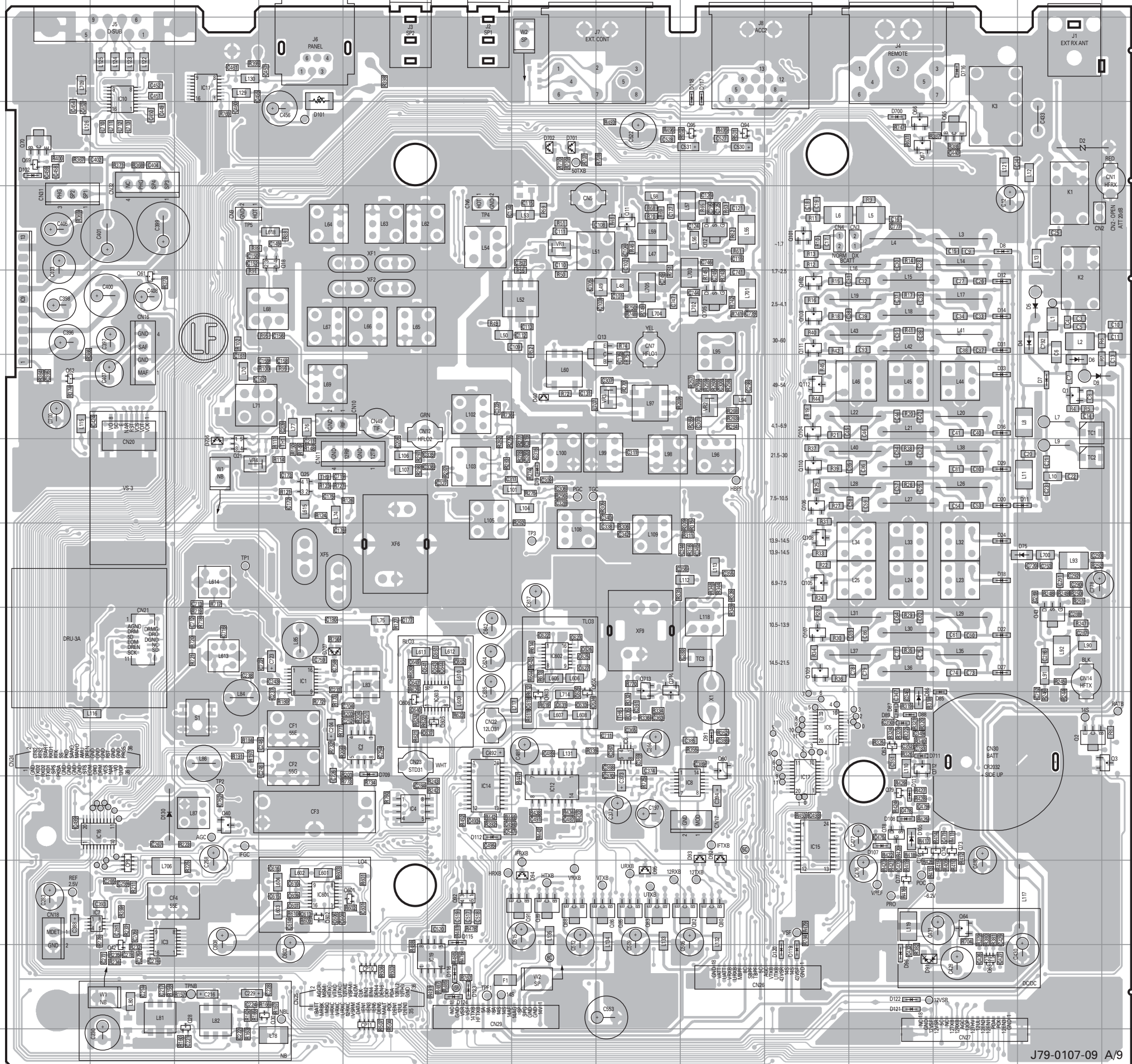

Ref. No.	Address	Ref. No.	Address	Ref. No.	Address
IC1	9E	Q77	12L	D20	7M
IC2	10F	Q78	11L	D22	9M
IC3	12C	Q79	11L	D24	8M
IC4	11F	Q80	12J	D27	9M
IC5	10K	Q82	12J	D29	7M
IC6	10I	Q83	12I	D31	5M
IC7	12C	Q85	12I	D33	6M
IC8	11J	Q86	12I	D40	6H
IC9	5B	Q88	12H	D75	8N
IC10	2C	Q89	12H	D79	7H
IC11	2D	Q91	12H	D85	10M
IC12	11H	Q92	12G	D86	10L
IC14	11G	Q94	3J	D87	10L
IC15	11K	Q95	3J	D88	10L
IC16	11C	Q101	4K	D89	10L
IC17	11K	Q102	5K	D91	10J
IC19	13G	Q103	5K	D91	13L
IC601	12E	Q104	6K	D92	11J
IC602	9H	Q105	8K	D93	11J
IC603	10G	Q106	7K	D94	12H
Q1	6N	Q107	9K	D95	12I
Q2	10N	Q108	8K	D96	13L
Q3	10O	Q109	9K	D101	3E
Q11	4I	Q110	7K	D102	3B
Q12	4J	Q111	5K	D105	11L
Q13	5I	Q112	6K	D107	11L
Q18	4E	Q601	12F	D108	11L
Q21	7D	Q602	12E	D111	11L
Q25	7E	Q603	10H	D112	11G
Q28	13D	Q604	9H	D115	12G
Q30	13E	Q605	10G	D116	13G
Q40	11D	Q606	10F	D117	2J
Q42	13C	Q705	5J	D118	2J
Q43	9N	Q712	10L	D119	13K
Q52	10L	Q713	9I	D120	13K
Q60	10J	Q714	9I	D121	13L
Q61	5C	D2	3N	D122	13L
Q62	6B	D4	5N	D123	13G
Q63	13M	D5	5N	D124	13G
Q64	12M	D6	6N	D130	11C
Q65	3M	D7	6N	D700	3L
Q66	3L	D8	4M	D701	3H
Q67	3L	D9	6N	D702	3H
Q69	3B	D11	7N	D706	7D
Q70	3B	D12	5M	D707	9E
Q73	11M	D14	5M	D709	11F
Q74	11M	D16	6M	D711	10L
Q76	11L	D18	8M	D716	2M

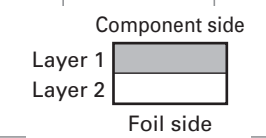

TX-RX 1 UNIT (X57-605X-XX) (A/9) Foil side view (J79-0107-09 A/9)

0-00 : J,J2 0-01 : J1,J3 0-11 : K1,K3 0-12 : K2 2-71 : E1,E3,E5 2-72 : E2,E4

PC BOARD

TS-2000/B2000/2000X
TS-2000S/2000V/2000SX/2000VX

Ref. No.	Address	Ref. No.	Address	Ref. No.	Address
IC13	11M	Q93	2I	D55	8N
IC18	12Q	Q96	3J	D56	8O
IC604	2P	Q97	13L	D57	8O
IC605	10K	Q607	4L	D58	8N
Q4	3F	Q608	5M	D60	8O
Q5	4F	Q609	10P	D61	9O
Q6	6I	Q700	9P	D62	9N
Q7	5L	Q701	9P	D64	8O
Q8	5L	Q702	7O	D65	11L
Q9	4L	Q703	6O	D66	14P
Q10	4L	Q704	10K	D67	10O
Q14	4K	Q706	5J	D68	9P
Q15	4K	Q707	4K	D69	10O
Q16	4O	Q708	4K	D70	10O
Q17	4O	Q709	12Q	D71	10O
Q19	6O	Q710	9O	D73	10P
Q20	6P	Q711	8J	D76	6J
Q22	7P	Q715	8Q	D77	7K
Q26	13Q	D1	4F	D78	7K
Q27	13P	D3	5F	D80	7M
Q29	13P	D10	4I	D81	7N
Q31	13O	D13	5I	D82	7M
Q32	9N	D15	5I	D83	10K
Q33	5P	D17	6I	D84	8K
Q34	10N	D19	8I	D90	8J
Q37	10P	D21	7I	D98	2G
Q38	11P	D23	9I	D99	2Q
Q41	13Q	D25	8I	D100	2Q
Q44	6J	D26	6I	D103	2K
Q45	6J	D28	9I	D104	2L
Q46	6L	D30	7I	D106	3I
Q47	7L	D32	5I	D109	3L
Q48	7M	D34	6I	D110	3K
Q49	7L	D35	4I	D113	11L
Q51	10H	D36	4K	D114	11L
Q53	9K	D38	4I	D703	6M
Q54	10K	D39	4K	D704	5I
Q57	9K	D41	4M	D705	5K
Q58	8J	D42	4O	D708	2P
Q59	9J	D45	6N	D712	2J
Q71	3L	D46	6O	D713	2I
Q72	3L	D47	6O	D714	9K
Q75	11H	D48	13O	D715	6M
Q81	12J	D49	7N	D717	2J
Q84	12K	D50	7N	D719	2P
Q87	12K	D52	8O	D720	2P
Q90	12L	D53	7N	D721	3P

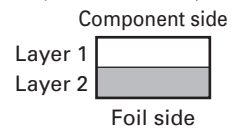
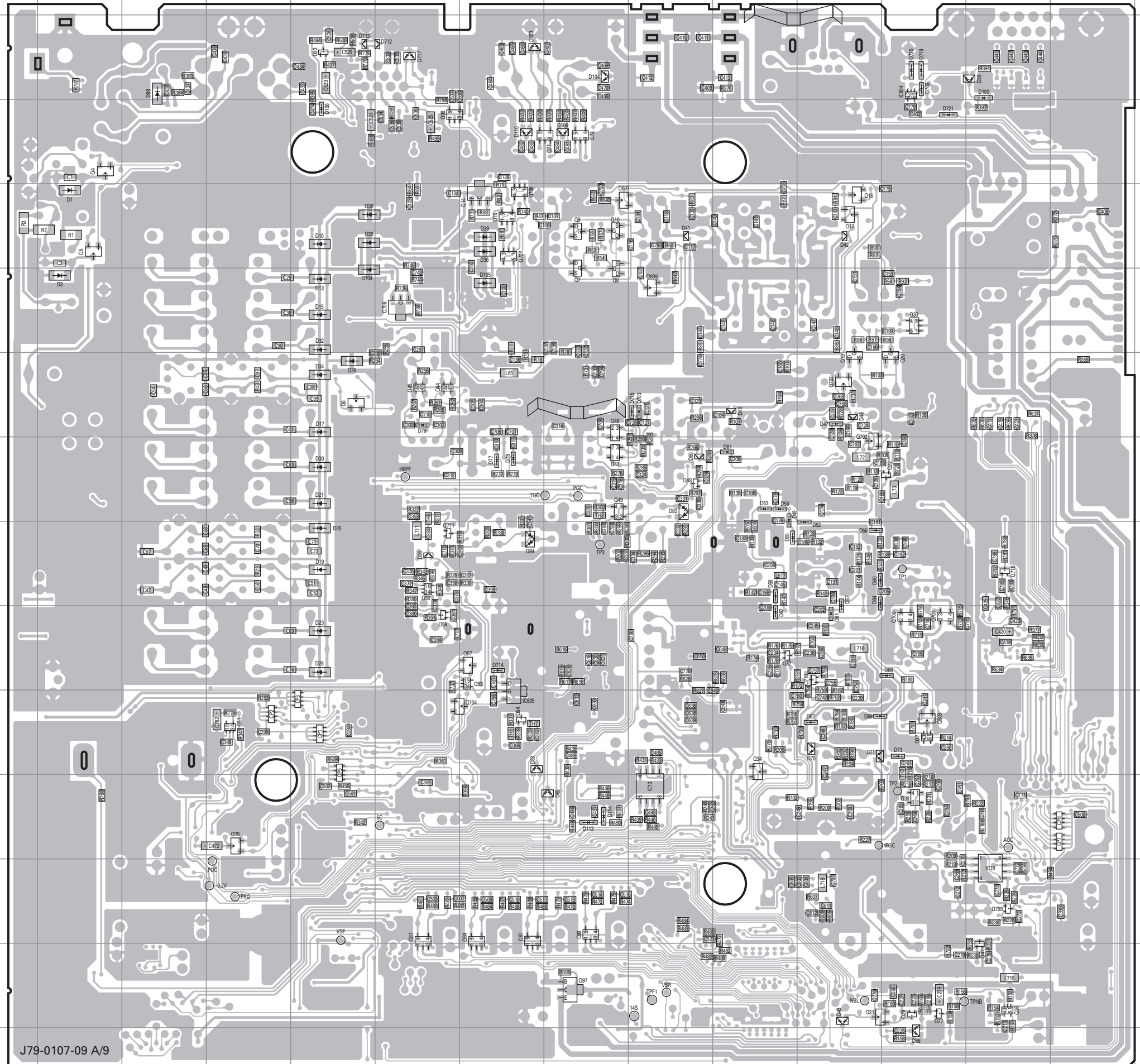

J79-0107-09 A/9

TS-2000/B2000/2000X
 TS-2000S/2000V/2000SX/2000VX **PC BOARD**

TX-RX 1 UNIT (X57-605X-XX) (B/9) 0-00 : J,J2 0-01 : J1,J3 0-11 : K1,K3 0-12 : K2 2-71 : E1,E3,E5 2-72 : E2,E4 Component side view (J79-0107-09 B/9)

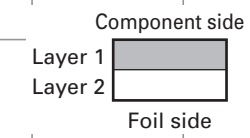
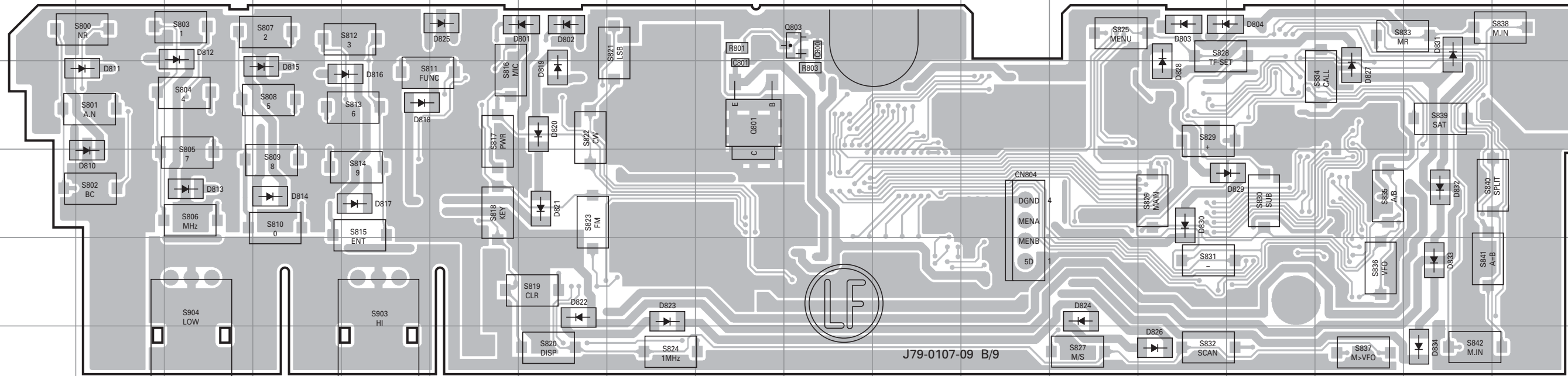

Ref. No.	Address
Q801	3I
Q803	2J
D801	2G
D802	2G
D803	2N
D804	2O
D810	4B
D811	3B
D812	2C
D813	4C
D814	4D
D815	3D
D816	3E
D817	4E
D818	3E
D819	3G
D820	3G
D821	4G
D822	5G
D823	5H
D824	5M
D825	2F
D826	6N
D827	3P
D828	3N
D829	4O
D830	4N
D831	2Q
D832	4Q
D833	5Q
D834	6Q

TX-RX 1 UNIT (X57-605X-XX) (B/9) 0-00 : J,J2 0-01 : J1,J3 0-11 : K1,K3 0-12 : K2 2-71 : E1,E3,E5 2-72 : E2,E4 Foil side view (J79-0107-09 B/9)

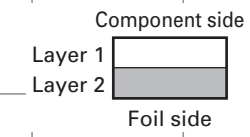
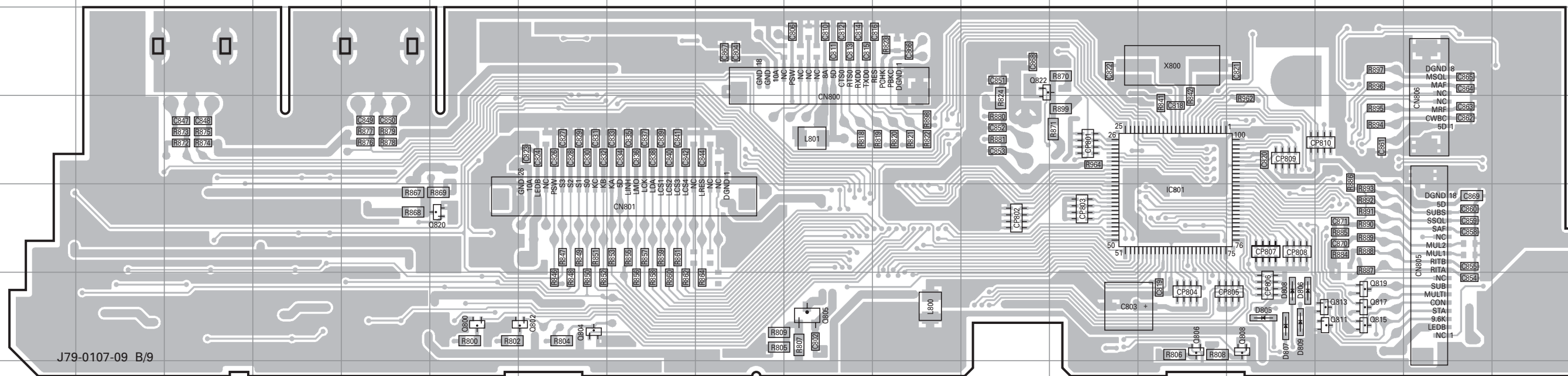

Ref. No.	Address
IC801	11N
Q800	12F
Q802	12G
Q804	12G
Q805	12J
Q806	12N
Q808	12O
Q811	12P
Q813	12P
Q815	12P
Q817	12P
Q819	12P
Q820	11F
Q822	9L
D805	12O
D806	12O
D807	12O
D808	12O
D809	12O

TX-RX 1 UNIT (X57-605X-XX) (C,D,E,F,G/9) 0-00 : J,J2 0-01 : J1,J3 0-11 : K1,K3 2-71 : E1,E3,E5 Component side view (J79-0107-09 C,D,E,F,G/9)
TX-RX 1 UNIT (X57-605X-XX) (F,H,I/9) 0-12 : K2 2-72 : E2,E4 Component side view (J79-0107-09 F,H,I/9)

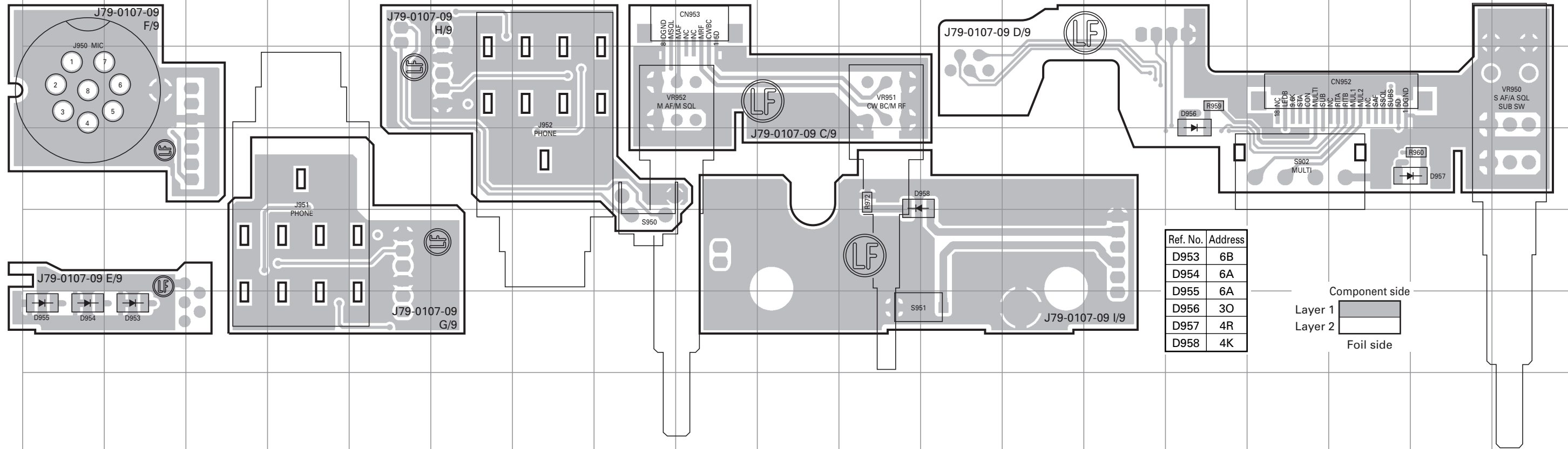

Ref. No.	Address
D953	6B
D954	6A
D955	6A
D956	3O
D957	4R
D958	4K

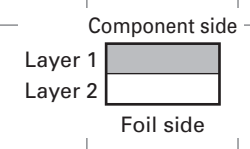

TX-RX 1 UNIT (X57-605X-XX) (C,D,E,F,G/9) 0-00 : J,J2 0-01 : J1,J3 0-11 : K1,K3 2-71 : E1,E3,E5 Foil side view (J79-0107-09 C,D,E,F,G/9)
TX-RX 1 UNIT (X57-605X-XX) (F,H,I/9) 0-12 : K2 2-72 : E2,E4 Foil side view (J79-0107-09 F,H,I/9)

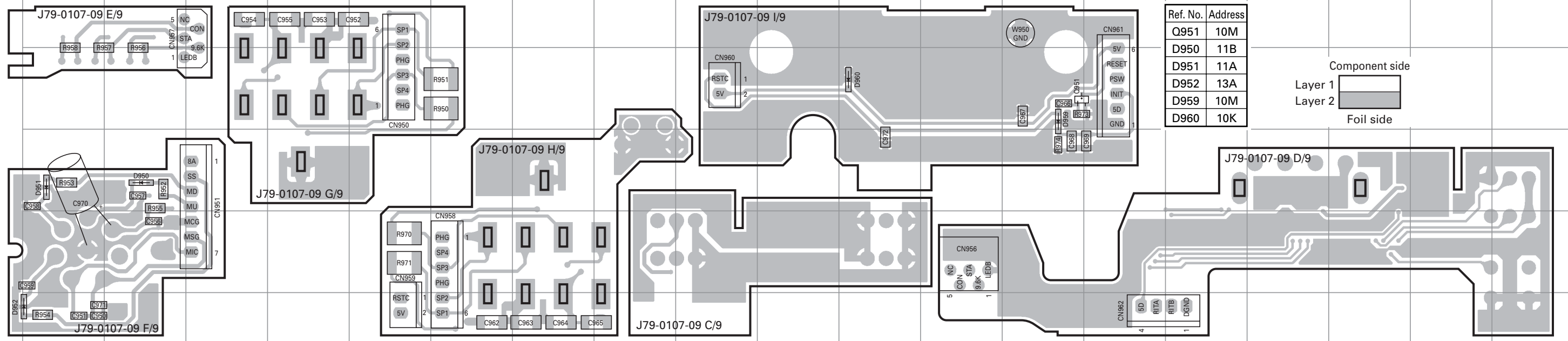

Ref. No.	Address
Q951	10M
D950	11B
D951	11A
D952	13A
D959	10M
D960	10K

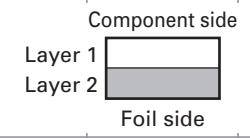

TS-2000/B2000/2000X
 TS-2000S/2000V/2000SX/2000VX **PC BOARD**

TX-RX 2 UNIT (X57-606X-XX) (A/11) 0-00 : J,J1,J2,J3 0-11 : K1,K2,K3 2-71 : E1,E2,E3,E4,E5 Component side view (J79-0108-09 A/11)

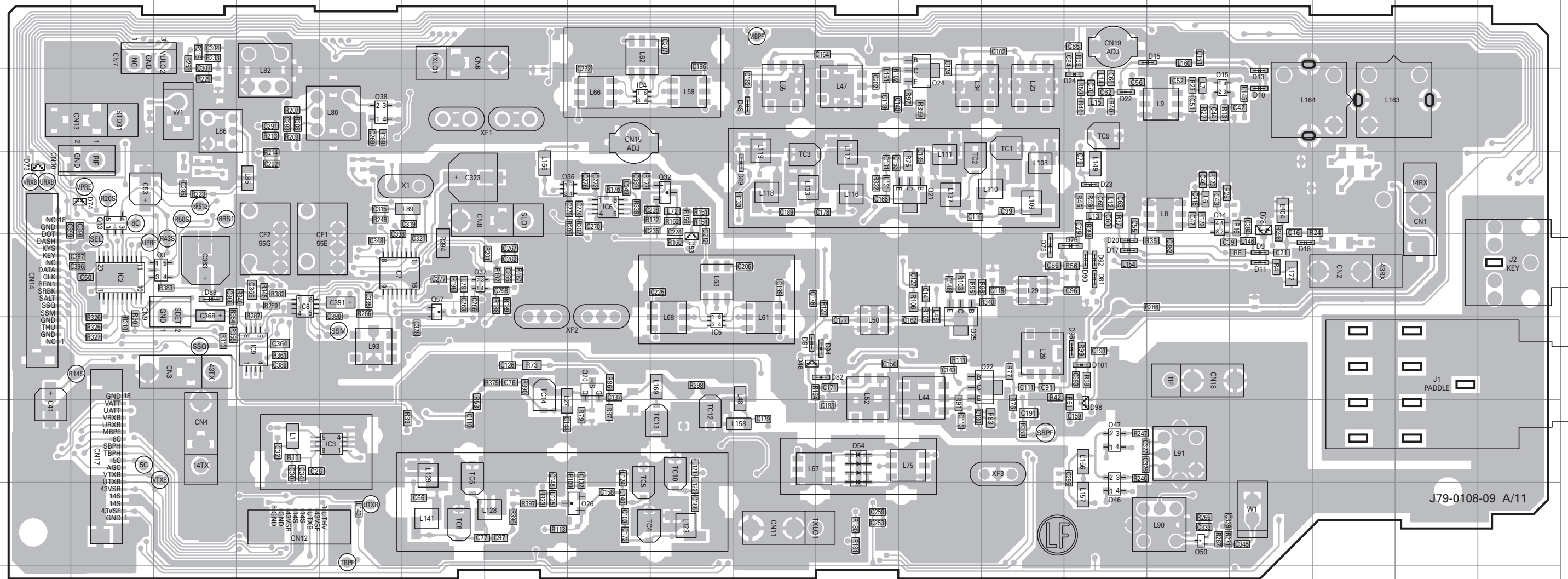

Ref. No.	Address	Ref. No.	Address	Ref. No.	Address	Ref. No.	Address	Ref. No.	Address
IC2	6B	Q20	7H	Q50	9O	D24	4N	D82	7K
IC3	8E	Q21	5L	Q57	6F	D46	7J	D89	6C
IC4	4H	Q22	7M	D9	6P	D48	4J	D90	6N
IC5	7I	Q24	4L	D10	4P	D49	5J	D91	7J
IC6	5H	Q25	7L	D11	6P	D53	6I	D92	6N
IC7	6E	Q26	9H	D13	4P	D54	8K	D94	7K
IC8	6D	Q32	5I	D15	3O	D73	5A	D96	7N
IC9	7D	Q36	5H	D17	6N	D74	5B	D98	8N
Q3	6C	Q37	6F	D18	6P	D75	6M	D101	7N
Q13	5B	Q38	4E	D20	6N	D76	6N		
Q14	5O	Q46	9N	D22	4N	D78	5P		
Q15	4O	Q47	8N	D23	5N	D81	6N		

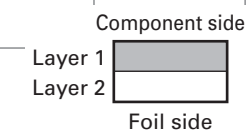

TX-RX 2 UNIT (X57-606X-XX) (A/11) 0-00 : J,J1,J2,J3 0-11 : K1,K2,K3 2-71 : E1,E2,E3,E4,E5 Foil side view (J79-0108-09 A/11)

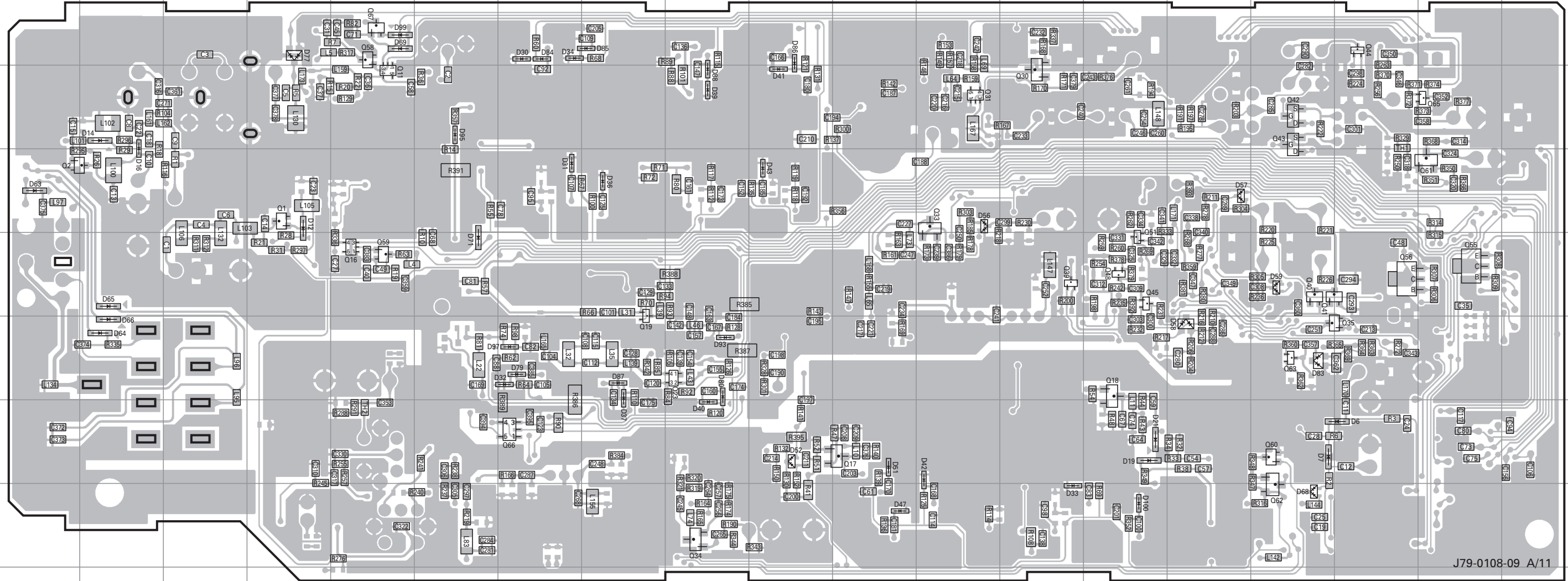

J79-0108-09 A/11

Ref. No.	Address	Ref. No.	Address	Ref. No.	Address	Ref. No.	Address	Ref. No.	Address	Ref. No.	Address	Ref. No.	Address
Q1	5D	Q35	7Q	Q58	3E	D14	4B	D40	8I	D64	7B	D86	3J
Q2	5A	Q39	6M	Q59	6E	D16	5B	D41	4J	D65	6B	D87	7H
Q11	4E	Q40	6P	Q60	8P	D19	8N	D42	8L	D66	7B	D88	4I
Q16	6E	Q41	6P	Q61	5R	D21	8N	D43	5J	D68	9P	D93	7I
Q17	8K	Q42	4P	Q62	9P	D30	3G	D47	9K	D69	3E	D95	4F
Q18	7N	Q43	4P	Q63	7P	D31	5G	D51	8K	D71	6F	D97	7G
Q19	7H	Q44	3Q	Q65	4R	D32	7G	D52	8J	D77	3D	D99	3E
Q23	7I	Q45	6N	Q66	8G	D33	9M	D56	5L	D79	7G	D100	9N
Q30	4M	Q48	6N	Q67	3E	D34	3G	D57	5O	D80	7I		
Q31	4L	Q51	6N	D6	8Q	D36	5H	D58	7O	D83	7P		
Q33	5L	Q55	6R	D7	8P	D37	8H	D59	6P	D84	3G		
Q34	9I	Q56	6Q	D12	5D	D39	4I	D63	5A	D85	3H		

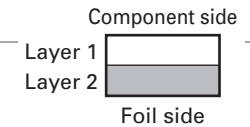

TS-2000/B2000/2000X
 TS-2000S/2000V/2000SX/2000VX **PC BOARD**

TX-RX 2 UNIT (X57-606X-XX) (B/11) 0-00 : J,J1,J2,J3 0-11 : K1,K2,K3 2-71 : E1,E2,E3,E4,E5 Component side view (J79-0108-09 B/11)

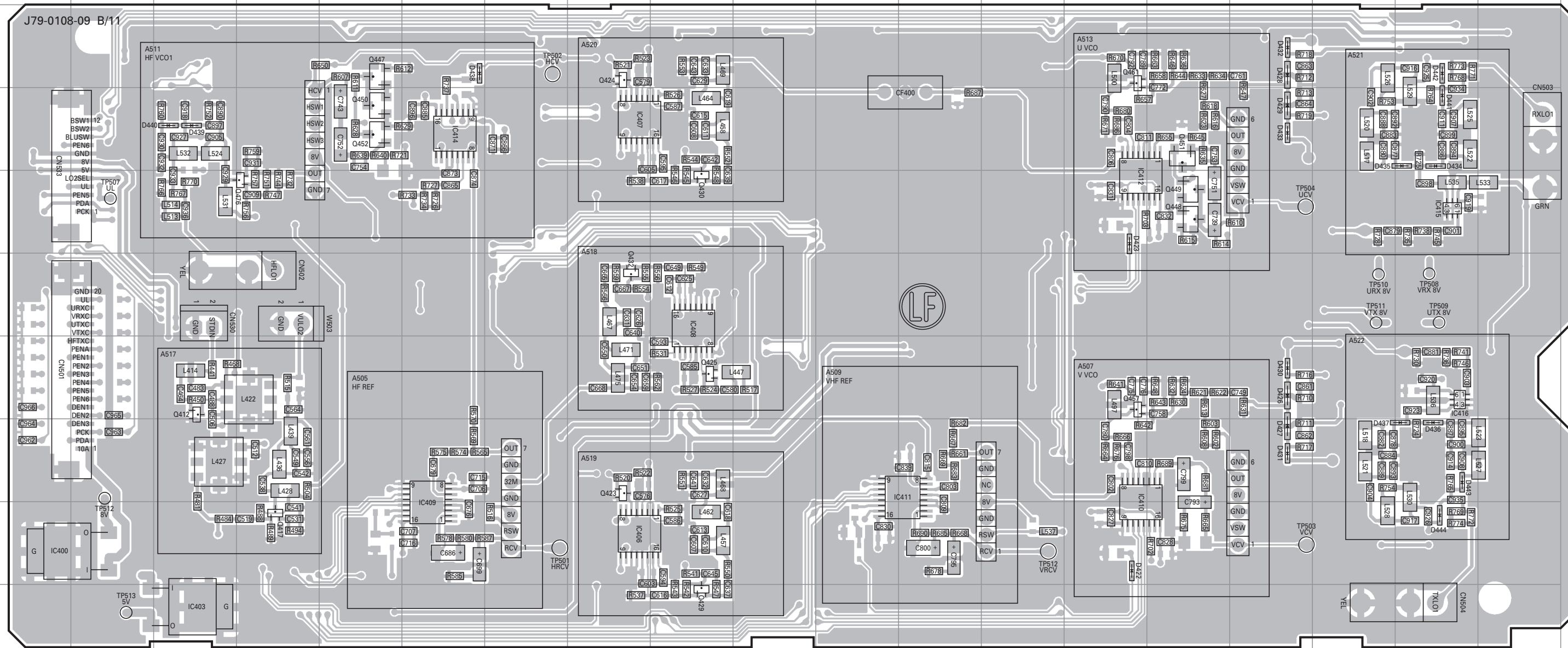

Ref. No.	Address	Ref. No.	Address	Ref. No.	Address	Ref. No.	Address	Ref. No.	Address
IC400	9A	IC416	7R	Q449	5O	D428	3P	D439	4C
IC403	10C	Q412	7C	Q450	4E	D429	4P	D440	4C
IC406	9H	Q417	9D	Q451	4O	D430	7P	D441	4R
IC407	4H	Q423	8H	Q452	4E	D431	8P	D442	3R
IC408	6I	Q424	3H	Q457	7N	D432	3P	D443	8R
IC409	9F	Q425	7I	Q461	3N	D433	4P	D444	9R
IC410	9N	Q429	10I	Q476	5D	D434	4R		
IC411	8L	Q430	5I	D422	9N	D435	4R		
IC412	5N	Q432	6H	D423	5N	D436	8R		
IC414	4F	Q447	3E	D426	7P	D437	8R		
IC415	5R	Q448	5O	D427	8P	D438	3F		

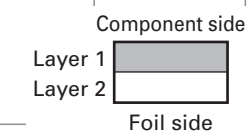

TX-RX 2 UNIT (X57-606X-XX) (B/11) 0-00 : J,J1,J2,J3 0-11 : K1,K2,K3 2-71 : E1,E2,E3,E4,E5 Foil side view (J79-0108-09 B/11)

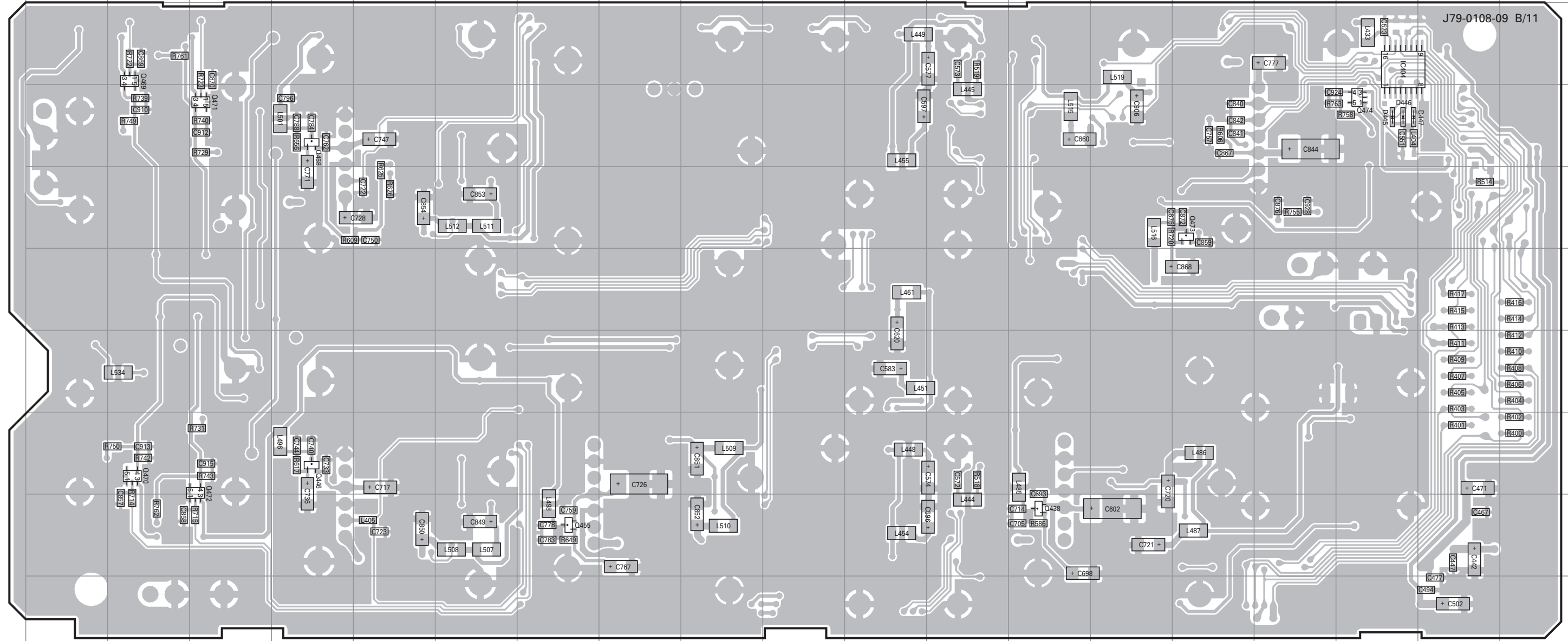

Ref. No.	Address	Ref. No.	Address
IC404	3Q	Q471	4C
Q438	9M	Q472	8C
Q446	8D	Q473	5O
Q455	9G	Q474	4Q
Q458	4D	D445	4Q
Q469	3B	D446	4Q
Q470	8B	D447	4Q

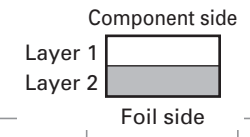

TS-2000/B2000/2000X
TS-2000S/2000V/2000SX/2000VX **PC BOARD**

TX-RX 2 UNIT (X57-606X-XX) (C,D,E,G,H,I,J,K/11) 0-00 : J,J1,J2,J3 0-11 : K1,K2,K3 2-71 : E1,E2,E3,E4,E5 Component side view (J79-0108-09 C,D,E,G,H,I,J,K/11)

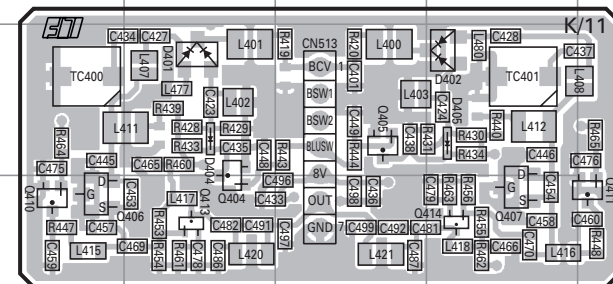
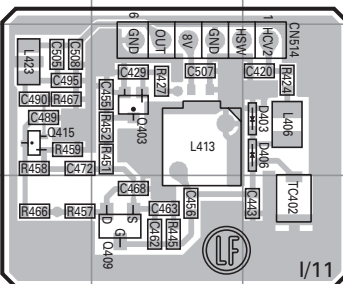
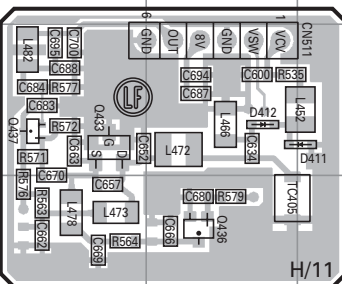
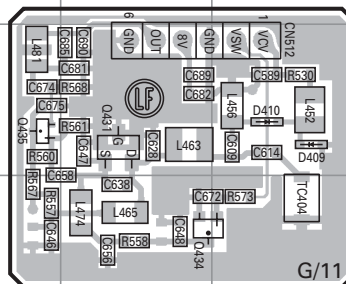
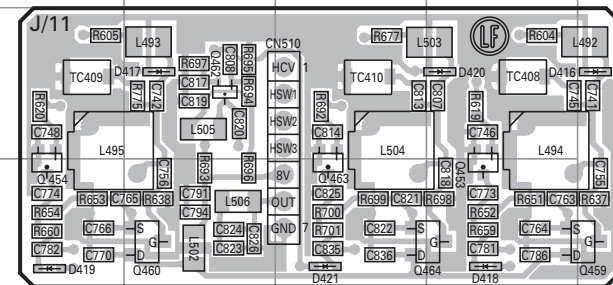
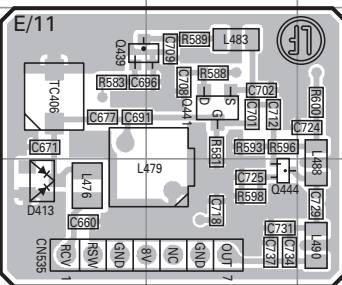
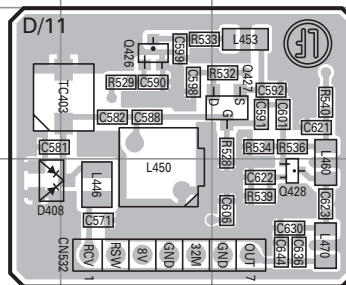
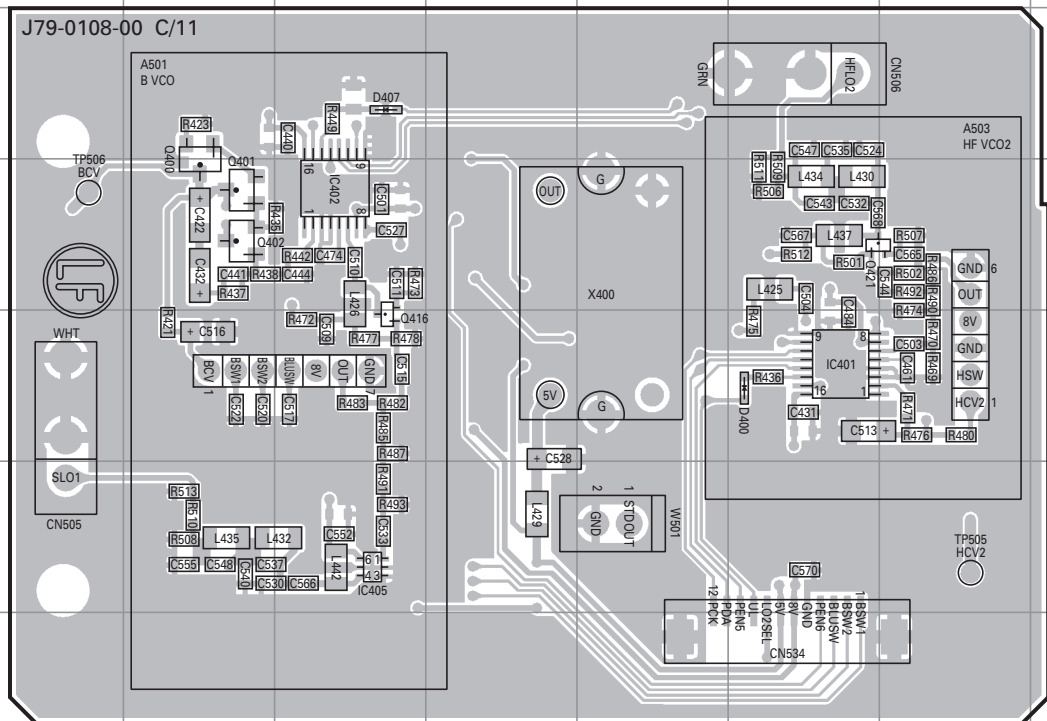

Ref. No.	Address	Ref. No.	Address	Ref. No.	Address	Ref. No.	Address	Ref. No.	Address	Ref. No.	Address	Ref. No.	Address	Ref. No.	Address	Ref. No.	Address	Ref. No.	Address	Ref. No.	Address		
IC401	4F	Q402	3B	Q407	6S	Q414	6S	Q427	2J	Q435	5H	Q444	3L	Q462	2Q	D402	5S	D407	2C	D412	5L	D419	3P
IC402	3C	Q403	5N	Q409	6N	Q415	5M	Q428	3J	Q436	6L	Q453	3S	Q463	3R	D403	5O	D408	3H	D413	3K	D420	2S
IC405	5C	Q404	6Q	Q410	6P	Q416	4C	Q431	5I	Q437	5K	Q454	3P	Q464	3S	D404	5Q	D409	5J	D416	2S	D421	3R
Q400	3B	Q405	5R	Q411	6S	Q421	3F	Q433	5K	Q439	2K	Q459	3S	D400	4F	D405	5S	D410	5J	D417	2Q		
Q401	3B	Q406	6P	Q413	6Q	Q426	2I	Q434	6I	Q441	2L	Q460	3Q	D401	5Q	D406	5O	D411	5M	D418	3S		

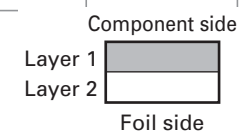

TX-RX 2 UNIT (X57-606X-XX) (C,D,E,G,H,I,J,K/11) 0-00 : J,J1,J2,J3 0-11 : K1,K2,K3 2-71 : E1,E2,E3,E4,E5 Foil side view (J79-0108-09 C,D,E,G,H,I,J,K/11)

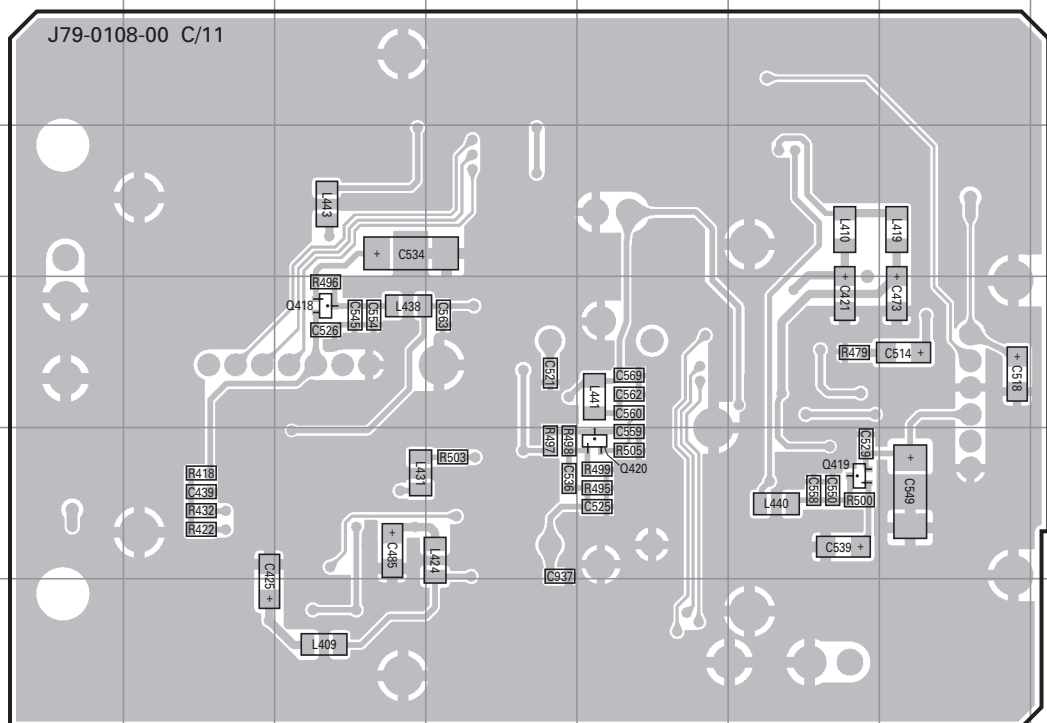

TX-RX 3 UNIT (UT-20) (X57-607X-XX) 0-00 : J2,J3,K3 2-71 : E5 Component side view (J79-0109-09)

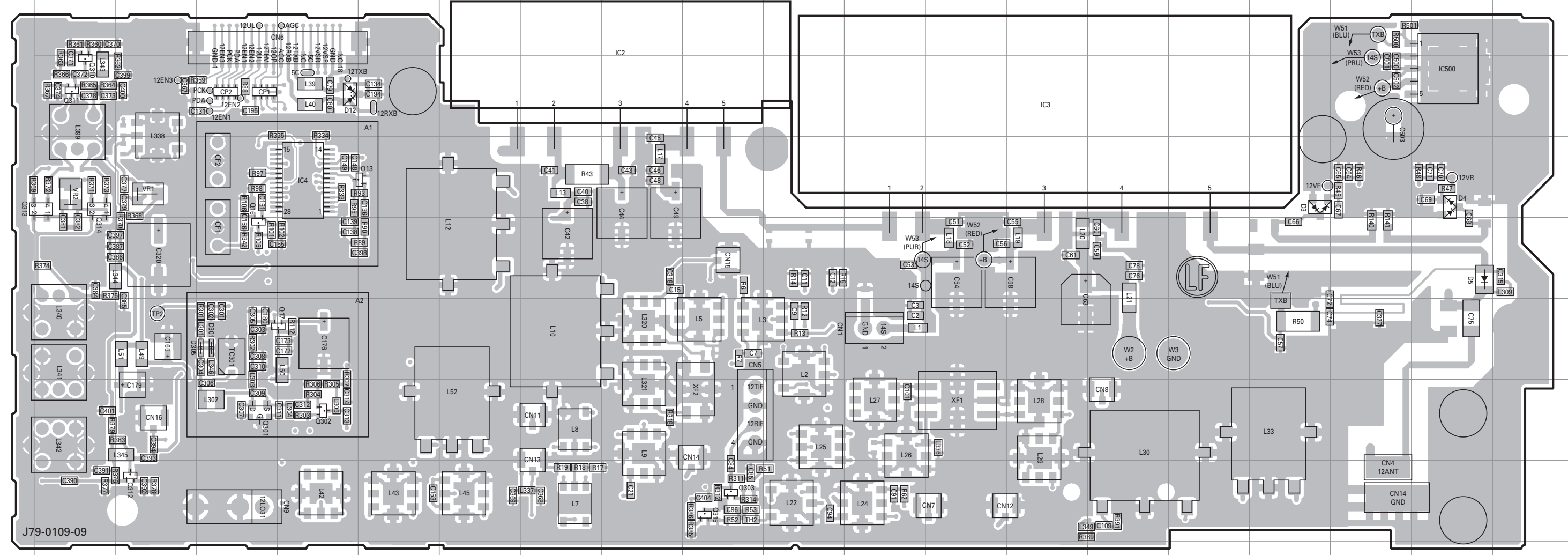

J79-0109-09

Ref No.	Address	Ref No.	Address	Ref No.	Address	Ref No.	Address	Ref No.	Address
IC2	3H	Q16	6C	Q310	4A	Q315	9I	D301	7C
IC3	4M	Q17	7D	Q311	4A	D3	5P	D305	7C
IC4	5D	Q301	8C	Q312	9B	D4	5R		
IC500	4R	Q302	8D	Q313	5A	D5	6R		
Q13	5E	Q303	9I	Q314	5A	D12	4D		

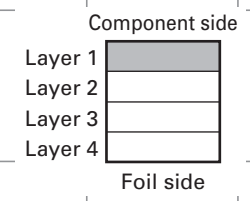

TS-2000/B2000/2000X
 TS-2000S/2000V/2000SX/2000VX **PC BOARD**

TX-RX 3 UNIT (UT-20) (X57-607X-XX) 0-00 : J2,J3,K3 2-71 : E5 Foil side view (J79-0109-09)

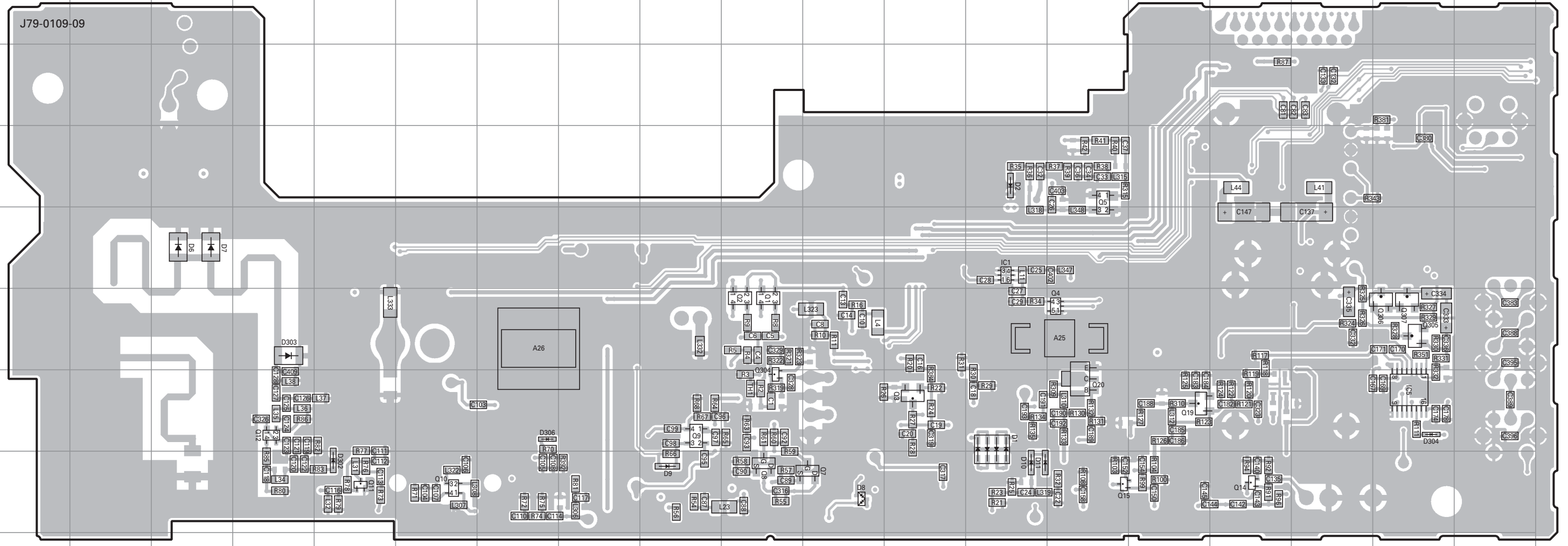

Ref No.	Address	Ref No.	Address	Ref No.	Address	Ref No.	Address	Ref No.	Address	Ref No.	Address	Ref No.	Address
IC1	6M	Q4	7N	Q10	9F	Q19	8O	Q307	7R	D8	9K	D303	7D
IC5	8R	Q5	5N	Q11	9E	Q20	8N	D1	8M	D9	9I	D304	8R
Q1	7J	Q7	9K	Q12	8D	Q304	8J	D2	5M	D10	9M	D306	8G
Q2	7J	Q8	9J	Q14	9P	Q305	7R	D6	6C	D11	9M		
Q3	8L	Q9	8I	Q15	9N	Q306	7R	D7	6C	D302	9E		

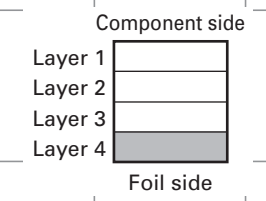

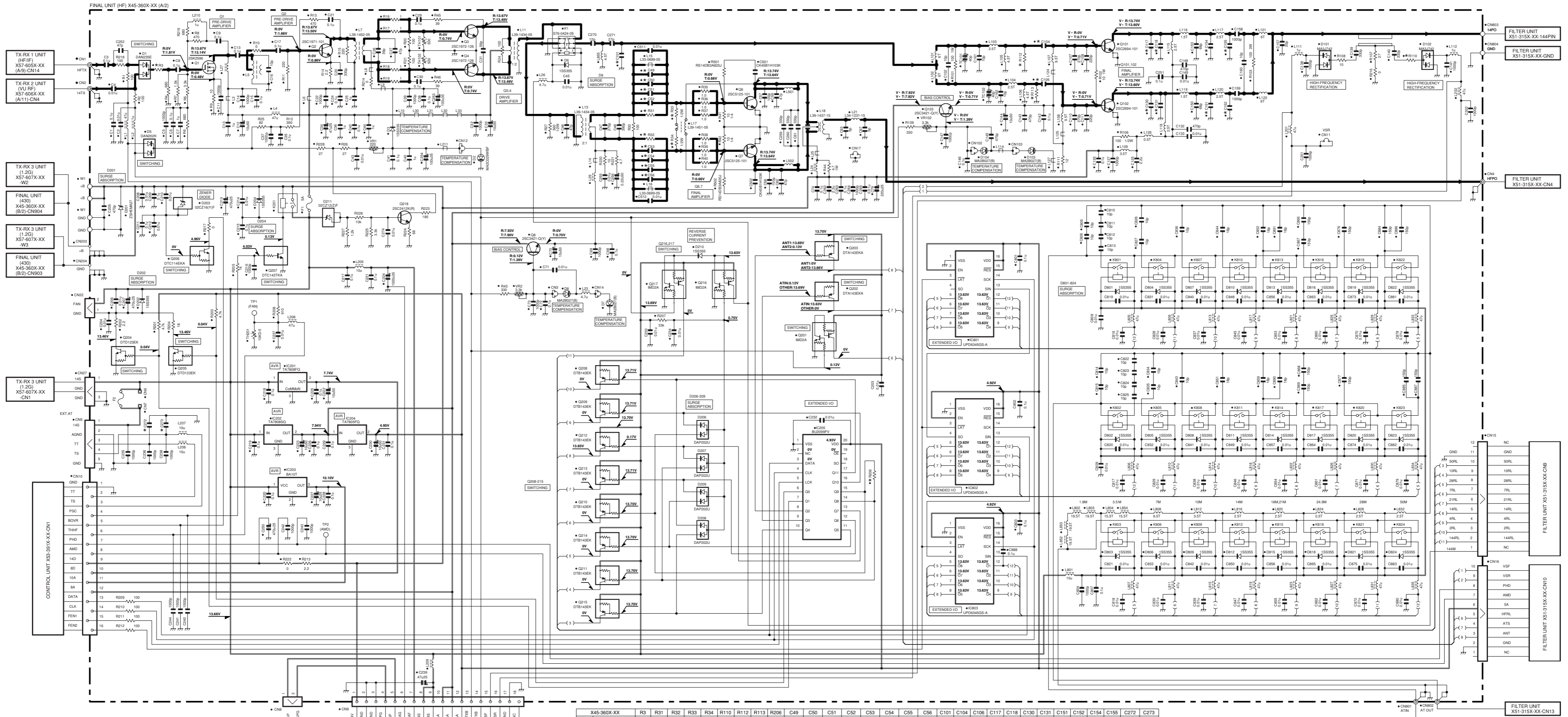

	R3	R31	R32	R33	R34	R110	R112	R113	R206	C49	C50	C51	C52	C53	C54	C55	C56	C101	C104	C106	C117	C118	C130	C131	C151	C152	C154	C155	C272	C273		
0-00	J1J2	15	1	1	8.2	8.2	560	NO	NO	NO	2700p	2700p	2700p	2700p	2700p	2700p	2700p	2700p	2700p	2700p	2700p	2700p	2700p	2700p	2700p	2700p	2700p	2700p	2700p	2700p	2700p	
0-01	J1,J3	100	2.2	2.2	3.3	3.3	47	22	22	10	470p	470p	NO	NO	470p	470p	NO	56p	82p	82p	NO	NO	NO	NO	15p	NO	15p	NO	NO	NO	NO	NO
0-11	K1,K2,K3	15	1	1	8.2	8.2	560	NO	NO	NO	2700p	2700p	2700p	2700p	2700p	2700p	2700p	2700p	2700p	2700p	2700p	2700p	2700p	2700p	2700p	2700p	2700p	2700p	2700p	2700p	2700p	2700p
2-71	E1,E2,E3,E4,E5	15	1	1	8.2	8.2	560	NO	NO	NO	2700p	2700p	2700p	2700p	2700p	2700p	2700p	2700p	2700p	2700p	2700p	2700p	2700p	2700p	2700p	2700p	2700p	2700p	2700p	2700p	2700p	2700p

Note : The components marked with a dot (•) are parts of layer 1.

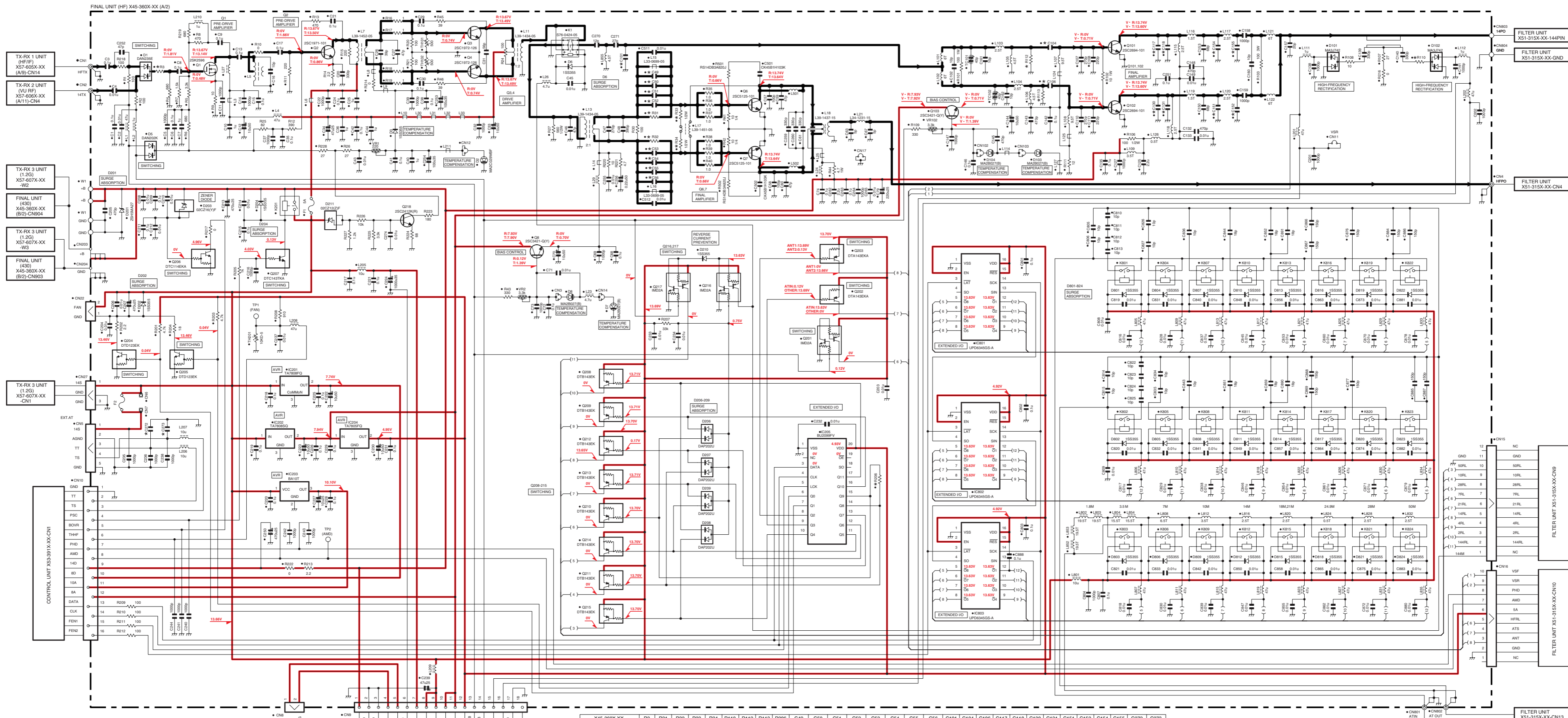

TX-RX 1 UNIT (HF/IF) X57-605X-XX (A/9)-CN14

TX-RX 2 UNIT (VU) X57-600X-XX (A/1)-CN4

TX-RX 3 UNIT (1.2G) X57-607X-XX -W2

FINAL UNIT (430) X45-360X-XX (B/2)-CN904

TX-RX 3 UNIT (1.2G) X57-607X-XX -W3

FINAL UNIT (430) X45-360X-XX (B/2)-CN903

TX-RX 3 UNIT (1.2G) X57-607X-XX -CN1

CONTROL UNIT X53-391X-XX-CN1

EXT AT

14S

TT

PSC

BOVR

THIF

PHD

AMD

14D

8D

10A

8A

DATA

CLK

FEN1

FEN2

TX-RX 1 UNIT (HF/IF) X57-605X-XX (A/9)-CN29

	X45-360X-XX	R3	R31	R32	R33	R34	R110	R112	R113	R206	C49	C50	C51	C52	C53	C54	C55	C56	C101	C104	C106	C117	C118	C130	C131	C151	C152	C154	C155	C272	C273
0-00	J,J2	15	1	1	8.2	8.2	560	NO	NO	10	2700p	2700p	2700p	2700p	2700p	2700p	2700p	2700p	39p	100p	100p	180p	150p	150p	180p	NO	4p	NO	4p	NO	NO
0-01	J1,J3	100	2.2	2.2	3.3	3.3	47	22	22	10	470p	470p	NO	NO	NO	NO	NO	NO	56p	82p	82p	NO	NO	NO	NO	15p	NO	15p	NO	NO	NO
0-11	K1,K2,K3	15	1	1	8.2	8.2	560	NO	NO	10	2700p	2700p	2700p	2700p	2700p	2700p	2700p	2700p	39p	100p	100p	180p	150p	150p	180p	NO	4p	NO	4p	NO	NO
2-71	E1,E2,E3,E4,E5	15	1	1	8.2	8.2	560	NO	NO	NO	2700p	2700p	2700p	2700p	2700p	2700p	2700p	2700p	39p	100p	100p	180p	150p	150p	180p	NO	4p	NO	4p	1000p	1000p

FILTER UNIT X51-315X-XX-144PIN

FILTER UNIT X51-315X-XX-GND

FILTER UNIT X51-315X-XX-CN4

FILTER UNIT X51-315X-XX-CN9

FILTER UNIT X51-315X-XX-CN10

FILTER UNIT X51-315X-XX-CN13

FILTER UNIT X51-315X-XX-CN12

SCHEMATIC DIAGRAM

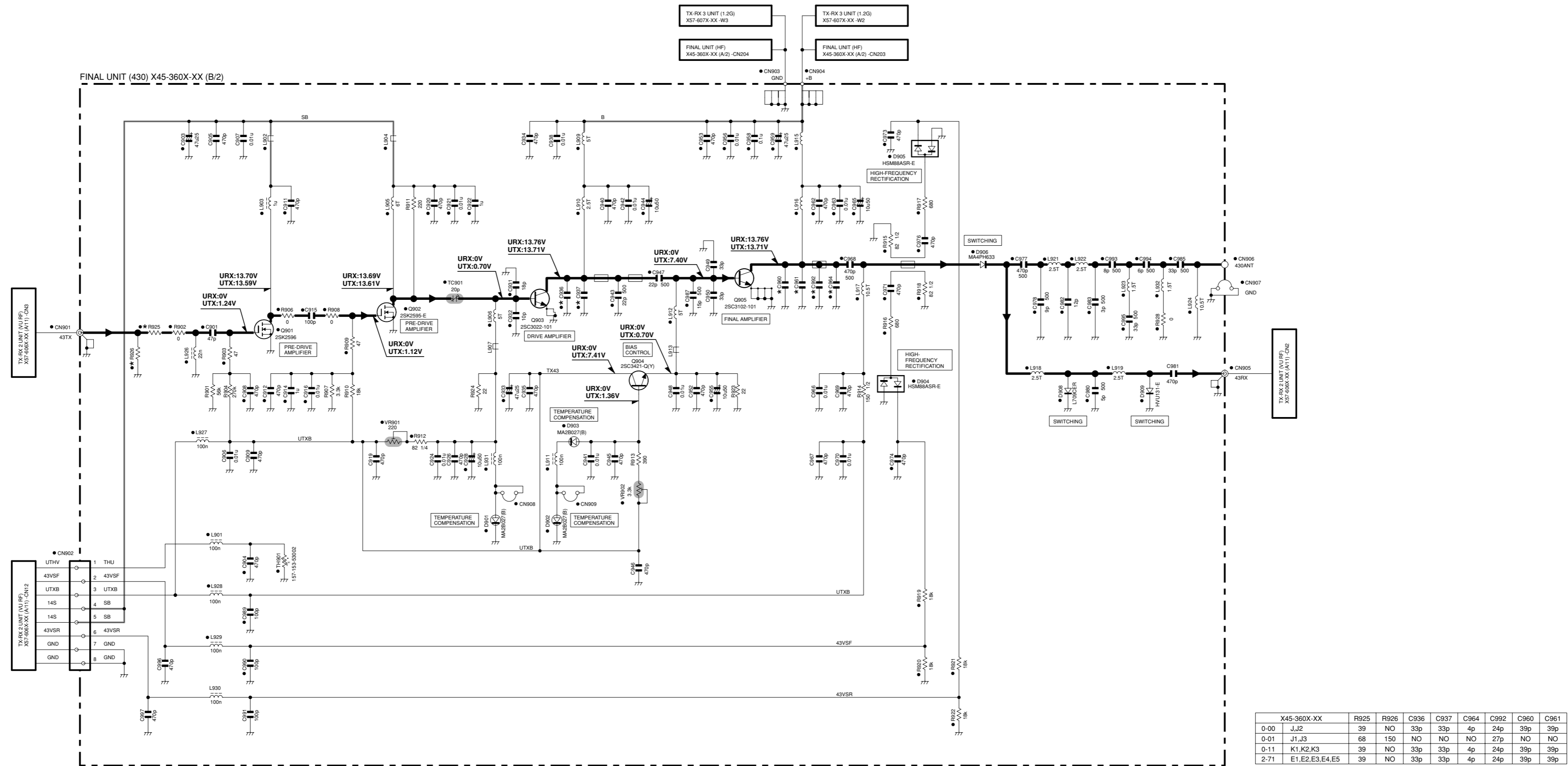

Note : The components marked with a dot (•) are parts of layer 1.

	X45-360X-XX	R925	R926	C936	C937	C964	C992	C960	C961
0-00	J1,J2	39	NO	33p	33p	4p	24p	39p	39p
0-01	J1,J3	68	150	NO	NO	NO	27p	NO	NO
0-11	K1,K2,K3	39	NO	33p	33p	4p	24p	39p	39p
2-71	E1,E2,E3,E4,E5	39	NO	33p	33p	4p	24p	39p	39p

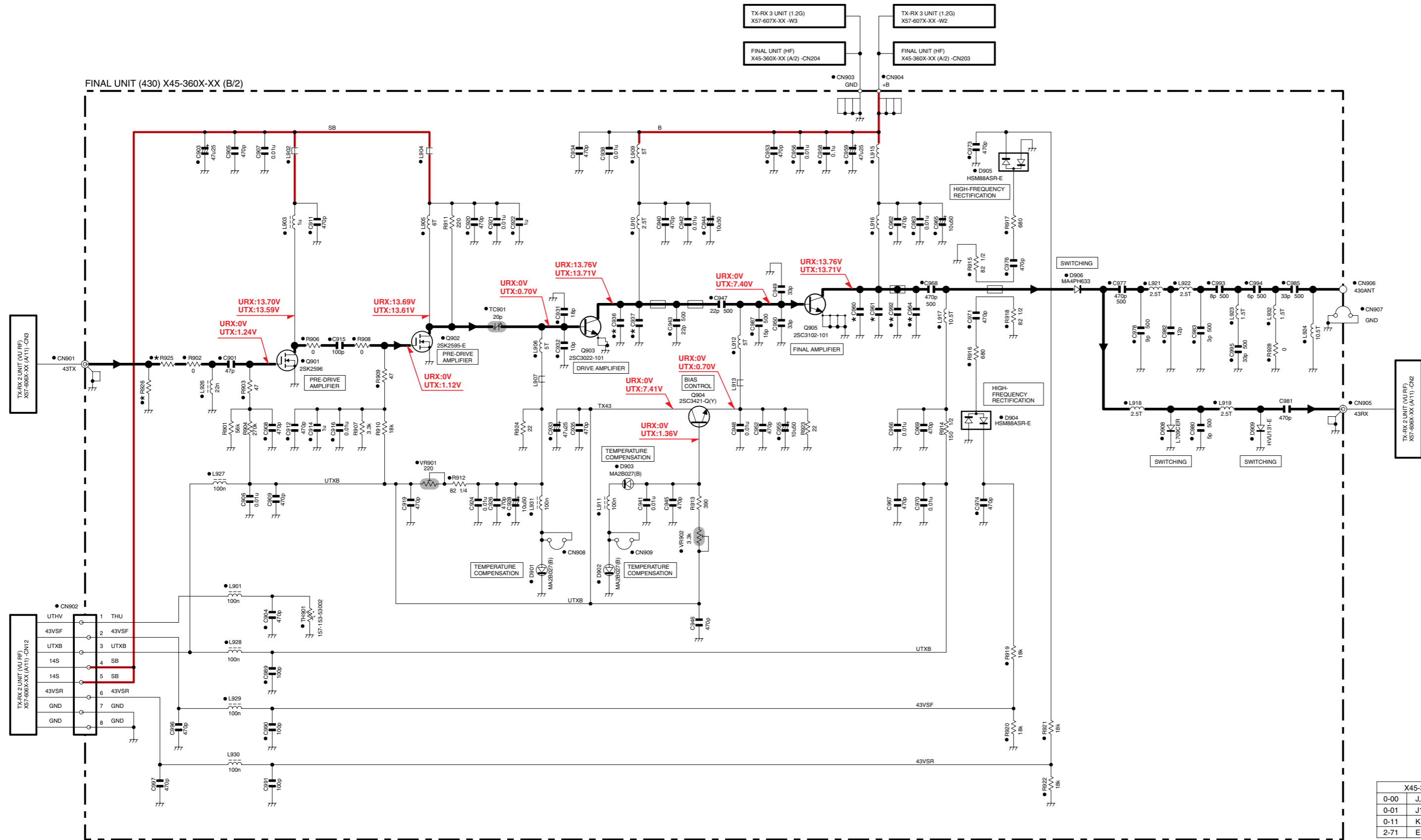

	X45-360X-XX	R925	R926	C936	C937	C964	C992	C960	C961
0-00	J,J2	39	NO	33p	33p	4p	24p	39p	39p
0-01	J1,J3	68	150	NO	NO	NO	27p	NO	NO
0-11	K1,K2,K3	39	NO	33p	33p	4p	24p	39p	39p
2-71	E1,E2,E3,E4,E5	39	NO	33p	33p	4p	24p	39p	39p

SCHEMATIC DIAGRAM

TS-2000/B2000/2000X
TS-2000S/2000V/2000SX/2000VX

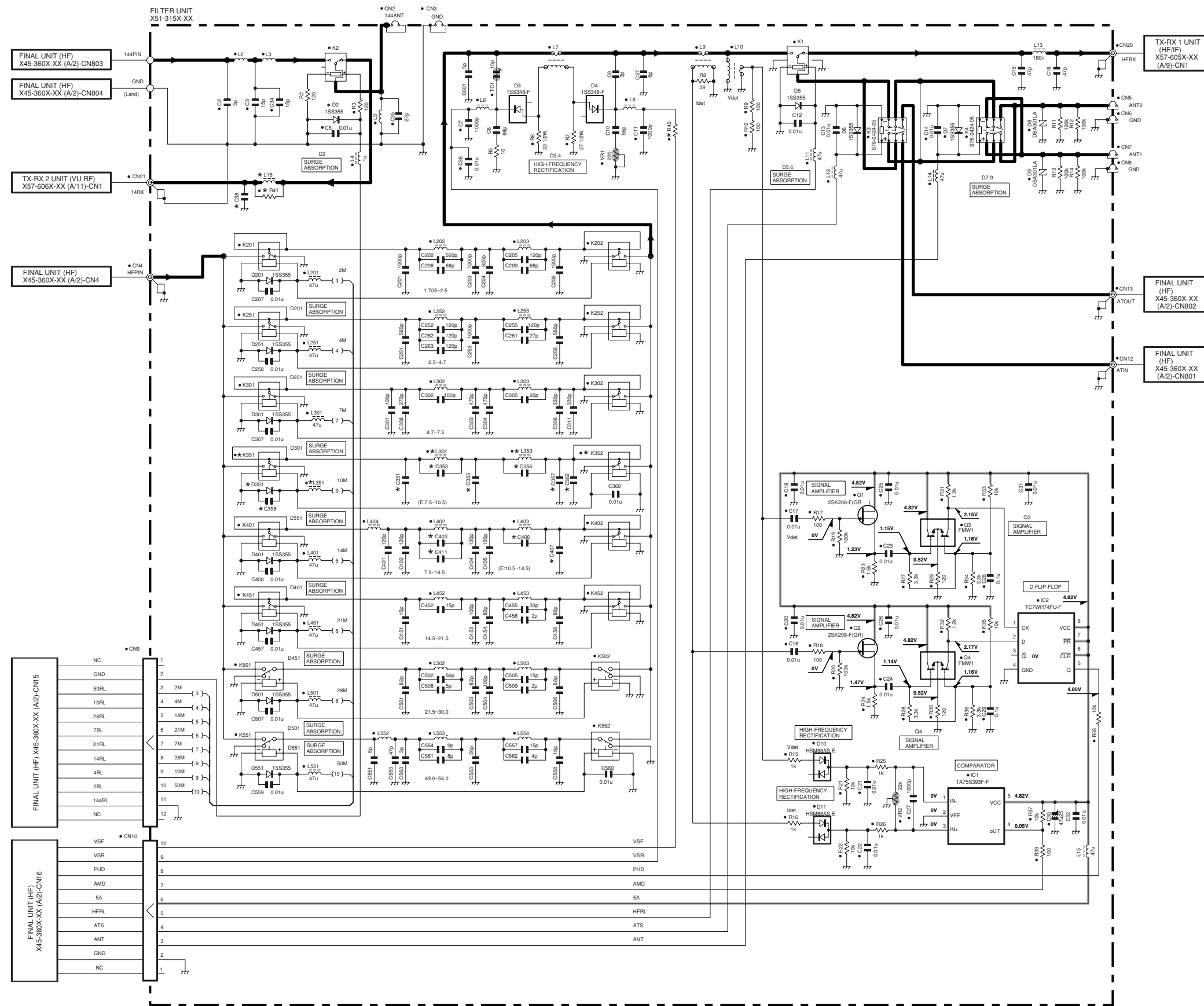

X51-315X-XX	D351	K351	K352	L16	L351	L352	L353	R40	R41	C38	C351	C353	C355	C356	C357	C358	C362	C403	C406	C407	C411	
0-00	J,J2	NO	NO	NO	27n	NO	NO	NO	33k	NO	33p	NO	NO	NO	NO	NO	NO	NO	100p	39p	33p	10p
0-01	J1,J3	NO	NO	NO	27n	NO	NO	NO	NO	NO	NO	NO	NO	NO	NO	NO	NO	NO	100p	39p	33p	10p
0-11	K1,K2,K3	NO	NO	NO	NO	NO	NO	NO	33k	0	NO	NO	NO	NO	NO	NO	NO	NO	100p	39p	33p	10p
2-71	E1,E2,E3,E4,E5	1SS355	S76-0423-05	S76-0423-05	27n	47u	L39-1221-05	L39-1221-05	33k	NO	33p	82p	47p	47p	100p	120p	0.01u	120p	56p	27p	82p	NO

Note : The components marked with a dot (•) are parts of layer 1.

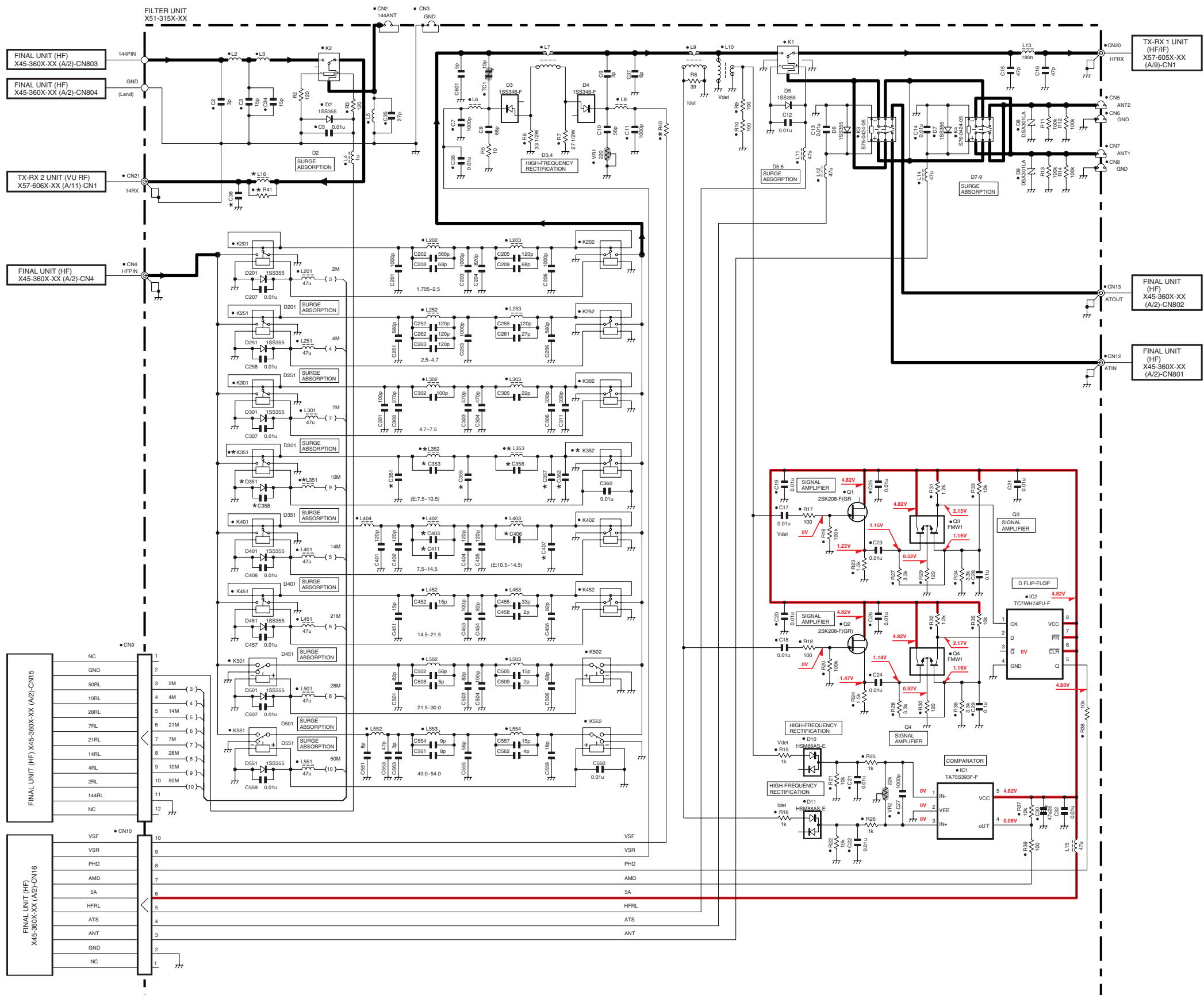

	X51-315X-XX	D351	K351	K352	L16	L351	L352	L353	R40	R41	C38	C351	C353	C355	C356	C357	C358	C362	C403	C406	C407	C411
0-00	J,J2	NO	NO	NO	27n	NO	NO	NO	33k	NO	33p	NO	NO	NO	NO	NO	NO	NO	100p	39p	33p	10p
0-01	J1,J3	NO	NO	NO	27n	NO	NO	NO	NO	NO	33p	NO	NO	NO	NO	NO	NO	NO	100p	39p	33p	10p
0-11	K1,K2,K3	NO	NO	NO	NO	NO	NO	NO	33k	0	NO	NO	NO	NO	NO	NO	NO	NO	100p	39p	33p	10p
2-71	E1,E2,E3,E4,E5	1SS355	S76-0423-05	S76-0423-05	27n	47u	L39-1221-05	L39-1221-05	33k	NO	33p	82p	47p	470p	100p	120p	0.01u	120p	56p	27p	82p	NO

DISPLAY UNIT X54-3320-00

Simulation of a radio display with various indicators and a large digital readout showing '288.100000000'.

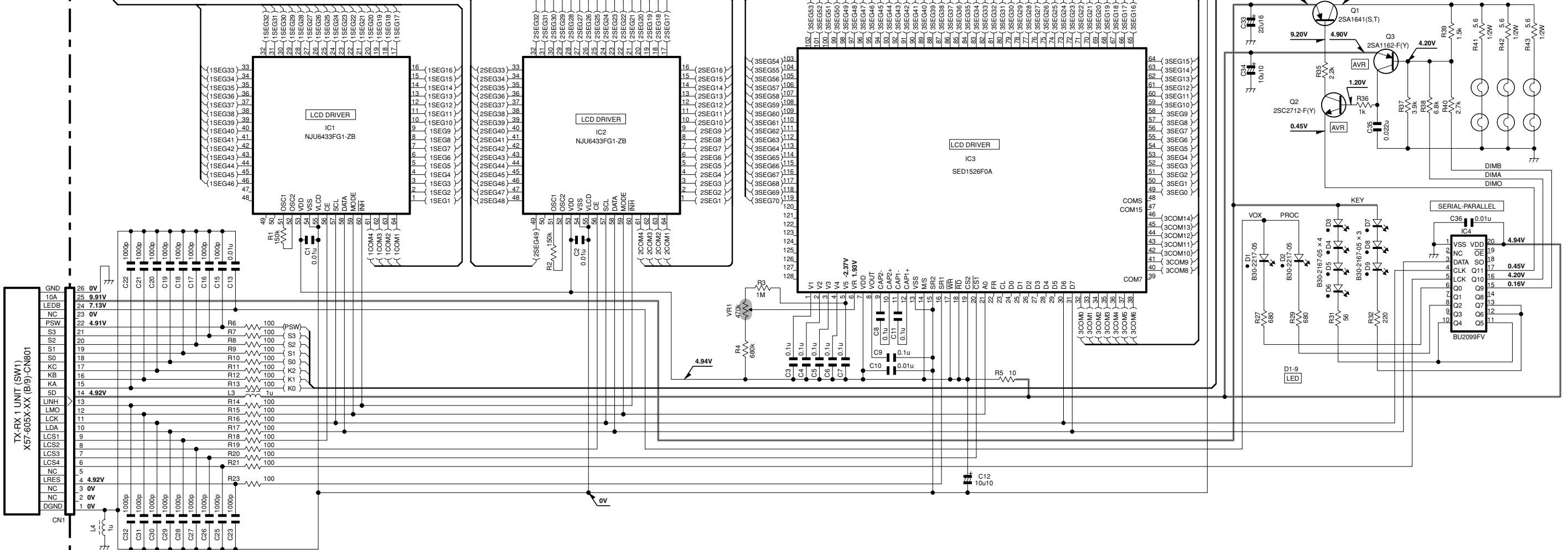
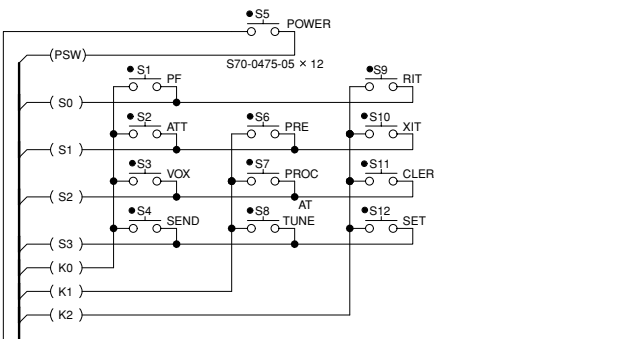
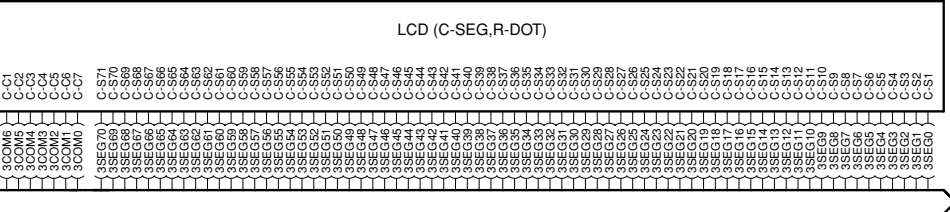
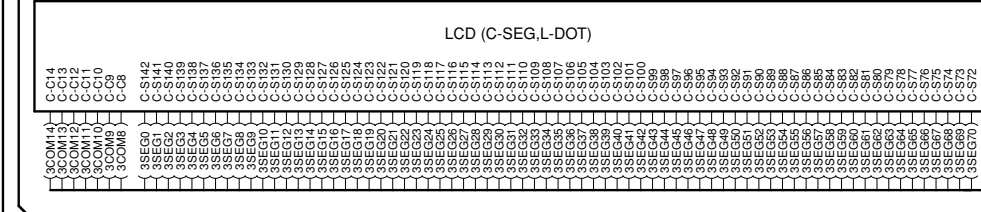
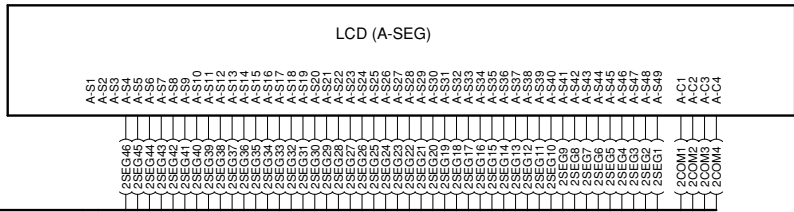
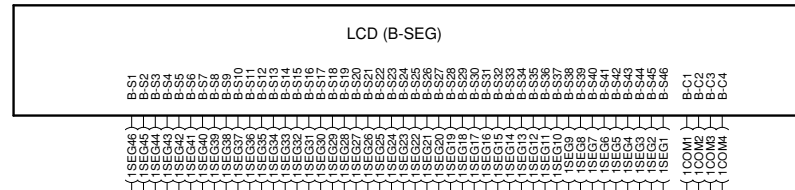

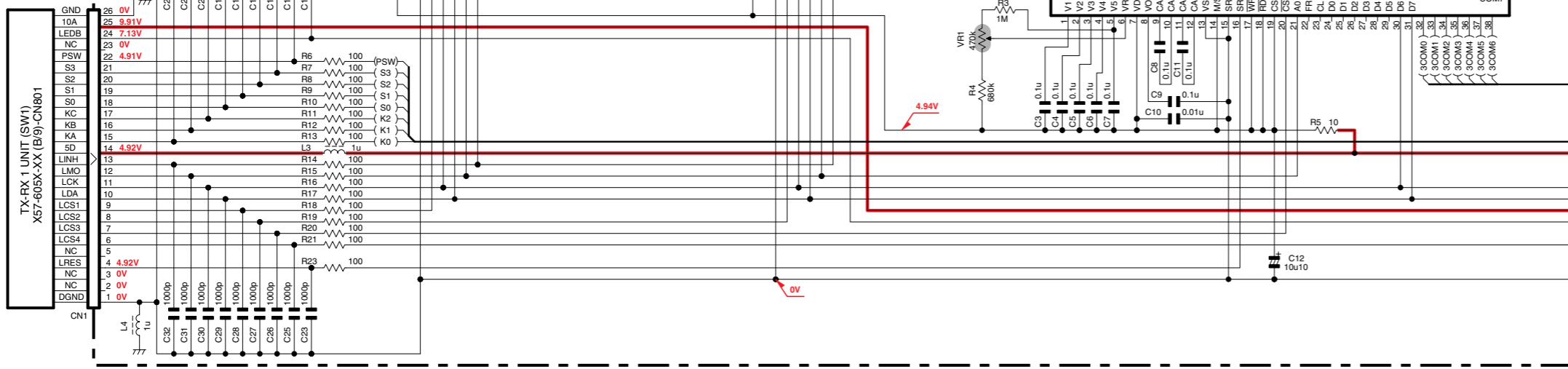
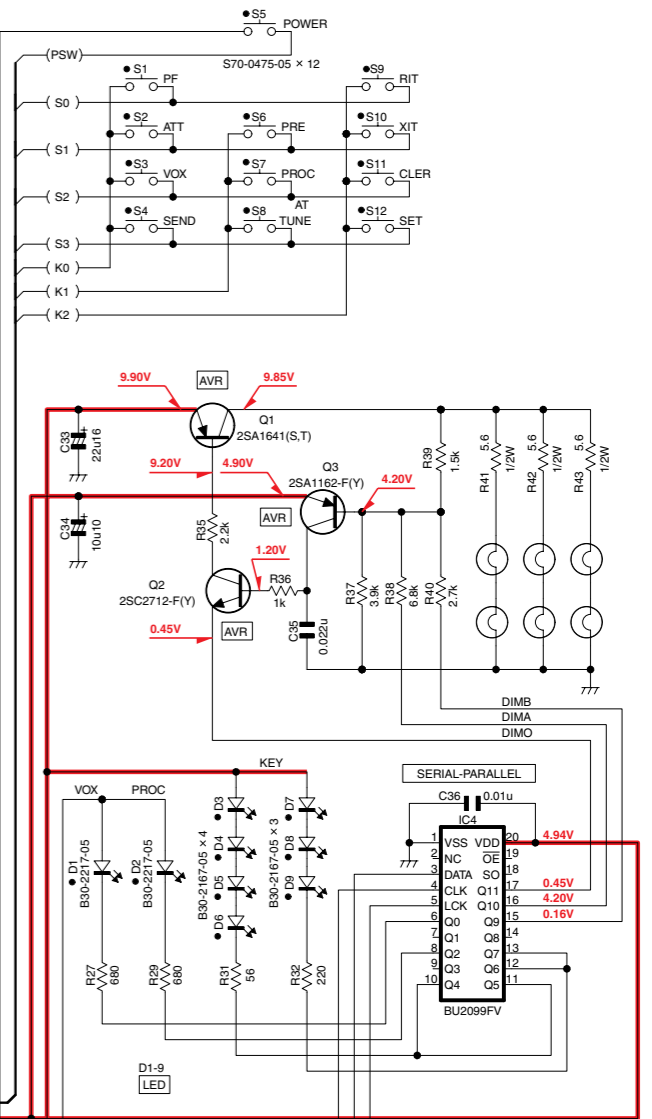
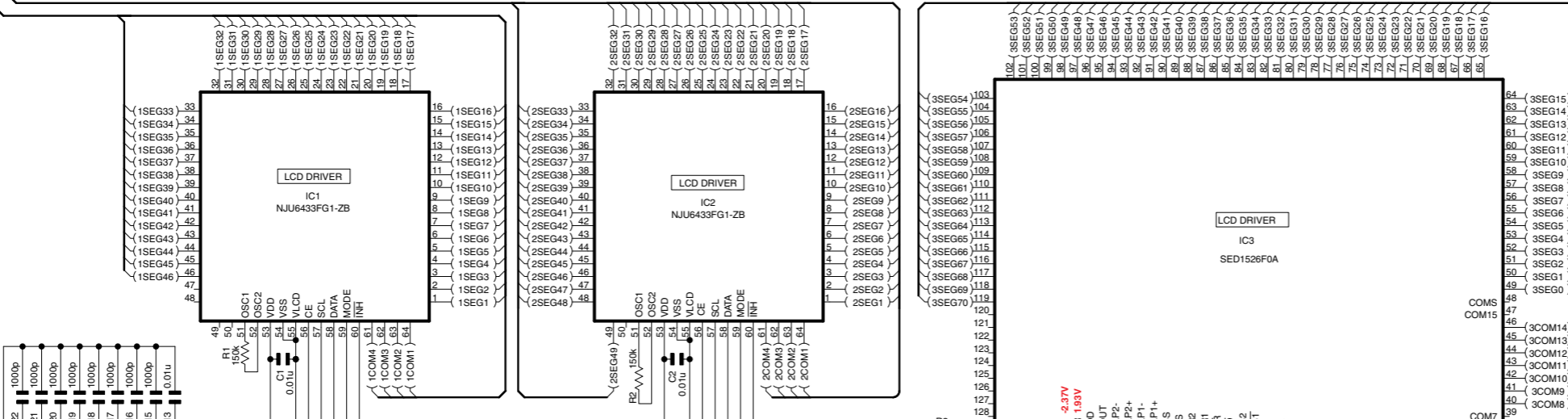
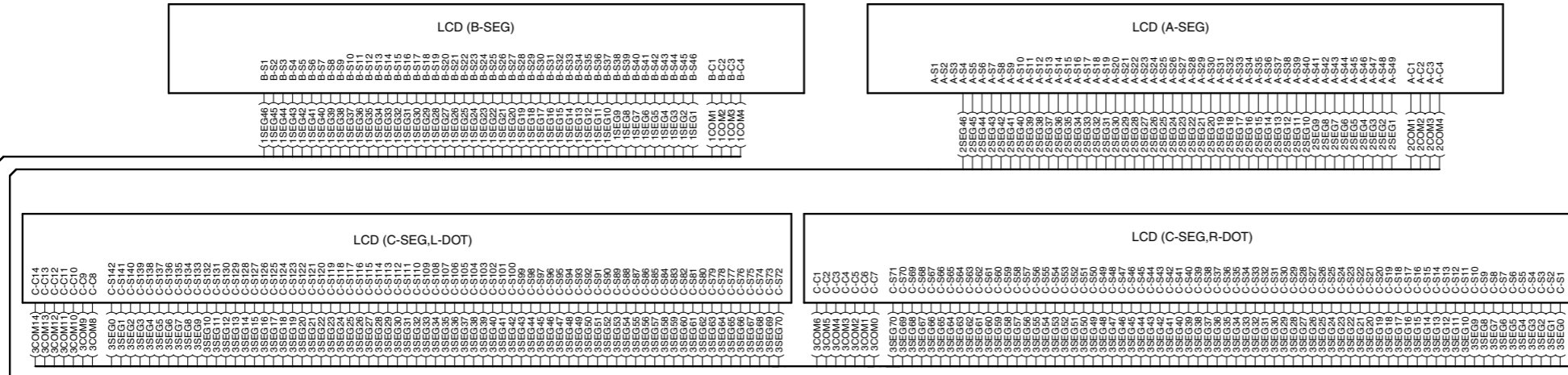

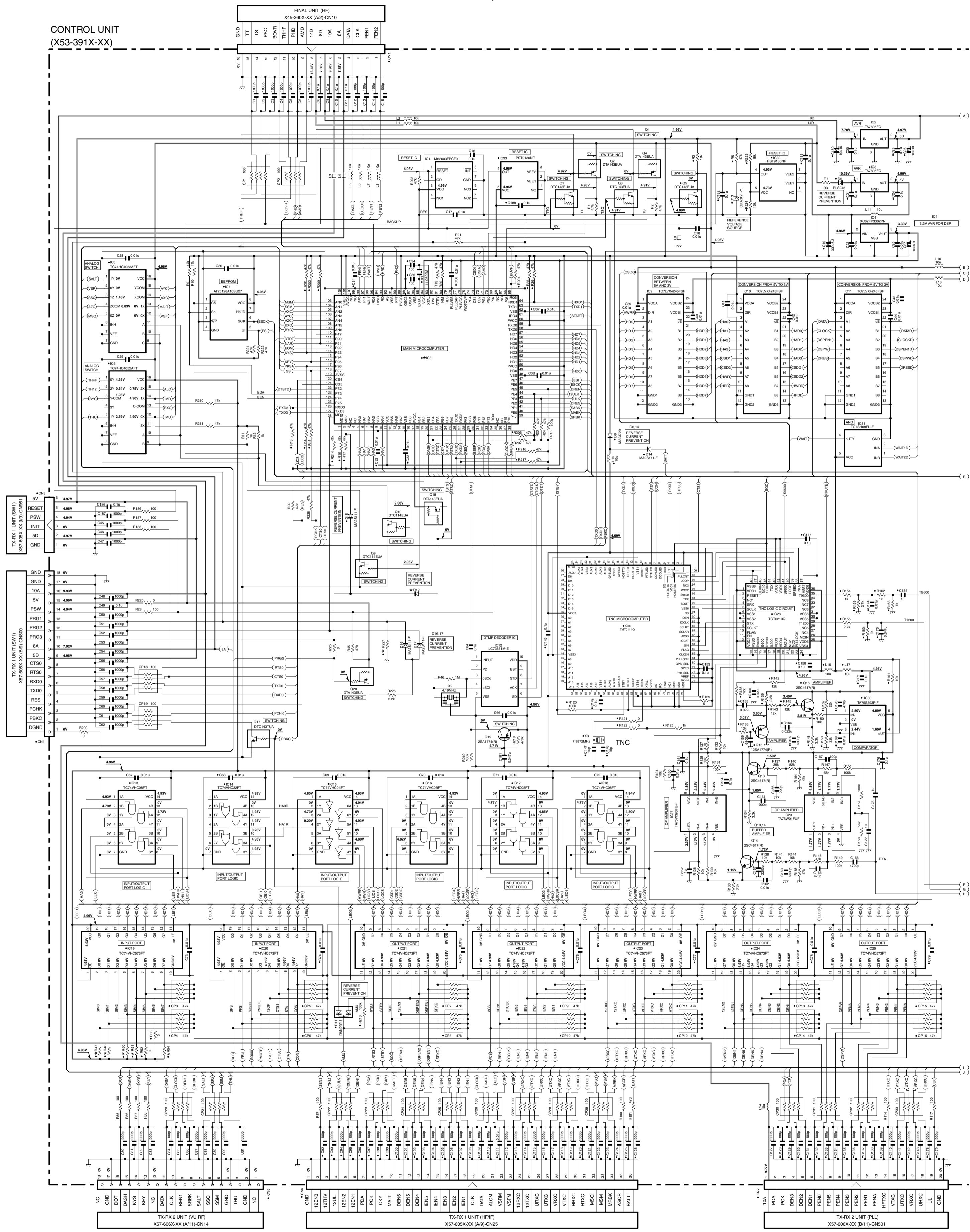

X53-391X-XX	D12	IC8	IC50S	R47	R48	R50	R51	R54	R227	R540	R744
0-00	JJ2	NO	64F2633JXVC	29AL08D90KBGA	NO	NO	0	0	0	NO	10k
0-01	J1J3	NO	64F2633JXZC	29AL08D90KBGA	NO	NO	0	0	0	NO	10k
0-11	K1K2K3	MA2S111-F	64F2633JXUC	29AL08D90KBFA	NO	NO	NO	NO	NO	NO	10k
2-71	E1E2E5	MA2S111-F	64F2633JXUC	29AL08D90KBFA	NO	NO	NO	NO	NO	NO	10k
2-72	E3E4	MA2S111-F	64F2633JXUC	29AL08D90KBFA	0	NO	NO	NO	0	NO	10k

Note : Components marked with a dot (•) are parts of layer 1.

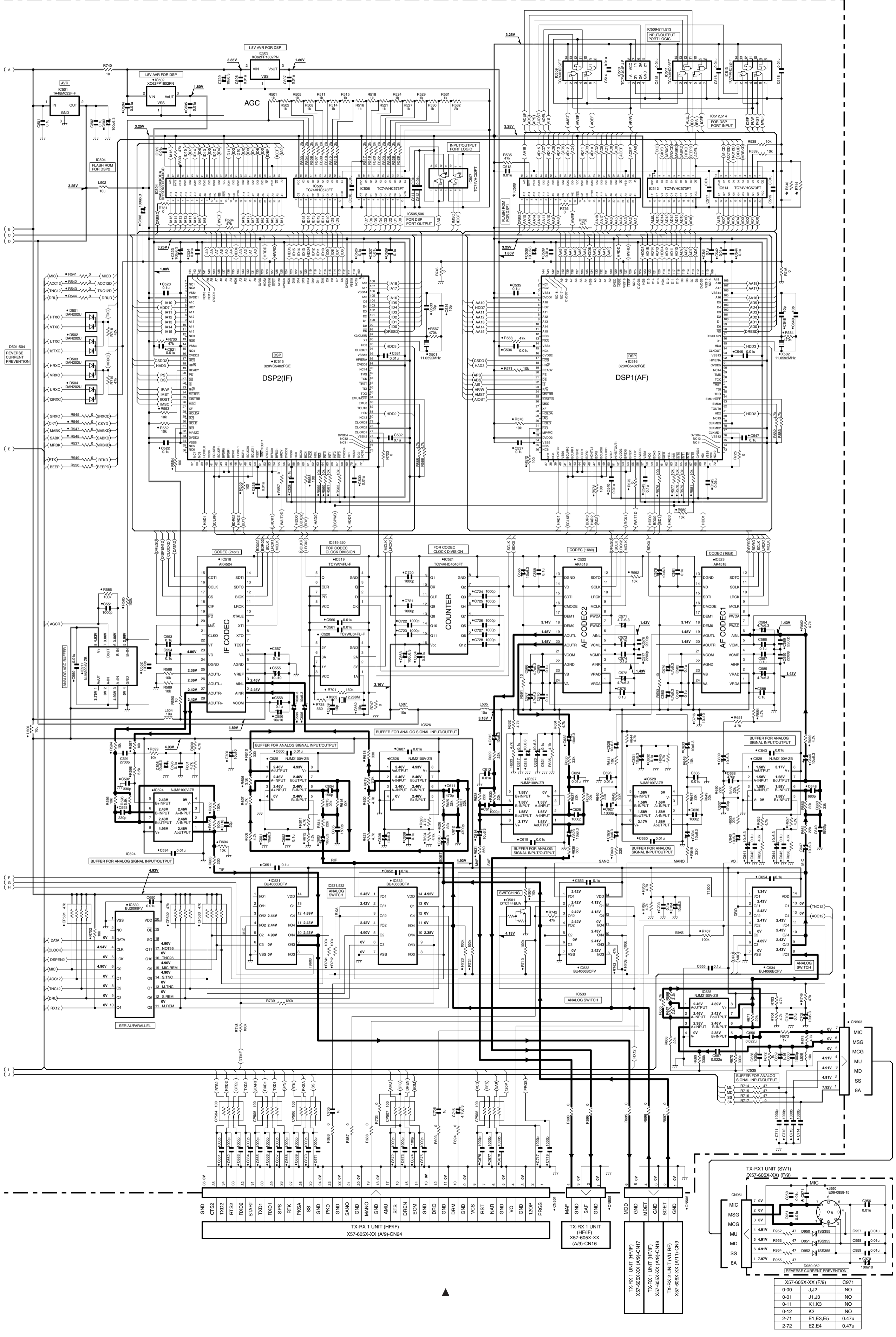

CONTROL UNIT
(X53-391X-XX)

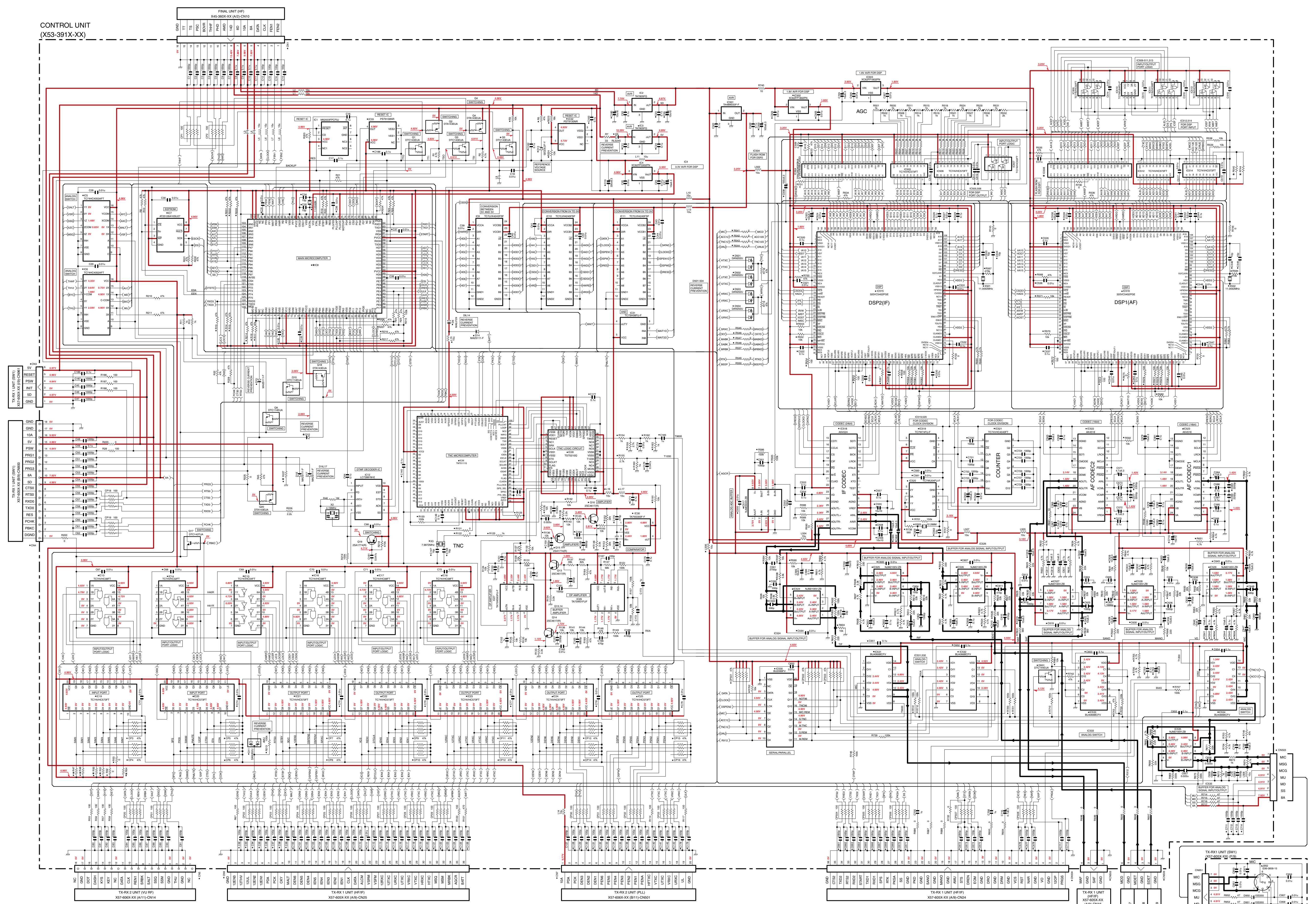

X53-391X-XX	D12	IC6	IC508	R47	R48	R50	R51	R54	R227	R540	R744
0-00	J42	NO	64F2633JVC	29AL08090K9GA	NO	NO	0	0	0	0	10K
0-01	J13	NO	64F2633JVC	29AL08090K9GA	0	0	0	NO	NO	0	NO
0-11	K1 K2 K3	MA2511-F	64F2633JVC	29AL08090K9FA	NO	NO	NO	NO	NO	10K	NO
2-71	E1 E2 E3	MA2511-F	64F2633JVC	29AL08090K9FA	0	0	NO	NO	0	NO	NO
2-72	E3 E4	MA2511-F	64F2633JVC	29AL08090K9FA	0	NO	NO	NO	0	NO	10K

X57-605X-XX (P/F)	CR71
0-00	J42
0-01	J1 J3
0-11	K1 K3
0-12	K2
2-71	E1 E2 E3
2-72	E2 E4

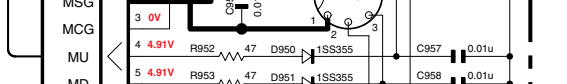
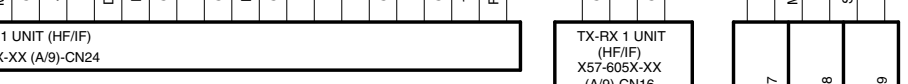
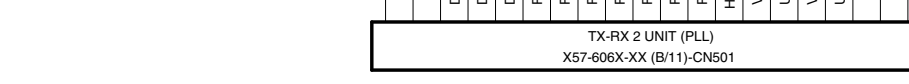
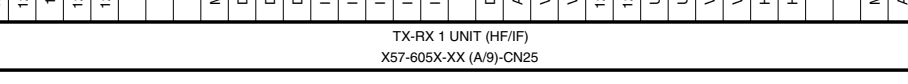
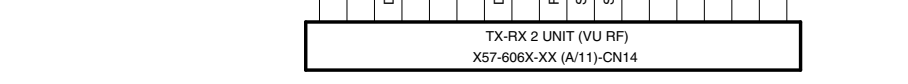
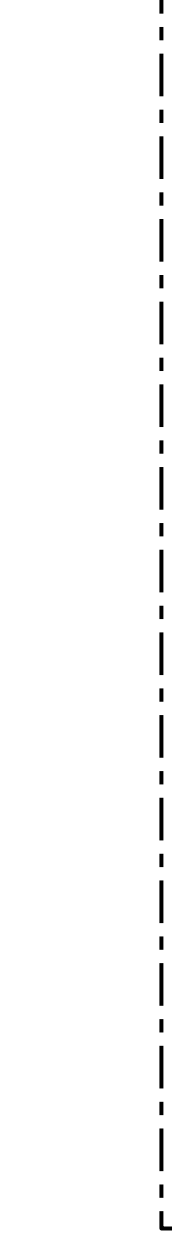
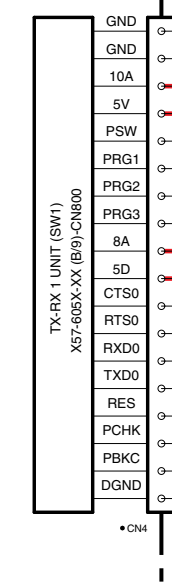
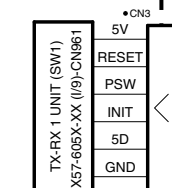

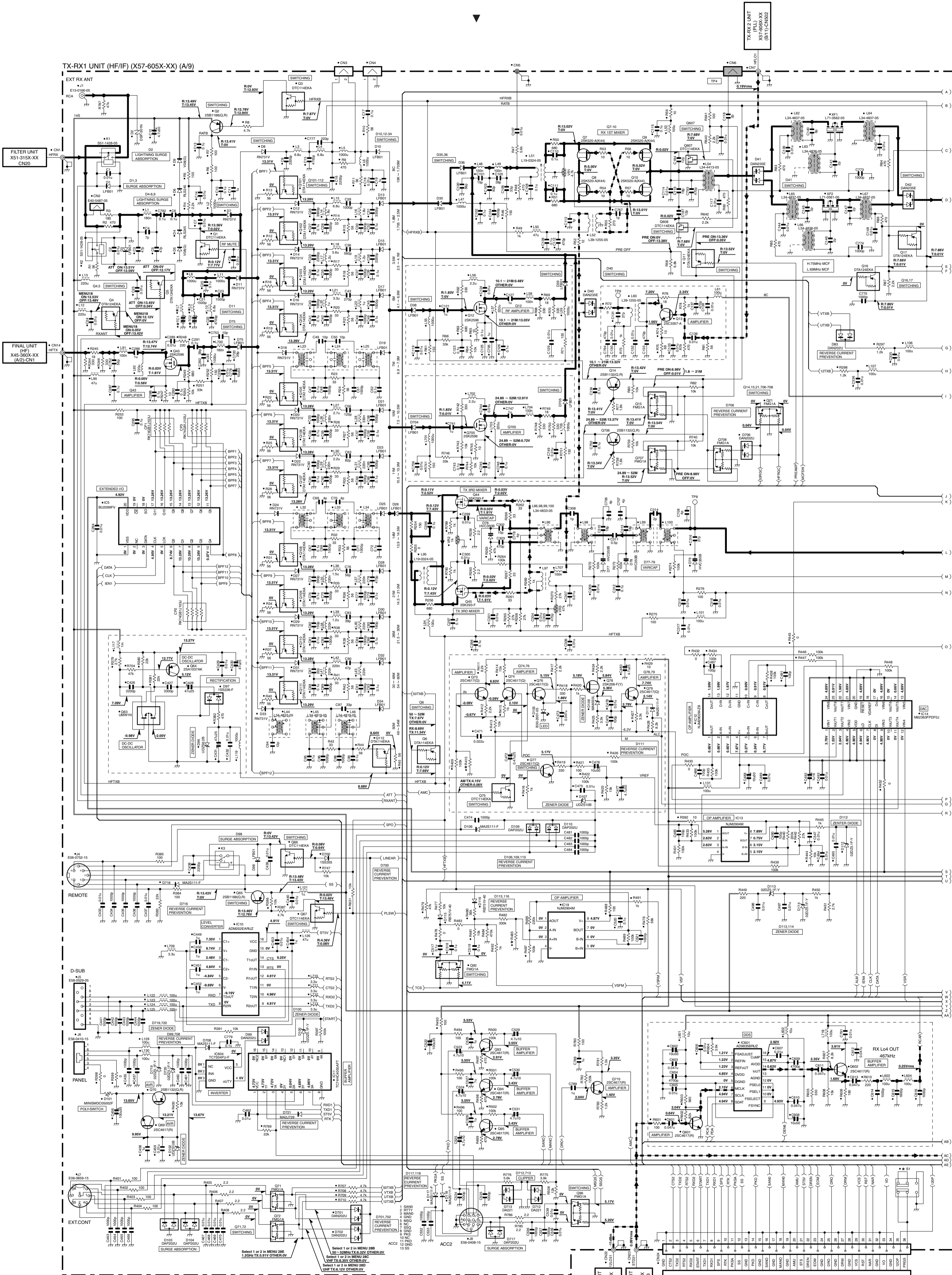

X57-605X-XX	S1	TC1	TC2	L7	L8	R410	R485
0-00	J1, J2	NO	NO	NO	NO	330k	120k
0-01	J1, J3	NO	NO	NO	NO	NO	390k
0-11	K1, K3	S82-0412-05	NO	NO	NO	NO	330k
0-12	K2	S82-0412-05	NO	NO	NO	NO	330k
2-71	E1, E3, E4	S82-0412-05	C05-0344-15	C05-0344-15	6.8u	6.8u	330k
2-72	E2, E4	S82-0412-05	C05-0344-15	C05-0344-15	6.8u	6.8u	330k

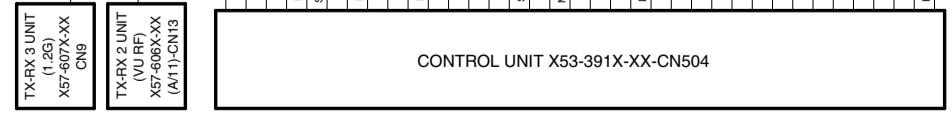

Note : Components marked with a dot (•) are parts of layer 1.

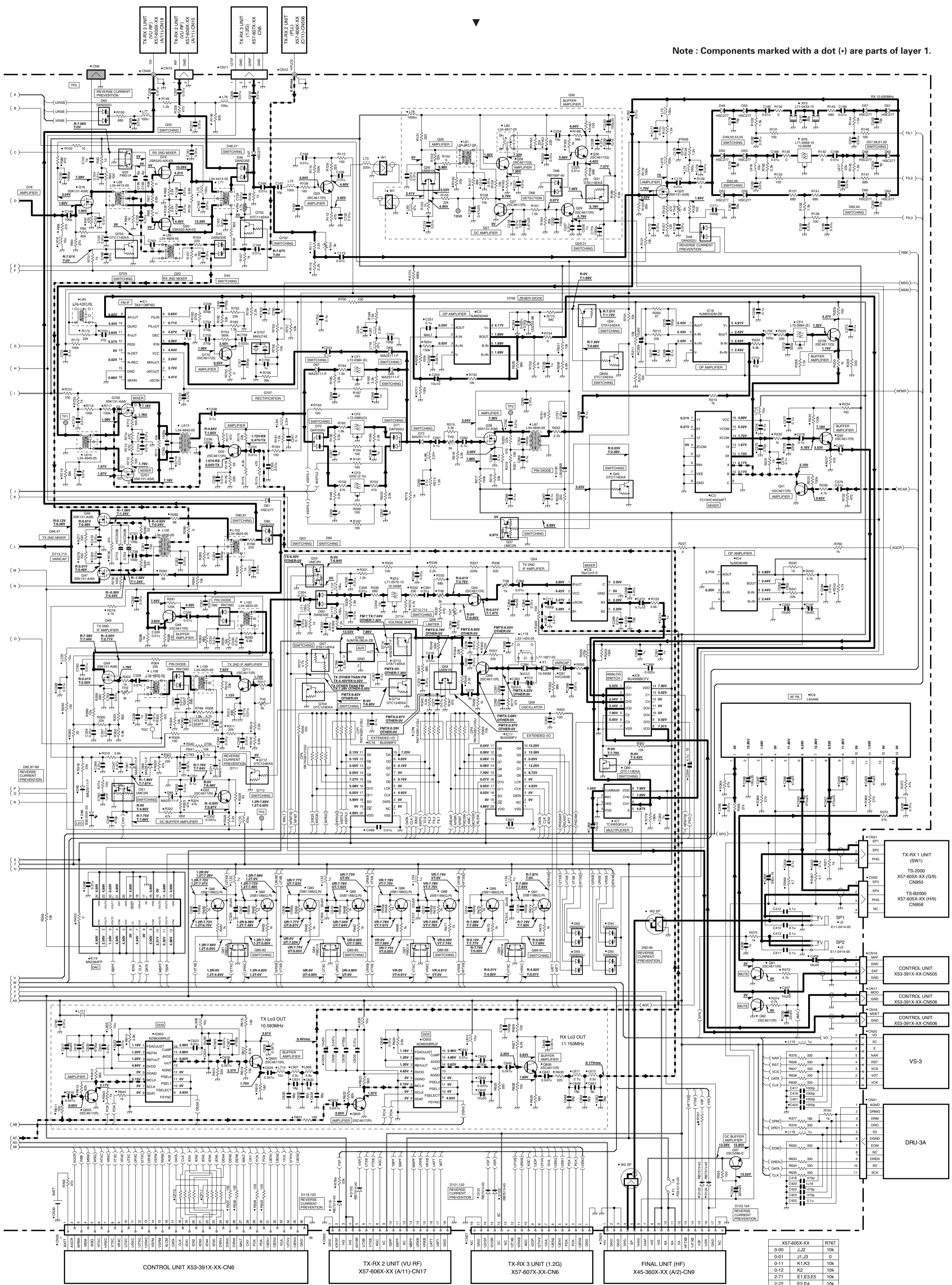

X57-605X-XX	R767
0-00	JJ2 10k
0-01	J1,J3 0
0-11	K1,K3 10k
0-12	K2 10k
2-71	E1,E3,E5 10k
2-72	E2,E4 10k

TX-RX1 UNIT (HF/F) (X57-605X-XX) (A/9)

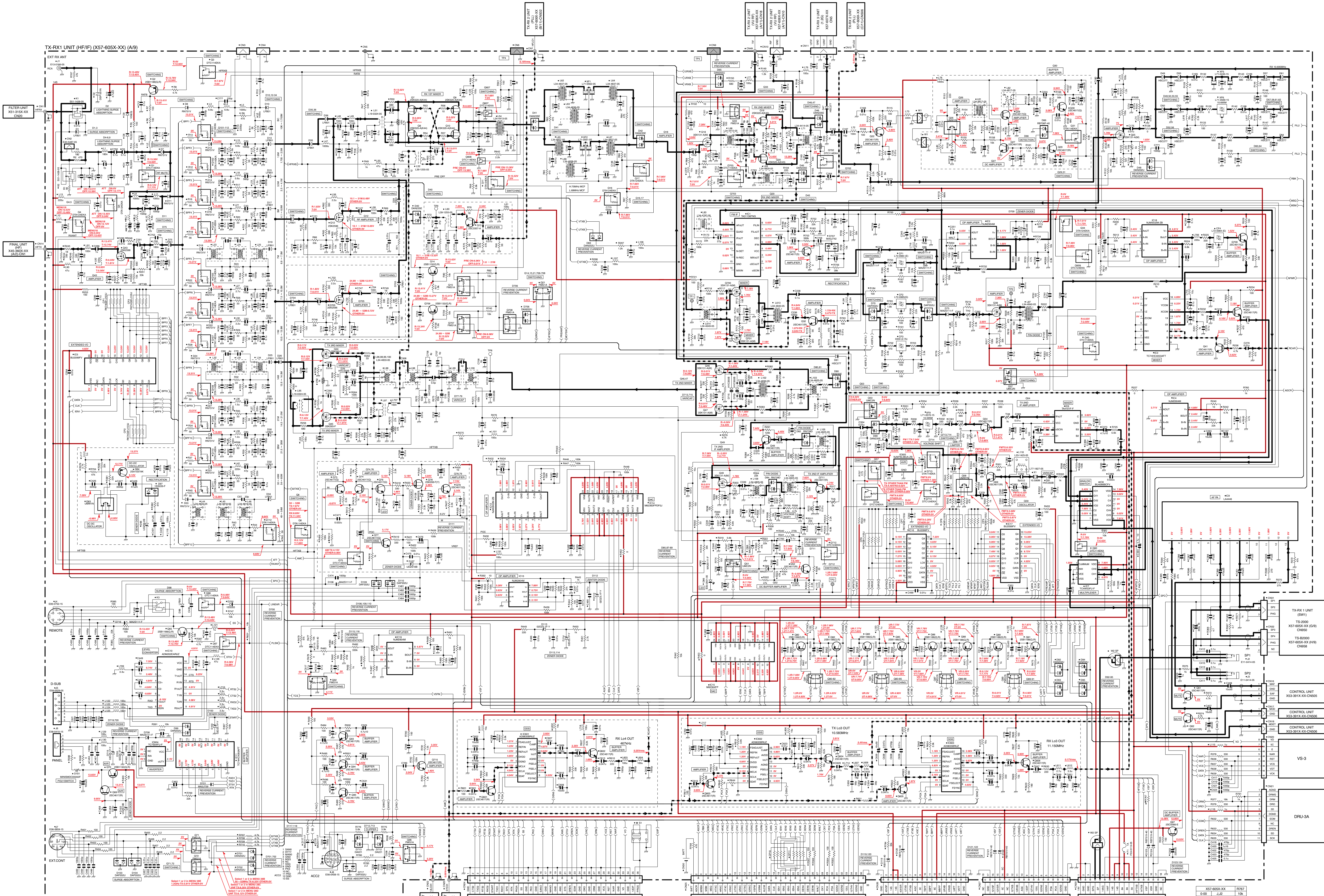

X57-605X-XX	S1	TC1	TC2	L7	L9	R410	R465
0-00	J12	NO	NO	NO	NO	NO	30K 10%
0-01	J13	NO	NO	NO	NO	NO	NO 39K
0-11	K1 A2	560-0412-05	NO	NO	NO	NO	30K 10%
0-12	K2	560-0412-05	NO	NO	NO	NO	30K 10%
2-71	E13.E5	560-0413-05	C00-0444-15	C00-0444-15	6.8u	6.8u	30K 10%
2-72	E2.E4	560-0413-05	C00-0444-15	C00-0444-15	6.8u	6.8u	30K 10%

X57-605X-XX	R37
0-00	J12
0-01	J13
0-11	K1A2
0-12	K2
2-71	E13.E5
2-72	E2.E4

CONTROL UNIT X53-391X-XX-CN54

CONTROL UNIT X53-391X-XX-CN6

TX-RX 2 UNIT (VU RF)
X57-606X-XX (A11)-CN17

TX-RX 3 UNIT (VU RF)
X57-607X-XX-CN9

FINAL UNIT (HF)
X45-360X-XX (A2)-CN9

TX-RX 1 UNIT (HF/F)
TS-2000
X57-605X-XX (S/9)
CN50

CONTROL UNIT
X53-391X-XX-CN55

CONTROL UNIT
X53-391X-XX-CN56

CONTROL UNIT
X53-391X-XX-CN56

VS-3

DRU-3A

TX-RX 1 UNIT (SW1) (X57-605X-XX) (B/9)

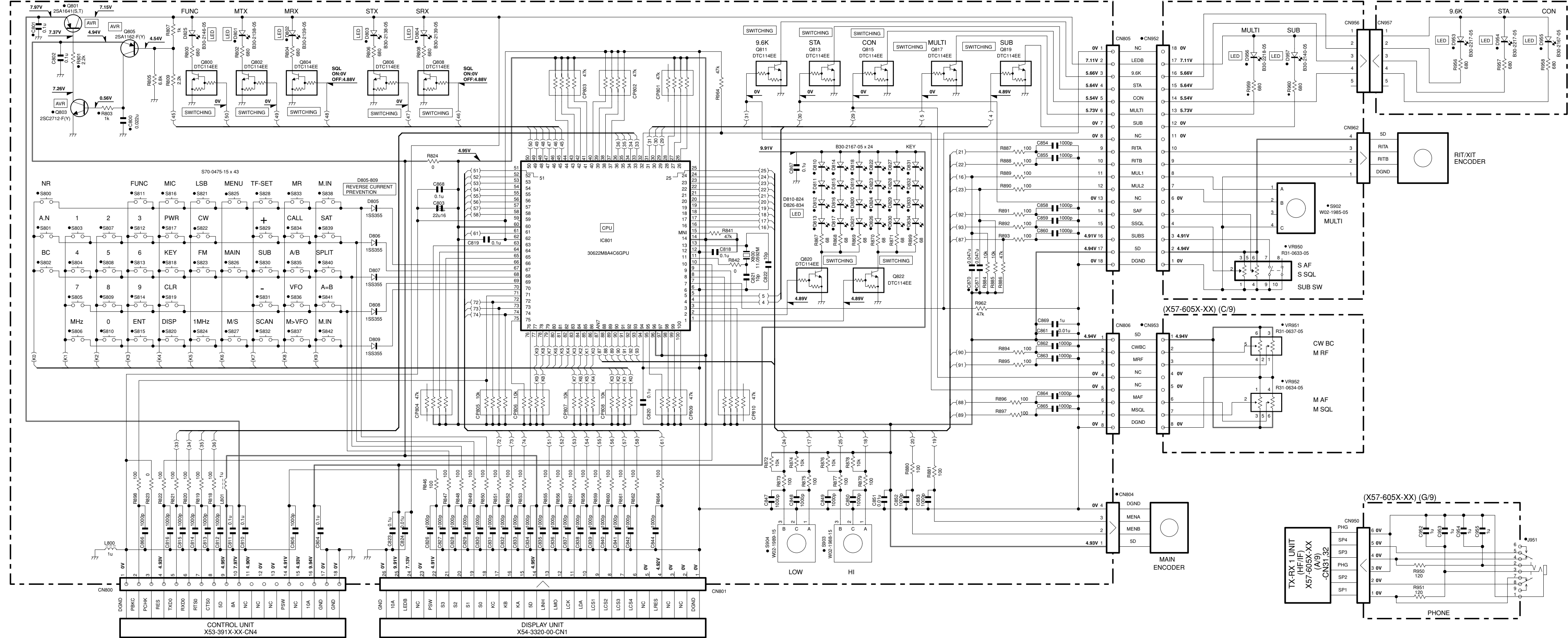

SCHEMATIC DIAGRAM TS-2000/B2000/2000X TS-2000S/2000V/2000SX/2000VX

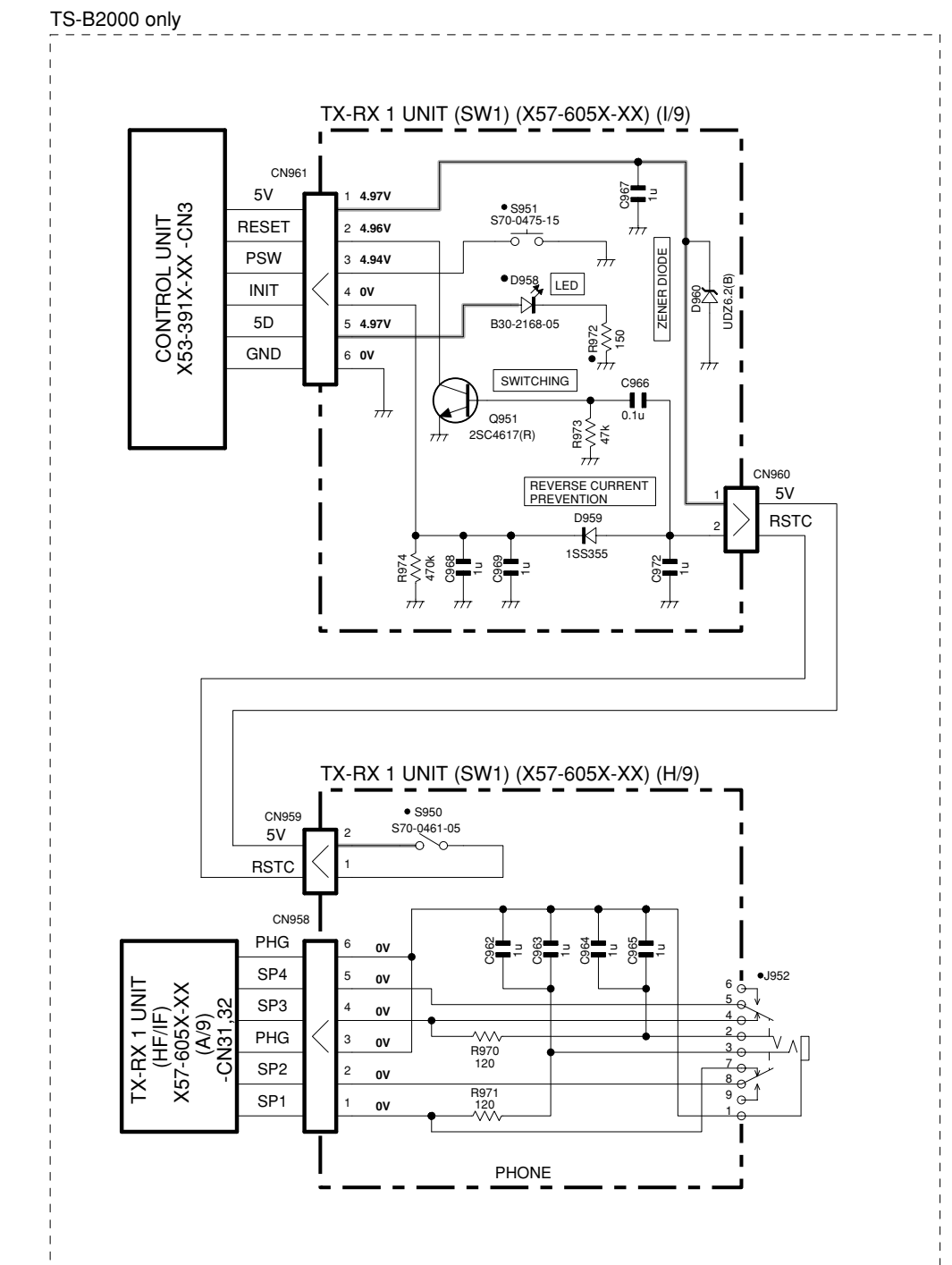

Note : The components marked with a dot (•) are parts of layer 1.

TX-RX 1 UNIT (SW1) (X57-605X-XX) (B/9)

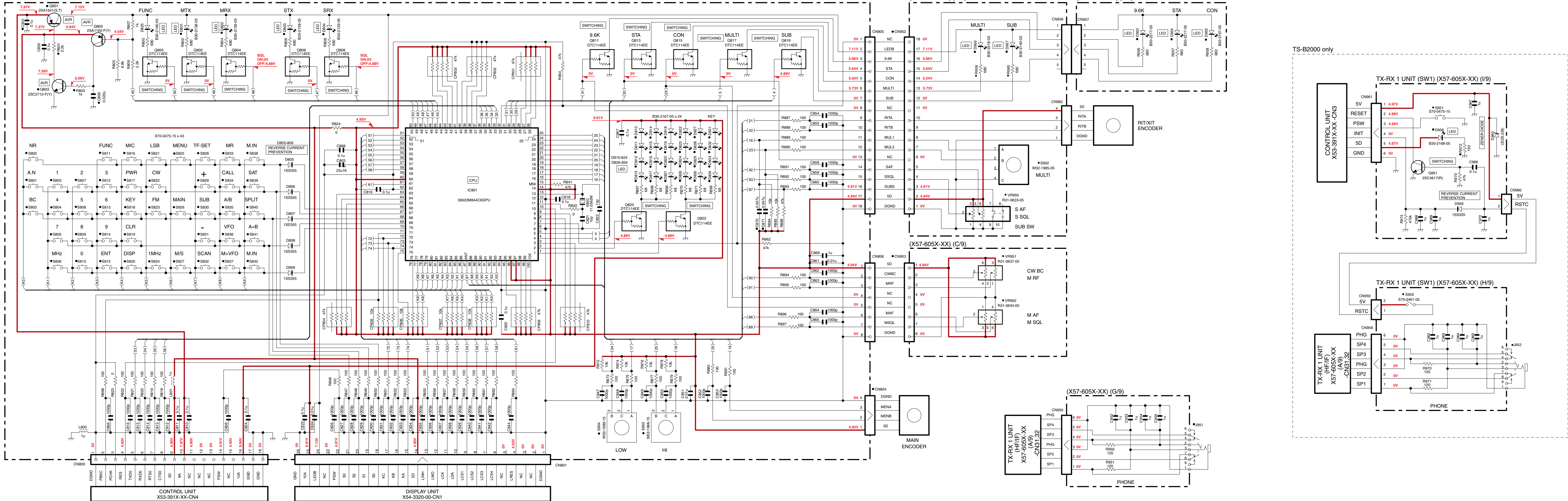

TS-B2000 only

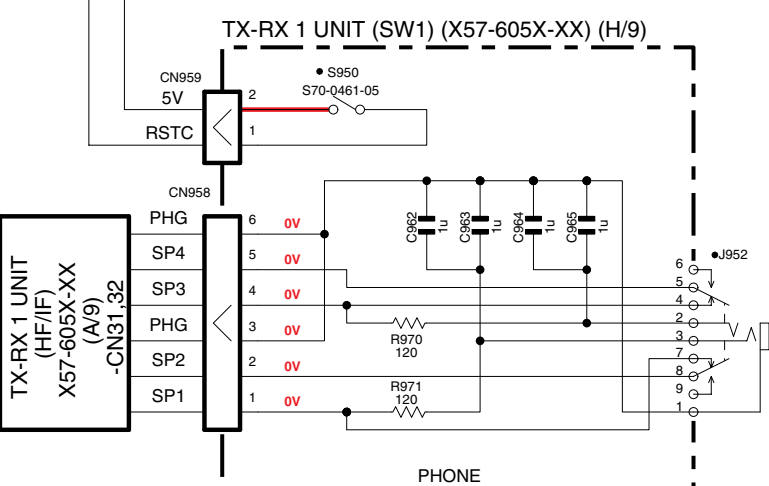
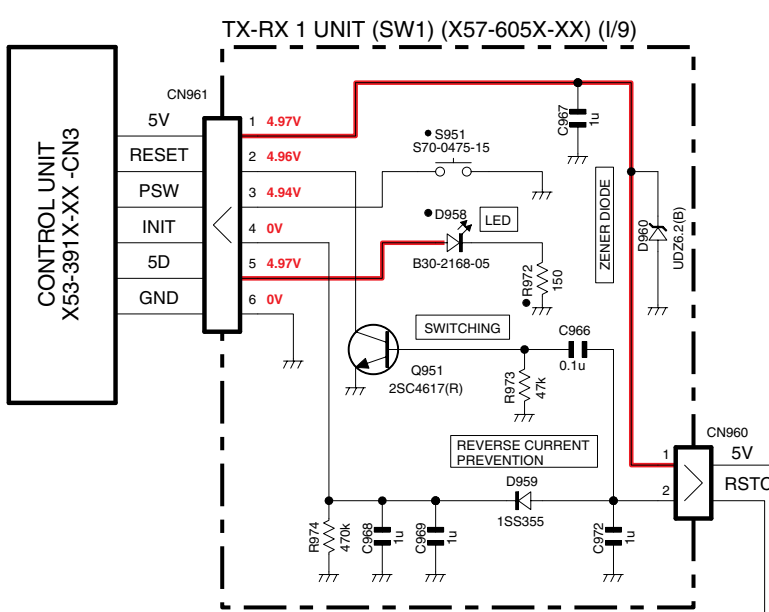

TS-2000/B2000/2000X
TS-2000S/2000V/2000SX/2000VX **SCHEMATIC DIAGRAM**

Note: The components marked with a dot (•) are parts of layer 1.

TX-RX 2 UNIT (VU RF) (X57-606X-XX) (A11)

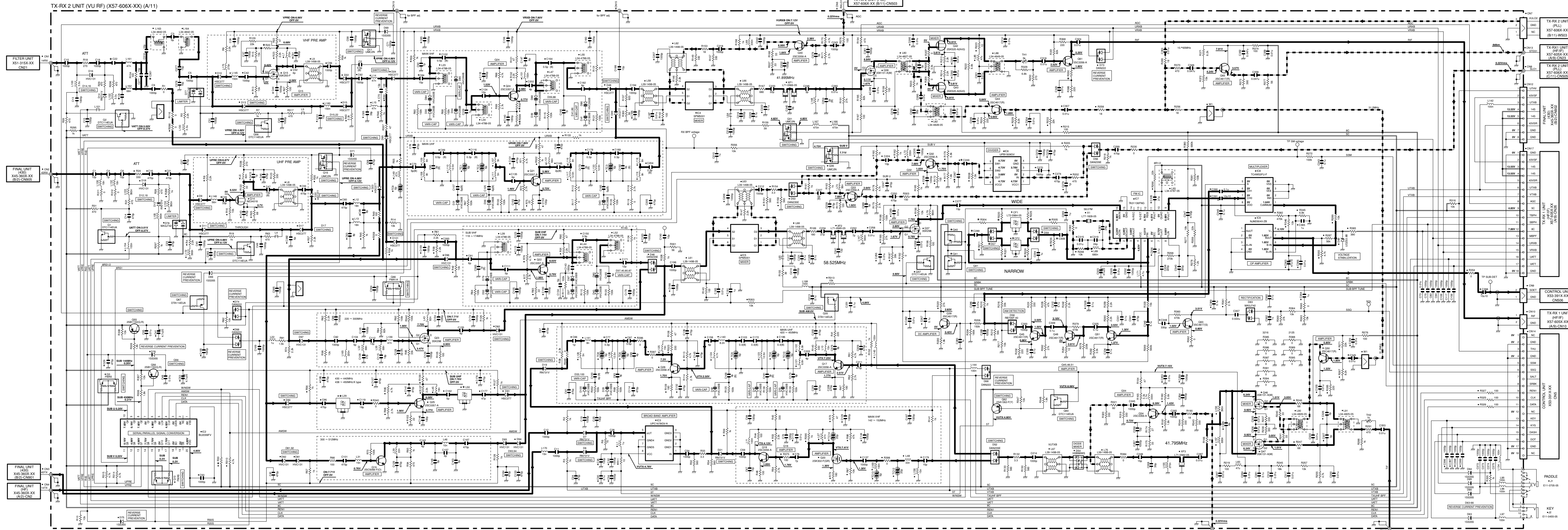

X57-606X-XX	CF2	D57	D59	Q40	Q41	L29	L50	R20	R30	R97	R211	R220	R221	R225	R226	R236	R304	R305	R350	R399	C8	C22	C249	C289	C308	C361	C387
0-90	J1, J2, J3	NO	NO	NO	NO	L79-1868-05	L79-1868-05	5.6k	NO	12	NO	NO	NO	NO	NO	NO	0	0	10	10	12p	1000p	5p	NO	NO	18p	47p
0-11	K3, K2, K1	NO	NO	NO	NO	L79-1868-05	L79-1868-05	22k	NO	15	NO	NO	NO	NO	NO	NO	0	0	6.8k	22k	18p	10p	NO	NO	27p	18p	
2-71	E1, E2, E3, E4, E5	DAN235E	DAN235E	DAN235E	DAN235E	L79-1868-05	L79-1868-05	5.6k	4.7k	12	15k	22k	22k	22k	22k	15k	NO	NO	NO	100	12p	1000p	5p	0.1u	0.1u	18p	47p

TX-RX 2 UNIT (PL1) (X57-606X-XX) (B11)-CN503

TX-RX 1 UNIT (HF1F) (X57-606X-XX) (A9)-CN10

TX-RX 1 UNIT (HF1F) (X57-606X-XX) (A9)-CN10

TX-RX 1 UNIT (HF1F) (X57-606X-XX) (A9)-CN10

TX-RX 2 UNIT (VU RF) (X57-606X-XX) (A/11)

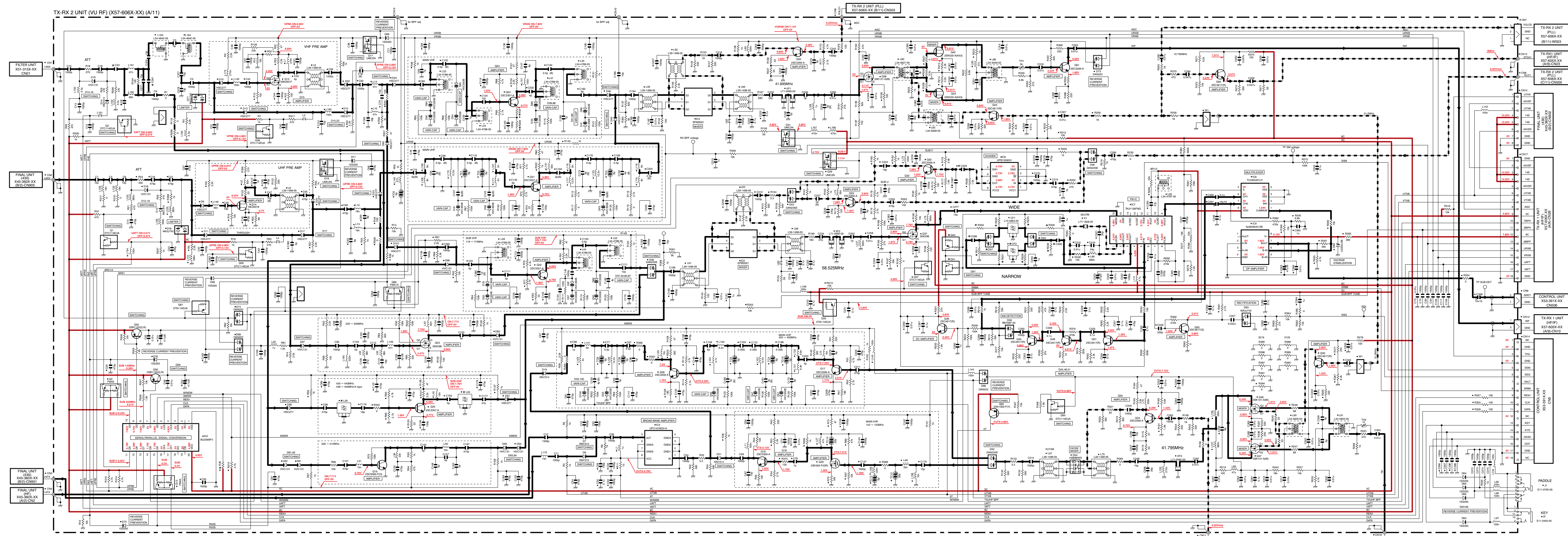

TX-RX 2 UNIT (PLL) X57-606X-XX (B11)-CN503

TX-RX 1 UNIT (HFIF) X57-605X-XX (A9)-CN49

KEY #1 E11-0465-05

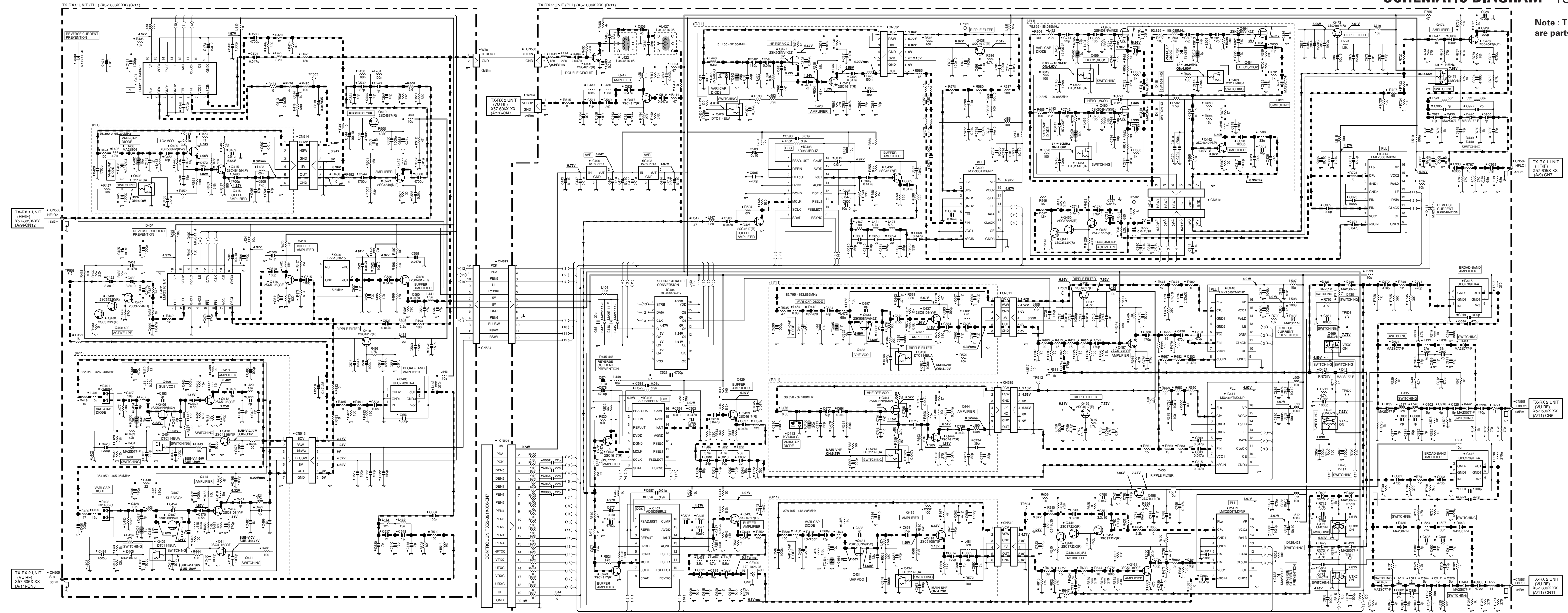

Note : The components marked with a dot (•) are parts of layer 1.

TX-RX 2 UNIT (PLL) (X57-606X-XX) (C11)

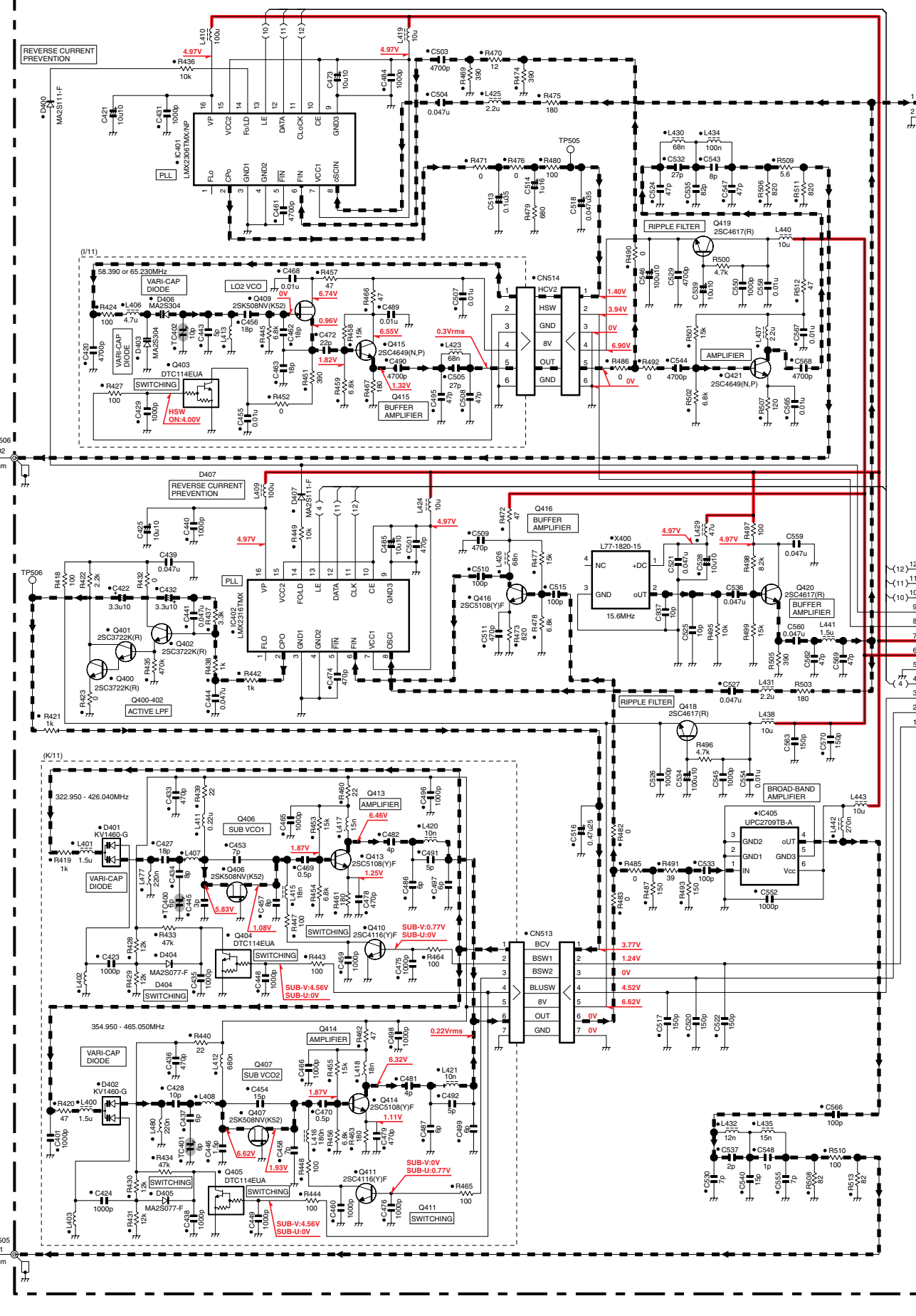

TX-RX 2 UNIT (PLL) (X57-606X-XX) (B11)

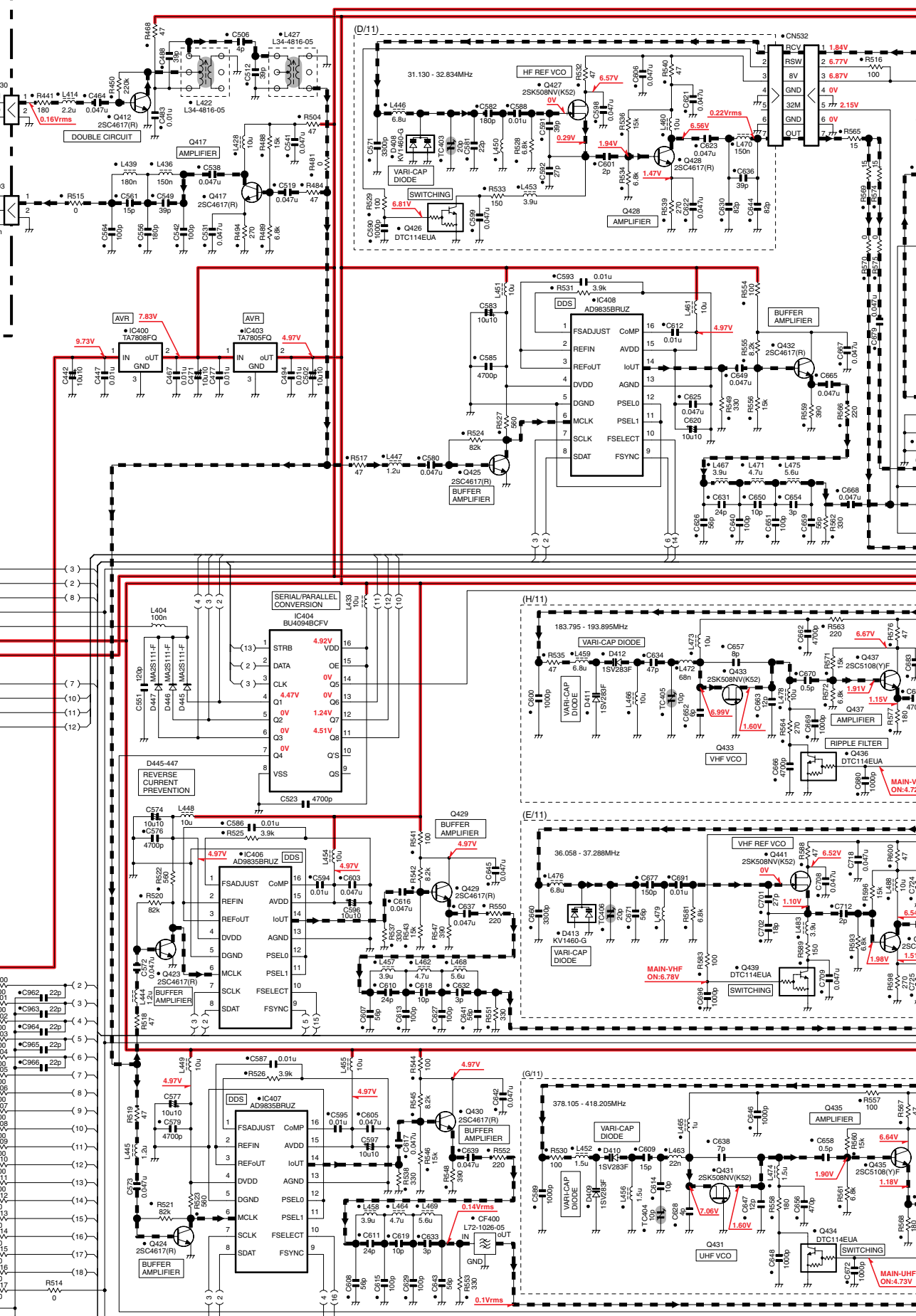

TX-RX 1 UNIT (HF/IF) (X57-606X-XX) (A91)-CN12

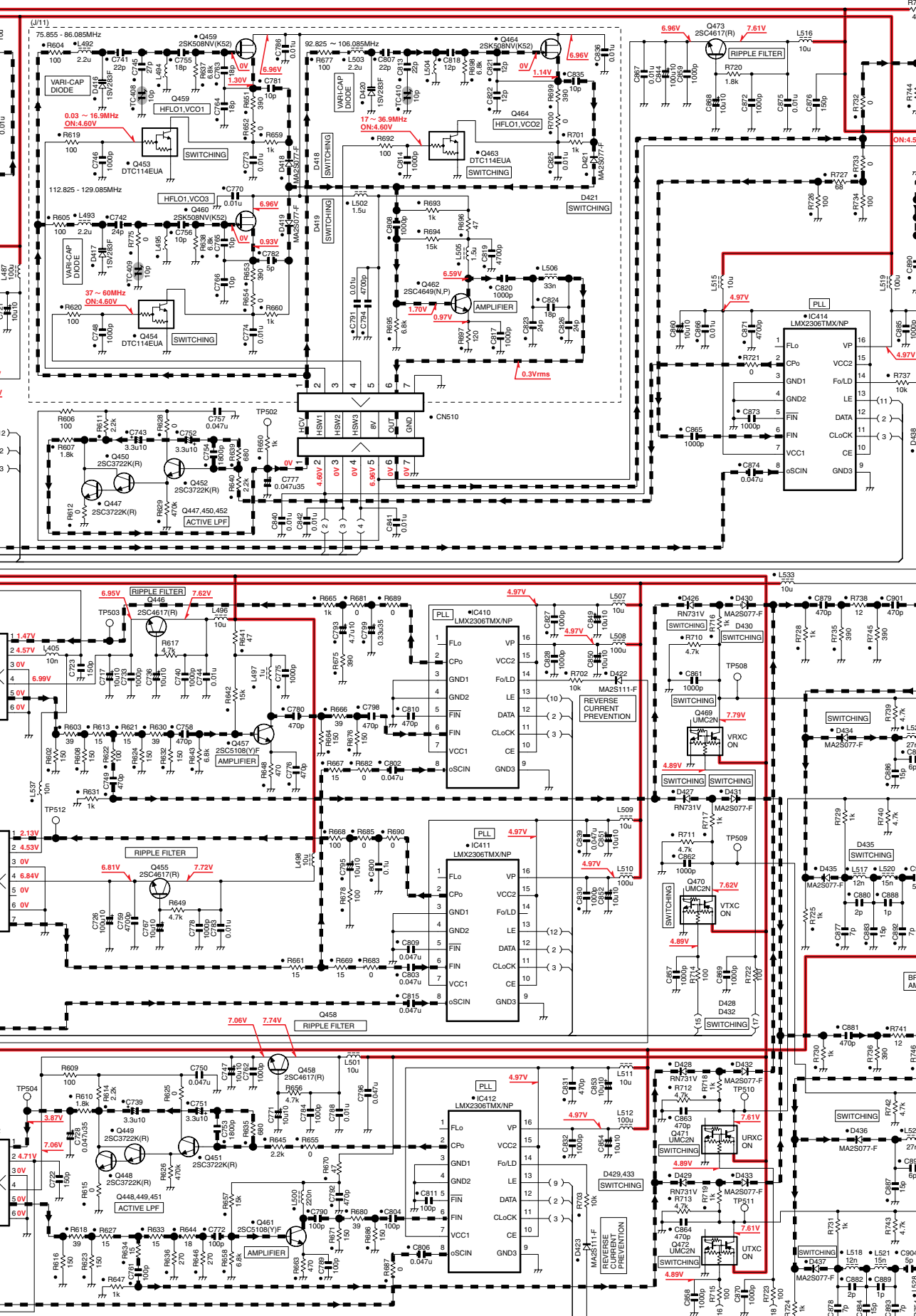

TX-RX 1 UNIT (VU RF) (X57-606X-XX) (A11)-CN6

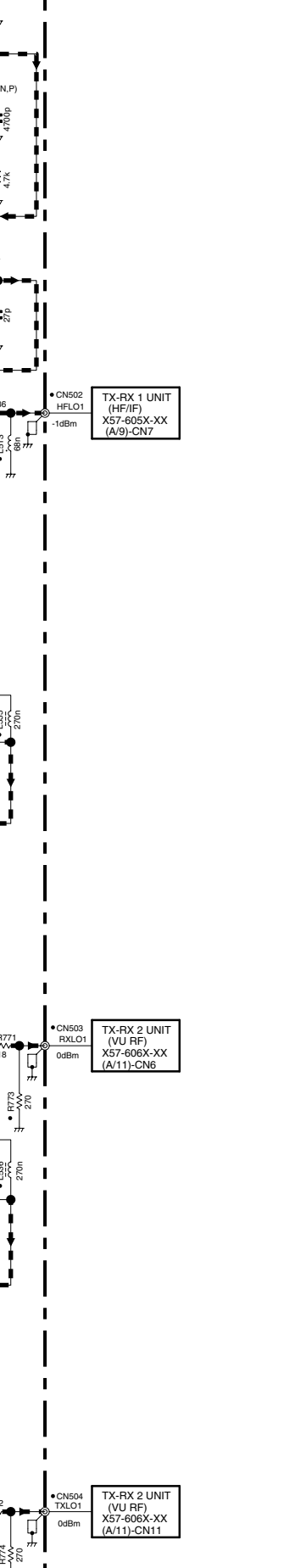

TX-RX 2 UNIT (VU RF) (X57-606X-XX) (A11)-CN6

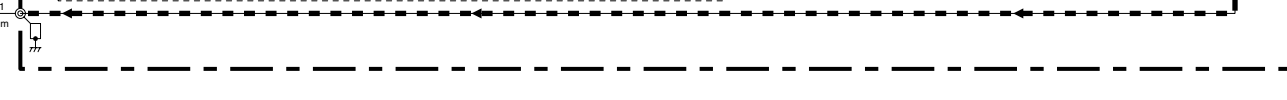

TX-RX 2 UNIT (VU RF) (X57-606X-XX) (A11)-CN6

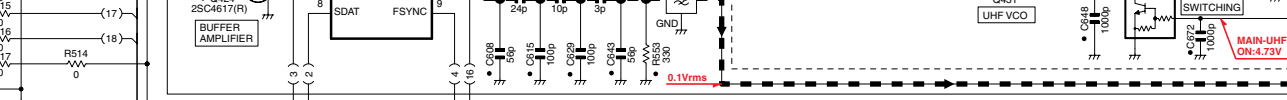

TX-RX 1 UNIT (VU RF) (X57-606X-XX) (A11)-CN6



TX-RX 2 UNIT (VU RF) (X57-606X-XX) (A11)-CN6

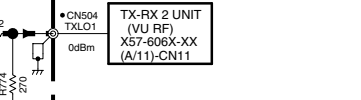

TS-2000/B2000/2000X
 TS-2000S/2000V/2000SX/2000VX **SCHEMATIC DIAGRAM**

Note : The components marked with a dot (•) are parts of layer 1.

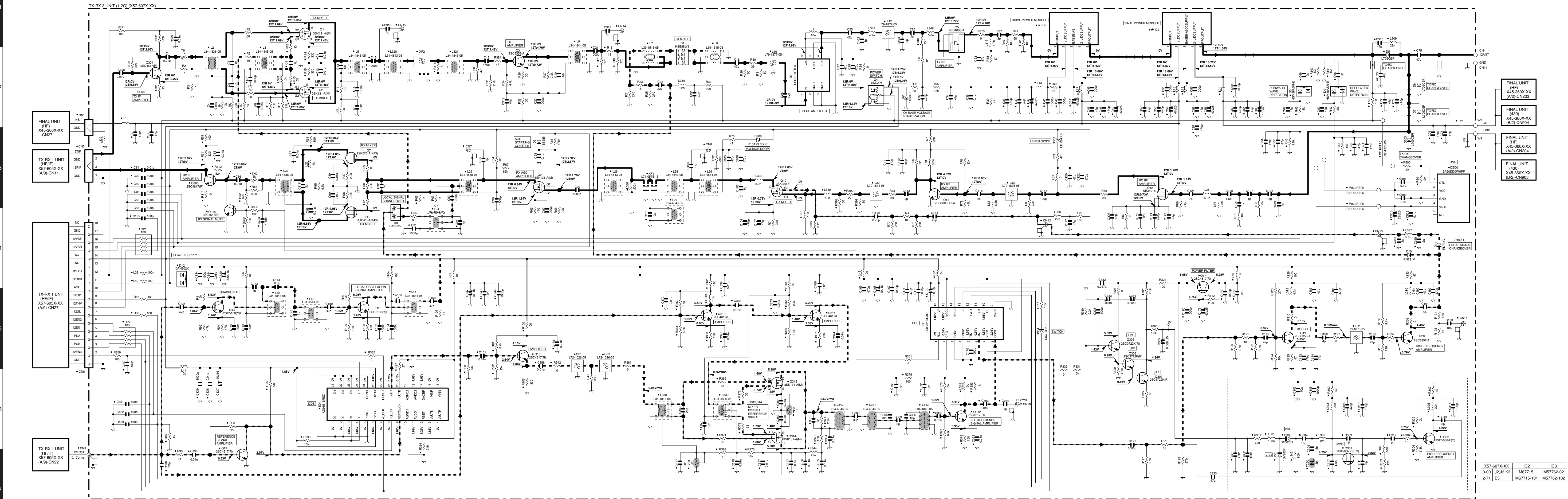

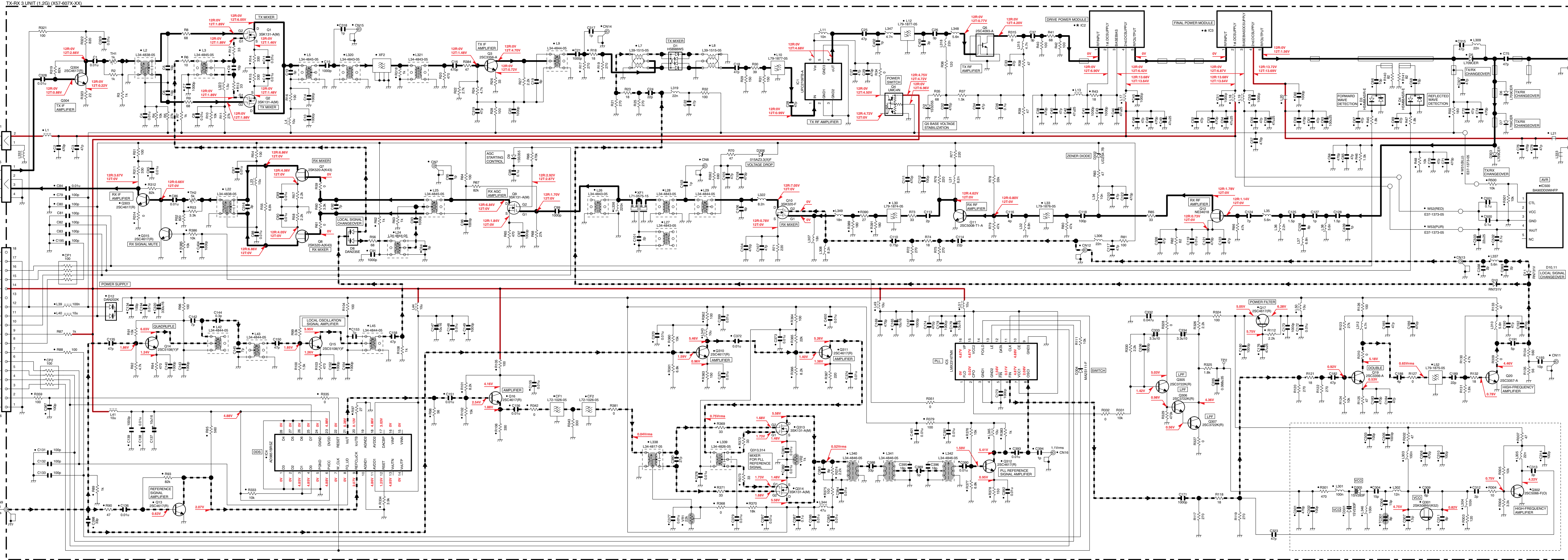

- FINAL UNIT (HF) X45-360X-XX (A/2)-CN203
- FINAL UNIT (430) X45-360X-XX (B/2)-CN804
- FINAL UNIT (HF) X45-360X-XX (A/2)-CN204
- FINAL UNIT (430) X45-360X-XX (B/2)-CN803

X57-607X-XX	IC2	IC3
0-00 J2,J3,K3	M67715	M57762-02
2-71 E5	M67715-101	M57762-102

TS-2000/B2000/2000X
TS-2000S/2000V/2000SX/2000VX

Kenwood Corporation

2967-3, Ishikawa-machi, Hachioji-shi, Tokyo, 192-8525 Japan

Kenwood U.S.A. Corporation

P.O. BOX 22745, 2201 East Dominguez Street, Long Beach,
CA 90801-5745, U.S.A.

Kenwood Electronics Canada Inc.

6070 Kestrel Road, Mississauga, Ontario, Canada L5T 1S8

Kenwood Electronics Deutschland GmbH

Rembrücker Str. 15, 63150 Heusenstamm, Germany

Kenwood Electronics Belgium N.V.

Leuvensesteenweg 248 J, 1800 Vilvoorde, Belgium

Kenwood Electronics France S.A.

L'Etoile Paris Nord 2, 50 Allée des Impressionnistes,
Bp 58416 Villepinte, 95944 Roissy Ch De Gaulle Cedex

Kenwood Electronics UK Limited

KENWOOD House, Dwight Road, Watford, Herts.,
WD18 9EB United Kingdom

Kenwood Electronics Europe B.V.

Amsterdamseweg 37, 1422 AC Uithoorn, The Netherlands

Kenwood Electronics Italia S.p.A.

Via G. Sirtori, 7/9 20129 Milano, Italy

Kenwood Ibérica, S.A.

Bolivia, 239-08020 Barcelona, Spain

Kenwood Electronics Australia Pty. Ltd.

(A.C.N. 001 499 074)

16 Giffnock Avenue, Centrecourt Estate, North Ryde, N.S.W. 2113 Australia

Kenwood Electronics (Hong Kong) Ltd.

Unit 3712-3724, Level 37, Tower one Metroplaza, 223 Hing Fong Road,
Kwai Fong, N.T., Hong Kong

Kenwood Electronics Singapore Pte Ltd

1 Ang Mo Kio Street 63, Singapore 569110

