

**HF  
TRANSCEIVER**

# **TS-830S/TS-830M**



The TS-830S is a high-performance, very affordable, HF SSB/CW transceiver with every conceivable operating feature built in for 160 through 10 meters. (including the three new bands) The TS-830S combines a high dynamic range with variable bandwidth tuning, IF shift, and an IF notch filter, as well as very sharp filters in the 455 kHz second IF. Its optional VFO-230 digital VFO provides five memories. The TS-830M includes built-in AM Mode.

#### 160-10 Meters, Including Three New Bands

The TS-830S and TS-830M cover all amateur frequencies between 1.8 and 29.7 MHz, including the new 10, 18, 24 MHz bands. It receives WWV on 10 MHz for confirming the calibration of the highly accurate digital display. Transmit and receive modes include LSB, USB, CW (TS-830S) and AM (TS-830M).

#### Wide Receiver Dynamic Range

The receiver section of the TS-830S and TS-830M has a very wide dynamic range with impressive IMD rejection characteristics, resulting in increased immunity to strong, local signals. Its 3SK73 MOS FET RF amplifier operates at a low level of amplification, for improved IMD characteristics. A higher level of amplification is not required because of the balanced mixer's low noise figure, produced by 2SK125 junction FETs. A dual resonator is provided for each band. The result is a very sensitive receiver section with excellent dynamic range and a low noise level.

#### VBT - Variable Bandwidth Tuning

With the inclusion of the VBT (variable bandwidth tuning) circuit capable of continuously varying the IF filter passband width, optimum IF bandwidth may be established relative to varying conditions of interference.

IF passband shift and VBT are independently adjustable. Therefore, it is possible to change the IF passband width whilst the center frequency of the IF passband remains unchanged, or, whilst maintaining the passband width established by VBT, shift the passband (center frequency) of the filter to an optimum point with the IF shift.

Combined application with an IF notch may also be used.

#### How VBT (variable bandwidth tuning) works

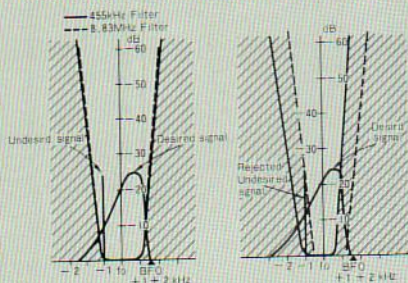

- Passbands of both the 8.83 MHz and 455 kHz IF filters are made to intersect, in an equivalent sense, to obtain a narrow-bandwidth filter response. See how the unwanted signal is rejected from the passband thus obtained.
- In cases where interference from adjacent signals isn't too serious, signal-to-noise ratio may be improved by narrowing proportionally the IF passband width, as the noise content theoretically varies with bandwidth.
- The variable bandwidth tuning (VBT) filter circuit in the TS-830S and TS-830M is so designed that the center frequency of the passband may be set to the desired point (by adjusting or by an IF shift), irrespective of the amount of bandwidth changed.

#### IF Notch Filter

The tunable notch filter in the TS-830S and TS-830M is a high-Q active circuit in the 455 kHz second IF. Sharp, deep notch characteristics will eliminate a strong interfering carrier within the passband of the receiver section.

#### How the IF notch works

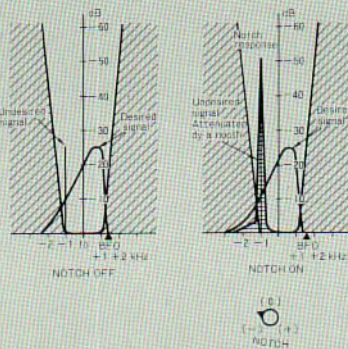

- The tunable notch filter in the TS-830S and TS-830M offers satisfactorily sharp notch response.

#### How an IF shift works

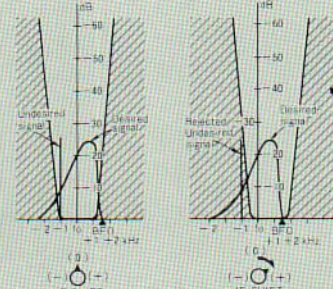

- Shown here is an undesired signal being rejected by upshifting (+) the IF passband. Elimination of undesired signals by an IF shift is simple in operation.
- In CW, coupled with RIT, a variable pitch is obtainable; in SSB, the signal may be tuned to suit your requirement.

#### Combined activation of IF shift and VBT

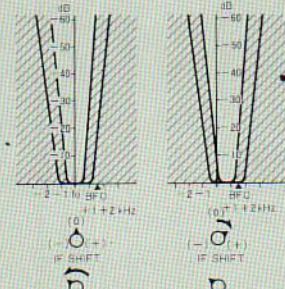

- Since the variable bandwidth tuning (VBT) filter and IF shift are separately adjustable in the TS-830S and TS-830M highly sophisticated unwanted signal rejection technique may be employed: first an appropriated bandwidth is selected by the variable bandwidth tuning and then an optimum tuning point is determined by means of an IF shift. It is particularly effective in CW and RTTY when, by narrowing passband width by means of the VBT, the center frequency of the passband is aligned to the frequency of the desired signal by an IF shift.
- It is of course possible to fix the center frequency of the passband established by IF shifting and, according to the interference condition at the moment, the passband width can be adjusted by means of the VBT.

#### IF Shift

The variable bandwidth tuning (VBT) and notch circuits, when combined with the IF shift, provide higher adjacent channel selectivity, very useful under crowded conditions. The IF shift circuit is capable of shifting the IF passband toward higher (+) or lower (-) frequencies with the tuned receiver frequency totally unchanged. Hence, an unwanted signal, if present in the IF passband, may be attenuated signi-

## SM-220 Station Monitor



Based on a wide-frequency-range oscilloscope (up to 10 MHz), the SM-220 station monitor features, in combination with a built-in two-tone generator, a wide variety of waveform-observing capabilities. An optional feature is a unique pan-display capability. The SM-220 provides efficient station operation as it monitors transmitted waveforms, and it also serves as a high-sensitivity, wide-frequency range oscilloscope for various adjustments and experiments.

### SPECIFICATIONS

(Transmit Signal Monitor Terminal) • Frequency Range: 1.8–150 MHz • Maximum Power: 1 kW (1.8–54 MHz), 50W (150 MHz) • SWR: 1.2:1 or less • Deflection Sensitivity: More than 1 div. at 2W input • Attenuator: 6 steps (Trapezoid Waveform Observation) • Frequency Range: 1.8–30 MHz • Maximum Power at DRIVE TERMINAL: 2–100W • SWR: 1.2:1 or less (Two-Tone Generator) • Oscillator Frequency: 1,000 Hz and 1,575 Hz • Output Voltage: 10 mV/50 k $\Omega$  (at TWO TONE) (Pan Display Unit) • Input Center Frequency: 3,395 MHz (BS-5), 8,830 MHz (BS-8) • IF Frequency: 455 kHz • IF Bandwidth: More than 1 kHz (–6 dB) • Input Sensitivity: More than 10  $\mu$ V/div. • Scan Width:  $\pm$ 20 kHz,  $\pm$ 100 kHz • IF switchable gain (Horizontal Amplifier) • Deflection Sensitivity: More than 300 mV/div. • Frequency Response: DC–250 kHz or over (EXT GAIN at MAX) DC–40 kHz (EXT GAIN at 1/2) • Input Resistance/Capacitance: 1 M $\Omega$  ( $\pm$ 20%/35 PF or less (SYNC switch at INT)) • Attenuator: Fully Variable to 0 • Max. Input Voltage: 100 Vp-p (Sweep Circuit) • Sweep Frequency: 10 Hz–100 kHz (4 ranges, with fine adjustment) • Sweep Linearity: More than 5% • Sync System: Synchronized sweep, internal negative sync and external sync • Sync Amplitude: Internal: More than 1 div. on CRT External: More than 2 Vp-p (Vertical Amplifier) • Deflection Sensitivity: More than 20 mV/div. • Frequency Response: 2 Hz–10 MHz (–3 dB) • Input Resistance/Capacitance: 1 M $\Omega$ /40 PF • Overshoot: Less than 5% • Attenuator: 1, 1/10, 1/100 and GND/MONITOR (Error between steps: 5% max.) • Max. Input Voltage: 300V (DC-AC peak) or 600 Vp-p • Power Supply: 120/220/240V AC  $\pm$ 10%, 50/60 Hz 20W • Dimensions: 215 (8.6)W x 153 (6.1)H x 335 (13.4)D mm (inch) • Weight: 5 kg (11 lbs)

### OPTIONAL ACCESSORIES

• BS-8 ••• Pan Display for TS-830S/TS-180S/TS-820 series • BS-5 ••• Pan Display for TS-520S/TS-520SE

### PC-1

Phone Patch (available only where phone patch operation is legal)



### HS-5

Deluxe Headphones (8 $\Omega$ )



### HS-4

Headphones (8 $\Omega$ )



### HC-10 Digital World Clock

This clock incorporating a precise quartz and digital display system as well as a built-in microcomputer can also recall and display the starting time of QSO for logging purpose. Power Requirements: 120/220/240V AC



### MC-30S (500 $\Omega$ )

MC-35S (50k $\Omega$ )  
Noise-Cancelling Hand Microphone



### MC-50 50 k $\Omega$ /500 $\Omega$ Desk Microphone



### DS-2 DC-DC Converter

#### SPECIFICATIONS

• Semiconductors: 2N4280 • Power consumption: 15A • Power supply: DC 12.0–16.0V • Dimensions: 80 (3.2)W x 39 (1.6)H x 69 (2.8) D mm (inch) • Weight: 240g (0.5 lbs)



(The CW filters are only for TS-830S)

### YG-455C

500 Hz CW filter for 455 kHz IF

### YG-455CN

250 Hz CW filter for 455 kHz IF

### YK-88C

500 Hz CW filter for 8.83 MHz IF

### YK-88CN

270 Hz CW filter for 8.83 MHz IF



## TS-830S/TS-830M SPECIFICATIONS

### [GENERAL]

Frequency range: 160m band 1.8 – 2.0 MHz  
80m band 3.5 – 4.0 MHz  
40m band 7.0 – 7.3 MHz  
\*30m band 10.1 – 10.15 MHz (10.0 MHz WWV)  
20m band 14.0 – 14.35 MHz  
\*17m band 18.068 – 18.168 MHz  
15m band 21.0 – 21.45 MHz  
\*12m band 24.89 – 24.99 MHz  
10m band 28.0 – 29.7 MHz

\* Receiving only. (Transmission on these bands is possible with a small modification.)

|        |         |                                    |
|--------|---------|------------------------------------|
| Modes: | TS-830S | SSB [USB, LSB] (A3J)/CW(A1)        |
|        | TS-830M | SSB [USB, LSB] (A3J)/CW(A1)/AM(A3) |

Audio Freq. Response: 400 to 2,600 Hz, within –6 dB  
RF output impedance: 50 $\Omega$  – 75 $\Omega$   
Power requirement: 120/220/240V AC 50/60 Hz  
Power consumption: TX = 295W  
RX = 32W (with heater OFF)  
Dimensions: 333(13.3) x 133(5.3) x 333(13.3) mm (inch)  
Weight: 13.3 kg (29.8 lbs)

### [TRANSMITTER]

Final power input:

|         |   |
|---------|---|
| TS-830S | 220W PEP for SSB operation<br>180W DC for CW operation                            |
| TS-830M | 220W PEP for SSB operation<br>180W DC for CW operation<br>80W DC for AM operation |

Audio input Impedance: 500 $\Omega$  – 50k $\Omega$   
RF Output Impedance: 50 $\Omega$  – 75 $\Omega$   
Frequency Stability: Within 100 Hz during any 30 minute period after warmup. Within 1 kHz during the first hour after 1 minute of warmup.  
Carrier suppression: Better than 40 dB

Sideband suppression: Better than 60 dB  
Spurious radiation: Better than 60 dB  
Harmonic Radiation: Better than 40 dB  
Variable Bandwidth:

|         |   |
|---------|---|
| TS-830S | SSB = 500 Hz – 2.4 kHz (–6 dB) continuously variable<br>CW = 150 Hz – 500 Hz (–6 dB) continuously variable (With optional CW filter YK-88C and YG-455C added) |
| TS-830M | SSB, CW = 500 Hz – 2.4 kHz (–6 dB) continuously variable<br>AM = 4.5 kHz – 6 kHz (–6 dB) continuously variable  |

Notch-filter Attenuation: Better than 40 dB  
Audio Output Impedance: 8 – 16 $\Omega$   
Audio Output: 1.5W (8 $\Omega$ )

### [RECEIVER]

|         |               |   |
|---------|---------------|---|
| TS-830S | SSB, CW       | 0.25 $\mu$ V at 10 dB S + N/N                               |
| TS-830M | SSB, CW<br>AM | 0.25 $\mu$ V at 10 dB S + N/N<br>2 $\mu$ V at 10 dB S + N/N |

Image Ratio: Better than 60 dB  
IF Rejection: Better than 80 dB  
Selectivity:

|         |   |
|---------|---|
| TS-830S | SSB/CW WIDE: 2.4 kHz (–6 dB), 3.6 kHz (–60 dB)<br>CW NARROW: With YK-88C (option filter) 500 Hz (–6 dB), 1.5 kHz (–60 dB)<br>With YK-88CN (option filter) 270 Hz (–6 dB), 1.1 kHz (–60 dB)<br>With YG-455C (option filter) 500 Hz (–6 dB), 820 Hz (–60 dB)<br>With YG-455CN (option filter) 250 Hz (–6 dB), 500 Hz (–60 dB) |
| TS-830M | SSB/CW: 2.4 kHz (–6 dB), 3.6 kHz (–60 dB)<br>AM: 6 kHz (–6 dB), 11 kHz (–60 dB)   |

Note: The circuit and ratings may change without notice due to development in technology.

### Differences between TS-830S and TS-830M

- The TS-830M operates in USB, LSB, CW and AM modes whilst the TS-830S has USB, LSB, CW(W) and CW(N) modes.
- Because the TS-830M has AM mode, the CW filters (YK-88C, YK-88CN, YG-455C, YG-455CN) cannot be fitted. However, the VBT system can be used to narrow the CW bandwidth from 2.4 kHz to 500 Hz.



TS-830M



TS-830S

Front-Panel (Mode-Switch) View

### Other Versatile Provisions

- Built-in 25 kHz Marker.
- Built-in AC power supply.
- Built-in VOX circuit for SSB operation and CW semi-break-in operation with sidetone.
- Switchable AGC circuit (SLOW/FAST/OFF).
- Built-in adjustable CW audio tone circuit.
- Built-in CW zero-beat function circuit.
- FIX channel switch.
- Multifunction meter (ALC/IP/RF/COMP/HV).
- LED indicators (RIT, XIT, RF ATT, VFO, FIX, and NOTCH).
- IF OUT-1 and IF OUT-2 terminals for SM-220 Station Monitor.

### Receiver Sensitivity

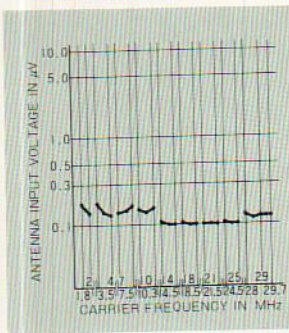

### Sensitivity/suppression characteristics

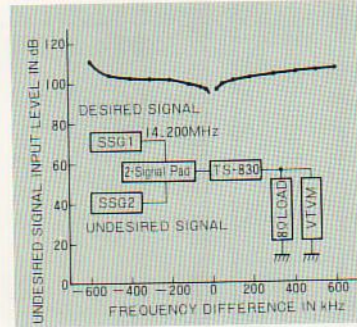

### Output Power (CW)

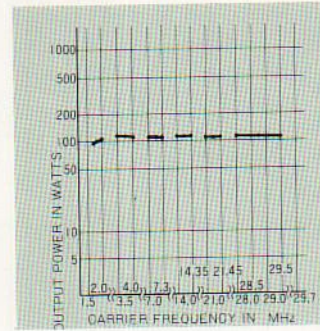

### IMD Characteristics

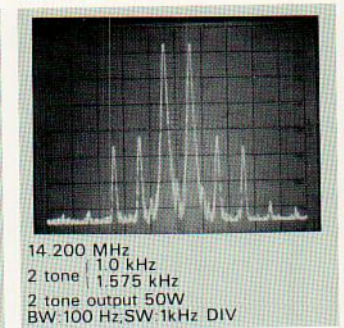

## TS-830S BLOCK DIAGRAM

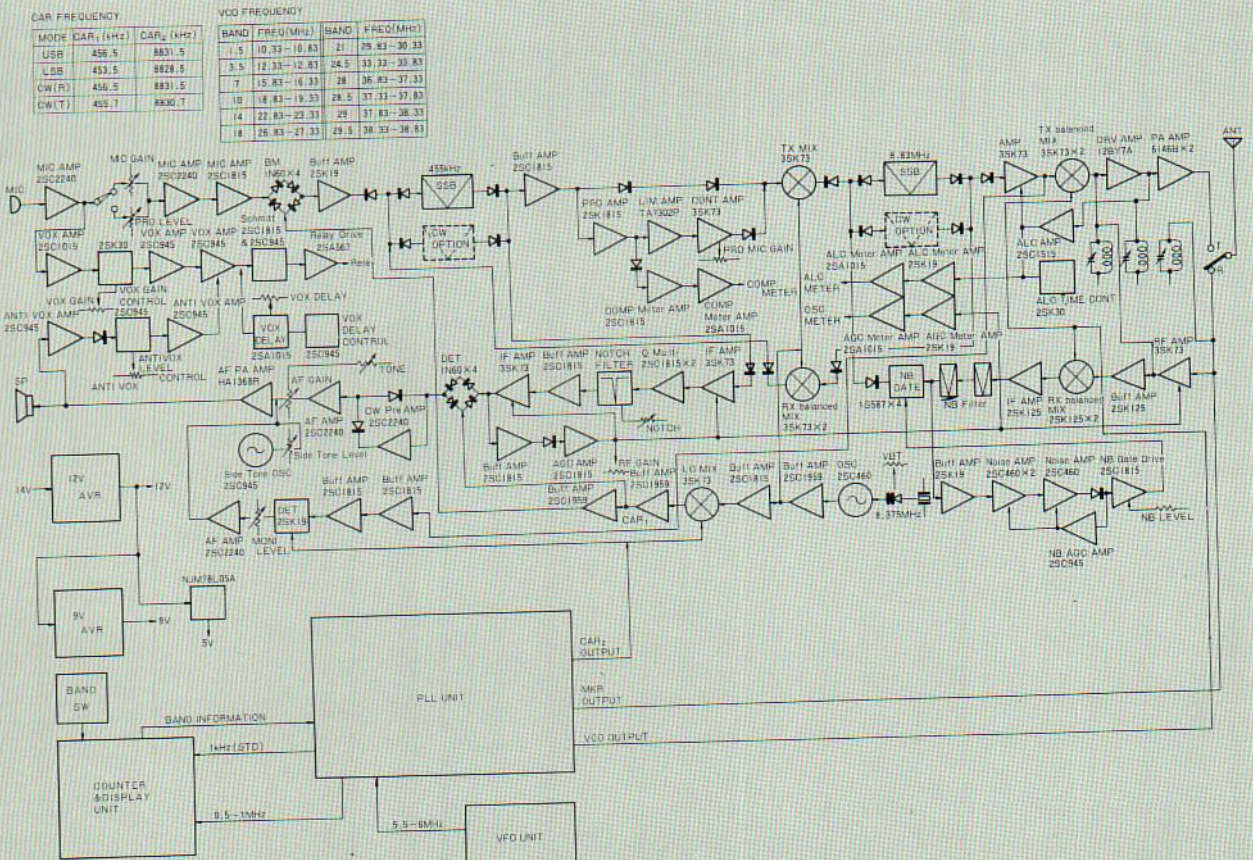

ificantly by shifting the passband in either direction. Making use of its high or low cutoff passband response in SSB, the desired signal may be adjusted to the desired tone pitch. In CW, likewise, its pitch may be varied by means of a combination of the IF shift and RIT.

### Various IF Filter Options [only for TS-830S]

The dual-conversion receiver (8.83 MHz and 455 kHz IF stages) in the TS-830S allow a combination of IF filters to be installed, in accordance with the user's requirements. Various combinations are shown in the chart below. By incorporating a low-frequency (455 kHz) IF, the attenuation characteristics of the entire IF section are extremely good. Furthermore, 455 kHz filters are very sharp, and either the YG-455C (500 Hz) or YG-455CN (250 Hz) filter may be installed.

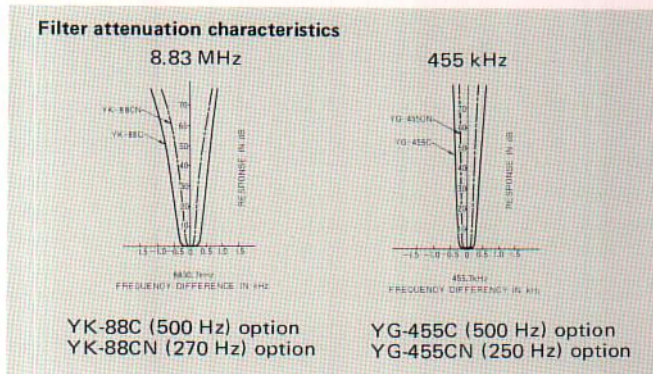

### Combination of IF filter

| MODE SWITCH | 8.83 MHz | 455 kHz            | Overall Pass-bandwidth | VBT               |                 |   |
|-------------|----------|--------------------|------------------------|-------------------|-----------------|---|
| SSB         | 2.7 kHz  | 2.7 kHz            | 2.4 kHz                | 500 Hz ~ 2.4 kHz  |                 |   |
| WIDE        | 2.7 kHz  | 2.7 kHz            | 2.4 kHz                | 500 Hz ~ 2.4 kHz  |                 |   |
| CW          | NARROW   | a (YK-88C 500 Hz)  | 2.7 kHz                | (500 Hz)          | *               |   |
|             |          | b (YK-88CN 270 Hz) | 2.7 kHz                | (270 Hz)          | *               |   |
|             |          | c                  | 2.7 kHz                | (YG-455C 500 Hz)  | (500 Hz)        | * |
|             |          | d                  | 2.7 kHz                | (YG-455CN 250 Hz) | (250 Hz)        | * |
|             |          | e (YK-88C 500 Hz)  | (YG-455C 500 Hz)       | (500 Hz)          | 150 Hz ~ 500 Hz |   |

- Notes: 1. ( ) = optional filter installation.  
 2. \* Although VBT circuit operates, optimum VBT characteristics cannot be expected due to the characteristic differences of 8.83 MHz and 455 kHz filters.  
 3. The optional 455 kHz filter YG-455C (500 Hz) and YG-455CN (250 Hz) have better skirt selectivity, because of low-frequency characteristics.

### Built-in Digital Display

A large, six-digit, fluorescent tube display is built into the TS-830S and TS-830M, backed up by an analog subdial. The digital display indicates the actual receive and transmit frequencies on all modes and all bands. This is achieved through a common division of the 10 MHz oscillator frequency for the PLL circuit, calibration circuit, and frequency counter. A Display Hold (DH) switch retains the display frequency while the VFO frequency is varied.

### 6146B Final with RF NFB

The TS-830S runs 220W PEP (SSB), 180W DC (CW), the TS-830M runs 220W PEP (SSB), 180W DC (CW), and 80W DC (AM) input and uses two 6146B's in the final amplifier. RF negative feedback provides optimum IMD characteristics for high-quality transmission.

### More Flexibility with Optional Digital VFO

The optional VFO-230 digital VFO operates in 20 Hz steps and includes five memories. The digital VFO, memory, and transceiver-VFO frequencies are interchangeable, for optimum operating flexibility in contests, DX chasing, split-frequency operation, and other applications. The VFO-230 covers about 100 kHz above and below each 500 kHz band. It includes a built-in digital display. (The remote VFO's for TS-130 series can also be operated with TS-830S and

TS-830M.)

### Innovative PLL System

The TS-830S and TS-830M utilize a new PLL circuit which does not require a crystal element for each band. As shown in the diagram, the VCO frequency is obtained in the PLL circuit by synthesizing the VFO and CAR frequencies, the 10 MHz reference frequency supplied by the counter, and the divided frequency of 500 kHz. Band changing is accomplished by changing the preset division ratio of the programmable divider in the PLL. This eliminates the need for a heterodyne crystal element for each operating band, resulting in simplification of circuitry, and a marked improvement in overall stability. Also, the VFO operates at the same frequency on each band. The PLL system improves the spurious characteristics during transmission and reception and makes IF shift operation and mono-dial indication available on any mode.

### RF Speech Processor

The efficient RF speech processor in the TS-830S and TS-830M, incorporating the 455 kHz IF stages, provides added audio punch and increases average SSB output power, whilst suppressing sideband splatter. Compression level can be controlled from the front panel and monitored on the meter.

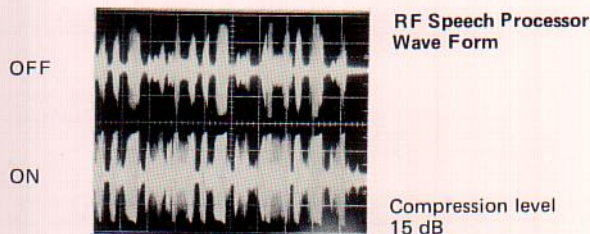

### Adjustable Noise-Blanker Level

The built-in noise blanker eliminates pulse-type (such as ignition) noise. A front-panel control adjusts the threshold level of the noise amplifier, to enhance the noise-blanker's effectiveness under various noise and signal levels.

### Adjustable Audio Tone

A front-panel tone control adjusts receiver audio frequency response for best readability under various conditions. An additional change in narrow audio frequency response is made automatically when switching to CW mode.

### RF Attenuator

The carefully designed receiver-section front end includes a 20 dB RF attenuator for optimum rejection of intermodulation distortion.

### RIT/XIT

Receiver incremental tuning (RIT) shifts only the receiver frequency, to tune in stations slightly off frequency. Transmitter incremental tuning (XIT) shifts only the transmitter frequency, when a DX station may be listening "off frequency". The digital display shows the correct frequency when RIT/XIT is used.

### SSB Monitor Circuit

A built-in monitor circuit monitors the transmit IF signal, to optimise audio quality and effect of RF speech processor.

### Extended Frequency Coverage

The TS-830S and TS-830M VFO covers more than 50 kHz above and below each 500 kHz band. The optional VFO-230 remote digital VFO covers about 100 kHz above and below each band, for other applications.



SP-230



TS-830S



VFO-230



AT-230

### VFO-230

Remote VFO



The VFO-230 digital VFO provides maximum efficiency and flexibility for all operating conditions, including split-frequency operation, by combining a 20 Hz step digital VFO with five memories.

#### FEATURES

• 20 Hz-step digital VFO: Provides excellent stability and smooth tuning on CW and SSB • Five Memories: Frequency can be transferred from VFO (transceiver or VFO-230) to memory or from memory to digital VFO (VFO-230) • Built-in digital display: Shows digital VFO or memory frequencies. The display range is selected automatically to cover 900.0–599.9 or 400.0–099.9, according to the band. Backed up by analog subdial with 1 kHz divisions • Cross-operation flexibility: Easy-to-operate function switch provides: RECEIVE/TRANSMIT: Main, RMT, Memo (Main: Transceiver VFO or FIX, RMT: VFO-230 digital VFO, MEM: Memory) • T-F SET switch: Allows operator to set transmit frequency quickly. Reverses transmit and receiver frequency momentarily, to prevent transmitting on wrong frequency during split-frequency operation • Expanded frequency coverage: About 100 kHz above and below each 500 kHz band • Lock switch: To prevent accidental frequency change • MAIN, RMT, and MEMO indicators: LEDs show functions in operation • Capability with TS-830S, TS-130 and TS-120 Series.

#### SPECIFICATIONS

• Oscillating Frequency: 5.4–6.1 MHz • Frequency Stability:  $1 \times 10^{-5}$  (at normal temperature),  $3 \times 10^{-5}$  (0–50°) • Output Voltage: 0.2V +3 dB, -1 dB • Power Requirement: 120/220/240V AC, 50/60 Hz, 13W • Dimensions: 180 (7.2)W x 133 (5.3)H x 287 (11.5)D mm • Weight: 3.1 kg (6.8 lbs)

### AT-230

Antenna Tuner



The AT-230 antenna tuner includes the new three bands and functional features such as a through-line wattmeter, SWR meter and antenna selector switch.

The AT-230 greatly adds to the effectiveness of your station.

#### SPECIFICATIONS

(ANTENNA COUPLER) • Frequency Range: 9 amateur bands from 1.8 to 30.0 MHz • Input Impedance: 50Ω • Output Impedance: 10 to 500Ω, unbalanced • Through Power: 200W max. (WATT-METER) • Type: Through line wattmeter • Frequency Range: 1.8 to 30.0 MHz • Measurable RF Power: Up to 20/200W, switched • Kinds of RF Power: Forward and reflected power, switched • Impedance: 50Ω • Accuracy: Better than ±10% of full scale (SWR METER) • SWR detection: Toroidal core directional coupler • Measurable Range: 1.1 to 10 • Min. Power Required: 4W (GENERAL) • Connectors, INPUT: UHF type, 50Ω • Connectors, ANT-1: UHF type; ANT-2: UHF type; ANT-3: Wire antenna only; GND • Dimensions: 180 (7.2)W x 133 (5.3)H x 287 (11.5)D mm (inch) • Weight: 3.4 kg (7.5 lbs)

### SP-230

External Speaker



The SP-230 external speaker matches the TS-830S HF transceiver. It is a low-distortion speaker with selectable frequency response for high intelligibility in any mode. The frequency response is determined by the built-in audio filters, which are effective in improving signal-to-noise ratio under certain interference conditions, or when receiving weak signals. On the front panel is a headphone connector, for listening to audio output passed through the filters. Also on the front panel is a switch for selecting either of two audio inputs to the SP-230.

#### SPECIFICATIONS

• Maximum Input (nominal): 2W • Impedance: 8Ω • Frequency Response: 300 Hz to 5 kHz • Filter Cut off Frequency: Low = 400 Hz/-3 dB, High 1 = 3 kHz/-3 dB, High 2 = 1.5 kHz/-3 dB, High 1 and High 2 = 1.0 kHz/-3 dB • Filter Attenuation Characteristic: -6 dB/Oct. • Dimensions: 180 (7.2)W x 133 (5.3)H x 287 (11.5)D mm (inch) • Weight: 1.8 kg (4.0 lbs)

### TL-922

HF Linear Amplifier



The TL-922 is an HF linear amplifier operating at maximum legal power, and employing a pair of 3-500Z high performance transmitting tubes. (without the three new amateur bands.)

#### SPECIFICATIONS

• Frequency Range: 160 meter band—1.8 to 2.0 MHz, 80 meter band—3.5 to 4.0 MHz, 40 meter band—7.0 to 7.3 MHz, 20 meter band—14.0 to 14.35 MHz, 15 meter band—21.0 to 21.45 MHz, 10 meter band—28.0 to 29.7 MHz • Mode: SSB, CW, RTTY • Drive power: 80W or more for full output • RF Input Power: SSB; 2,000W PEP, CW, RTTY; 1,000W DC • Circuitry: AB<sub>2</sub> Class Grounded-grid Linear Amplifier • Input Impedance: 50Ω • Output Impedance: 50 to 75Ω • Tubes: EIMAC 2 x 3-500Z (option) • Power Requirements: 120/220/240V AC, 50/60 Hz • Dimensions: 390 (15.6)W x 190 (7.6)H x 407 (16.3)D mm (inch) • Weight: 31 kg (68 lbs)

(W.M) 810330H Printed in Japan

A product of  
**TRIO-KENWOOD CORPORATION**  
17-5, 2-chome, Shibuya, Shibuya-ku, Tokyo 150, Japan

**TRIO-KENWOOD COMMUNICATIONS, INC.**  
1111 West Walnut Street, Compton, California 90220, U.S.A.  
**TRIO-KENWOOD COMMUNICATIONS, GmbH**  
D-8374 Steinbach TS Industriestrasse BA, West Germany  
**TRIO-KENWOOD ELECTRONICS, N.V.**  
Leuvensesteenweg 504, B-1930 Zaventem, Belgium  
**TRIO-KENWOOD (AUSTRALIA) PTY. LTD.**  
30 Whiting Street, Artarmon, Sydney N.S.W. Australia 2064