

FM7W00D

TW-4100A

144/430MHz FM DUAL BANDER

TW-4100A

TW-4100E

INSTRUCTION MANUAL

CONTENTS

1. BEFORE OPERATION	3
2. SPECIFICATIONS AND ACCESSORIES	4
2-1. SPECIFICATIONS	4
2-2. ACCESSORIES	5
3. INSTALLATION AND CONNECTION	6
3-1. INSTALLATION (MOBILE)	6
3-2. CONNECTION	6
4. OPERATION	9
4-1. CONTROLS AND THEIR FUNCTIONS	9
4-2. RECEPTION	13
4-3. TRANSMISSION	15
4-4. MEMORY	16
4-5. SCAN	17
4-6. REPEATER	17
4-7. DCL (Digital Channel Link) SYSTEM	18
4-8. VOICE SYNTHESIZER	18
5. MAINTENANCE AND ADJUSTMENTS	25
5-1. GENERAL INFORMATION	25
8. REFERENCE	25
8-1. ANTENNA	25
8-2. MOBILE INSTALLATION	25
7. OPTIONAL ACCESSORIES	31
7-1. TU-7 TONE UNIT	31
7-2. MU-1 MODEM UNIT	31
7-3. VS-2 VOICE SYNTHESIZER UNIT	32
7-4. OTHER ACCESSORIES	32
6. BLOCK DIAGRAM AND CIRCUIT DIAGRAM	37
6-1. BLOCK DIAGRAM	37
6-2. CIRCUIT DIAGRAM	38
5.6. ORDERING SPARE PARTS	38
5.7. ADJUSTMENTS	38
5.8. MICROPROCESSOR BACKUP LITHIUM BATTERY REPLACEMENT	37
5.4. IN CASE OF DIFFICULTY	37
5.3. CLEANING	37
5.2. SERVICE	37

©PRINTED IN JAPAN B50-8142-20(K,M,T,W)(G)
88/12 11 10 9 8 7 6 5 4 3 2 1 87/12 11 10 9 8 7 6 5

Downloaded by
RadioAmateur.EU

1. BEFORE OPERATION

Safety precautions

Never remove the case unless specified in this Instruction Manual. If the internal parts are touched accidentally, a serious electric shock might occur.

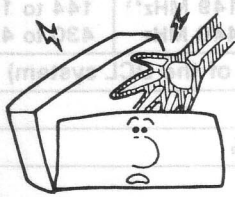

Never touch internal parts.

If a metal object, such as a hair pin or a needle, comes into contact with the power socket on the rear panel, a dangerous electric shock may result. For families with children, never permit children to put anything, especially metal, inside this unit.

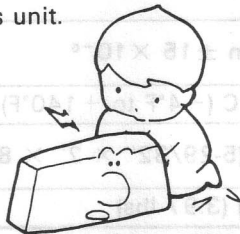

Touching the power plug when your hands are wet may result in a serious electric shock.

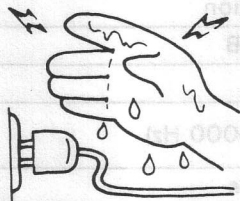

Never touch with wet hands.

Never pull, bend or extend the power cord. This could damage the power cord, resulting in a broken cord or short-circuit.

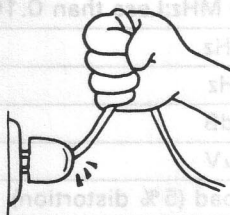

Always grasp the plug.

In case of abnormal smell

If an abnormal smell or smoke is detected, immediately turn the power OFF and pull out the power cord. Contact your dealer or nearest Service Station.

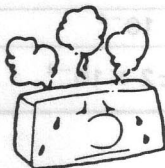

Where to install the unit

Do not place the unit near a heat producing equipment such as a radiator. Avoid direct sunlight.

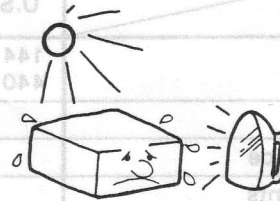

Do not store or use the unit in a dusty location or in a moist atmosphere. Select a location where air is well ventilated.

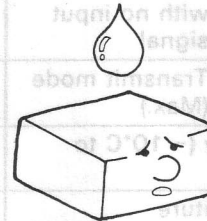

To maintain good ventilation, do not put records or a tablecloth on the unit. Place the unit at least 10 cm away from the walls.



Install the unit on a flat, vibration-free rigid table.

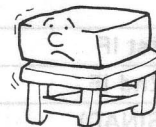

The unit may not function properly if used at extremely low, or freezing temperatures.



Cleaning

Do not use volatile solvents such as alcohol, paint thinner, gasoline, benzine, etc. to clean the cabinet. Use a silicone cloth or a clean dry cloth.

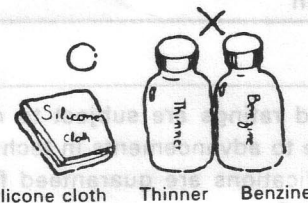

Silicone cloth Thinner Benzine

8. REFERENCE

8-1. ANTENNA

8-1-1. Fixed Station

Various types of fixed station antennas are commercially available. Select your antenna according to available space and intended application. Transceiver performance depends largely on the type of antenna used. For fixed station operation there are ground plane antennas (omnidirectional) and Yagi antennas (unidirectional). The Yagi antenna is suitable for DX (Long distance) operation or communication with a specific party.

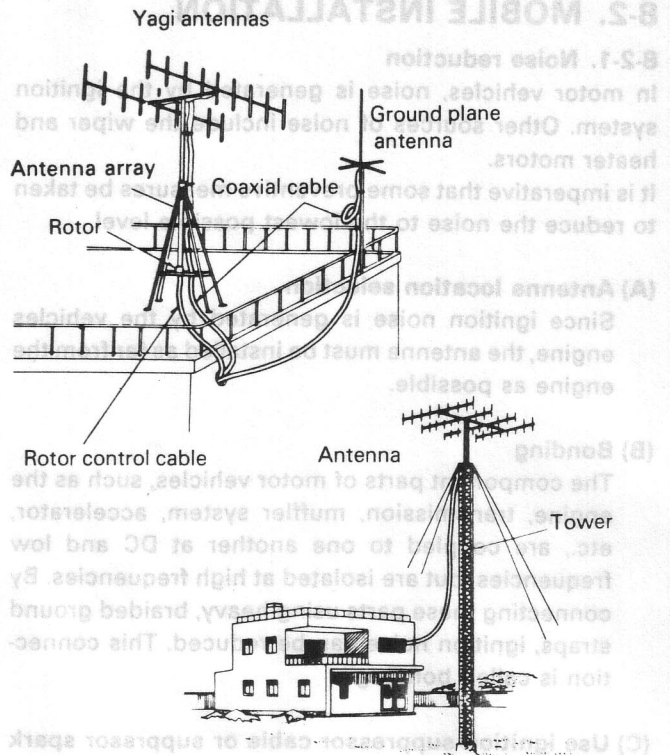

8-1-2. Mobile

Various types of antennas for VHF/UHF mobile operation are available.

Note: _____

For gutter-mount installation, the antenna bracket must be grounded to the car body as shown below. Attach the antenna securely, referring to the antenna installation instructions provided with the antenna.

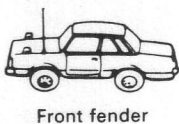
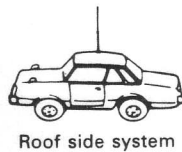
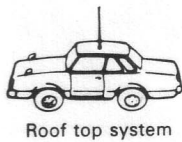

Installation for mobile operation

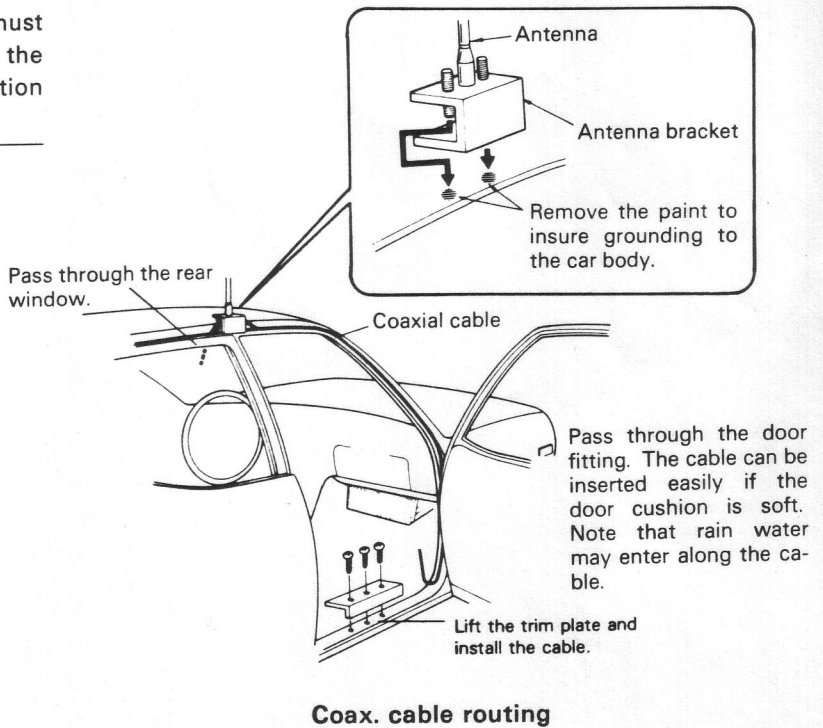

■ **MC-43S UP/DOWN HAND MICROPHONE**

The MC-43S is handy dynamic microphone with PTT switch and UP/DOWN switches.

■ **MB-11 MOBILE MOUNT**

The mobile mount MB-11 allows easy installation and removal of the TW-4 100A/4 100E.

■ **CD-10 CALL SIGN DISPLAY**

The CD-10 stores the call sign of the calling station in its memory and displays it on an LCD display. Call signs of up to 20 of the most recently calling stations are stored. Allowing the operator to quickly check for and return any call.

■ **PG-2N DC POWER CABLE**

■ **PG-3B DC LINE NOISE FILTER**

May be used with the TW-4 100A/4 100E to suppress ignition noise.

■ **SW-200B SWR/POWER METER (supplied with a coupler)**

SW-200B supplied with SWC-2. Selectable peak-reading/RMS. SWR/POWER meters cover 140 ~ 450 MHz in range of 0 ~ 20/200W, full scale for base station use.

■ **SW-100B SWR/POWER METER**

Compact and lightweight SWR/POWER/VOLT meters cover 140 ~ 450 MHz in range of 150W full scale for mobile use.

■ **SWT-1/SWT-2 ANTENNA TUNING UNIT**

The SWT-1 (2m band) and the SWT-2 (70 cm band) are an antenna tuning unit designed for use in conjunction with an SWR/POWER meter to allow efficient transmission. This unit is especially convenient for monitoring SWR, using a KENWOOD SWR/POWER meter.

■ **MA-4000 VHF/UHF DUAL BAND MOBILE ANTENNA (Duplexer supplied)**

The MA-4000 is a dual band (2 m/70 cm) mobile antenna supplied with a duplexer.

The duplexer connects to both the 144 MHz band and 430/440 MHz band antenna terminals on a dual band transceiver.



MC-43S



MC-85

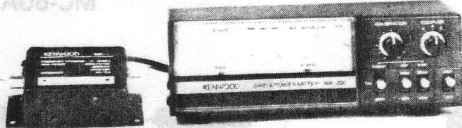

SW-200B

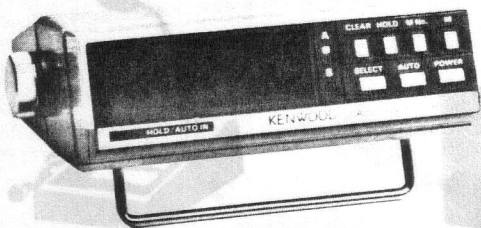

CD-10

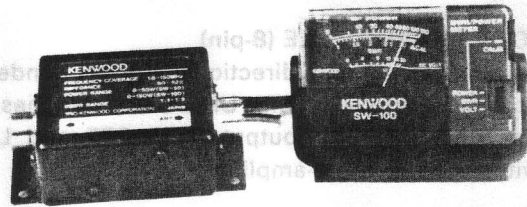

SW-100B



SWT-1/SWT-2

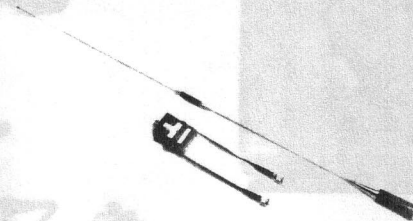

MA-4000

7-4. OTHER ACCESSORIES

■ PS-50 HEAVY DUTY DC POWER SUPPLY

May be used with the TW-4100A/4100E for stable operation.

■ PS-430 DC POWER SUPPLY

May be used with the TW-4100A/4100E for stable operation.

■ SP-430 EXTERNAL SPEAKER

The SP-430 is an attractive, compact external speaker. This low-distortion speaker provides clear reproduction of the high-quality audio obtained from the transceiver.

■ SP-50 MOBILE SPEAKER (8 ohms)

Compact and smart high quality external speaker provides flexibility of installation for maximum convenience.

■ SP-40 COMPACT MOBILE SPEAKER (4 ohms)

■ MC-85 MICROPHONE (8-pin)

The MC-85 is a unidirectional high-class electret condenser microphone provided with the output selective switch, audio level compensation circuit, low cut filter, level meter, PTT and LOCK switches.

■ MC-80 MICROPHONE (8-pin)

The MC-80 is an omnidirectional electret condenser microphone provided with UP/DOWN switches, volume adjustment for output level, PTT and LOCK switches, built-in pre-amplifier.

■ MC-60A MICROPHONE (8-pin)

The zinc die-cast base provides high stability, and the MC-60A is complete with PTT and LOCK switches, UP/DOWN switches, and impedance selector switch and a built-in pre-amplifier.

■ MC-55 MOBILE MICROPHONE (8-pin)

The MC-55 provides UP/DOWN switches, LED display for switching transmit or receive, adjustable microphone gain, automatic receive returning circuit (approx. 5 minutes) and many functions.

■ MC-48B AUTOPATCH UP/DOWN HAND MICROPHONE (8-pin)

The MC-48B is 16-key autopatch UP/DOWN microphones with PTT switch. Encodes 16 autopatch tones. UP/DOWN switches provide step frequency change, or initiate band scan in the appropriate direction, if held depressed momentarily.

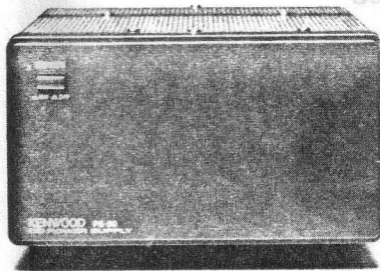

PS-50



SP-430



MC-48B

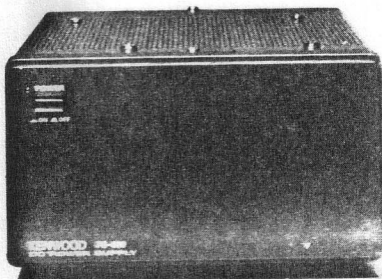

PS-430

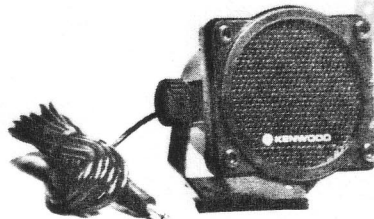

SP-40



MC-60A

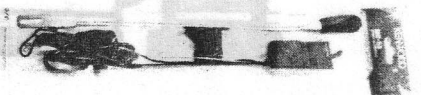

MC-55

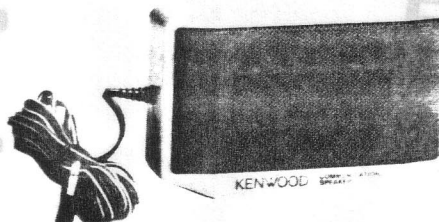

SP-50



MC-80

7-3. VS-2 VOICE SYNTHESIZER UNIT

1. Remove the bottom cover.
2. Insert the 8-pin connector of the cable harness onto the VS-2 and the 3-pin connector onto the main chassis as shown in the accompanying diagram.
3. Install the VS-2 onto the chassis using the self tapping screws and the countersunk screws that were supplied with the VS-2.
4. Attach the foam pad that was supplied with the VS-2 to the VS-2 as illustrated.
5. Replace the bottom cover. Ensure that there are no pinched wires between the bottom cover and the chassis.

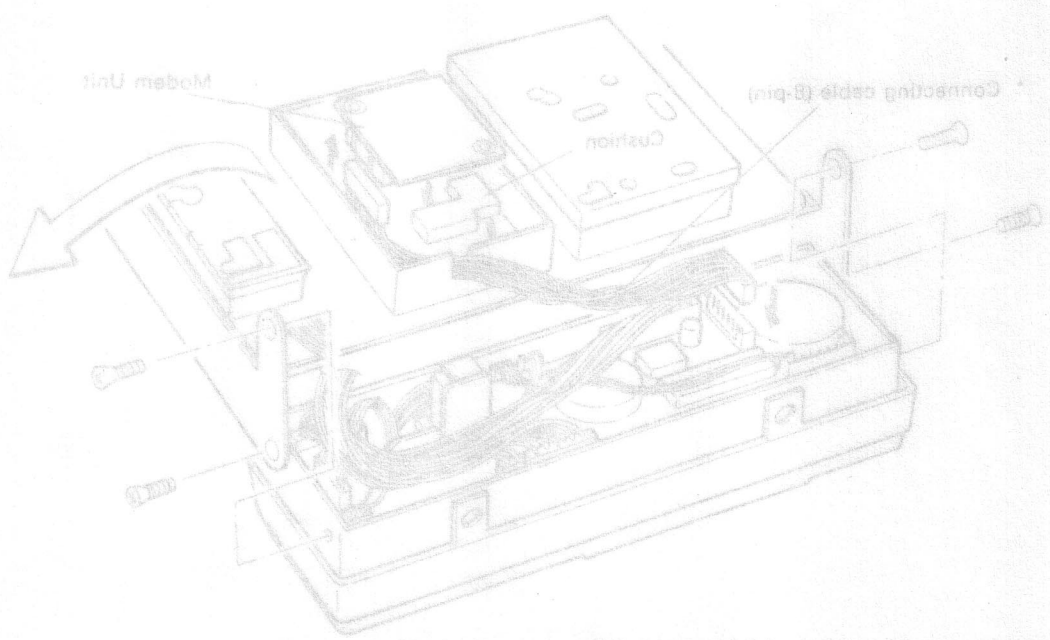
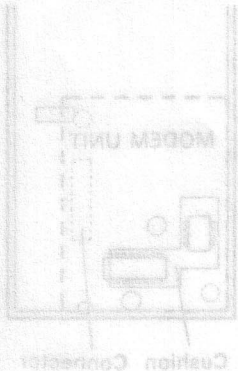
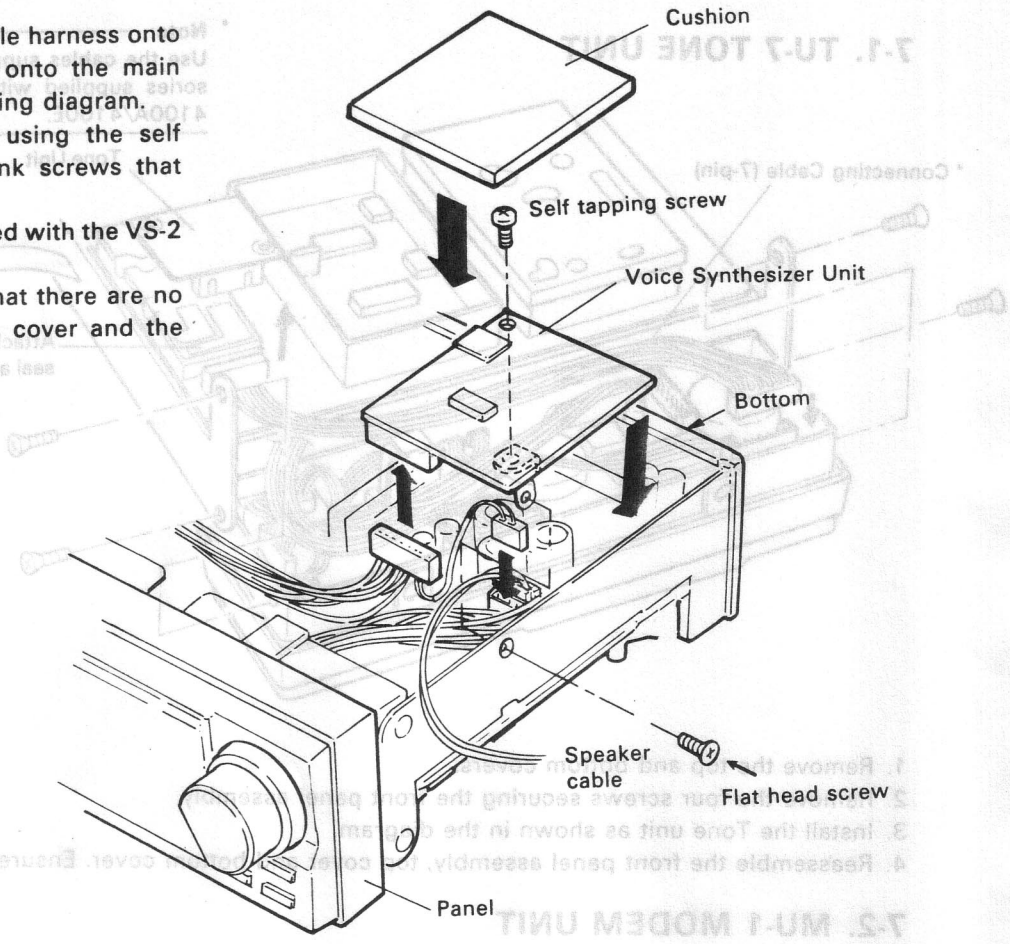
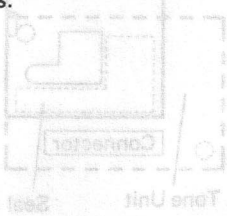

Note:
Use the cables supplied with the TW-4100A/100E Accessory.
The cables supplied with the MU-1 are not used with the TW-4100A/100E.

1. Remove the top and bottom covers.
2. Remove the four screws fastening the front panel assembly.
3. Install the Modem Unit as shown in the diagram.
4. Reassemble the front panel assembly, top cover and bottom cover. Ensure you do not pinch any wires.
5. Turn the power ON while depressing the DCL key.

7. OPTIONAL ACCESSORIES

7-1. TU-7 TONE UNIT

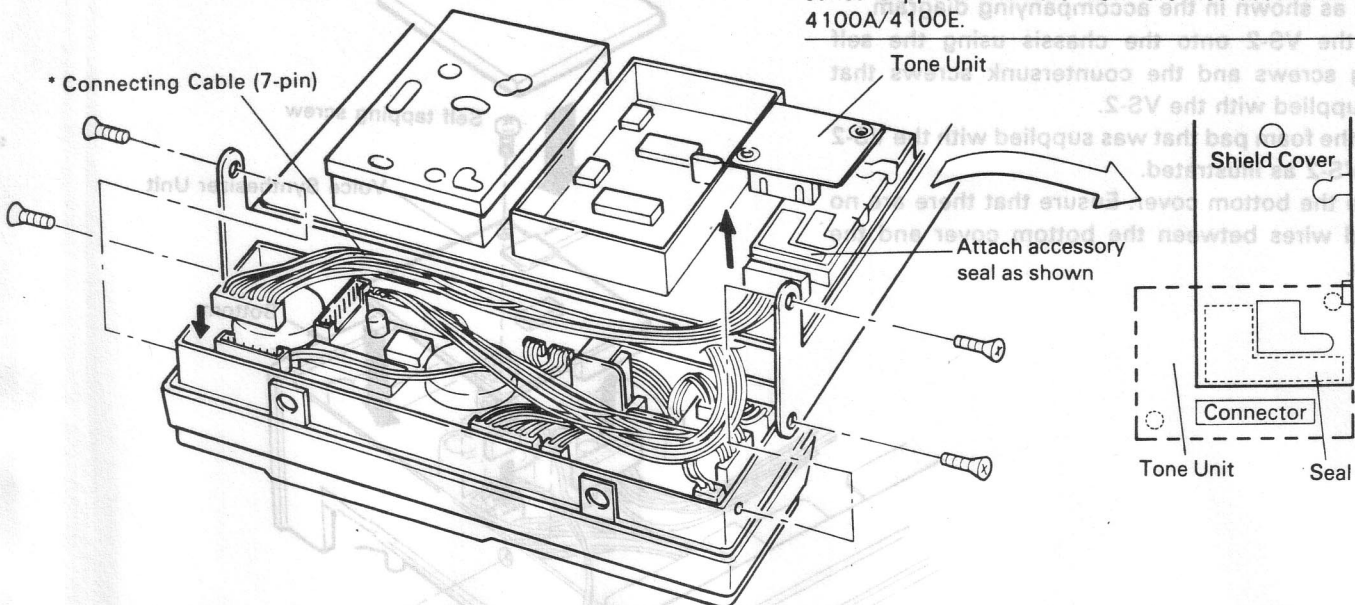

Note:

Use the cables supplied with the TW-4100A/4100E. Accessories supplied with the TU-7 are not used with the TW-4100A/4100E.

1. Remove the top and bottom covers.
2. Remove the four screws securing the front panel assembly.
3. Install the Tone unit as shown in the diagram.
4. Reassemble the front panel assembly, top cover and bottom cover. Ensure you do not pinch any wires!

7-2. MU-1 MODEM UNIT

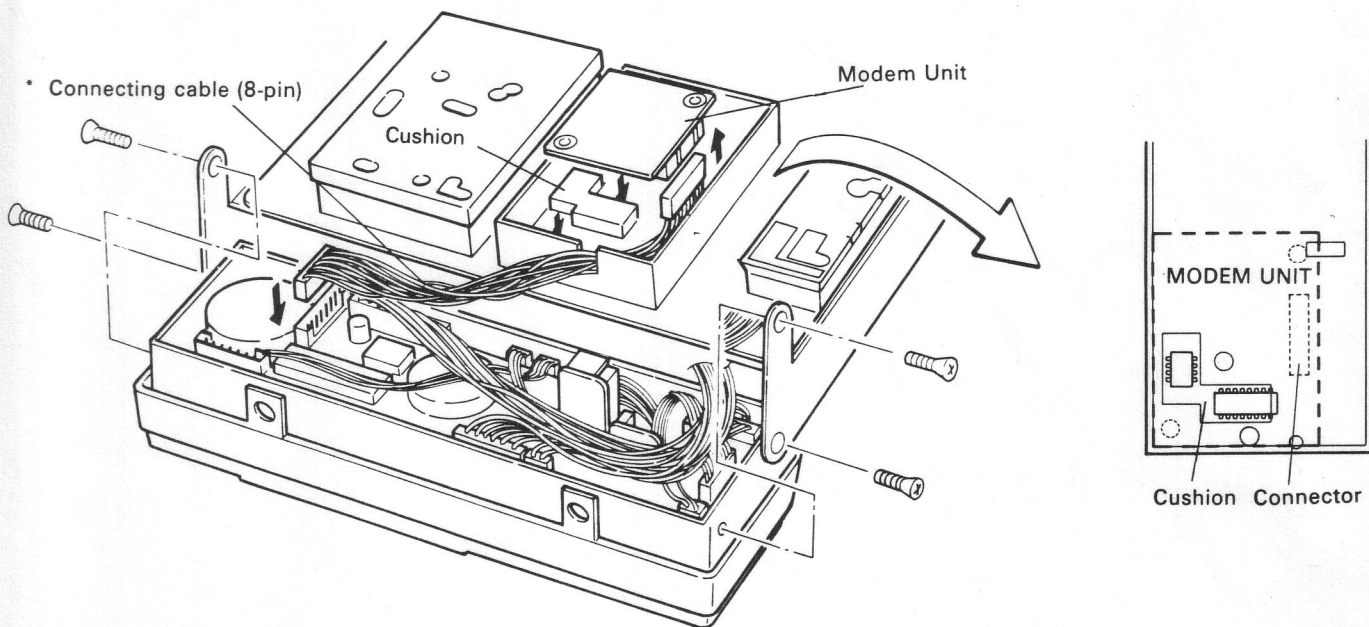

1. Remove the top and bottom covers.
2. Remove the four screws fastening the front panel assembly.
3. Install the Modem Unit as shown in the diagram.
4. Reassemble the front panel assembly, top cover and bottom cover. Ensure you do not pinch any wires!
5. Turn the power ON while depressing the DCL key.

Note:

Use the cables supplied with the TW-4100A/4100E. Accessories supplied with the MU-1 are not used with the TW-4100A/4100E.

5-7. ADJUSTMENTS

5-7-1. Cover Removal

1. Remove the 4 screws securing the top cover.
2. Remove the 10 screws that secure the bottom cover.
3. Be careful when removing the bottom cover that you do not damage the speaker cable.
4. To reinstall the covers reverse the above procedure. Do not pinch any wires when installing the covers.

5-7-2. Low power output

1. 2 meter low power adjustment
Turn VR7 during low power transmission to adjust the power output in a range of about 1 to 45 watts. (Fig. 1)
2. 70 cm band low power adjustment
Turn VR5 during low power transmission to adjust the power output in a range of about 1 to 35 watts. (Fig. 1)

5-7-3. Tone deviation (TW-4100A only. Using TU-7)

1. 2 meter tone deviation adjustment
The 2 meter tone deviation is controlled by VR4 shown in Fig. 1.
2. 70cm band tone deviation adjustment
The 70cm band tone deviation is controlled by VR2 shown in Fig. 1.

5-7-4. 1750 Hz tone deviation (TW-4100E only)

The 1750 Hz tone deviation is controlled by VR10 shown in Fig. 2.

5-7-5. Beep tone level

Turn VR5 to the desired beep tone volume. (Fig. 2)

5-7-6. Microphone gain

The mic gain is controlled by VR2 shown in Fig. 2.

5-7-7. Frequency step selection for the open channel search. (TW-4100A only) (Fig. 3)

Cut D2 to change channel steps from 15 kHz to 20 kHz in an open channel search operation. (Refer to the section 4-7-7.)

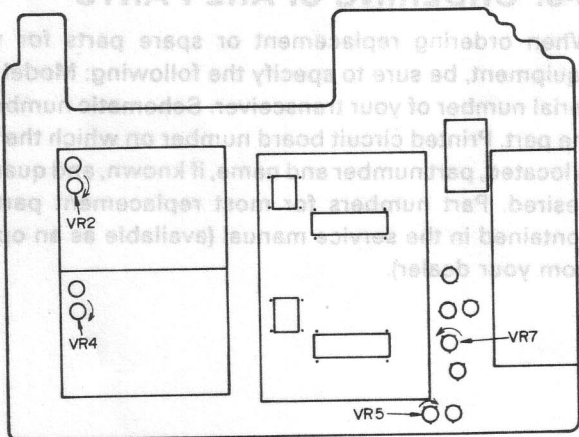
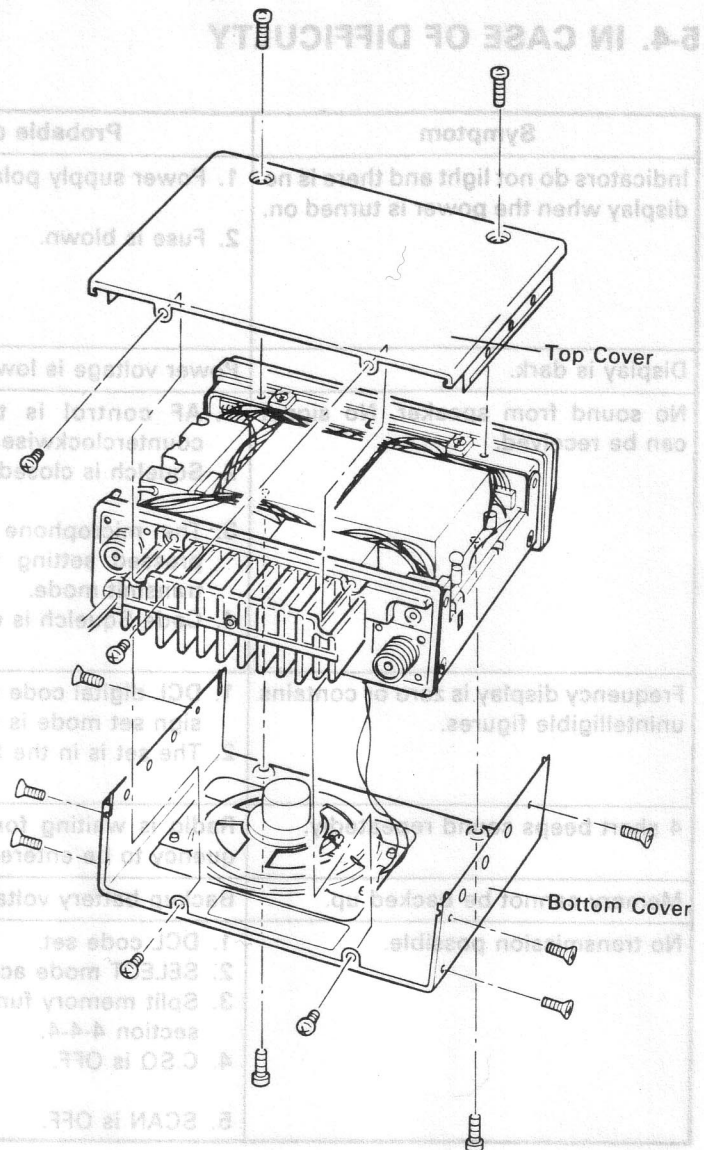

Fig. 1

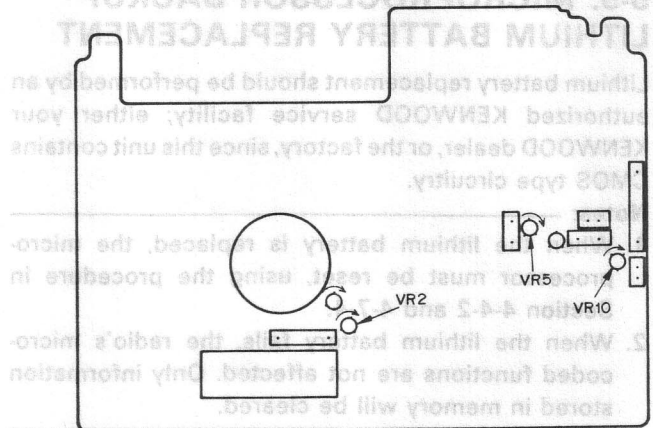

Fig. 2

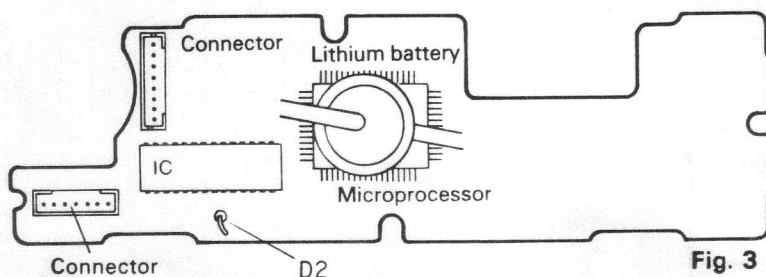
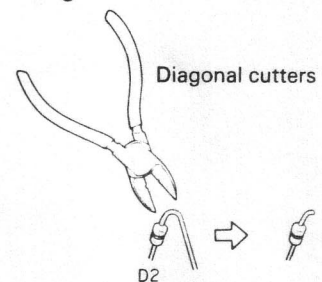

Fig. 3



5-4. IN CASE OF DIFFICULTY

Symptom	Probable cause	Action
Indicators do not light and there is no display when the power is turned on.	<ol style="list-style-type: none"> 1. Power supply polarity reversed. 2. Fuse is blown. 	<ol style="list-style-type: none"> 1. Connect red to "+" and black to "-". 2. The short cable attached to the transceiver contains a 10 Amp fuse. (The DC power cable has a 20 A safety fuse in both leads.)
Display is dark.	Power voltage is low.	Check voltage for 13.8 VDC \pm 15%.
No sound from speaker. No signal can be received.	<ol style="list-style-type: none"> 1. AF control is turned too far counterclockwise. 2. Squelch is closed. 3. The microphone PTT switch is pressed setting the unit in the transmit mode. 4. Code Squelch is operating. 	<ol style="list-style-type: none"> 1. Turn the VOL control. 2. Turn the SQL control counterclockwise. 3. Turn PTT switch off. 4. Press C.SQ switch to clear code squelch.
Frequency display is zero or contains unintelligible figures.	<ol style="list-style-type: none"> 1. DCL digital code set mode or call sign set mode is ON. 2. The set is in the SEL mode. 	<ol style="list-style-type: none"> 1. Press CS key. 2. End the SEL mode by pressing the SEL key.
4 short beeps sound repeatedly.	Radio is waiting for a transmit frequency to be entered.	Select the desired transmit frequency, and press the M key.
Memory cannot be backed up.	Backup battery voltage is low.	See section 5-5.
No transmission possible.	<ol style="list-style-type: none"> 1. DCL code set. 2. SELECT mode active. 3. Split memory function active see section 4-4-4. 4. C.SQ is OFF. 5. SCAN is OFF. 	<ol style="list-style-type: none"> 1. Press the CS key. 2. End the SEL mode. 3. Enter a transmit frequency and press the M key. 4. Release and then press the PTT switch again.

5-5. MICROPROCESSOR BACKUP LITHIUM BATTERY REPLACEMENT

Lithium battery replacement should be performed by an authorized KENWOOD service facility; either your KENWOOD dealer, or the factory, since this unit contains CMOS type circuitry.

Notes:

1. When the lithium battery is replaced, the microprocessor must be reset, using the procedure in Section 4-4-2 and 4-7-4.
2. When the lithium battery fails, the radio's micro-coded functions are not affected. Only information stored in memory will be cleared.

5-6. ORDERING SPARE PARTS

When ordering replacement or spare parts for your equipment, be sure to specify the following: Model and serial number of your transceiver. Schematic number of the part. Printed circuit board number on which the part is located, part number and name, if known, and quantity desired. Part numbers for most replacement parts is contained in the service manual (available as an option from your dealer).

Downloaded by
RadioAmateur.EU

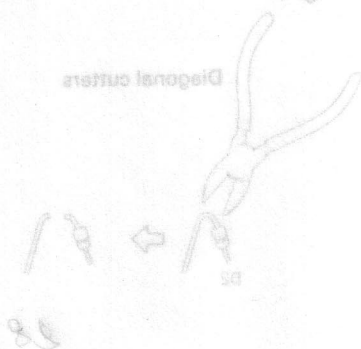

27

5. MAINTENANCE AND ADJUSTMENTS

5-1. GENERAL INFORMATION

Your transceiver has been factory aligned and tested to specification before shipment. Under normal circumstances the transceiver will operate in accordance with these operating instructions. All adjustable trimmers and coils in your transceiver were preset at the factory and should only be readjusted by a qualified technician with proper test equipment.

5-2. SERVICE

Should it ever become necessary to return the equipment to your dealer or service center for repair, pack it in its original box and packing, and include a full description of the problems involved. Also include your telephone number. You need not return accessory items unless directly related to the service problem.

You may return your radio for service to the Authorized KENWOOD Dealer from whom you purchased it. A copy of the service report will be returned with the unit. Please do not send sub-assemblies or printed circuit boards. Send the complete unit, in its original boxes and packing.

Tag all returned items with your name and call for identification. Please mention the model and serial number of your radio in any correspondence, whether phone or written. For future reference, record this information in the space provided on the back cover of this manual.

5-3. CLEANING

The knobs, front panel and cabinet of the transceiver are likely to become soiled after extended use. The knobs should be removed from the transceiver and cleaned

Attempting service or alignment without factory authorization can void the transceiver's warranty.

When operated properly, the transceiver will provide many years of service without requiring realignment. The information in this section gives some general service procedures which can be accomplished without sophisticated test equipment.

Service note:

Dear OM, if you desire to correspond on a technical or operational problem, please make your note short, complete, and to the point, and PLEASE make it readable.

Please list: Model and serial number.

The problem you are having.

Please give sufficient detail to diagnose. Information such as other equipment in the station, meter readings and anything you feel might be useful in attempting diagnosis.

Caution:

Do not pack the equipment in crushed newspaper for shipment! Extensive damage may result during shipping.

Notes:

1. Record the date of purchase, serial number and dealer from whom purchased.
2. For your own information, retain a written record of any maintenance performed on the unit.
3. When claiming warranty service, please include a photocopy of the bill of sale, or other proof of purchase showing the date of sale.

with a neutral soap and warm water. Use a neutral soap (not harsh chemicals) and damp cloth to clean the cabinet and front panel.

4-8. VOICE SYNTHESIZER

(Requires the use of the optional VS-2 Voice Synthesizer)

When the VOICE/SQL control is pressed the transceiver will audibly announce the operating frequency, offset, and memory channel number.

Example:

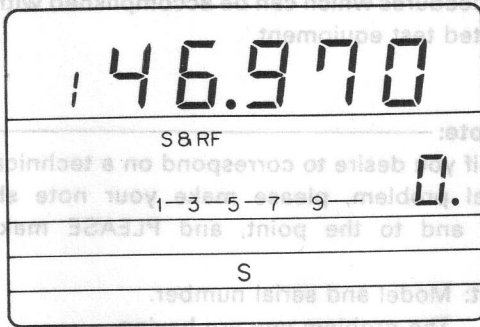

1. one, four, six, point, nine, seven, zero, simplex.
2. Frequency.
3. Memory channel (When operating in the VFO mode no memory channel number will be sounded.)
4. Shift direction (When operating on memory channel M8 or M9 no shift direction will be sounded.)
5. When operating the SEL (select) key or programming DCL parameters no information will be sounded.

Notes:

1. Record the date of purchase, serial number and dealer from whom purchased.
2. For your own information, retain a written record of any maintenance performed on the unit.
3. When claiming warranty service, please include a photocopy of the bill of sale, or other proof of purchase showing the date of sale.

With a neutral soap and warm water. Use a neutral soap (not harsh chemicals) and damp cloth to clean the cabinet and front panel.

5-1. GENERAL INFORMATION

Your transceiver has been factory aligned and tested to specification before shipment. Under normal circumstances the transceiver will operate in accordance with these operating instructions. All adjustable trimmers and coils in your transceiver were preset at the factory and should only be readjusted by a qualified technician with proper test equipment.

5-2. SERVICE

Should it ever become necessary to return the equipment to your dealer or service center for repair, pack it in its original box and packing, and include a full description of the problems involved. Also include your telephone number. You need not return accessory items unless directly related to the service problem. You may return your radio for service to the Authorized KENWOOD Dealer from whom you purchased it. A copy of the service report will be returned with the unit. Please do not send sub-assemblies or printed circuit boards. Send the complete unit, in its original box and packing. Tag all returned items with your name and call for identification. Please mention the mode and serial number of your radio in any correspondence, whether phone or written. For future reference, record this information in the space provided on the back cover of this manual.

5-3. CLEANING

The knobs, front panel and cabinet of the transceiver are likely to become soiled after extended use. The knobs should be removed from the transceiver and cleaned

- Convert your call sign to a decimal number using the accompanying chart. You must enter a total of 6 characters. For shorter call signs use leading or trailing spaces (decimal 32).

For example:

Call sign:	W	D	6	D	J	Y
Decimal ASCII	87	68	54	68	74	89
Call sign:	-	K	R	6	T	-
Decimal ASCII	32	75	82	54	84	32

Your call sign					
Decimal ASCII notation					

- Press the CS key to display the digital code.



- Press the RESET key to display the first ASCII character position. The figure below shows an example display.

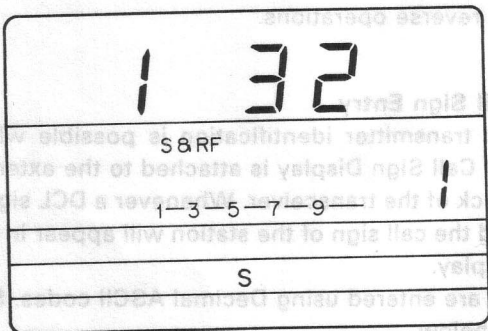

- Press the SHIFT key repeatedly until the first digit of the first character appears. Using the first example above (WD6DJY) we would press the SHIFT key until 8 appears in the display. Then press the TONE key until the second digit appears, 7. The first character (W) now appears as (1 87) in the display.

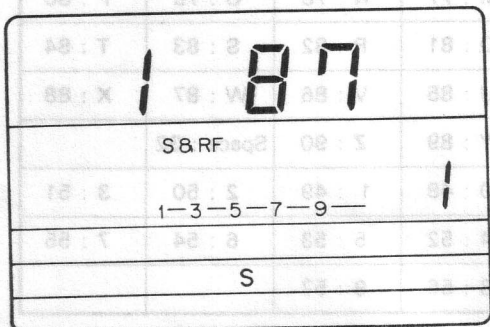

- Press the C. SQ key to advance to the next call sign character position. Press the SHIFT key until 6 appears, and the TONE key until 8 appears.

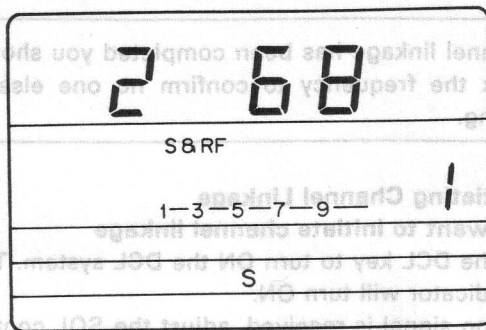

- Press the C. SQ key to advance to the next character and continue to enter the characters until you have entered the final character (89 = Y).

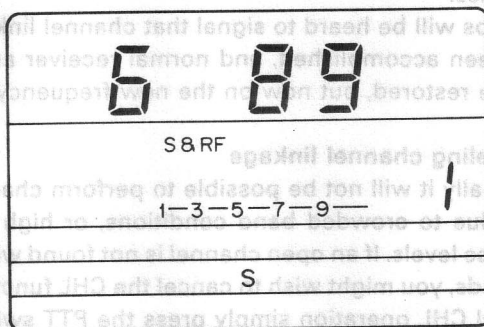

After you have entered the final 9 in the "Y" you can either return to the normal frequency display by pressing the CS key, or review the call sign data character by character by pressing the C. SQ key to step thru the positions.

This call sign will remain until the microprocessor is reset, or you manually reprogram the data.

Open channel criteria

If squelch is closed (BUSY Indicator is OFF) for more than 1.5 seconds, the channel is considered to be the open channel.

Note:

After channel linkage has been completed you should still check the frequency to confirm no one else is transmitting.

4-7-8. Initiating Channel Linkage

1. If you want to initiate channel linkage

1. Press the DCL key to turn ON the DCL system. The DCL indicator will turn ON.
2. When no signal is received, adjust the SQL control until the BUSY indicator goes OFF.
3. Press the CHL key. Operation 4-7-6 1 through 4 will be performed. The CHL indicator will flash and the speaker will be muted while channel search is in progress.
4. 4 beeps will be heard to signal that channel linkage has been accomplished, and normal receiver audio will be restored, but now on the new frequency.

A. Canceling channel linkage

Occasionally it will not be possible to perform channel linkage due to crowded band conditions, or high ambient noise levels. If an open channel is not found within 30 seconds, you might wish to cancel the CHL function. To cancel CHL operation simply press the PTT switch.

B. Recall function

It is possible that due to band conditions or interference the distant station may not receive enough data to change to the new frequency. If this occurs you can return to the original operating frequency and try again by simply pressing the CHL key. If you do this after your transceiver has changed to the open channel the radio will return to the original operating frequency and retransmit the Channel linkage data.

C. Reverse operation

If after several attempts to complete channel linkage it has not been possible to shift the distant station to the new frequency you can manually return to the original operating frequency and inform the distant station verbally of the new operating frequency.

1. Press the RESET key. The CHL indicator will go OFF.
2. Press the RESET key again to return to the original operating frequency.
3. Press the PTT switch and announce the new frequency.
4. After confirming the frequency with the other station(s) press the RESET key to return to the new frequency.
5. Each time you press the RESET key you will switch between the old and new frequencies.

D. Reinitiating channel linkage

If you want to try channel linkage after failures due to interference that might have been present on the new channel:

1. Press the RESET key. The CHL indicator should be OFF.
2. Press the PTT switch and ask the distant station(s) to press their RESET keys.
3. Press the CHL key to initiate channel linkage. The transceiver will search for a frequency that is not occupied.

2. Distant station initiates channel linkage

1. Ensure that the Access code of your station matches that of the distant station.
2. Press the DCL key. The DCL indicator will go ON.
3. Ask the other station to press the CHL key. A control signal will soon be received from the distant station if an open channel is found.
4. The transceiver will switch to this new frequency, and 4 short beeps will sound to indicate channel linkage has been completed.

3. Channel linkage notes

Channel linkage will not occur under the following conditions even if the proper control code is received.

1. When channel linkage has just been completed and the CHL indicator is ON.
2. If linkage would place the radio on the frequency stored in Memory Channel 2.
3. When operating on one of the Split Memory Channels (Memory Channels 8 and 9).
4. During full duplex operations.
5. During reverse operations.

4-7-9. Call Sign Entry

Automatic transmitter identification is possible when the CD-10 Call Sign Display is attached to the external speaker jack of the transceiver. Whenever a DCL signal is received the call sign of the station will appear in the CD-10 display.

Call signs are entered using Decimal ASCII codes. See the chart below.

ASCII call sign data

A : 65	B : 66	C : 67	D : 68
E : 69	F : 70	G : 71	H : 72
I : 73	J : 74	K : 75	L : 76
M : 77	N : 78	O : 79	P : 80
Q : 81	R : 82	S : 83	T : 84
U : 85	V : 86	W : 87	X : 88
Y : 89	Z : 90	Space : 32	
0 : 48	1 : 49	2 : 50	3 : 51
4 : 52	5 : 53	6 : 54	7 : 55
8 : 56	9 : 57		

- Press the C. SQ key to advance to the next code memory channel that you wish to activate. Repeat step 3.

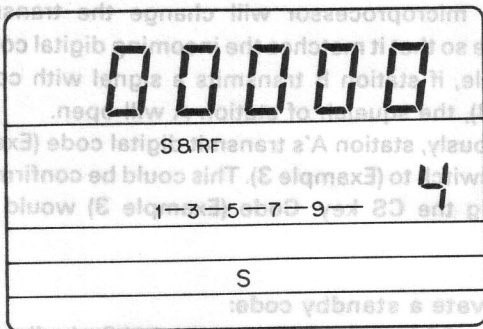

- Press the C. SQ key and advance until the desired transmitter code appears.

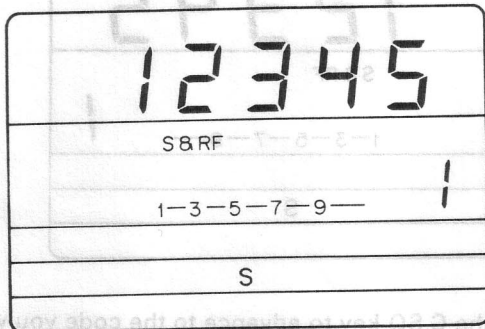

- Press the CS key to return to the normal receive frequency display.

4-7-6. Code Squelch

This function gives the operator the ability to select which stations he or she wants to listen to. Only those stations that transmit the proper access code will be able to open the squelch. Section 4-7-5 details the programming of the Digital Access Codes, and the Standby Indicator.

Digital Code Squelch Operation.

- To activate the Digital Squelch function press the C.SQ key. The C.SQ indicator will turn on. Code selection is discussed in Section 4-7-5.
- When the proper code is received the squelch will open, and the C.SQ indicator will turn OFF.
- If you want to again activate the C.SQ press the C.SQ key.
- C.SQ may be canceled by:
 - Turning the DCL system OFF.
 - Pressing the PTT switch.
 - Pressing the C.SQ key when the C.SQ indicator is ON.
- To open the squelch of a distant station(s) using code squelch:
 - Select the proper transmit code. See section 4-7-5.
 - Ensure the DCL indicator is ON.
 - Press the PTT switch.

4-7-7. Channel Linkage

The channel linkage feature allows you to shift from the present frequency to the first available open channel by a single touch of the key when there is interference between communication channels.

When the CHL key is pressed, the following operations take place in sequence (This is called the Channel Linkage operation.):

Channel linkage operation

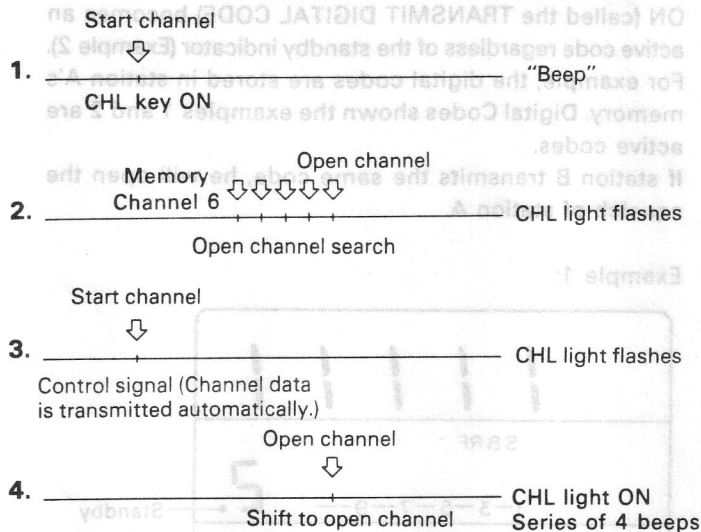

- The frequency displayed when the CHL key is pressed is stored in memory as the start channel.
- A search for an open channel begins.
- The start channel is recalled. The data (Control signal) including the open channel frequency is transmitted (Requires approximately 0.2 seconds).
- Control is passed to the open channel.

A channel linkage operation can begin from any frequency within the band.

Open channel search range

An open channel search operation will search up to 11 channels from the frequency stored in memory channel 6. (A total of 12 channels). Store the start frequency in channel 6.

Open channel search proceeds in steps according to the table shown below.

Model		Band	Freq. Step
TW-4100A	U.S.A. and Canada versions	144 MHz	15 kHz *
		440 MHz	25 kHz
	Other markets version	144 MHz	15 kHz *
TW-4100E		144 MHz	25 kHz
		430 MHz	

Notes:

- The frequency stored in Memory Channel 7 will be skipped even if it is within the open channel scan range.
- * Step size can be altered to 20 kHz if desired. (See page 28.) (TW-4100A only)

4. Standby Indicator (Code Activation)

The standby indicator is a visual indication of which digital access codes will actually open the squelch on the radio. Simply stated it shows the "Active" codes. When the indicator is ON the code is active, when the indicator is OFF the code is not active, and is ignored. Examples 1 and 3 show the example code with the standby indicator ON (active).

The code that is displayed when the CS key is pressed ON (called the TRANSMIT DIGITAL CODE) becomes an active code regardless of the standby indicator (Example 2). For example, the digital codes are stored in station A's memory. Digital Codes shown the examples 1 and 2 are active codes.

If station B transmits the same code, he will open the squelch of station A.

Example 1:

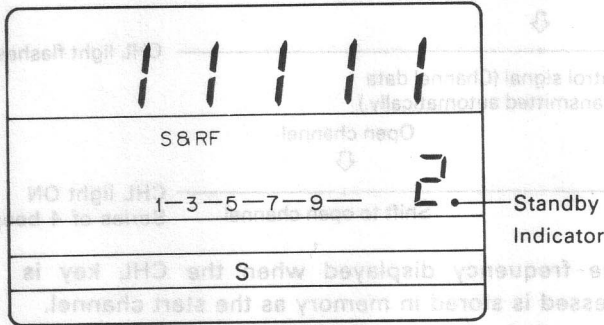

Example 2:

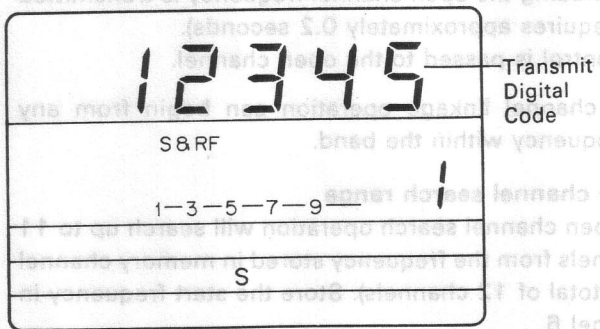

Example 3:



When station A receives one of the active digital codes, the microprocessor will determine if the received code matches the current transmit code. If the codes do not match the microprocessor will change the transmit digital code so that it matches the incoming digital code. For example, if station B transmits a signal with code (Example 3), the squelch of station A will open. Simultaneously, station A's transmit digital code (Example 2) will switch to (Example 3). This could be confirmed by pressing the CS key. Code (Example 3) would be displayed.

5. To activate a standby code:

1. Press the CS key to turn ON the Digital Code display.



2. Press the C.SQ key to advance to the code you wish to monitor, for example channel 3 (Digital Access Code: 24680).



3. Press the MHz key. A decimal point will appear in the code display.



4-7.5. Digital Access Code Entry

1. General

The DCL system operates between two or more transceivers, as long as all stations are using the same access code. It is therefore very important that all stations use the same code, or Channel Linkage/Digital Squelch operations will not function properly. Each digital access code is a 5 digit number. This provides 100,000 possible combinations. (00000-99999)

The TW-4100A/4100E provides 5 DCL memory positions to store these code groups. Any or all of which may be used for receive at the same time, but only one will be used for transmission.

The microprocessor controls which of the codes is used during transmission when listening for more than one code. For example, the microprocessor determines if an incoming code is one of the codes it has been instructed to listen for. If it is, the microprocessor determines if it matches the current transmit code. If the codes are different the microprocessor switches the transmit code to match the incoming code. If this did not occur you would not be able to open the squelch of the distant station.

2. Digital Access Code Entry

Example:

Store the following digital codes;
12345..... Digital Code Channel 1
24680..... Digital Code Channel 3

1. Press the CS key. The display will indicate a digital code. The Digital Code Channel Number display will indicate which access code is being displayed (1 to 5). See the example below.
2. The chart below illustrates the relationship of the front panel keys to their corresponding access code digits. All examples assume that the code memory positions currently contain 00000.

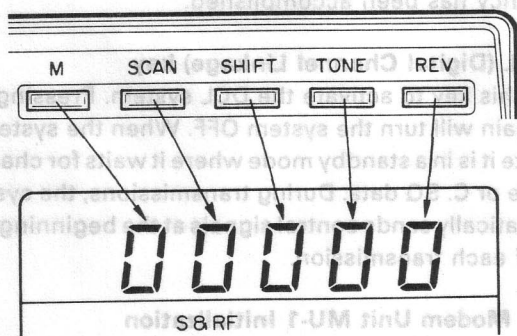

To store the first example code, (12345), press the M key one time. Press the SCAN key two times, the SHIFT key three times, the TONE key four times and the REV key five times.



3. Press the C. SQ key 2 times to advance to DCL memory position 3. (Channel 1 + 2)

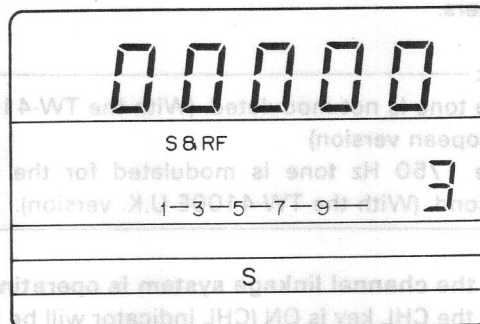

4. Store the second example code by pressing the M key 2 times, the SCAN key 4 times, the SHIFT key 6 times, the TONE key 8 times. Press the REV key until 0 appears in that position. Each time the M, SCAN, SHIFT, TONE and REV keys are depressed the corresponding digit increments by one. Therefore by watching the Digital Code display and pressing these keys you can select any of the desired codes.

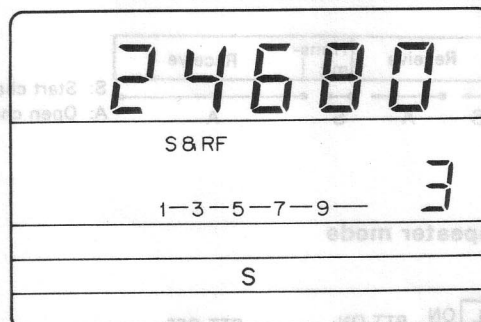

5. Once you have completed programming the Digital Access Codes press the CS key to return to the normal transmit/receive frequency display.

3. Transmit Digital Code

The digital code that appears when the CS key is pressed to return to the normal transmit/receive display in the above procedure will be the Transmit Digital Code.

(b) Repeater mode

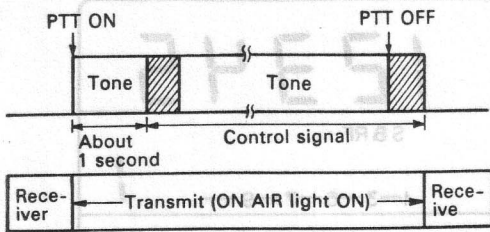

When the SHIFT key is ON, the control signal is transmitted about 1 second after the PTT switch is activated. This delay prevents the control signal from being broken by the slow response of some repeaters.

Notes:

1. The tone is not modulated. (With the TW-4100E European version)
2. The 1750 Hz tone is modulated for the first second. (With the TW-4100E U.K. version).

2. When the channel linkage system is operating:
 [When the CHL key is ON (CHL indicator will be ON), the control signal will be automatically transmitted for about 0.2 seconds.]

(a) Simplex mode

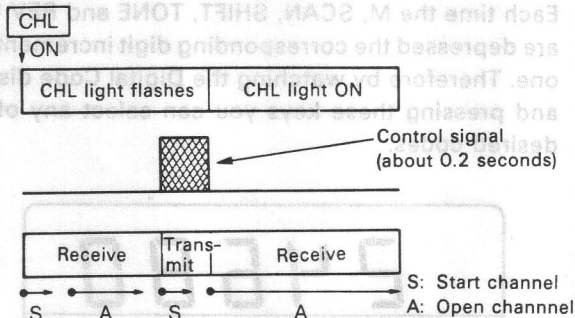

(b) Repeater mode

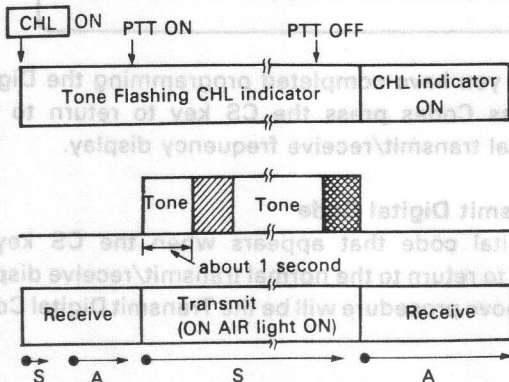

4-7-3. DCL System Keyboard

Remove the cap indicating DCL SYSTEM on the front panel.

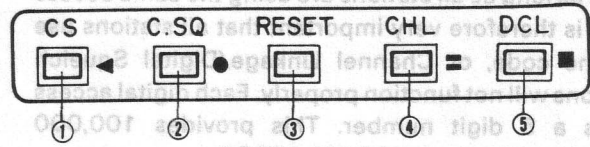

① CS (Code Set) key

This key is used to enter the digital access code and call sign into DCL memory. Pressing the key switches the display between the access code display and the normal transmit receive frequency display.

② C. SQ (Code Squelch) key

This key is used to activate the Digital Code Squelch function.

When the Digital Code is displayed, pressing this key selects the Digital Code Channel. This key is also used when programming the call sign data during call sign entry operation.

③ RESET key

Pressing this key after completing the channel linkage will turn the CHL indicator OFF and allow you to search for another open channel. Pressing the key again will initiate the reverse function, where the radio returns to the original operating frequency. This is useful if the channel linkage has failed for any reason. Pressing this key while entering or reviewing digital access code data will toggle the display between the access code data and call sign data.

④ CHL (Channel Linkage) key

Pressing this key while the system is active will initiate the channel linkage function. The CHL indicator will flash during the open channel search operation, and light continuously after channel linkage on the new frequency has been accomplished.

⑤ DCL (Digital Channel Linkage) key

Press this key to activate the DCL system. Pressing the key again will turn the system OFF. When the system is activate it is in a standby mode where it waits for channel linkage or C. SQ data. During transmissions, the system automatically sends control signals at the beginning and end of each transmission.

4-7-4. Modem Unit MU-1 Initialization

When the Modem Unit is first installed or the microprocessor has been reset, perform the following procedure. The Modem Unit is not recognized until this procedure is performed.

1. Turn the POWER switch OFF.
2. Press and hold the DCL key.
3. Turn the POWER switch ON.
4. Release the DCL key.

AUDIO TONES

High Tone (Hz) Low Tone (Hz)	1209	1336	1477	1633
697	1	2	3	A
770	4	5	6	B
852	7	8	9	C
941	*	0	#	D

To use the DTMF pad you should first key the radio using the PTT switch. Then simply press the numbers corresponding to the telephone number you want to dial. Some repeaters will require a special sequence of keys to activate the autopatch function.

After you have pressed the first number key the radio will remain keyed for approximately 2 seconds. This is done so you do not have to hold the PTT switch depressed while dialing. The radio remains keyed after you press each number for this 2 second interval.

4-7. DCL (Digital Channel Link) SYSTEM

4-7-1. DCL System Description

(The optional MU-1 Modem Unit is required for DCL system operation).

The DCL system provides a convenient automatic method of OSY'ing to an open simplex channel. The system is microprocessor controlled for speed and reliability, and offers several original features not previously available in amateur radio.

DCL System features

- The DCL system searches, on command, for an open channel, remembers the frequency, returns to the original operating frequency and transmits control information to the receiving station that switches both radios to the open channel. Microprocessor control assures fast and reliable operation of the DCL system.
- The recall and reverse functions are provided to ensure communications are not lost if the channel linkage operation fails for any reason.
- Digital code squelch operations are provided that utilize a five digit access code, and may be used in conjunction with the DCL feature. Five DCS memory positions are provided. The transceiver can use any or all of the code memories if desired.
- Squelch will open only when the transmitting station, and the receiving stations codes match.
- Automatic transmission and display of call sign data. (Display of call sign data requires the use of the CD-10 Call Sign Display). Up to 6 characters can be input for automatic transmission when the DCL system is turned on.

Note:

The DCL system operates only when the optional MU-1 Modem Unit is attached. When the system is operated without the MU-1, data (Control Signals) will not be exchanged with the distant station although the keys on the system operate.

4-7-2. Control Signal

The DCL system operates by transmitting a control signal that contains call sign data, digital access code information, and open channel control information.

This signal is transmitted under the following conditions:

- The PTT switch is pressed and released when the DCL light is ON.
- The OPEN channel data is sent to the distant station during a channel linkage operations.

Code squelch control signal
(Without open channel data)

Channel linkage control signal
(With open channel data)

1. When the DCL system is operating:

[When the DCL key is ON (DCL light ON), the control signal is sent for about 0.2 seconds at the beginning and end of each transmission.]

(a) Simplex mode

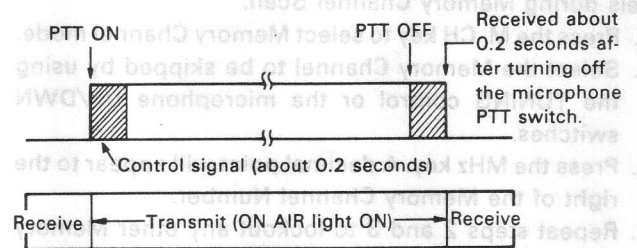

Microphone is muted.

Don't start talking after a short delay to allow the DCL/DCS control signal to be transmitted without interference.

4-5. SCAN

Basic Scan Operations

- (1) Scan will stop whenever the squelch opens, and the BUSY indicator appears in the display. For proper scan operation the squelch must be adjusted to the threshold point.
- (2) Scan in progress indicator.
The MHz dot will flash OFF and ON as a visual reminder that the radio is scanning.
- (3) Scan direction
Scan will begin in an upwards direction. You can reverse the direction by rotating the TUNING control counterclockwise, or by pressing the microphone DWN switch.

4-5-1. Band Scan

When operating in the VFO mode pressing the SCAN key will initiate Band Scan. When the STEP indicator is ON the radio scans in 1 MHz steps. This allows rapid changes from 2 meters to 70 cm. When the STEP indicator is OFF the radio will scan within the current band. The step size is determined by the current STEP programming. (See section 4-2-7.)

4-5-2. Memory Channel Scan

If the SCAN key is pressed while the M CH indicator is ON, Memory Channel Scan will begin.

4-5-3. Memory Channel Lockout

This transceiver has a scan lockout function which allows you to temporarily skip unwanted Memory Channels during Memory Channel Scan.

1. Press the M. CH key to select Memory Channel mode.
2. Select the Memory Channel to be skipped by using the TUNING control or the microphone UP/DWN switches.
3. Press the MHz key. A decimal point will appear to the right of the Memory Channel Number.
4. Repeat steps 2 and 3 to lockout any other Memory Channels that you want to skip.

To cancel the lockout, select the desired Memory Channel as described in steps 2 and 3 above. Press the MHz key, the decimal point will go out. The Memory Channel will now be scanned normally.

4-5-4. Scan Release

Scan may be cleared by pressing any of the following keys or turning the POWER switch off.

- SCAN key
- PTT switch

4-5-5. Scan Hold

- (1) Scan will stop whenever a signal is received that activates the BUSY indicator.
- (2) Scan will resume approximately 6 seconds after the BUSY indicator turns ON (Time operated Scan).
- (3) You can cause scan to resume during this delay if the TUNING control or the UP/DWN switches on the microphone are depressed.

4-6. REPEATER

4-6-1. Transmitter Offsets

All amateur radio repeaters utilize a separate receiver and transmitter section. The receiver frequency may be either above or below the transmitter frequency. For most repeaters this offset is ± 600 kHz for 2 meters and ± 5 MHz with the TW-4100A (± 1.6 MHz with the TW-4100E) for 70 cm. The TW-4100A/4100E allows you to store the frequency, offset direction, and the amount of the offset in memory.

4-6-2. Reverse Function

Some repeaters utilize a "Reverse pair", i.e. the transmit/receive frequencies are exactly the reverse of another repeater. For example repeater A uses 146.000 for a transmit frequency (OUTPUT) and 146.600 for receive (INPUT). Repeater B uses 146.000 for its receive and 146.600 for its transmit frequency. It would be inconvenient to have to reprogram the radio each time if you were in range of both repeaters.

The REV key has been provided to allow you to reverse the transmit and receive frequencies. To use the REVERSE function press the REV key. The REV indicator will light in the display to remind you that you are working a reverse repeater pair.

To return to normal offsets press the REV key again. This function is also useful to check the input frequency of the repeater, so that you can determine if you are within SIMPLEX communications range.

4-6-3. Tone Operations

Some repeaters require the use of a control signal to activate the repeater. Several versions are currently in use worldwide.

In Europe a 1750 Hz tone is used in transmit. In the United Kingdom a 1750 Hz tone burst at the beginning of each transmission is used. In the United States tones are sometimes used. Since use of these tones is required in the United Kingdom and in Europe, an 1750 Hz tone encoder is included as standard equipment. In the United States 38 different tone frequency selections are possible. (See section 4-2-6. Tone Frequency Selection.)

Notes:

1. The TONE key will not function if you are already in transmit.
2. Pressing the PTT switch while the TONE key is depressed causes the 1750 Hz tone to be generated. The tone will continue as long as the PTT switch is held depressed. (European version only)

4-6-4. Autopatch Operations (with MC-48B Microphone)

Some repeaters offer a service known as AUTOPATCH. This allows you to dial a telephone number from your radio and carry out a telephone conversation, much like a car telephone, or cellular telephone. This function requires the use of a DTMF (Dual Tone Multi Frequency) pad. In addition to the normal 12 keys that are found on your telephone the MC-48B microphone also provides 4 additional keys, A, B, C, and D. These keys are required by some repeater systems for various control functions. You should check with the control operator of your repeater to determine if their use is required. A chart is provided that lists the tones that are generated when you press each key.

4-4. MEMORY

4-4-1. Microprocessor Memory Backup

A lithium battery is contained in the transceiver to retain memory. Turning off the POWER switch, disconnecting the power cable, or a power failure will not erase the memory. The battery should last for approximately five years. When the battery discharges, an erroneous display may appear in the display.

(For the lithium battery replacement, refer to section 5-5.)

4-4-2. Initial State and Reset of the Microprocessor.

A. Initial state of the microprocessor from the factory.

Model	TW-4100A	TW-4100E	
VFO Frequency	145.000 MHz		
Memory Channel	Memory Channel 0		
All Memory Channel Frequency	145.000 MHz		
Shift (Offset)	_____		
Tone frequency	67.0 Hz *	_____	
Frequency step	144 MHz (L)	5 kHz	12.5 kHz
	430/440 MHz (H)	25 kHz	
Transmitter offset frequency	144 MHz (L)	0.6 MHz	
	430/440 MHz (H)	5.0 MHz	1.6 MHz

Note (TW-4100A only): _____

* : When no Tone unit is connected, pushing the TONE key does not send out tone signals, although tone frequency is displayed.

B. Microprocessor initialization

To erase all data from the memory or reset the microprocessor, you may initialize the microprocessor from the front panel as follows:

1. Turn the POWER switch off.
2. Turn the POWER switch on while pressing the M key.
3. Release the M key.

4-4-3. Memory Channels

The TW-4100A/4100E provides 10 memory channels (0 thru 9). In addition to serving as a normal memory channel some of the memory channels serve a dual purpose to specify other parameters.

- Memory Channels 8 and 9 are used for storing odd split repeater channels (See section 4-4-4).
- Memory Channel 2 is a protected channel that ignores channel linkage control signals even when the access codes match. This is a limitation only when the DCL system is active.
- Memory Channel 7 is excluded from open channel search, during DCL operations.

4-4-4. Memory Operations

(1) The following data can be stored in each memory channel:

MODEL CHANNEL	TW-4100A	TW-4100E	
		European version	U.K. version
Memory Channels 0 ~ 7	Frequency data OFFSET ON/OFF OFFSET + - TONE ON, OFF Tone frequency data	Frequency data OFFSET ON/OFF OFFSET + -	Frequency data OFFSET ON/OFF OFFSET + - TONE ON, OFF
Memory Channels 8 and 9	Frequency data Transmit frequency data TONE ON, OFF Tone frequency data	Frequency data Transmit frequency data	Frequency data Transmit frequency data TONE ON, OFF

(2) Memory Data Entry

SIMPLEX/NORMAL OFFSET (Memory Channels 0 thru 7)

1. Select the desired operating frequency, offset, etc., using the methods previously discussed.
2. Press the VFO/M.CH key to select the Memory Channel mode.
3. Rotate the TUNING control until the desired Memory Channel Number appears in the display.
4. Press the VFO/M.CH key to return to the VFO mode.
5. Press the M key. A long beep will sound to confirm data entry.
6. The above will program new or replace existing memory data.

ODD SPLIT CHANNELS (Memory Channels 8 and 9)

1. Select the desired receiver frequency, tone frequency (TW-4100A only), tone ON/OFF (except for the TW-4100E European version), etc.
2. Press the VFO/M. CH key to select the M. CH mode.
3. Rotate the TUNING control to select Memory Channel 8 or 9.
4. Press the VFO/M. CH key to select VFO mode.
5. Press the M key. A long beep will sound to confirm that the receiver data has been stored, followed by 4 short beeps that sound continuously.
6. Select the desired transmitter frequency using the TUNING control or the microphone UP/DWN switches. When using as an ordinary Memory Channel, select the same frequency as the receiving frequency.
7. Press the M key. A long beep will sound to confirm data entry.
8. The above will program new or replace existing memory data.

Note: _____

When entering data into the Split Memory Channels (8 and 9), the 4 beeps will continue to sound even if the power is switched OFF and ON again. The beeps will not stop until you press the M key to store the transmit data.

4-4-5. Transferring Memory Channel Data to the VFO

To transfer data from a Memory Channel to the VFO press the M key while the M CH indicator is ON. This will transfer the data to the VFO, and allow you to begin tuning from that point. Data in the memory is not lost. It has just been duplicated in the VFO.

B. 70 cm Band

The 70 cm band offset selection may be programmed just like the 2 meter band. The standard transmitter offsets are the same as for the 2 meter band. To program the 70 cm band offset:

1. Select the VFO (or the Memory Channel) mode.
2. Press the SEL key 6 times (5 times with TW-4100E).

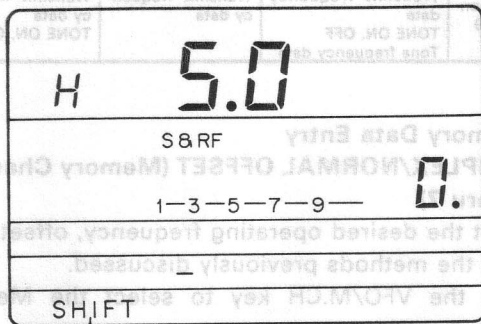

SHIFT indicator flashes

3. Rotate the TUNING control clockwise to select the desired offset. The display will indicate the selection. The initial setting from the factory is 5.0 MHz (1.6 MHz with the TW-4100E).
4. Press the SEL key 1 time to return to the VFO/Memory Channel mode.

4-3. TRANSMISSION

Caution:

Ensure that an antenna with a low standing wave ratio (SWR) is attached to the antenna connector before attempting to transmit. Failure to provide proper termination may result in damage to the final amplifier section.

Always check to ensure the frequency is clear before transmitting.

Notes:

1. The use of LOW power is recommended, whenever possible, to avoid interfering with other stations.
2. If the radio has been used in the transmit mode for an extended period of time the protection circuit may activate due to high internal temperatures. When this occurs the power will be reduced to the low power setting until the internal temperature falls to a safe level. Ensure the radio is installed so that it receives adequate ventilation.

4-3-1. Transmit Basics

1. Select the desired operating frequency using any of the methods described above.
2. Check the frequency to see if it is occupied before you transmit.
3. Press the PTT switch. The ON AIR indicator will light, and the RF meter will deflect to the right.



4. Speak into the microphone. The recommended distance to the microphone is 2 inches (5 cm). Talking closer may result in overdeviation of your transmit signal, and talking too far away may result in reports of weak audio.
5. Release the PTT switch to return to the receive mode. The ON AIR indicator should go out, and the RF meter will return to zero.
6. If you have selected the LOW power position, the LOW indicator will appear in the display and the RF meter will only deflect slightly. When HI power has been selected the RF meter will swing full scale.

4-3-2. Duplex Operation

Where the memory channel frequency and the VFO frequency are in different frequency bands, duplex operation (simultaneous sending and receiving) is possible.

1. Press the VFO/M.CH key to select the Memory Channel mode.
2. Select the desired Memory Channel (transmit). (4-2-4. Frequency Selection)

Note:

Always check to ensure the frequency is clear before transmitting.

3. Press the VFO/M.CH key to return to VFO mode.
4. Select a desired receiving frequency in the other band than the band selected in step 2 above.
5. Select DUP as the shift direction.
6. Confirm that the radio is returned in the VFO mode.
7. Press the SHIFT key. (DUP indicator lights.)
8. Now, pushing the PTT switch on the microphone allows the simultaneous reception in the frequency and sending in a memory channel frequency.

Notes:

1. When Split Memory Channel 8 or 9 has been selected, that receiving frequency becomes the sending frequency.
2. Press the REV key reverses the transmit and receive frequencies.
3. With certain relationship between the sending and receiving frequencies, the receiver sensitivity may be suppressed.

3. Rotate the TUNING control clockwise to select the desired tone frequency. The display will indicate the selected frequency. Rotating the TUNING control counterclockwise will not change the frequency.
- 4.A. Press the SEL key 5 times to return to the VFO/Memory Channel modes.
- B. Press the SEL key 1 time to advance to the 2 meter band Step Frequency selection.

Available CTCSS Tone Frequencies

Hz	Hz	Hz
67.0	114.8	192.8
71.9	118.8	203.5
74.4	123.0	210.7
77.0	127.3	218.1
79.7	131.8	225.7
82.5	136.5	233.6
85.4	141.3	241.8
88.5	146.2	250.3
91.5	151.4	
94.8	156.7	
97.4	162.2	
100.0	167.9	
103.5	173.8	
107.2	179.9	
110.9	186.2	

4-2-7. Frequency Step Selection

A. 2 Meter Band

The 2 meter (L) can be programmed to any of 6 different frequency steps (05, 10, 12.5, 20, 25, or 50 kHz). To select the desired frequency step:

1. Select the VFO (or the Memory Channel) mode.
2. Press the SEL key 3 times (2 times with TW-4100E).

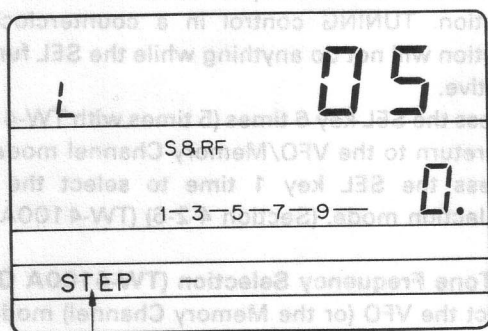

STEP indicator flashes

3. Turn the TUNING control clockwise to select the desired frequency step. The radio will increment one division for each click of the TUNING control.
- 4.A. Press the SEL key 4 times to return to the VFO/Memory Channel mode.
- B. Press the SEL key 1 time to advance to the 70 cm band Step Frequency selection.

B. 70 cm Band

1. Select the VFO (or the Memory Channel) mode.
2. Press the SEL key 4 times (3 times with TW-4100E).

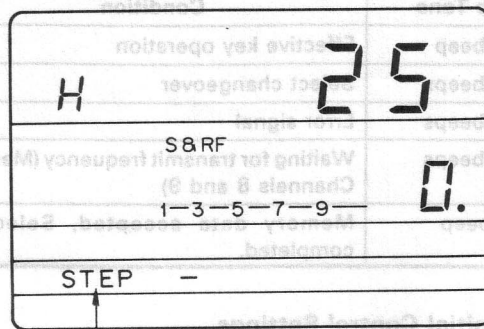

STEP indicator flashes

3. Turn the TUNING control clockwise to select the desired frequency step.
- 4.A. Press the SEL key 3 times to return to the VFO/Memory Channel mode.
- B. Press the SEL key 1 time to advance to the transmitter offset frequency.

4-2-8. Transmitter Offset Frequency Selection

A. 2 Meter Band

The following standard offsets are available for the 2 meter band; 0.0 (Simplex), 0.6 MHz, 1.6 MHz, 5.0 MHz, and 7.6 MHz. The following procedure describes how to select the desired offset:

1. Select the VFO (or the Memory Channel) mode.
2. Press the SEL key 5 times (4 times with TW-4100E).

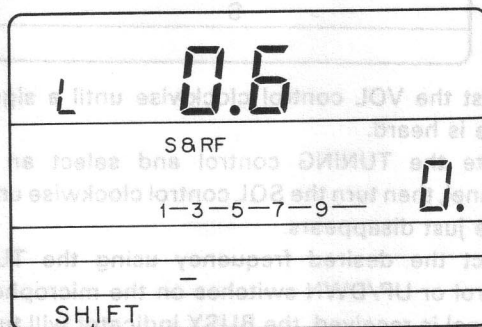

SHIFT indicator flashes

3. Rotate the TUNING control clockwise to select the desired offset. The display will indicate the selection. The initial setting from the factory is 0.6.
- 4.A. Press the SEL key 2 times to return to the VFO/Memory Channel mode.
- B. Press the SEL key 1 time to program the 70 cm band offset.

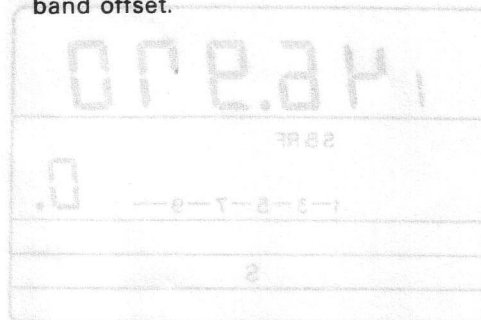

4.2. RECEPTION

4-2-1. Beep Tones

Beep Tone	Condition
1 short beep	Effective key operation
2 short beeps	Select changeover
3 short beeps	Error signal
4 short beeps	Waiting for transmit frequency (Memory Channels 8 and 9)
1 long beep	Memory data accepted, Selection completed.

4-2-2. Initial Control Settings

Connect the power supply and the antennas then set the control and switches as follows:

VOL/POWER control: Fully counterclockwise

SQL control : Fully counterclockwise

4-2-3. Reception

1. Turn the power switch ON.

(If the display is not similar to the display shown below you should reset the microprocessor. Refer to the Section 4-4-2-B.

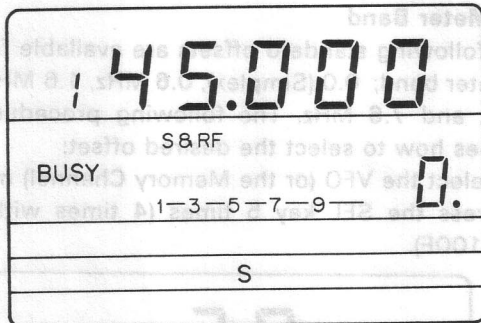

2. Adjust the VOL control clockwise until a signal or noise is heard.
3. Rotate the TUNING control and select an open channel, then turn the SQL control clockwise until the noise just disappears.
4. Select the desired frequency using the TUNING control or UP/DWN switches on the microphone. If a signal is received, the BUSY indicator will turn ON and the S-meter will deflect.

4-2-4. Frequency Selection

1. VFO mode

To select the desired operating frequency in the VFO mode rotate the TUNING control or use the microphone UP/DWN switches.

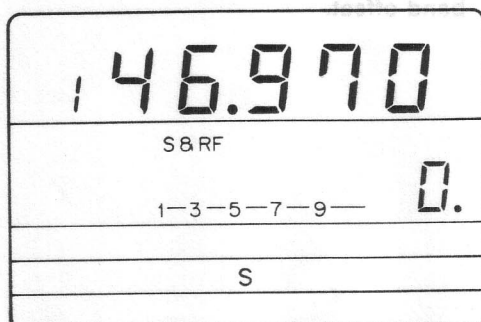

2. M.CH (Memory Channel) mode

The desired Memory Channel can be selected using the same controls. To select a Memory Channel first press the VFO/M.CH key to select the Memory Channel mode. Rotate the TUNING control or the microphone UP/DWN switches to select the desired Memory Channel.



4-2-5. Shift (Offset) Selection

1. Select the VFO (or the Memory Channel) mode.
2. Press the SEL key 1 time.
3. Rotate the TUNING control clockwise to select the desired transmitter offset direction. Rotating the control will advance from "-" to "+" to "DUP" (Duplex) back to "-" and so on.

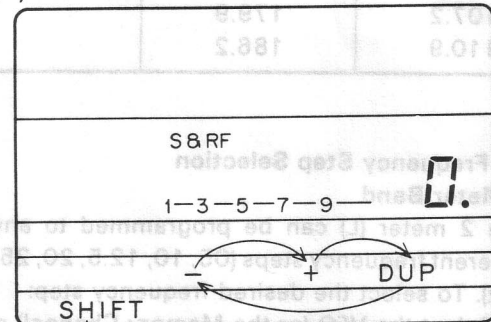

SHIFT indicator flashes

4. The TUNING control only functions in the clockwise direction. TUNING control in a counterclockwise direction will not do anything while the SEL function is active.
- 5.A. Press the SEL key 6 times (5 times with TW-4100E) to return to the VFO/Memory Channel modes.
- B. Press the SEL key 1 time to select the Tone Selection mode. (Section 4-2-6) (TW-4100A only)

4-2-6. Tone Frequency Selection (TW-4100A Only)

1. Select the VFO (or the Memory Channel) mode.
2. Press the SEL key 2 times.

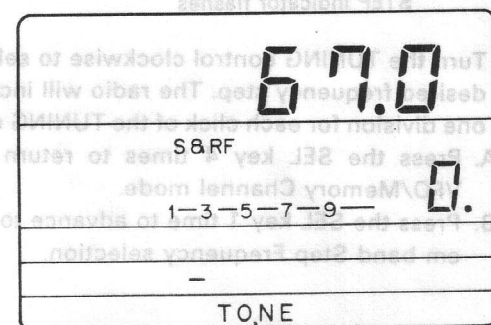

TONE indicator flashes

4-1-2. Rear Panel

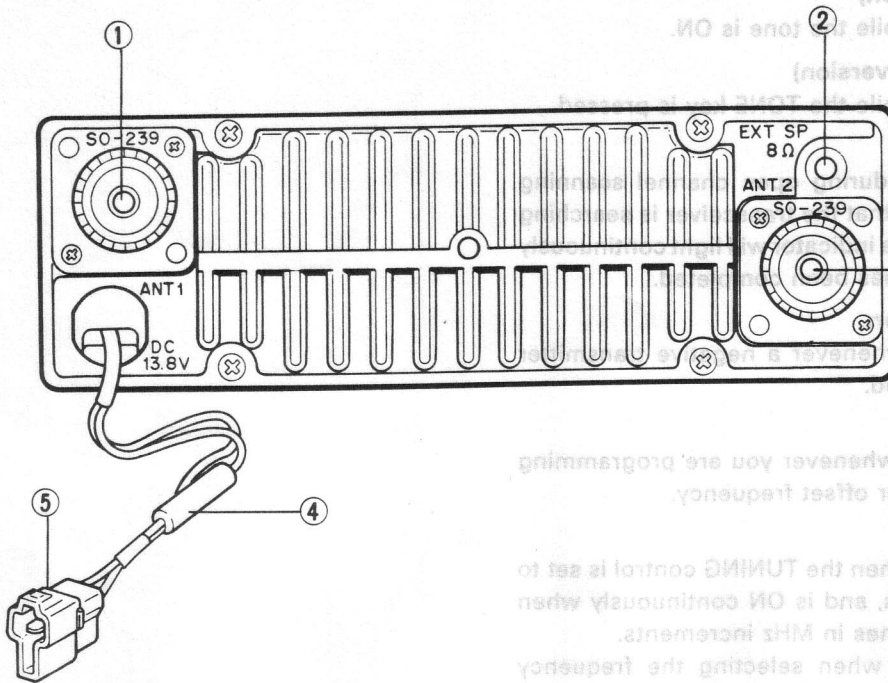

① ANT 1 (Antenna 1) jack

This antenna jack is used for the 2 meter band. It has an impedance of 50 ohms (unbalanced) and requires an M type connector (PL-259).

② EXT.SP (External Speaker) jack

Connect a speaker with an impedance of 8 ohms.

③ ANT 2 (Antenna 2) jack

This antenna jack is used for the 70 cm band. It has an impedance of 50 ohms (unbalanced) and requires an M type connector (PL-259). (N type connector with the TW-4100E.)

④ Fuse Holder

Contains a 10A fuse.

⑤ 13.8VDC Power Supply jack

Connect the supplied DC power cable to this connector. Pay close attention to the polarity (The DC power cable is color-coded; red is positive and black is negative), when connecting the cable to the DC power source.

4-1-3. Microhone

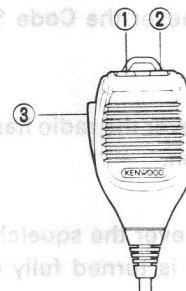

(TW-4100A U.S.A. version only)

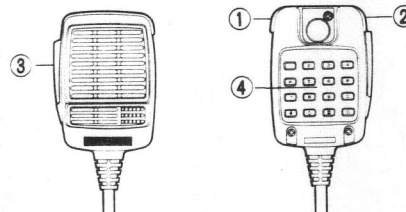

① ② UP/DWN (Up/Down) switches

These switches are used to step the VFO frequency or memory channel up and down. The frequency will change continuously if the switches are pressed and held.

③ PTT (Push To Talk) switch

The transceiver will be placed into Transmit whenever this switch is pressed. Operations such as scanning, code squelch operations, and channel linkage will be cleared when this switch is pressed.

④ 16 Touch-Tone key (TW-4100A U.S.A. version only)

Used to activate the touch-tone encoder. (Autopatch operation)

(TW-4100E U.K. version)

This indicator lights while the tone is ON.

(TW-4100E European version)

This indicator lights while the TONE key is pressed.

⑬ CHL indicator:

This indicator flashes during open channel scanning operations, to indicate that the transceiver is searching for an open channel. The indicator will light continuously after Channel linkage has been completed.

⑭ Minus “-” indicator:

This indicator is ON whenever a negative transmitter offset has been selected.

⑮ SHIFT indicator:

This indicator flashes whenever you are programming the offset or transmitter offset frequency.

⑯ STEP indicator:

This indicator is OFF when the TUNING control is set to tune in kHz increments, and is ON continuously when the TUNING control tunes in MHz increments. This indicator flashes when selecting the frequency step.

⑰ C. SQ indicator:

This indicator is ON whenever the Code Squelch function has been activated.

⑱ LOW indicator:

This indicator is ON whenever the radio has been placed in the LOW power position.

⑲ BUSY indicator:

This indicator is ON whenever the squelch opens, such as when the SQL control is turned fully counterclockwise.

⑳ ON AIR indicator:

This indicator is ON when the radio is in the transmit mode.

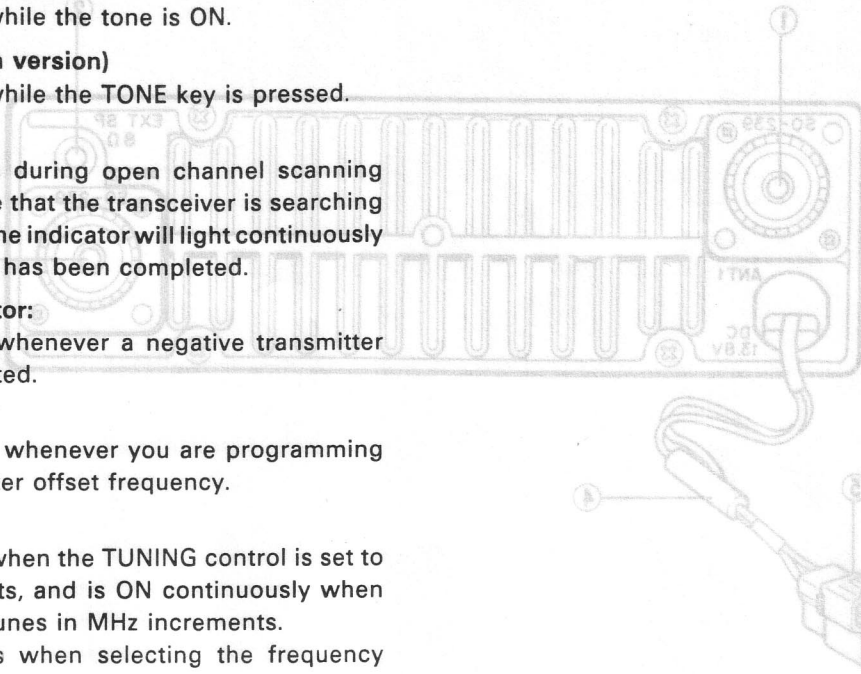

- ① ANT 1 (Antenna 1) jack
This antenna jack is used for the 2 meter band. It has an impedance of 50 ohms (unbalanced) and requires an M type connector (PL-259).
- ② EXT.SP (External Speaker) jack
Connect a speaker with an impedance of 8 ohms.
- ③ ANT 2 (Antenna 2) jack
This antenna jack is used for the 70 cm band. It has an impedance of 50 ohms (unbalanced) and requires an M type connector (PL-259). (N type connector with the TW-4100E).
- ④ Fuse Holder
Contains a 10A fuse.
- ⑤ 13.8VDC Power Supply jack
Connect the supplied DC power cable to this connector. Pay close attention to the polarity (The DC power cable is color-coded; red is positive and black is negative). When connecting the cable to the DC power source.



- ① UP/DWN (Up/Down) switches
These switches are used to step the VFO frequency or memory channel up and down. The frequency will change continuously if the switches are pressed and held.
- ② PTT (Push To Talk) switch
The transceiver will be placed into Transmit whenever this switch is pressed. Operations such as scanning, code squelch operations, and channel linkage will be cleared when this switch is pressed.
- ③ Touch-Tone key (TW-4100A U.S.A. version only)
Used to activate the touch-tone encoder (Autopatch operation).

11 MICROPHONE jack (8-pin)

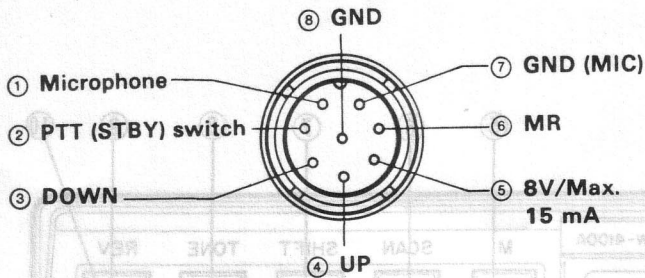

Plug the standard or optional microphone into this jack.

12 VOICE/SQL (Squelch) control

The SQL control is used to eliminate noise during no signal periods. Normally this control is adjusted clockwise until the noise just disappears, and the BUSY indicator goes OFF (Threshold level). For scan operations this control must be set to the threshold point. When an incoming signal is weak or unstable, readjust the SQL control for optimum reception.

To activate the VS-2 Voice Synthesizer unit press the VOICE/SQL control. Refer to section 4-8. VOICE SYNTHESIZER.

13 VOL (Volume)/POWER (On/Off)/HI/LOW control

Turn this control clockwise to turn the power ON. Press the control to switch between HI and LOW transmitter power. Turn the control clockwise to increase the volume and turn the control counterclockwise to decrease the volume.

Position	Model TW-4100A/4100E	
	2m band	70 cm band
HI	45 W	35 W
LOW	About 5 W	

14 TUNING control

Rotate this control clockwise to increase frequency and counterclockwise to decrease the transmit/receive frequency. This control is also used in conjunction with the SEL key to select the desired shift, tone frequency, step size and transmitter offset frequency. When used to select these parameters the control functions in the clockwise direction only!

Display panel

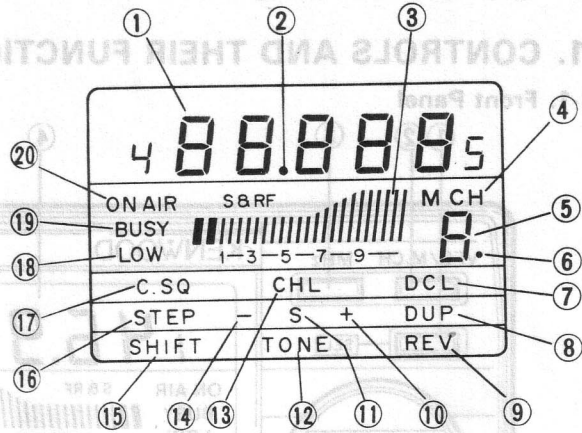

1 Frequency display:

Displays frequency, digital code and or call sign data. (Call signs are displayed as decimal ASCII values.)

2 MHz dot:

This indicator flashes during scan operations.

3 S & RF meter:

Indicates the relative receiver strength during receive, and functions as the relative transmit power indicator during transmit.

4 M CH indicator:

This indicator lights whenever you are in the Memory Channel mode.

5 Memory Channel Number indicator:

This section of the display is used to indicate the Memory Channel Number that is currently in use. During some DCL operations it is used to indicate the number of the digital code channel.

6 Standby indicator:

This indicator indicates the Memory Channel currently display will be skipped during Memory Channel scan. This indicator is also used to show which of the Digital Access codes is active. (See the Section 4-7. DCL SYSTEM.)

7 DCL indicator:

This indicator is ON whenever the DCL system is activate.

8 DUP indicator:

This indicator is ON during duplex operations.

9 REV indicator:

This indicator is used to show when the radio is operating on a reverse repeater pair. See the REPEATER section for additional information on this function.

10 Plus "+" indicator:

This indicator is ON whenever a positive transmitter offset has been selected.

11 "S" indicator:

This indicator is ON during simplex operations.

12 TONE indicator: (TW-4100A)

This indicator flashes when selecting the tone frequency, and is ON continuously when the Tone function has been selected.

4. OPERATION

4-1. CONTROLS AND THEIR FUNCTIONS

4-1-1. Front Panel

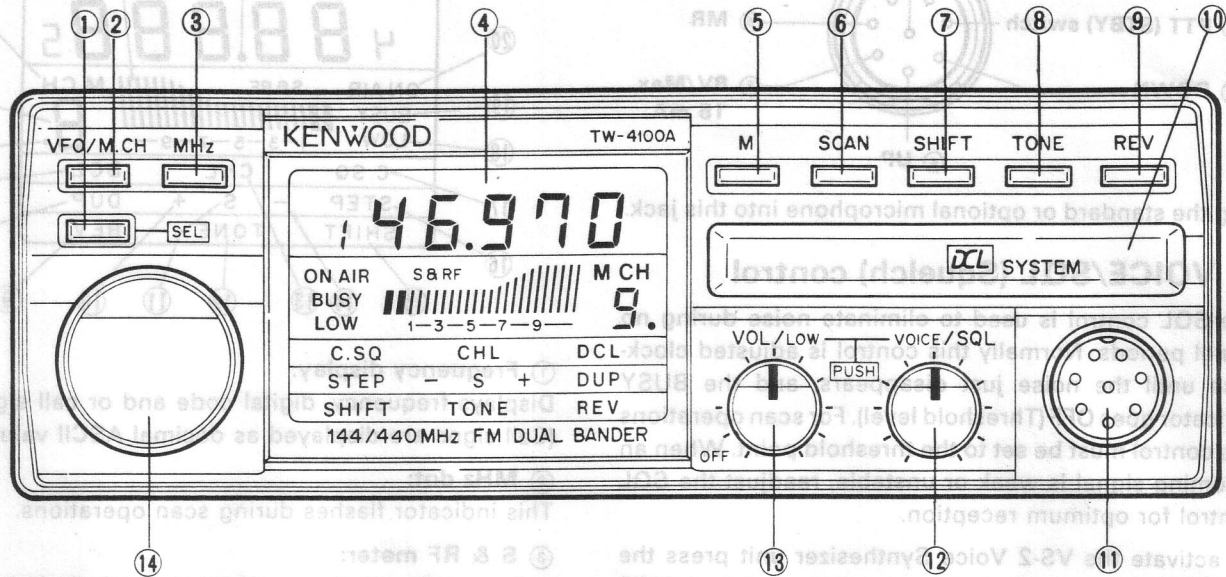

Note:
The display shown in the accompanying diagram is shown with all of the various indicators ON at the same time. This will never happen in normal use and is done for explanation purposes only.

① SEL (Select) key

This key is used to select the offset direction, tone frequency, step frequency and or the offset frequency. The TUNING control may be used to adjust the respective setting, after the desired function has been selected. (Refer to Sections 4-2-5 ~ 4-2-8.)

② VFO/M.CH key

This key is used to switch between the VFO and M.CH (Memory Channel) modes. Use the TUNING control to increase or decrease the frequency, or to select the desired Memory Channel.

③ MHz key

This key is used to select the tuning rate of the TUNING control. When the STEP indicator is lit, the TUNING control will cause the radio to increase or decrease in 1 MHz steps. This function is useful when you want to change from the 2 meter band to the 70 cm band.

This key is also used when programming the Memory Channel Scan and Standby Digital Code. (Refer to Sections 4-5. SCAN and 4-7-5. Digital Access Code Entry.)

④ Display panel

The transceiver frequency, Memory Channel Number, S & RF meter, and various other indicators are combined into this large easy to read LCD (Liquid Crystal Display). (See page 10.)

⑤ M (Memory) key

This key is used to enter a frequency, offset, etc. into the desired Memory Channel. The key is used during VFO operations only. When this key is pressed during Memory Channel operations the contents of the Memory Channel are transferred to the VFO, and then switches the set back to the VFO mode.

⑥ SCAN key

This key is used to turn the SCAN function ON or OFF.

⑦ SHIFT key

This key is used to select the desired transmitter offset.

⑧ TONE key

This key is used to turn the tone encoder ON or OFF. For the repeater operation, refer to the Section 4-6. REPEATER.

⑨ REV (Reverse) key

This key is used to reverse the transmit/receive frequencies during repeater operations. This will allow you to check the input of the repeater or to operate on a reverse repeater pair.

⑩ DCL System keys (under cover)

These keys are used to activate the DCL (Digital Channel Link) system. This system includes the C. SQ (Digital Code Squelch) function. (See page 19.)

Note:
The optional MU-1 Modem unit must be installed for this system to operate.

Caution:

Observe polarity of the cable. Battery polarity must be correct. The power cable is color coded:

Red → +(Positive) polarity

Black → -(Negative) polarity

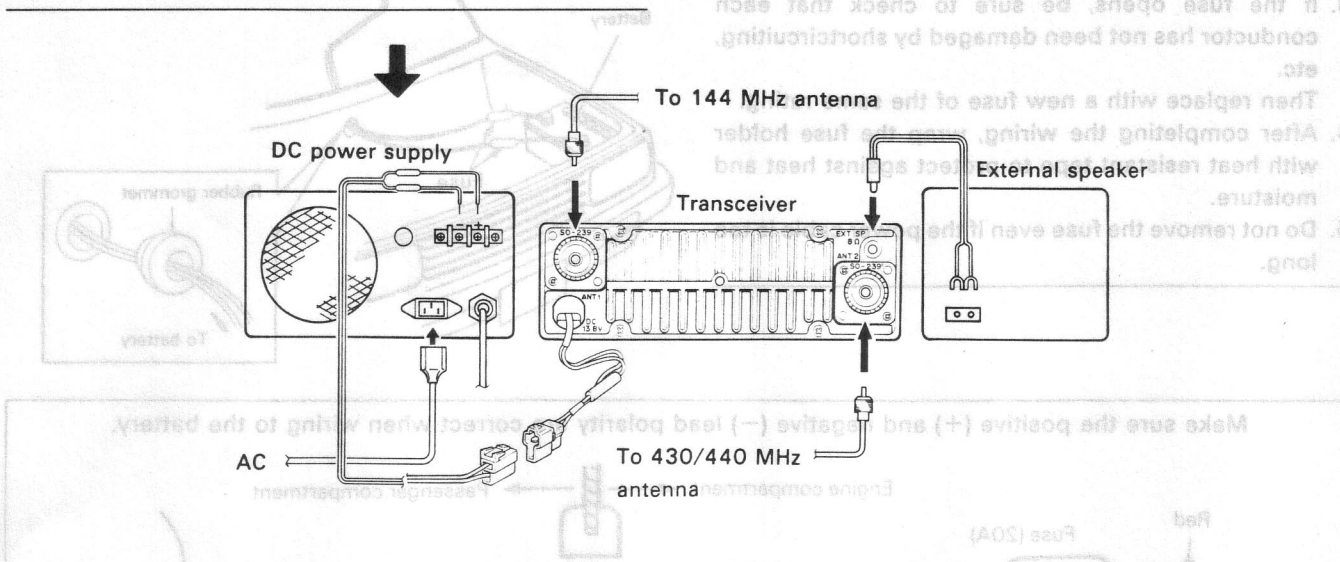

3-2-4. Antenna

The type of antenna that is used will greatly affect the performance of the transceiver. Use a properly adjusted antenna, of good quality, to enable your transceiver to perform at its best. The antenna input impedance for both bands is 50 ohms.

Use 50-ohm coaxial cable such as RG-8U or 8D-2V for this connection. If the antenna is far from the transceiver the use of low loss coaxial cable, such as RG-8U is recommended. Match the impedance of the coaxial cable and that of the antenna so that the SWR is less

than 1.5 to 1. The protection circuit in the transceiver will activate if the SWR is particularly poor (greater than 3 to 1). High SWR values will cause transmitter output to drop, and may lead to TVI or BCI reports.

Caution:

For protection against fire, electric shock, personal injury, or damage to the radio, use a lightning arrester in your antenna lines.

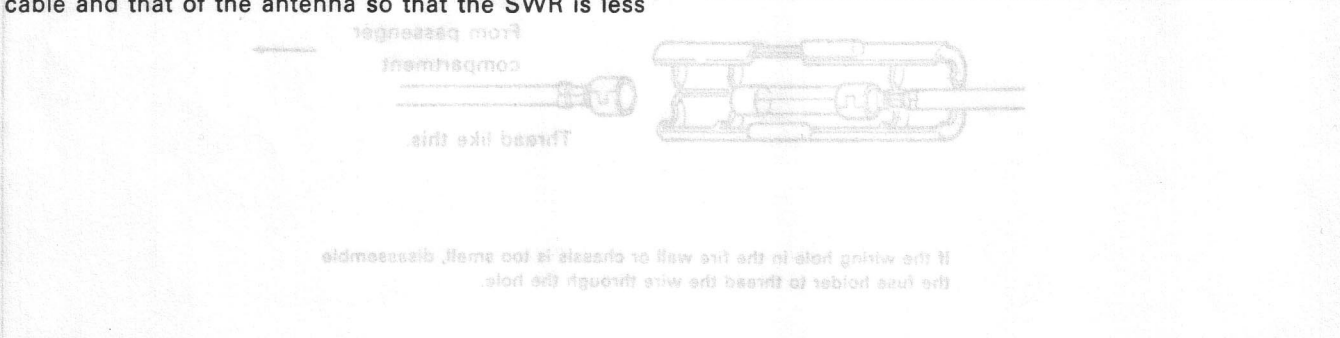

3-2-3. Fixed Station
Connect the transceiver to a regulated 13.8 VDC power supply only. The use of the PS-430 or the PS-50 is recommended.

Caution:

1. Never connect the AC cable to the AC outlet until all connections have been made.
2. Before connecting and disconnecting the power connector, be sure to turn off the power switches of both the transceiver and the DC power supply.

8. Ignition noise
This transceiver is designed to suppress ignition noise; however, if excessive noise is present, it may be necessary to use suppressor spark plugs (with resistors), or an external noise filter such as the PG-3B.

Notes:

1. Before installing the power cable, be sure to remove the negative lead from the battery for safety.
2. After installation and wiring, be sure to double check for correct installation before reconnecting the negative lead to the battery terminal.
3. If the fuse opens, be sure to check that each conductor has not been damaged by shortcircuiting, etc.
Then replace with a new fuse of the same rating.
4. After completing the wiring, wrap the fuse holder with heat resistant tape to protect against heat and moisture.
5. Do not remove the fuse even if the power cable is too long.

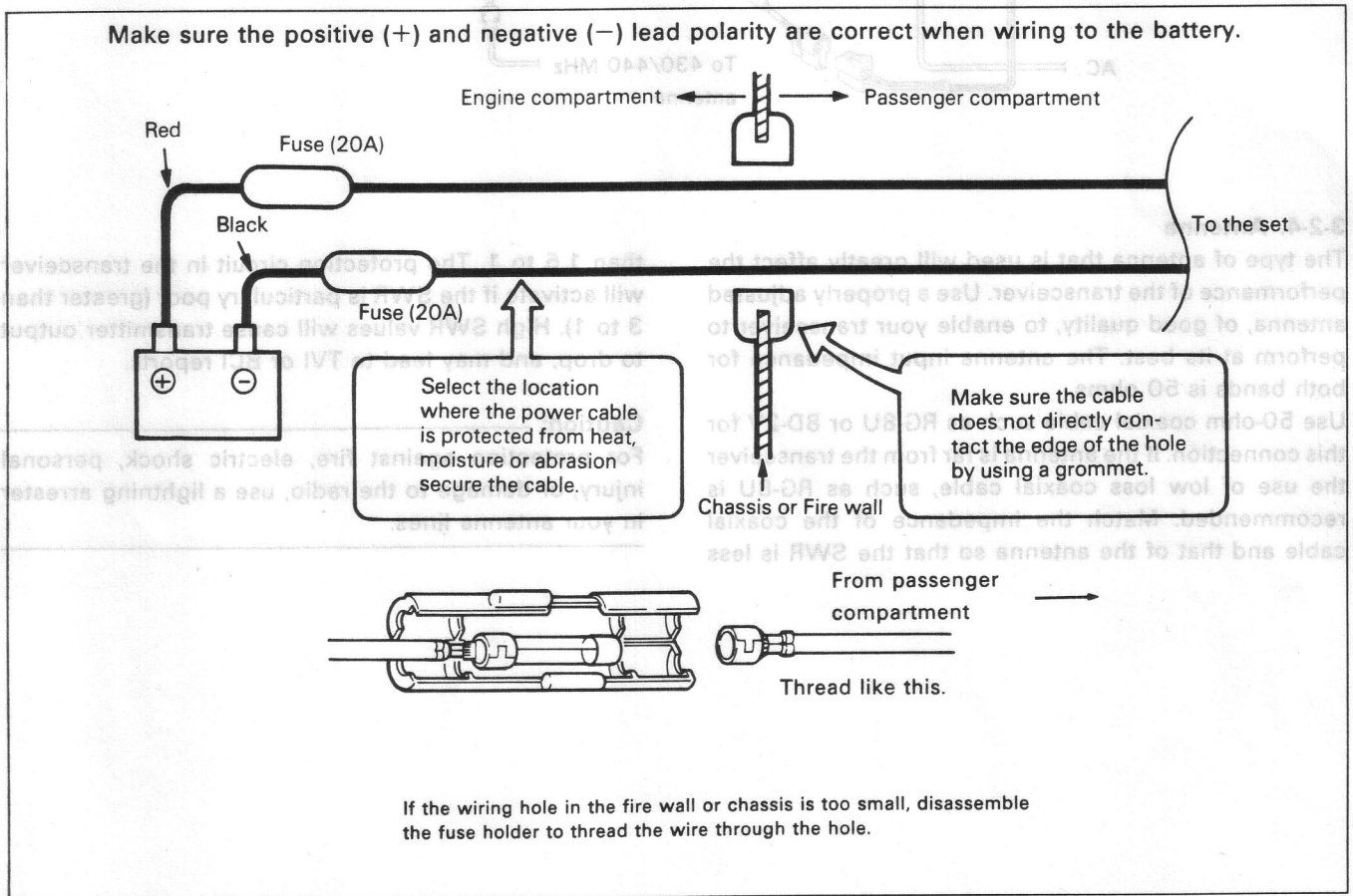
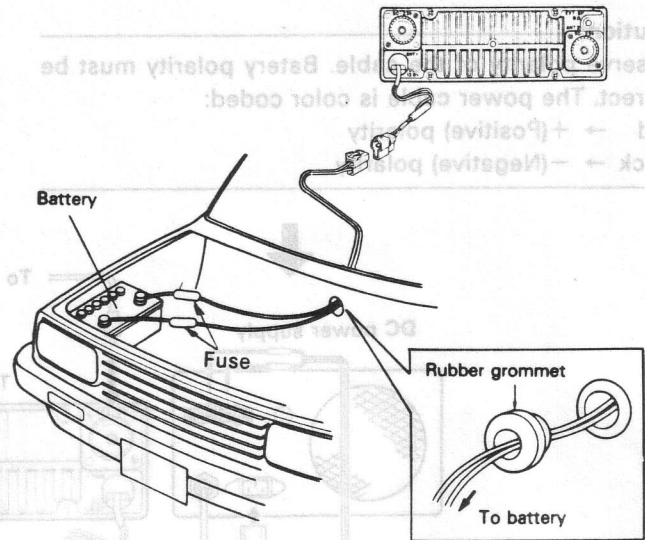

B. Ignition noise

This transceiver is designed to suppress ignition noise; however, if excessive noise is present, it may be necessary to use suppressor spark plugs (with resistors), or an external noise filter such as the PG-3B.

3-2-3. Fixed Station

Connect the transceiver to a regulated 13.8 VDC power supply only. The use of the PS-430 or the PS-50 is recommended.

Caution:

1. Never connect the AC cable to the AC outlet until all connections have been made.
2. Before connecting and disconnecting the power connector, be sure to turn off the power switches of both the transceiver and the DC power supply.

3. INSTALLATION AND CONNECTION

3-1. INSTALLATION (MOBILE)

The MB-11 Mobile Mount is supplied for convenient mobile mounting.

When installing the transceiver in a vehicle, consider ease of operation and safety when selecting the installation location.

Installing the MB-11 Mobile Mount

The bracket should be installed as shown below.

(a) Bracket

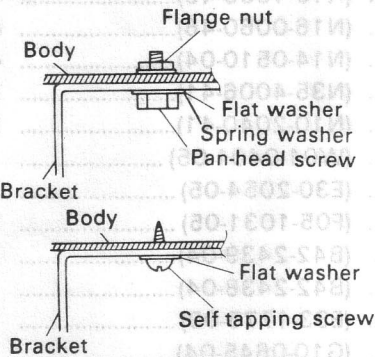

(b) Set

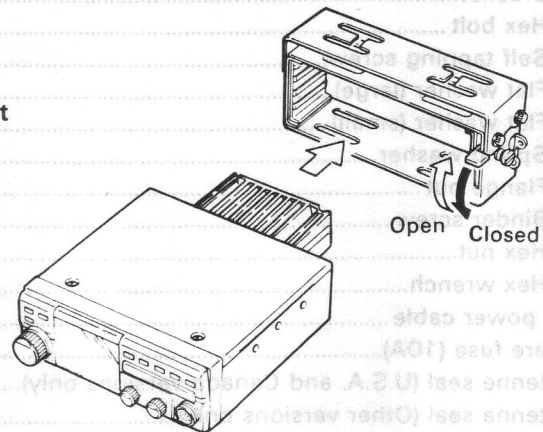

3-2. CONNECTION

3-2-1. Precautions

1. Before connecting and disconnecting the power connector, be sure to turn off the power switches of the transceiver and the DC power supply.

2. Observe polarity of the cable. The transceiver operates on 13.8 VDC, negative ground. Battery polarity must be correct. The power cable is color coded:
 Red → + (Positive) polarity
 Black → - (Negative) polarity

3-2-2. Mobile

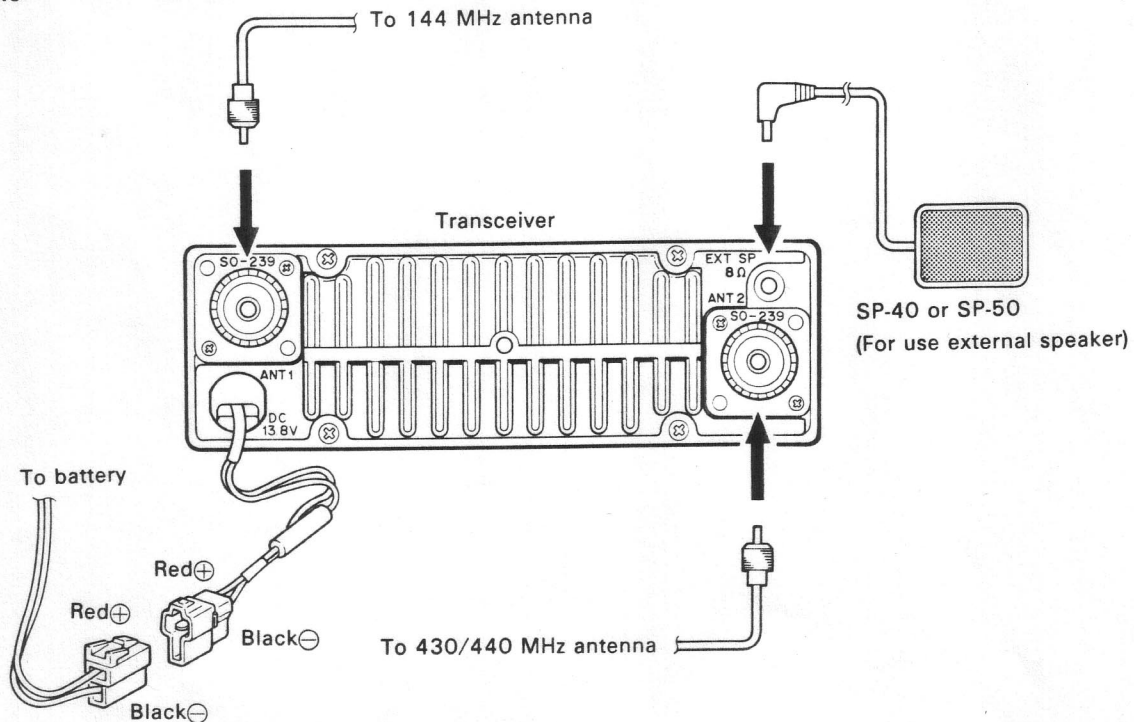

A. Battery connection

Connect the supplied power cable with fuse directly to the battery terminals. Connecting to the cigarette lighter socket can cause a poor connection, and excessive voltage drop.

Caution:

1. When connecting or disconnecting the power cable to or from the power connector, be sure that the power switch is always in the "OFF" position.
2. Disconnect the transceiver before jump-starting or before charging the battery.

2-2. ACCESSORIES

Unpack your transceiver carefully and confirm that it is supplied with the following accessories.

DTMF Microphone (U.S.A. version only)	(T91-0359-05)	1 ea.
Dynamic Microphone (Except U.S.A. version)	(T91-0357-15)	1 ea.
Mobile Mount (MB-11)		
Bracket	(J29-0414-22)	1 ea.
Hex bolt	(N09-0008-04)	4 ea.
Self tapping screw	(N09-0632-05)	4 ea.
Flat washer (large)	(N15-1060-46)	4 ea.
Flat washer (small)	(N15-1050-46)	4 ea.
Spring washer	(N16-0060-46)	4 ea.
Flange nut	(N14-0510-04)	4 ea.
Binder screw	(N35-4006-41)	2 ea.
Hex nut	(N10-2040-41)	2 ea.
Hex wrench	(W01-0401-05)	1 ea.
DC power cable	(E30-2054-05)	1 ea.
Spare fuse (10A)	(F05-1031-05)	2 ea.
Antenne seal (U.S.A. and Canada versions only)	(B42-2439-04)	1 ea.
Antenna seal (Other versions only)	(B42-2438-04)	1 ea.
Connector cables for the Tone unit and Modem unit	(E33-1775-00)	1 ea.
Tone unit (TU-7) mounting tape	(G10-0645-04)	1 ea.
Modem unit (MU-1) mounting cushion	(G13-0837-14)	1 ea.
Instruction manual	(B50-8142-XX)	1 copy
Warranty card (U.S.A. only)	1 ea.

After unpacking

Shipping container:

Save the boxes and packing in the event your unit needs to be transported for remote operation, maintenance, or service.

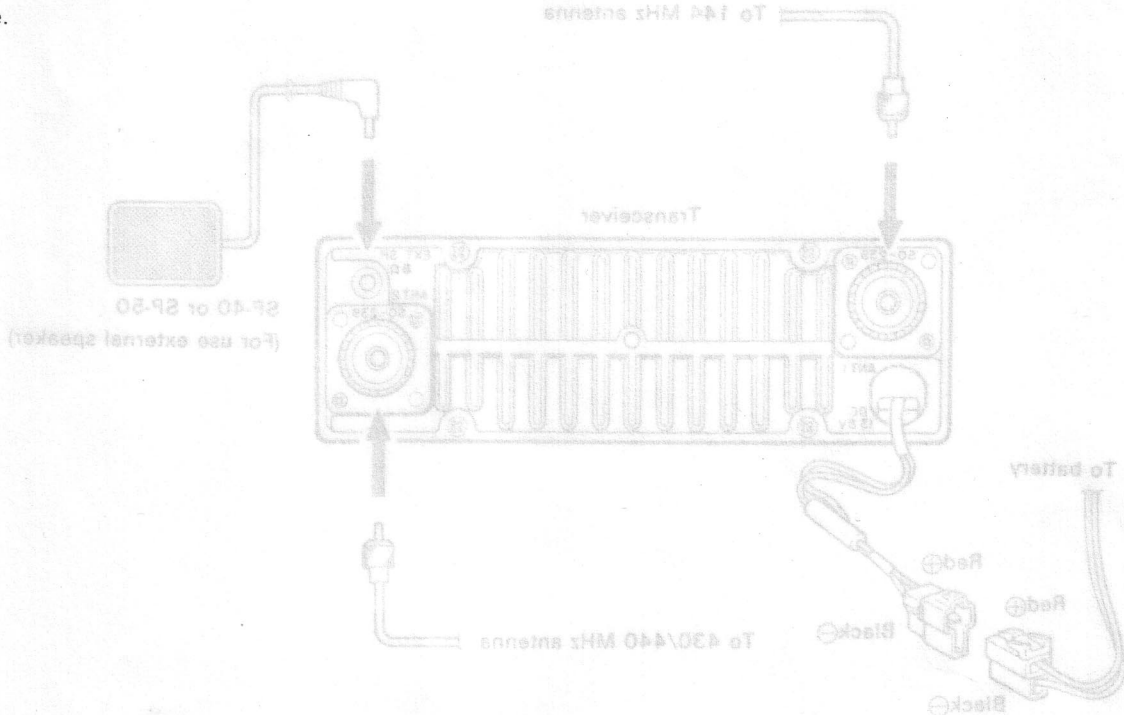

Caution:
 1. When connecting or disconnecting the power cable to or from the power connector, be sure that the power switch is always in the "OFF" position.
 2. Disconnect the transceiver before jump-starting or before charging the battery.

A. Battery connection
 Connect the supplied power cable with fuse directly to the battery terminals. Connecting to the cigarette lighter socket can cause a poor connection, and excessive voltage drop.

2. SPECIFICATIONS AND ACCESSORIES

2-1. SPECIFICATIONS

Specifications		Model				
		TW-4100A U.S.A. version	Canada version	Other markets version	TW-4100E	
General	Frequency range	144 to 148 MHz 440 to 450 MHz	144 to 148 MHz 440 to 450 MHz	142 to 149 MHz*1 430 to 440 MHz	144 to 146 MHz 430 to 440 MHz	
	Mode	FM (F3E, F2D for the control signal of the DCL system)				
	Antenna impedance	50 ohms				
	Power requirements	13.8 VDC \pm 15%				
	Ground	Negative				
	Current drain	Receive mode with no input signal	0.6 A			
		Transmit mode (Max.)	9.5 A			
	Frequency stability (-10°C to +50°C)	Better than $\pm 15 \times 10^{-6}$				
	Operating temperature	-20°C to +60°C (-4°F to +140°F)				
	Dimensions (W \times H \times D) (Projec- tions included)	150 \times 50 \times 214 mm (5-29/32" \times 2" \times 8-7/16")				
Weight	1.8 kg (3.97 lbs)					
Transmitter	Output power**2	HI	144 MHz:45W, 430/440 MHz:35W			
		LOW	5W			
	Modulation	Reactance modulation				
	Spurious radiation	Less than -60 dB				
	Maximum frequency deviation	\pm 5 kHz				
	Audio distortion (at 60% modulation)	Less than 3% (300 to 3000 Hz)				
Microphone impedance	500 to 600 ohms					
Receiver	Circuitry	Double conversion superheterodyne				
	Intermediate frequency	1st IF	30.825 MHz			
		2nd IF	455 kHz			
	Sensitivity (12 dB SINAD)	144 MHz:Less than 0.2 μ V, 430/440 MHz:Less than 0.16 μ V				
	Selectivity	-6 dB	More than 15 kHz			
		-60 dB	Less than 30 kHz			
	Spurious response	Better than 60 dB				
	Squelch sensitivity	Less than 0.16 μ V				
Output	More than 2W across 8 ohms load (5% distortion)					
External speaker impedance	8 ohms					
DCL control	Code	NRZ equal-length code				
	Modulation	MSK modulation				
	Frequency deviation	\pm 3.5 kHz (Reference)				
	Mark frequency and deviation	1200 Hz, $\pm 2 \times 10^{-4}$				
	Space frequency and deviation	1800 Hz, $\pm 2 \times 10^{-4}$				
	Code transmission speed and deviation	1200 bits/second, $\pm 2 \times 10^{-4}$				

Notes:

1. Circuit and ratings are subject to change without notice due to advancements in technology.
2. *1: Specifications are guaranteed for the amateur band only.

3. *2: Recommended duty cycle
1 minute : Transmission
3 minutes : Reception

8-2. MOBILE INSTALLATION

8-2-1. Noise reduction

In motor vehicles, noise is generated by the ignition system. Other sources of noise include the wiper and heater motors.

It is imperative that some preventive measures be taken to reduce the noise to the lowest possible level.

(A) Antenna location selection

Since ignition noise is generated by the vehicles engine, the antenna must be installed as far from the engine as possible.

(B) Bonding

The component parts of motor vehicles, such as the engine, transmission, muffler system, accelerator, etc., are coupled to one another at DC and low frequencies, but are isolated at high frequencies. By connecting these parts using heavy, braided ground straps, ignition noise can be reduced. This connection is called bonding".

(C) Use ignition suppressor cable or suppressor spark plugs

Noise can be reduced by using spark plugs with internal resistors, or resistive suppressor ignition cable.

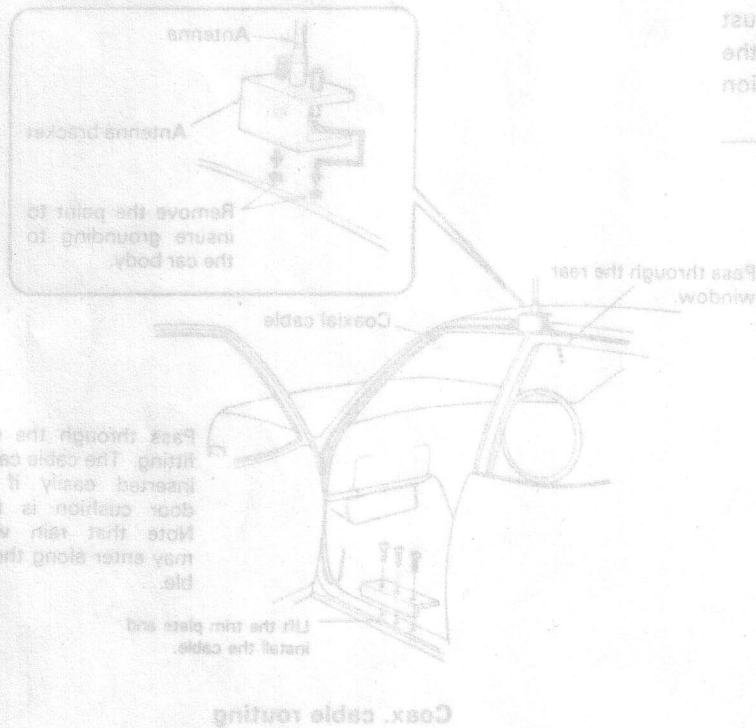

8-2-2. Battery capacity

The power system of a motor vehicle is comprised of a battery and an alternator (which generates power while the engine is running) to supply current to loads or to charge the battery.

Since the transceiver draws high current during transmit, care should be exercised so the power system is not overloaded. When using the transceiver, the following points should be observed from the viewpoint of battery maintenance:

- Turn the transceiver OFF when the lights, heater, wipers and other high-draw accessories are used.
- Avoid transceiver operation when the engine is not running.
- If necessary, use an ammeter and/or a voltmeter to check battery condition.

8-1-5 Mobile
Various types of antennas for VHF/UHF mobile operation are available.
Note:
For gutter-mount installation, the antenna bracket must be grounded to the car body as shown below. Attach the antenna securely, referring to the antenna installation instructions provided with the antenna.



Installation for mobile operation