

TRIGGERED SWEEP OSCILLOSCOPE

HIGH STABILITY

CS-1562A

DUAL TRACE OSCILLOSCOPE

INSTRUCTION MANUAL



A product of
TRIO-KENWOOD CORPORATION

6-17, 3-chome, Aobadai, Meguro-ku, Tokyo 153, Japan

FEATURES

- * The adoption of ICs throughout assures high performance and improved reliability.
- * Vertical axis of low input capacitance ($22 \pm 3\text{pF}$) for 2-channel operation provides high sensitivity and wide band-width (10 mV/div, 10 MHz).
- * The high voltage power for CRT as well as the power for other circuits is fully stabilized because of the use of DC-DC converter, thus the sensitivity and brightness are completely free from effects of voltage variations.
- * Low power consumption (20W) for cool operation.
- * X-Y operation is possible with CH2 amplifier used as X axis.

- The horizontal axis sensitivity is as high as 10mV/div, permitting accurate calibrations.
- * Time base switch allows changeover between CHOP and ALT and between V (vertical) and H (horizontal) of TV sync separator circuit, automatically and electronically.
- * At AUTO position of TRIG LEVEL, it is possible to check the brightness at no-signal time and to adjust triggering level of input waveforms.
- * All component parts are cleverly mounted on circuit boards for improved reliability.
- * Easy correction of horizontal trace angle with unique trace rotation system.

SPECIFICATIONS

Type of Cathode Ray

Tube: C529P31B or 130BEB31
Acceleration Voltage: 2kV

Vertical Axis (for both CH1 and CH2)

Sensitivity: 10 mV/div ~ 20 V/div $\pm 5\%$
Attenuator: 10 mV/div ~ 20V/div. 1-2-5, sequence
(1 div = 1 cm)

Precisely adjustable between all ranges. Sensitivity error between ranges is $\pm 5\%$.

Input Impedance: $1\text{M}\Omega \pm 5\%$
Input Capacitance: 22 pF $\pm 3\text{pF}$
Frequency Response: DC DC-10 MHz (less than -3 dB)
AC 2 Hz ~ 10 MHz (less than -3 dB)

Rising Time: Less than 35 nsec.
Overshoot: Less than 3%
(at 100 kHz square wave)

Cross-talk: Better than 70 dB at 1 kHz
Operating Mode: CH1 Channel 1 only
CH2 Channel 2 only
DUAL 2-channel (CHOP and ALT are automatically selected by SWEEP TIME/DIV) 0.5 $\mu\text{s}/\text{div}$ ~ 0.5 ms/div ALT (alternate sweep)
1 ms/div ~ 0.5 s/div:
CHOP (200 kHz switching)

CHOP Frequency: 200 kHz $\pm 20\%$
Maximum input Voltage: 600 Vp-p or 300 V (DC+AC peak)

Sweep Circuit

Sweep System: Triggering sweep and auto sweep (free-running sweep at no-signal time)

Sweep Time: 1 $\mu\text{s}/\text{div}$ ~ 0.5 s/div $\pm 5\%$ and "X-Y", 1-2-5 sequence Fine adjustment between all 18 ranges
Magnifier: 5 times $\pm 10\%$ (PULL x 5 MAG)
Linearity: Less than 3% (5 $\mu\text{s}/\text{div}$ ~ 0.5 s/div)
Less than 5%
(1 $\mu\text{s}/\text{div}$ ~ 2 $\mu\text{s}/\text{div}$)

Triggering

Source: INT: Changeover by MODE Switch
(DUAL: CH1 input signal only)
EXT: EXT TRIG input signal
Sync Section: NOR: positive and negative
TV: positive and negative
(TVH and TVV are automatically switched by SWEEP TIME/DIV)
TVH (TV-Line): 1 $\mu\text{s}/\text{div}$ ~ 50 $\mu\text{s}/\text{div}$
TVV (TV-Frame): 0.1 ms/div ~ 0.5 s/div

Triggering Voltage: CH1 and CH2.....Amplitude on CRT screen, more than 1 div
Triggering Range: INT: 20 Hz ~ 10 MHz
EXT: DC ~ 10 MHz

Horizontal Axis (CH2 input)

Operating Mode: X-Y mode is selected by SWEEP TIME/DIV.
CH1: Y axis
CH2: X axis
Sensitivity: Same as CH2
(10 mV/div ~ 20 V/div $\pm 5\%$)
Frequency Response: DC DC - 1 MHz (less than -3dB)
AC 2 Hz - 1 MHz (less than -3dB)

Input Impedance: Same as CH2 ($1\text{M}\Omega \pm 5\%$)
Input Capacitance: Same as CH2 (22 pF $\pm 3\text{pF}$)

SCHEMATIC DIAGRAM

NOTE: Resistor with no specified value are those of 1/4W and $\pm 5\%$. Also the circuit elements may be changed without notice owing to a technical innovation.

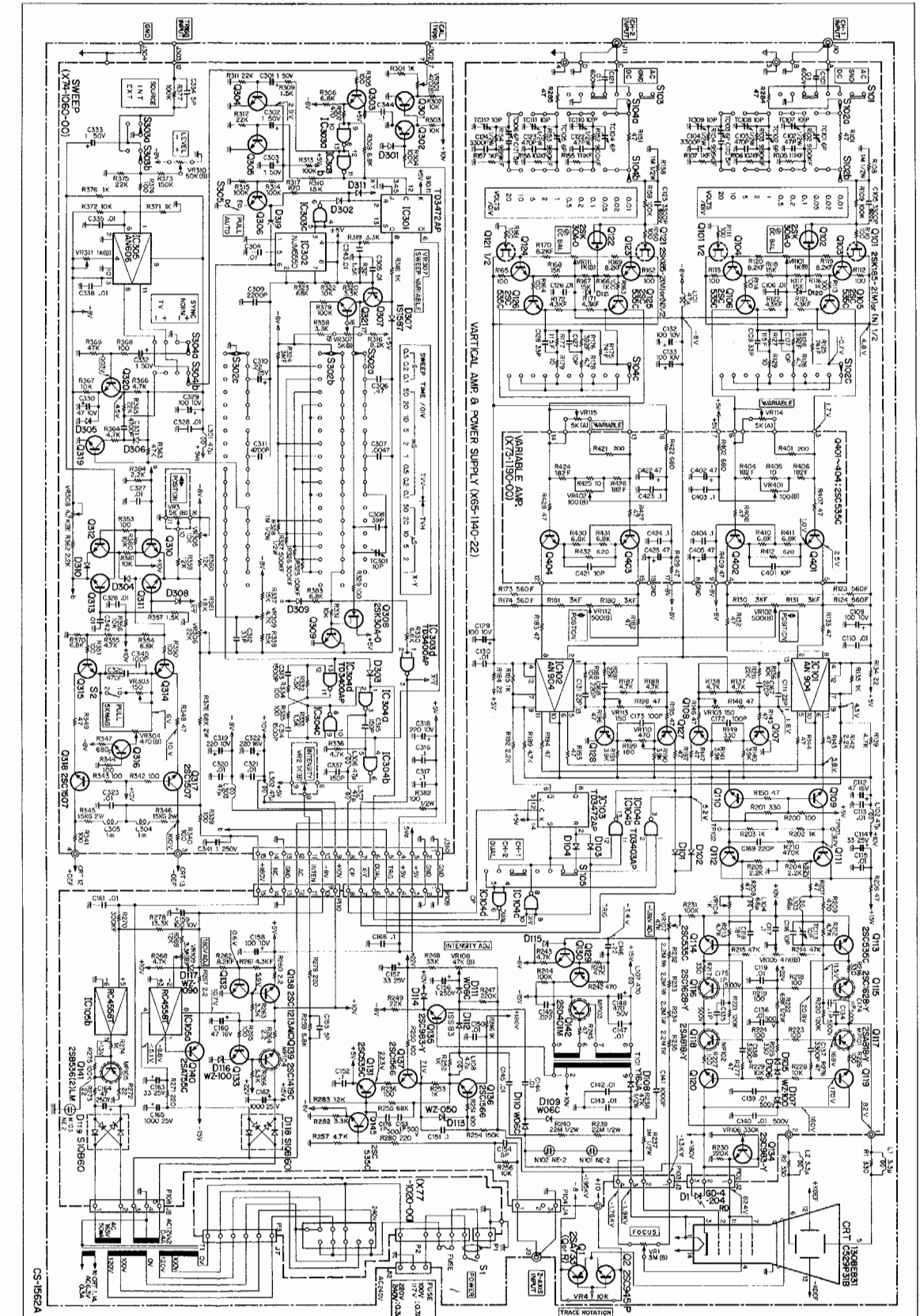

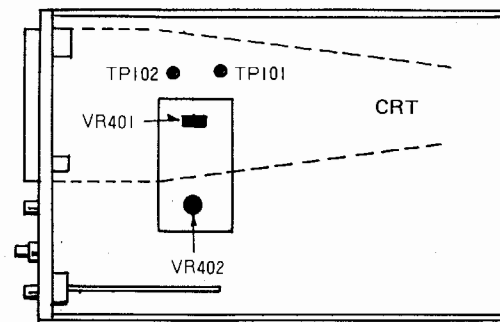

Fig. 40

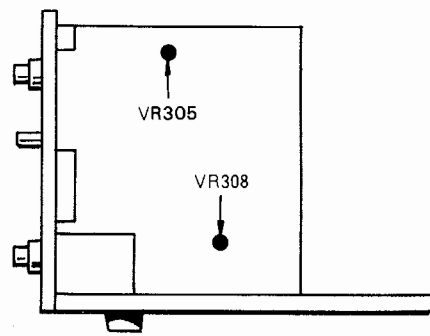

Fig. 41

CRT Centering Adjustment

1. Remove the case as described previously.
2. Short the test terminals TP101 and TP102 on the lower printed circuit board. (see Fig. 40)
3. With a bright line displayed, adjust VR105 on the same circuit board so that the bright line comes to the vertical center position. (see Fig. 39)

Horizontal Position Adjustment (see Fig. 41)

1. Remove the case as described previously.
2. To adjust the horizontal position of waveform under the normal sweep condition, proceed as follows:
With the ◀► POSITION set to its mechanical center position, adjust VR305 (POS ADJ) on the circuit board on the side wall of the case so that the waveform starts at the left end of the scale.
3. To adjust the horizontal position of the waveform when the SWEEP TIME/DIV is in the X-Y position, perform the same adjustment and then adjust VR308 on the same circuit board so that the bright spot comes to the center of the scale.

ASTIG Adjustment (see Fig. 39)

Adjust VR106, on the lower printed circuit board, through the adjustment hole in the bottom cover until the bright line offers the same thickness. This adjustment should be performed at the same time with the FOCUS control. Once it is adjusted, no further adjustment is required.

Calibrating Voltage: 1 V_{p-p} ±5%
(50/60 Hz square wave)

Intensity Modulation

Input Voltage: TTL level
Input Impedance: 10 kΩ ±20%
Trace Rotation: Trace angle is adjustable by panel surface adjuster.

Power Source

Power Supply Voltage: 100/117/220/240V ±10%.
50/60 Hz
Power Consumption: 20 W

Dimensions and Weight

Width: 260 mm (277 mm)
Height: 190 mm (204 mm)
Depth: 375 mm (433 mm)
 Figures in () show maximum sizes.

Weight: 8 kg

Accessories

Probe*: PC-21 2
 Damping 1/10
 Input impedance 10 MΩ
 Input capacitance less than 18 pF

(* Not all of sets have these.)

Pin-plug: Non-shorting type 1

AC Power Cord: 1

Replacement Fuse: 0.3A 2

0.7A 2

Instruction Manual: 1 copy

CONTROLS ON PANELS

Front Panel

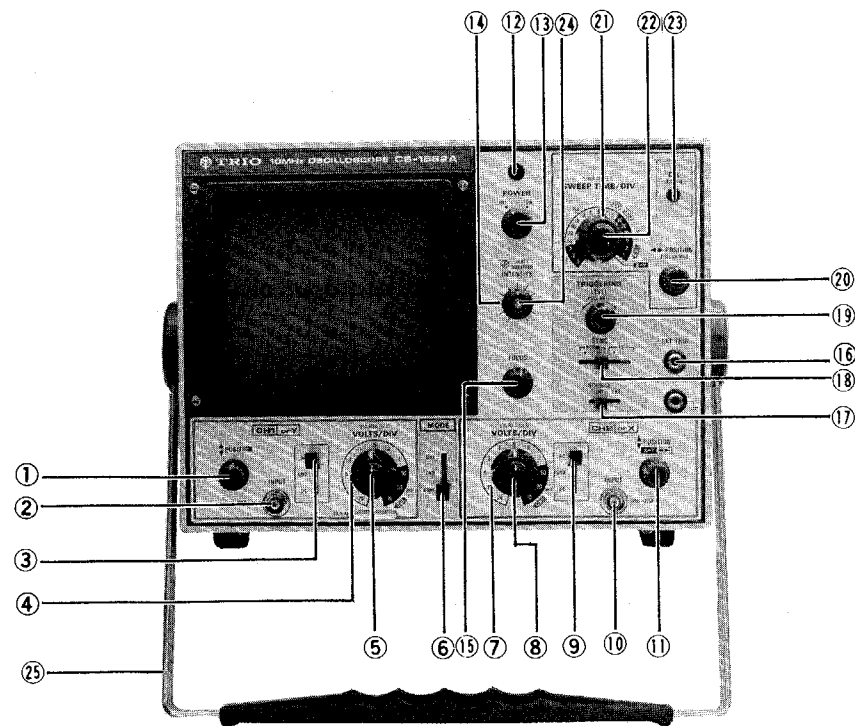

1. POSITION Control

This control adjusts vertical position during CH1 operation and Y position during X-Y operation. Waveforms can be set to any desired vertical position. Turning this control to the right will shift waveform upward, and vice versa.

2. INPUT Jack

Vertical input jack for CH1 (or Y in X-Y mode).

3. AC-GND-DC Switch

Vertical input selector for CH1 (or Y). In AC position, the DC component of input signal is blocked by a capacitor.

In GND position, the input terminal is opened and the input of internal amplifier is grounded.

In DC position, the input terminal is directly connected to the amplifier and all components of the input signal are amplified.

4. VOLTS/DIV Switch

Vertical attenuator for CH1 (or Y). The scale is graduated in voltage per "div" of CRT screen area. Calibrated voltage is indicated when VARIABLE (5) is turned fully clockwise.

Set this control for proper waveform according to the input voltage used. Selectable in 11 ranges from

0.01V/div to 20V/div.

5. VARIABLE Control

Vertical attenuator for fine control of vertical sensitivity of CH1 (or Y). It continuously controls between 11 ranges of VOLT/DIV (4). In the extreme clockwise (CAL) position, the vertical attenuator is calibrated.

6. MODE Switch

CH1: Only the input signal to CH1 is displayed as a single trace.

CH2: Only the input signal to CH2 is displayed as a single trace.

DUAL: The CH1 and CH2 waveforms are displayed at the same time, permitting dual trace observation. In this case, only the CH1 signal is synchronized. Selection between ALT and CHOP operations is automatically accomplished by turning SWEEP TIME/DIV. In the CHOP operation, the signals of both channels are alternately switched in the range of 0.5s to 1ms, by about 200kHz signal; in the ALT operation, these signals are alternately switched for each sweep in the range of 0.5ms to 1μs.

AC Voltage selector:

The oscilloscope may be operated from 100V, 117V, 220V, 240V, putting the AC voltage selector in place of another. (Refer to Fig. 38)

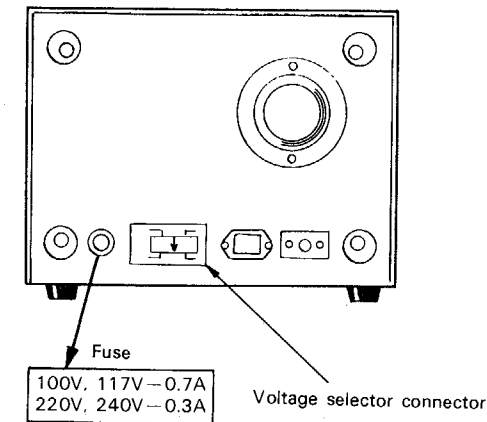

Fig. 38

Adjustment of CRT bright line azimuth:

CRT bright line angle adjustment. Adjust the TRACE ROTATION (front panel) until the bright line is aligned with the horizontal line marked on the CRT scale.

ADJUSTMENT:

Observe the following before making adjustments:

The oscilloscope is factory adjusted prior to shipment. If readjustment becomes necessary, the following points should be observed.

1. Check the power supply for correct voltage.
2. For adjustments, use a well insulated screwdriver.
3. Before making adjustments, be sure to turn on the power and wait until the unit is stabilized.
4. For adjustments, follow the procedures described below.
5. If special test instruments are required for adjustments, contact Trio's service station.

180V ADJ Adjustment

1. Remove the bottom plate as described previously.
2. Adjust VR109 on the lower circuit board so that 180V appears on the No. 15 pin of the connector P110 on the same circuit board. (see Fig. 39)

Blanking Voltage Adjustment

1. Pull the PULL AUTO knob to display a bright line on CRT.
2. Adjust VR108 on the lower circuit board through so that bright line disappears at 9 ~ 11 o'clock position of the brightness adjustment knob. (see Fig. 39)

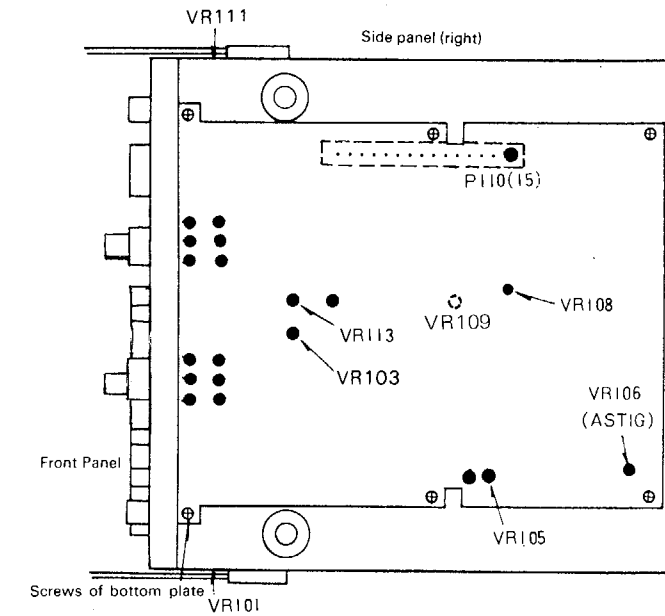

Fig. 39

Step ATT DC BAL Adjustment (see Fig. 39):

This adjustment is required when the bright line moves up and down by turning the vertical attenuator (VOLTS/DIV).

1. Set the CH1 vertical input selector switch (AC-GND-DC) to GND. Then center the bright line by pulling the PULL AUTO knob.
2. Turn the vertical attenuator (VARIABLE) fully counterclockwise. Adjust VR101 through the hole on the left side of the case so that the bright line is not deflected as the attenuator VOLTS/DIV is turned.
3. Make adjustment for CH2 in the same manner using VR111 in the hole at the right side of the case.

Variable DC BAL Adjustment (see Fig. 40):

This adjustment is required when the bright line moves up or down by turning the vertical attenuator VARIABLE.

1. Remove the case as described previously. For adjustment, use the auxiliary printed circuit board on the bottom. Adjust CH1 with VR401 from the left side and CH2 with VR402 from the top.
2. Turn the variable attenuator VARIABLE fully counterclockwise so that the bright line is centered on the scale. Then, turn the attenuator (VARIABLE) fully clockwise. If, at this time, the bright line shifts up or down, adjust VR401 or VR402 until it stays in the center position.
3. Repeat the above procedures until the bright line is stabilized when the attenuator (VARIABLE) is rotated.

PRECAUTIONS

1. Avoid using the oscilloscope in a location exposed to direct sunlight.
2. Select a place free from high temperature and humidity. Do not use the oscilloscope in a dusty location.
3. Do not operate the oscilloscope in a place where mechanical vibrations are excessive or a place near equipment which generates strong magnetic fields or impulse voltages.
4. This oscilloscope is factory set for AC 240V operation. For AC 100V, 117V or 220V operation, change the position of the plug of the voltage selector at the rear panel as indicated by the arrow. When the oscilloscope is to be operated with AC 100V, 117V, be sure to replace the fuse with one rated at 0.3A.
5. Do not apply input voltages exceeding their maximum ratings. The input voltage to the vertical amplifier is up to 300V (DC+AC peak), the input for EXT. TRIG is up to 50V (DC+AC peak), and the input to Z AXIS is up to 100V (DC+AC peak).
6. Do not increase the brightness of the CRT unnecessarily.
7. Do not leave the oscilloscope for a long period with a bright spot displayed on CRT. Reduce the brightness and soften the focus.

8. Setting the oscilloscope

The oscilloscope is provided with a handle which can be fixed at 22.5° angle intervals, permitting it to be set either vertically, horizontally or aslant.

Do not place any object on the oscilloscope or cover the ventilation holes of the case with a cloth or the like, as it will increase the temperature inside the case.

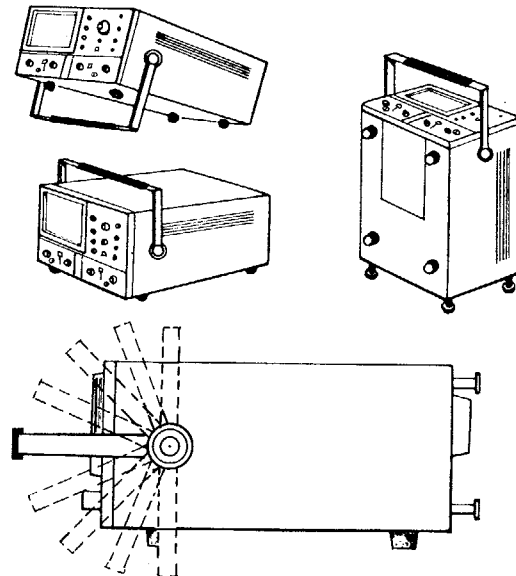

Fig. 35

MAINTENANCE AND ADJUSTMENT

MAINTENANCE

Removing the case:

1. Remove the six screws from the top and side walls of the case, using a Phillips head screwdriver.

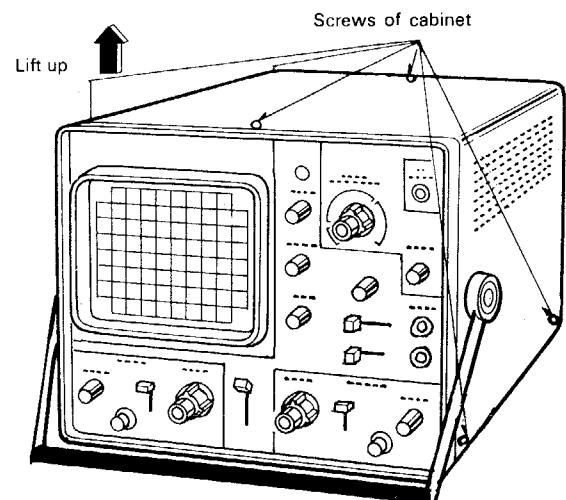

Fig. 36

2. Hold the handle and lift up. The case is now ready for removal.
3. To remove the bottom plate, unscrew the six screws using a Phillips head screwdriver.

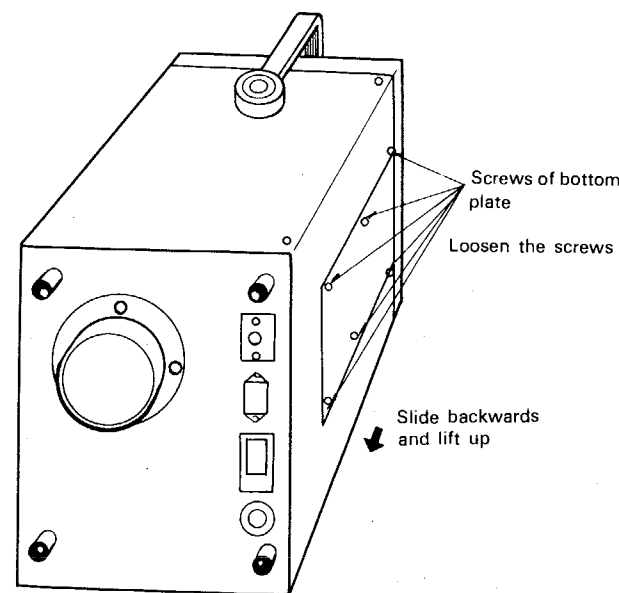

Fig. 37 Removal of bottom plate

Caution: A high voltage (2000V) is present on the CRT socket and the lower printed circuit board. Before removing the case, be sure to turn off the power, and do not touch these parts with hand or a screwdriver even after the case has been removed.

7. VOLT/DIV Switch

Vertical attenuator for CH2. It has the same function as VOLT/DIV (4), but is also used as X attenuator during X-Y operation.

8. VARIABLE Control

Vertical attenuator adjustment provides fine control of vertical sensitivity of CH2 (or X). It has the same function as VARIABLE (5).

9. AC-GND-DC Switch

Vertical input selector for CH2 (or X). It has the same function as AC-GND-DC (3).

10. INPUT Jack

Vertical input jack for CH2 (or X).

11. POSITION Control/X-Y Control

Vertical position adjuster for CH2. It functions the same as POSITION (1), but is also used as X position adjuster during X-Y operation.

12. LED Pilot Lamp

This lamp lights as the power switch ILLUM (13) is turned on.

13. POWER Switch

A right turn will set the power to ON.

14. INTENSITY Control

Adjusts the brightness of spots and waveforms for easy viewing. A left turn will allow the waveform to disappear.

15. FOCUS Control

Spot Focus control to obtain optimum waveform according to brightness.

16. EXT TRIG Jack

External sync terminal. For external synchronization, external sync voltage (more than 1Vp-p) should be applied, with SOURCE switch (17) set to EXT.

17. SOURCE Switch

Two-position switch to selects triggering source for the sweep. (INT or EXT)

SOURCE: This switch is used to select the mode of sync; either the internal sync (INT) or the external sync (EXT).

INT: When the MODE switch is set to CH1 position, the input signal of CH1 is synchronized.

At the CH2 position, the CH2 input signal is synchronized. When the switch is in DUAL position, only the CH1 input signal is synchronized.

18. SYNC Switch

Sync separator switch. It picks up sync signal component in TV video signal and applies to sync circuit for component in TV video signal and applies to sync circuit for complete synchronization of video signal being viewed.

NORM ±: Used for viewing general waveforms. In this position, TV sync separator circuit is not connected.

At "+" polarity, sweep is effected by "+" slope and, at "-" polarity, by "-" slope.

TV ±: Used for viewing wave forms with TV video signal synchronized with sync signal. TVV and TVH are automatically selected for sweep times of 0.5s to 0.1ms and 50μs to 0.5μs of SWEEP TIME/DIV rotary switch, respectively, and are synchronized with vertical and horizontal sync signals.

Polarity should be set to match that of video signal as shown in the illustration.

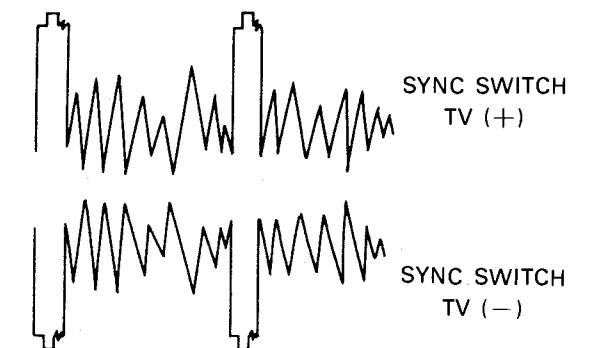

Fig. 1

19. LEVEL Control

Sync level control adjusts sync phase to determine the starting point of sweep on the slope of trigger signal waveform.

PULL AUTO Switch

By pulling LEVEL control toward you, auto-sweep is effected; the sweep is set in free-running state even when no trigger input signal is applied, with fly-back line displayed on CRT.

With trigger signal, trigger-sweep is effected where sync level is adjustable. When sync level is deviated, the sweep is set in free-running state.

20. POSITION Control

Horizontal position adjuster to shift waveform to any desired horizontal position. A right turn of the adjuster will shift the waveform to right, and vice versa.

PULL X5 MAG Switch

Sweep magnifier switch. By pulling the knob toward you, waveform is magnified 5 times in left and right directions. Brightness is slightly decreased.

21. SWEEP TIME/DIV Switch

Horizontal sweep time selector. It selects sweep times of 1μs to 0.5s in 18 steps. X-Y operation is possible by turning the knob fully clockwise. Changeover between CHOP, ALT, TVV and TVH is also accomplished automatically by this selector. When VARIABLE (22) is turned fully clockwise, calibrated reading is obtained which is the sweep time per "div".

22. VARIABLE Control

Used for fine adjustment of sweep time. Continuous adjustment between 18 steps of SWEEP TIME/DIV (21) is possible. Sweep time is calibrated at the extreme clockwise position (CAL).

23. CAL 1Vp-p Jack

Calibration voltage jack. Calibration voltage is 1Vp-p of square wave with synchronized power source.

CAL 1Vp-p: This jack is used to check the condition of vertical gain or to adjust square wave characteristics of the probe.

24. Trace Rotation

This is used to eliminate inclination of horizontal trace.

25. Handle

Use this handle to mount the oscilloscope in a slant position.

26. Z AXIS INPUT Jack

Intensity modulation jack. TTL logic-compatible, high logic increase brightness low logic decrease brightness.

27. Power Connector

For connection of the supplied AC power cord.

28. AC Voltage Selector

The CS-1562A may be operated from 100V, 120V, 220V, 240V, putting the AC Voltage Selector in the place of another.

29. Fuse Holder

For 100 ~ 117V operation a 0.7 ampere fuse should be used.
For 220 ~ 240V operation a 0.3 ampere fuse should be used.

30. Cord Reel

Wind power cord when the oscilloscope is to be carried or stored. They also serve as a stand when the oscilloscope is used in upright position.

Rear Panel

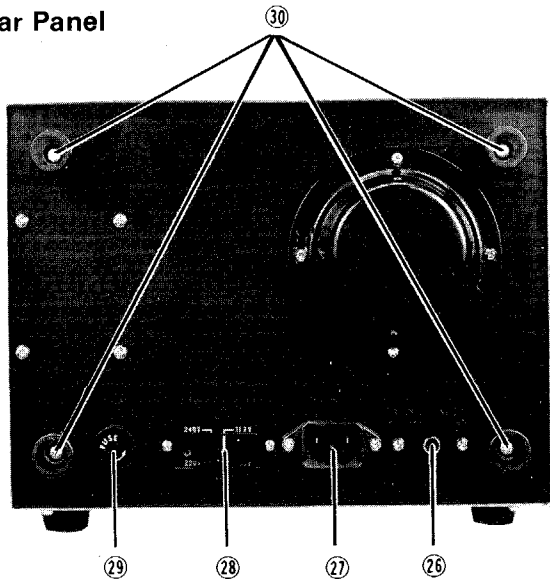

OPERATION

PRELIMINARY OPERATION

When operating this oscilloscope, refer to panel controls and their functions (see page 4).

When starting this oscilloscope set initially, set the operation controls as follows and the set may be turned on safely.

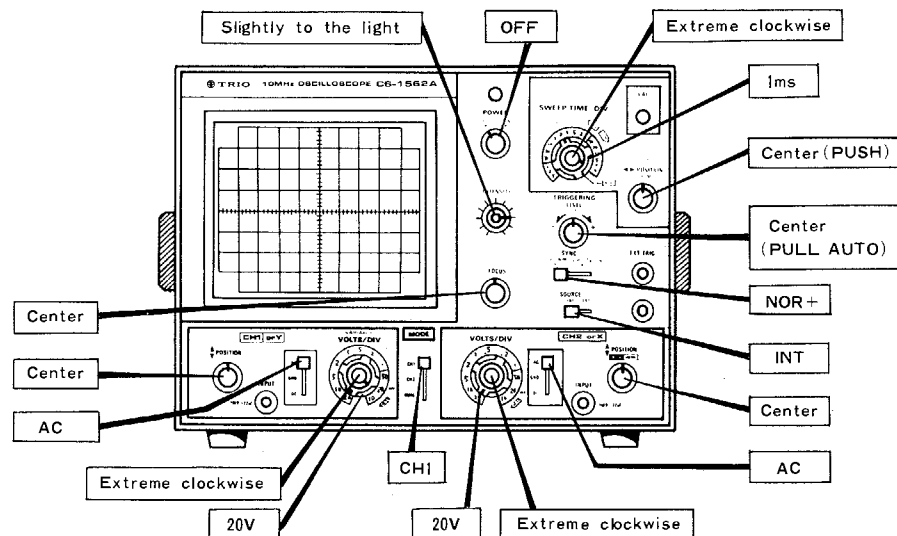

Fig. 2

Fig. 32 indicates high-frequency boost in an amplifier accompanied by a lightly damped "shock" transient. In this case, the sudden transition in the square wave potential from a sharply rising, relatively high frequency voltage, to a level value of low frequency voltage, supplies the energy for oscillation in the resonant network. If this network in the amplifier is reasonably heavily damped, then a single cycle transient oscillation may be produced as indicated in Fig. 33

Fig. 34 summarizes the preceding explanations and serves as a handy reference.

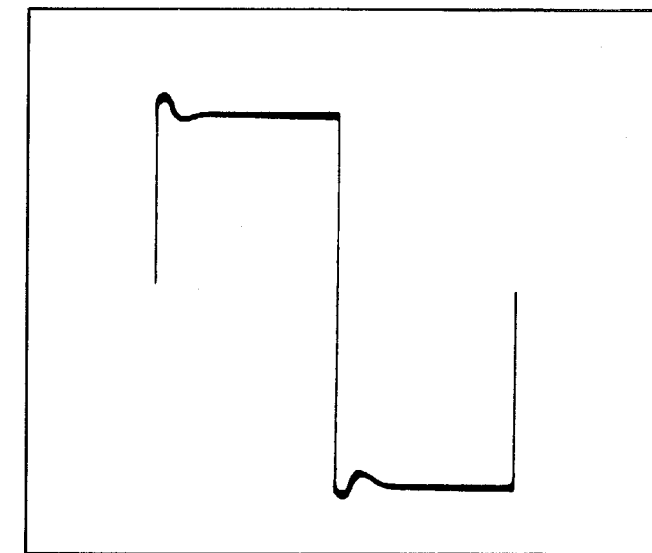

Fig. 33 Effect of high-frequency boost and good damping

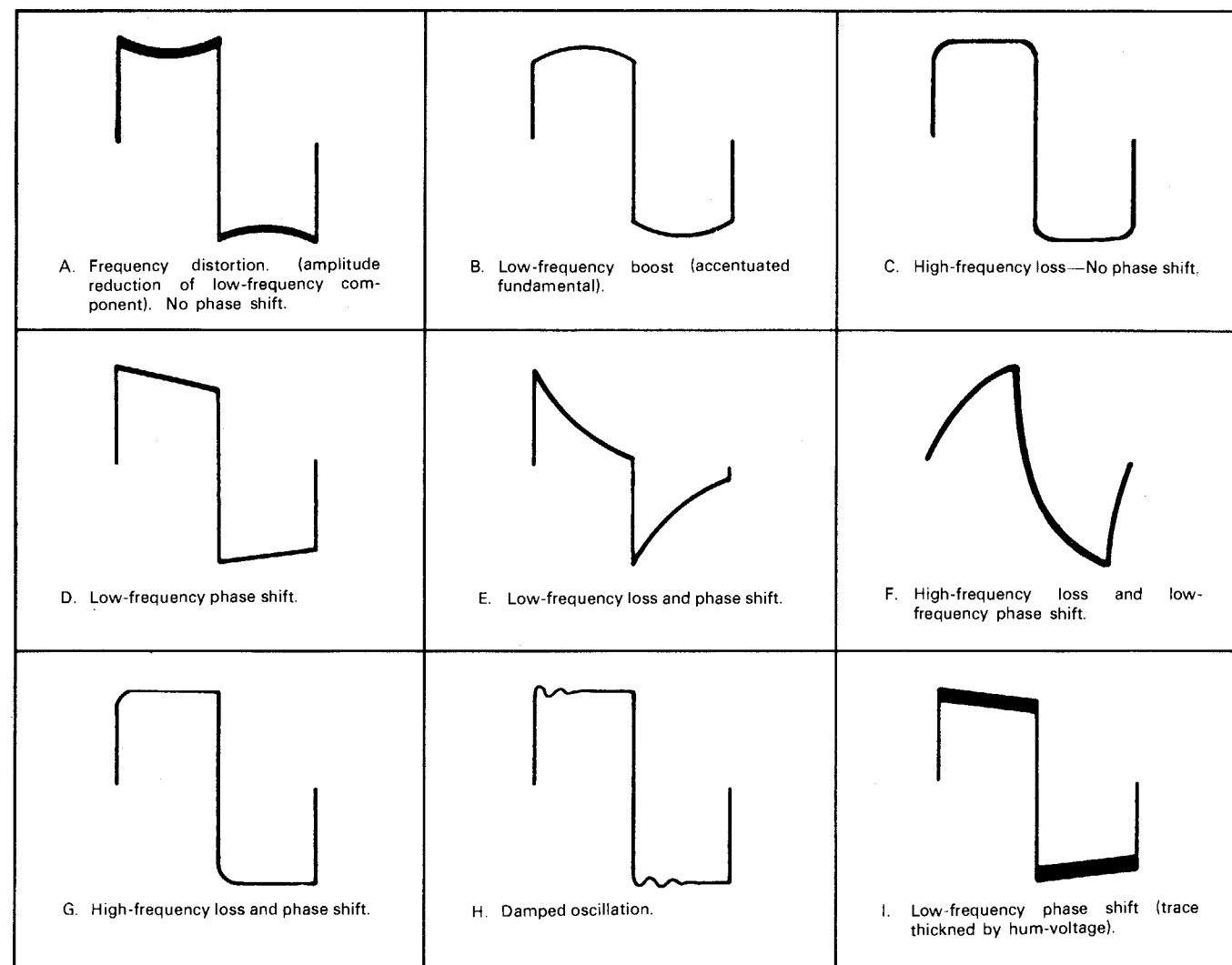

Fig. 34 Summary of waveform analysis for square wave testing of amplifiers

Fig. 28 shows a graphical development of a similarly tilted square wave. The tilt is seen to be caused by the strong influence of the phase-shifted 3rd harmonic. It also becomes evident that very slight shifts in phase are quickly shown up by tilt in the square wave.

Fig. 29 indicates the tilt in square wave produced by a 10° phase shift of a low-frequency element in a leading direction. Fig. 30 indicates a 10° phase shift in a low frequency component in a lagging direction. The tilts are opposite in the two cases because of the difference in polarity of the phase angle in the two cases that can be checked through algebraic addition of components.

Fig. 31 indicates low-frequency components which have been reduced in amplitude and shifted in phase. It will be noted that these examples of low-frequency distortion are characterized by a change in shape of the flat portion of the square wave.

Fig. 26B shows a high-frequency overshoot produced by rising amplifier response at high frequencies. It should

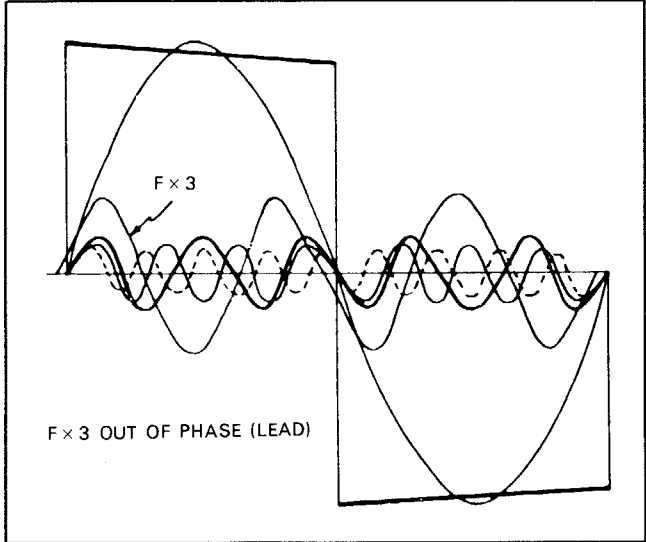

Fig. 28 Square wave tilt resulting from 3rd harmonic phase shift

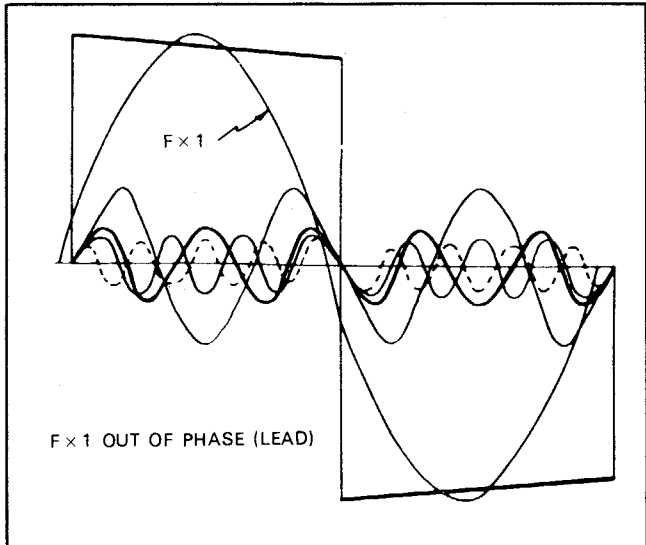

Fig. 29 Tilt resulting from phase shift of fundamental frequency in a leading direction

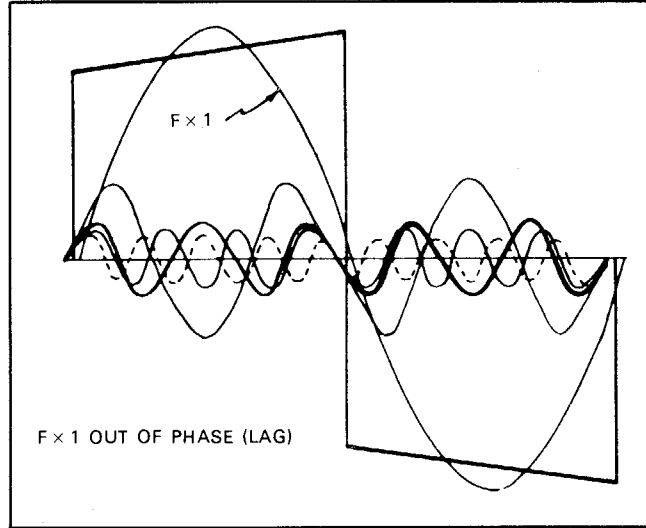

Fig. 30 Tilt resulting from a phase shift of fundamental frequency in a lagging direction.

again be noted that this overshoot makes itself evident at the top of the leading edge of the square wave. The sharp rise of the leading edge is created by the summation of a large number of harmonic components. If an abnormal rise in amplifier response occurs at high frequencies, the high frequency components in the square wave will be amplified more than the other components creating a higher algebraic sum along the leading edge.

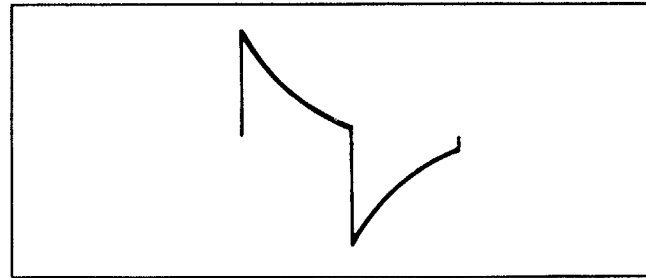

Fig. 31 Low frequency component loss and phase shift

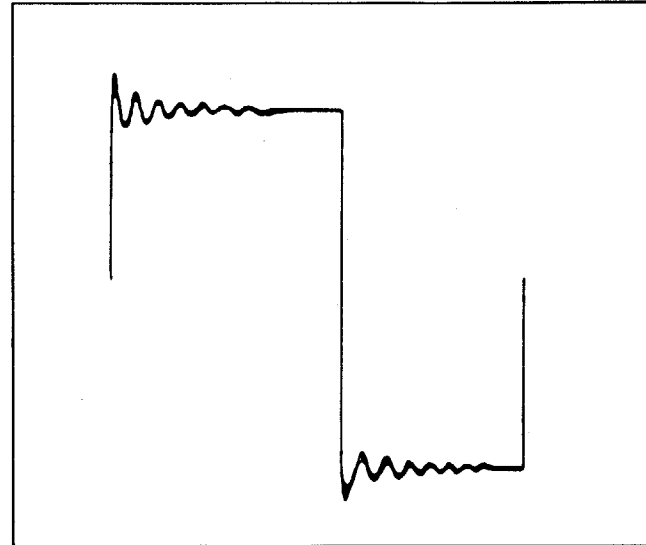

Fig. 32 Effect of high-frequency boost and poor damping

OPERATING PROCEDURES

Insert the supplied AC power cord to the power connector and power source. The CS-1562A is designed to be operated on AC 117/230V. Confirming your power source voltage before insert the power connector.

- (1) Turn POWER (13) clockwise. The power is turned to ON and LED pilot lamp (12) lights.
- (2) Horizontal axis will be displayed. When fly-back line does not appear at the center of the screen, adjust POSITION (1) and POSITION PULL X5 MAG (20). Adjust brightness with INTENSITY (14). If fly-back line is unclear, adjust FOCUS (15).
- (3) The oscilloscope is now ready for measurements. Apply a signal to be measured to INPUT (2). Turn VOLTS/DIV (4) clockwise to obtain the desired size of waveform. Set the SOURCE (17) to INT position and the MODE (6) to CH2 position, the signal applied to INPUT (10) is then displayed. By setting the MODE (6) to DUAL position, both the CH1 signal applied to INPUT (2) and

- (4) When the signal voltage is more than 0.01V and waveform fails to appear on the screen, the oscilloscope may be checked by feeding input from CAL 1V-p-p (23). Since calibration voltage is 1Vp-p, the waveform becomes 5 div high at the 0.2V/div position.
- (5) By pushing LEVEL (19), the free-running auto function is released. The waveform disappears when the knob is turned clockwise, and appears again at the approximate mid position of it. Sync phase is also adjustable in this case. The waveform will again disappear when the knob is turned counterclockwise from the mid position.
- (6) When DC component is measure, set AC-GND-DC to DC position. If, in this case, the DC component contains plus "+" potential, the waveform moves upward and if it contains minus "-" potential, the waveform moves downward. The reference point of "0" potential can be checked at GND position.

APPLICATIONS

DUAL-TRACE APPLICATIONS

Introduction:

The most obvious and yet the most useful feature of the dual-trace oscilloscope is that it has the capability for simultaneously viewing two waveforms that are frequency or phase-related, or that have a common synchronizing voltage, such as in digital circuitry. Simultaneous viewing of input and its output is an invaluable aid to the circuit designer or the repairman. Several possible applications of the dual-trace oscilloscope will be reviewed in detail to familiarize the user further in the basic operation of this oscilloscope.

Frequency Divider Waveforms Viewing:

Fig. 4 illustrates the waveform involved in a basic divide-by-two circuit. Fig. A indicates the reference or clock

pulse train. Fig. B and Fig. C indicate the possible outputs of the divide-by-two circuitry. Fig. 4 also indicates the settings edge of the reference frequency pulse by a time interval corresponding to the pulse width.

of specific oscilloscope controls for viewing these waveforms. In addition to these basic control settings, the TRIGGERING LEVEL control, as well as the Channel 1 and Channel 2 vertical position controls should be set as required to produce suitable displays. In the drawing of Fig. 4, the waveform levels of 2div are indicated. If exact voltage measurements of Channel 1 and Channel 2 are desired, the Channel 1 and Channel 2 VARIABLE controls must be placed in the CAL position. The Channel 1 waveform may be either that indicated in Fig. 4B or Fig. 4C. In Fig. 4C, the divide-by-two output waveform is shown which occurs during the falling time of pulses. In this case, the output waveform is shifted with respect to the leading.

Divide-by-8 Circuit Waveforms:

Fig. 3 indicates waveform relationships for a basic divide-by-eight circuit. The oscilloscope settings are identical to those used in Fig. 4. The reference frequency of Fig. 3A is supplied to the Channel 2 input, and the divide-by-eight output is applied to the Channel 1 input. Fig. 3 indicates the time relationship between the input pulses and output pulses.

In an application where the logic circuitry is operating at or near its maximum design frequency, the accumulated rise time effects of the consecutive stages produce a built-in time propagation delay which must be compensated for. Fig. 3C indicates the possible time delay which may be introduced into a frequency divider circuit. By use of the

dual-trace oscilloscope, the input and output waveforms can be superimposed (ADD or SUB) to measure the exact amount of propagation delay that occurs.

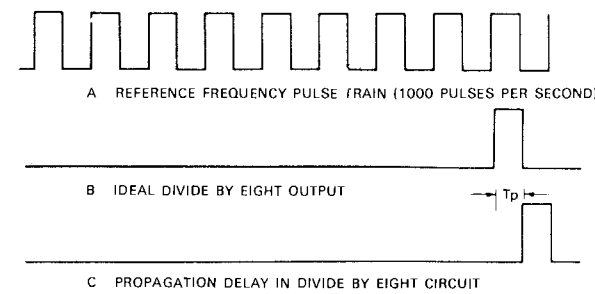

Fig. 3 Waveforms in divide-by-eight circuit

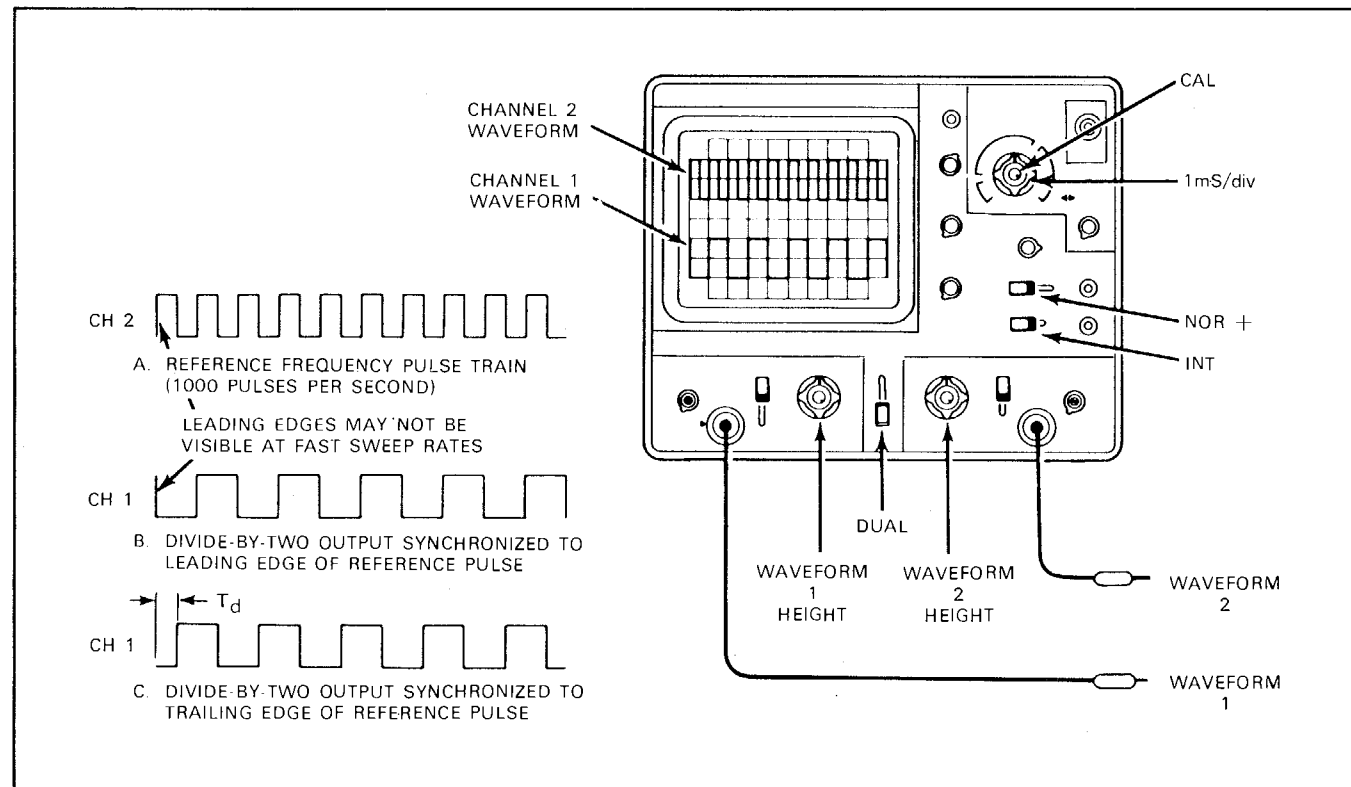

Fig. 4 Waveforms in divide-by-two circuit

Digital Circuit Time Delay Measurement:

Since a dual-trace oscilloscope has the capability of comparing the timing of one waveform with another, it is necessary in designing, manufacturing and servicing digital equipment. In digital equipment, many of the circuits are frequency dividers as previously described, but waveforms are often time-related in many other combinations. Fig. 5 shows a typical digital circuit and identifies several of the points at which waveform measurements are appropriate. Under the operating condition, waveforms will vary according to the input or operating mode. Fig. 6 shows the relationship between the normal waveforms to be expected at each of these points and their timing. If the correct time relationship with respect to other waveform is unknown, measurement of individual waveforms means nothing. The dual-trace oscilloscope allows this comparison to be made. In an application, waveform No. 3 would be displayed on

Channel 2 and waveform No. 4 through No. 8 and No. 10 would be displayed on Channel 1. Waveforms No. 11 through No. 13 would probably be displayed on Channel 2 in relationship to waveform No. 8 or No. 4 on Channel 1. No. 8 or No. 10 is an excellent sync source for viewing all of the waveforms.

With No. 8 or No. 10 used as external sync source, any of the waveforms may be displayed without readjustment of the TRIG LEVEL control. Waveforms No. 4 through No. 7 should not be used as the sync source because they do not contain a triggering pulse at the start of the frame. It would not be necessary to view the entire waveforms as shown in Fig. 6 in all cases. In fact, there are many times when a closer examination of a portion of the waveforms would be appropriate. In such cases, it is recommended that the sync remain unchanged while the sweep speed be increased or X5 MAG control used to expand the waveform display.

2. The second is non-linear distortion and refers to a change in waveshape produced by application of the waveshape to non-linear elements such as vacuum tubes, an iron core transformer or a clipper network.
3. The third is delay or phase distortion, which is distortion produced by a shift in phase between some components of a complex waveform.

In actual practice, a change in amplitude of a square wave component is usually caused by a frequency selective network which includes capacity, inductance or both. The presence of the C or L introduces a difference in phase angle between components, creating phase distortion or delay distortion. Therefore, in square wave testing of practical circuitry, we will usually find that the distorted square wave includes a combination of amplitude and phase distortions.

In a typical wide band amplifier, a square wave check reveals many distortion characteristics of the circuit. The response of an amplifier is indicated in Fig. 25, revealing poor low-frequency response along with the overcompensated high-frequency boost. The response of 100Hz square wave applied to the amplifier will appear as in Fig. 26A. This figure indicates satisfactory medium frequency response (approximately 1kHz to 2kHz) but shows poor low frequency response. Next, a 1kHz square wave applied to the input of the amplifier will appear as in Fig. 26B. This figure displays good frequency response in the region of 1000 to 4000Hz but reveals a sharp rise at the top of the leading edge of the square wave because of overcompensation at the frequencies of more than 10kHz.

As a rule of thumb, it can be safely said that a square wave can be used to reveal response and phase relationships up to the 15th or 20th odd harmonic or up to approximately 40 times the fundamental of the square wave. It is seen that wide-band circuitry will require at least two frequency check points to correctly analyze the entire bandpass.

In the case illustrated by Fig. 25, a 100Hz square wave will encompass components up to about 4kHz. To analyze above 4kHz and beyond 10,000Hz, a 1kHz square wave should be used.

Now, the region between 100Hz and 4000Hz in Fig. 25 shows a rise from poor low-frequency (100Hz to 1kHz) response to a flattening out from beyond 1000 and 4000Hz. Therefore, we can expect that the higher frequency components in the 100Hz square wave will be relatively normal in amplitude and phase but that the low-frequency components "B" in this same square wave will be modified by the poor low-frequency response of this amplifier (see Fig. 26A).

If the amplifier were such as to only depress the low frequency components in the square wave, a curve similar to Fig. 27 would be obtained. However, reduction in amplitude of the components is usually caused by a reactive element, causing, in turn, a phase shift of the components, producing tilt as shown in Fig. 26A.

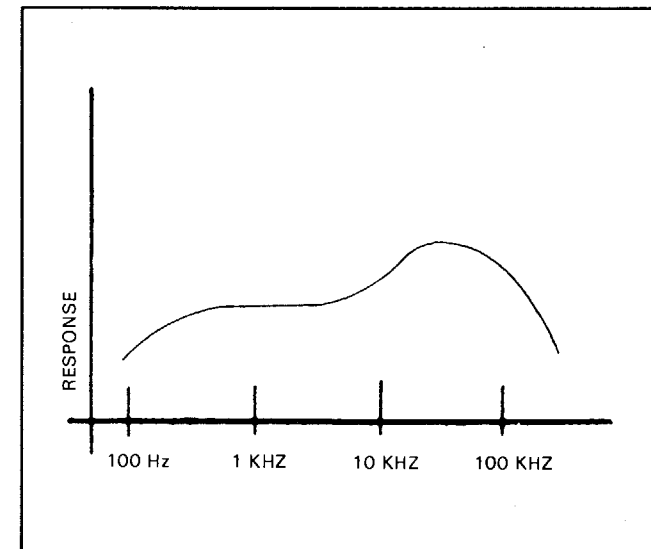

Fig. 25 Response curve of amplifier with poor low and high ends

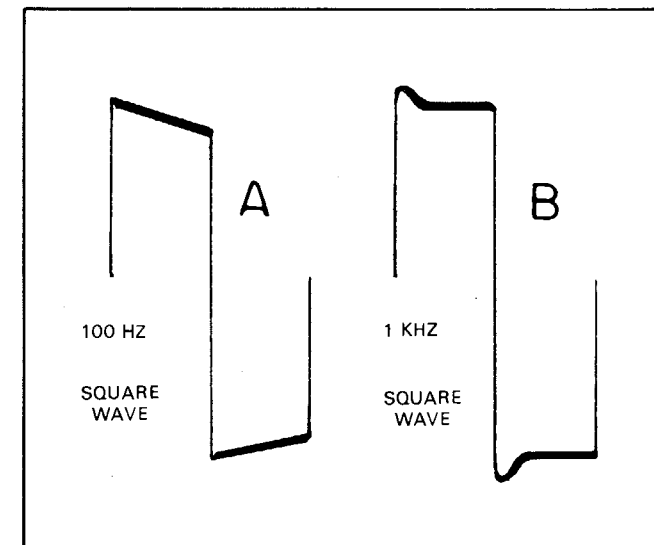

Fig. 26 Resultant 100 Hz and 1 kHz square waves from amplifier in Fig. 25

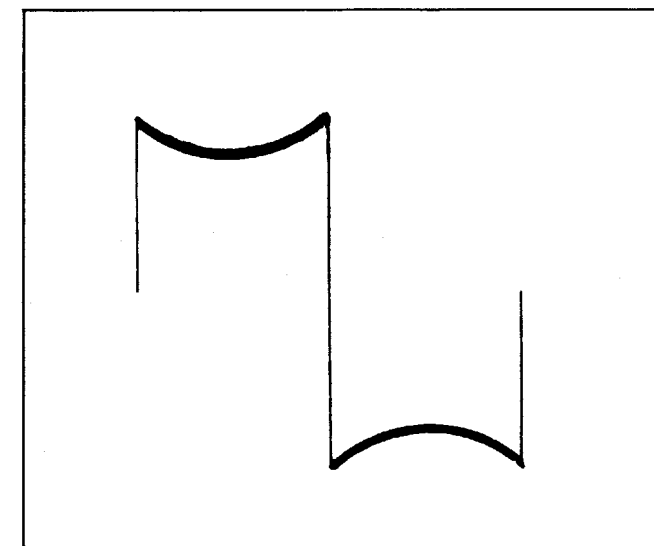

Fig. 27 Reduction of square wave fundamental frequency component in tuned circuit

Testing Procedure (refer to Fig. 23):

1. Connect the output of the square wave generator to the input of the amplifier being tested.
2. Connect the CH2 probe of the oscilloscope to the output of the amplifier.
3. If the DC component of the amplifier output is low, set the AC-GND-DC switch to DC position to allow both the AC and DC components to be viewed. However, the AC position may be used to observe the AC component only, though this will reduce the audio frequency content of less than 5Hz.
4. Adjust the vertical gain controls for a convenient viewing height.
5. Adjust the sweep time controls for one cycle of square wave display on the screen.
6. For a close-up view of a portion of the square wave, use the 5X magnification.

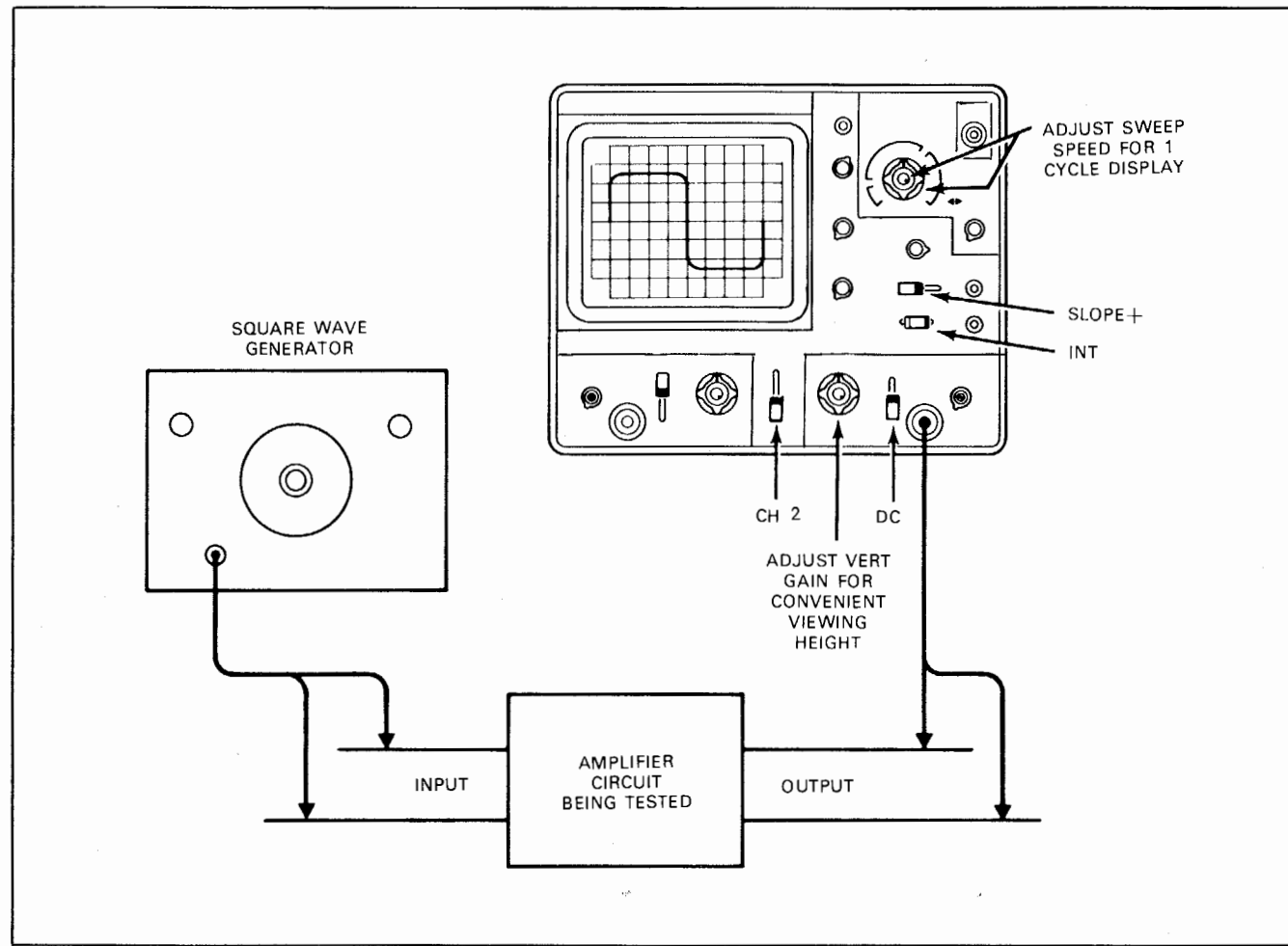

Fig. 23 Equipment set-up for square wave testing of amplifiers

Analysing the Waveforms:

The short rise time which occurs at the beginning of the half-cycle is created by the in-phase sum of the medium and high frequency sine wave components. The same holds true for the drop time. The reduction in high frequency components should produce a rounding of the square corners at all four points of one square wave cycle (see Fig. 24).

Distortion can be classified into the following three categories:

- 1 The first is frequency distortion and refers to the change in the amplitude of a complex waveform. In other words, the introduction in an amplifier circuit of resonant networks or selective filters created by combination of reactive components will create peaks or dips in an otherwise flat frequency response curve.

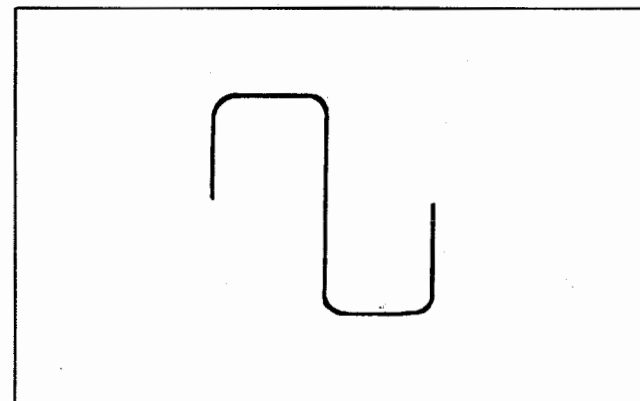

Fig. 24 Square wave response with high frequency loss

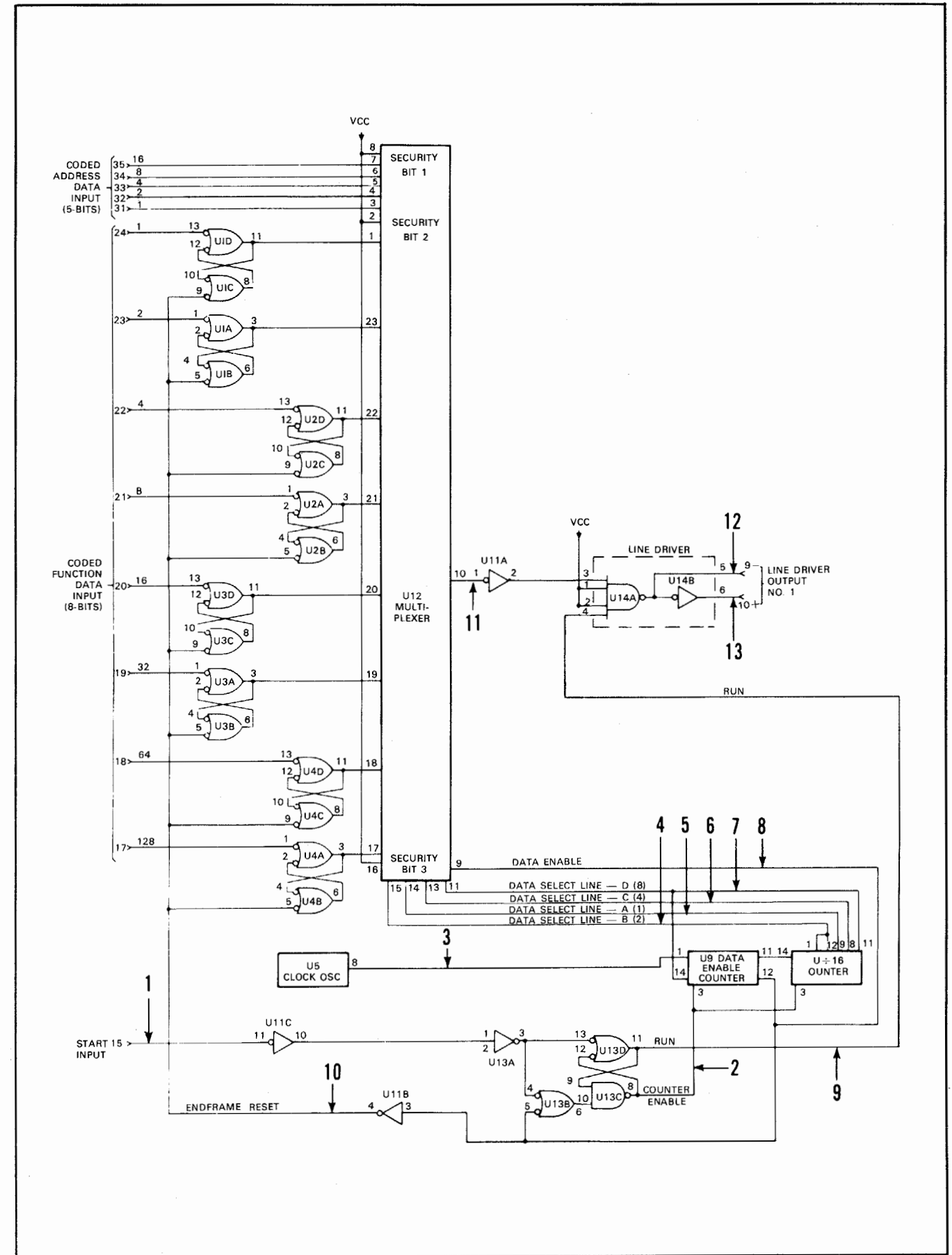

Fig. 5 Typical digital circuit using several time-related waveforms

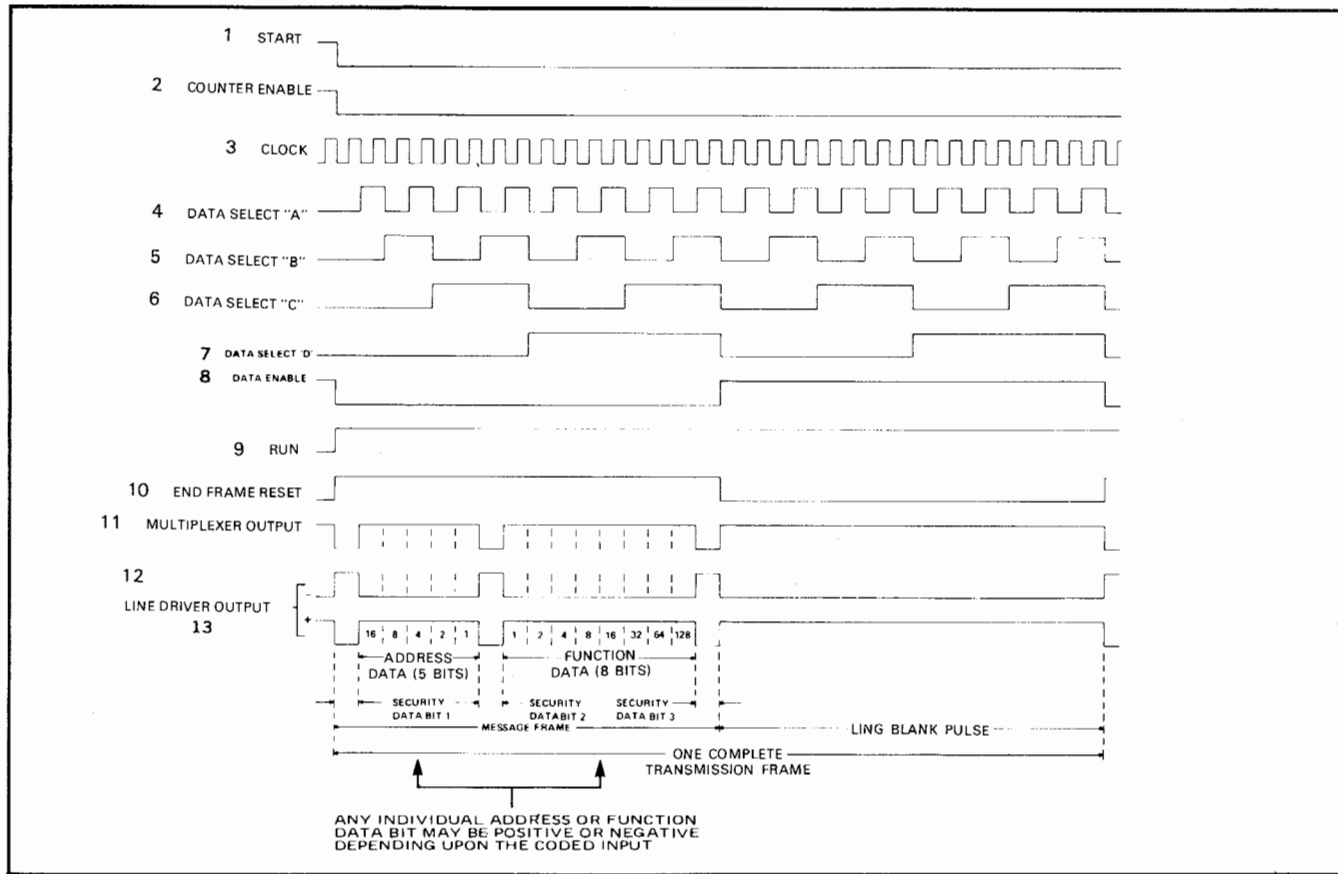

Fig. 6 Family of time-related waveforms from typical digital circuit in Fig. 5

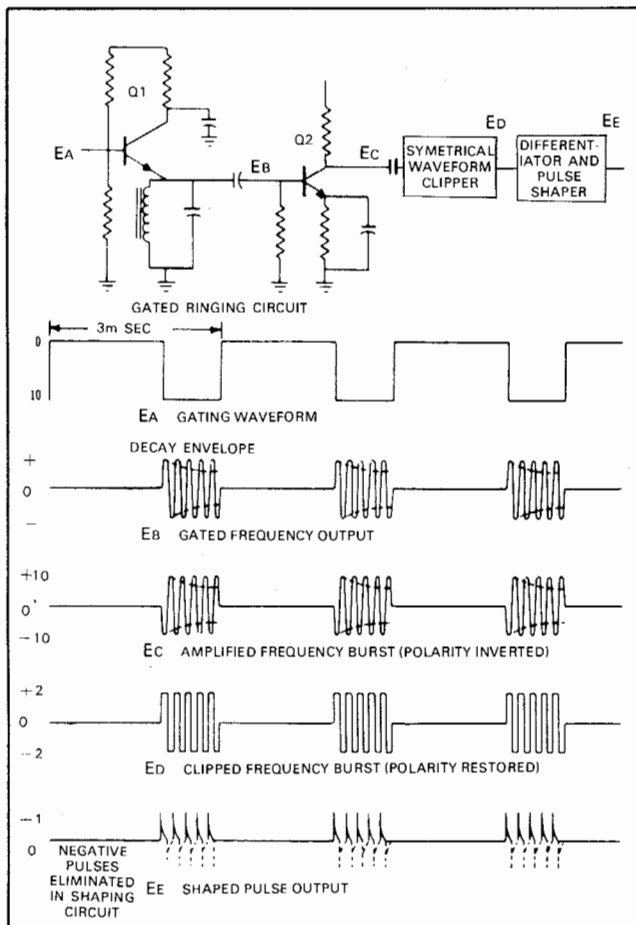

Fig. 7 Gated ringing circuit and waveforms

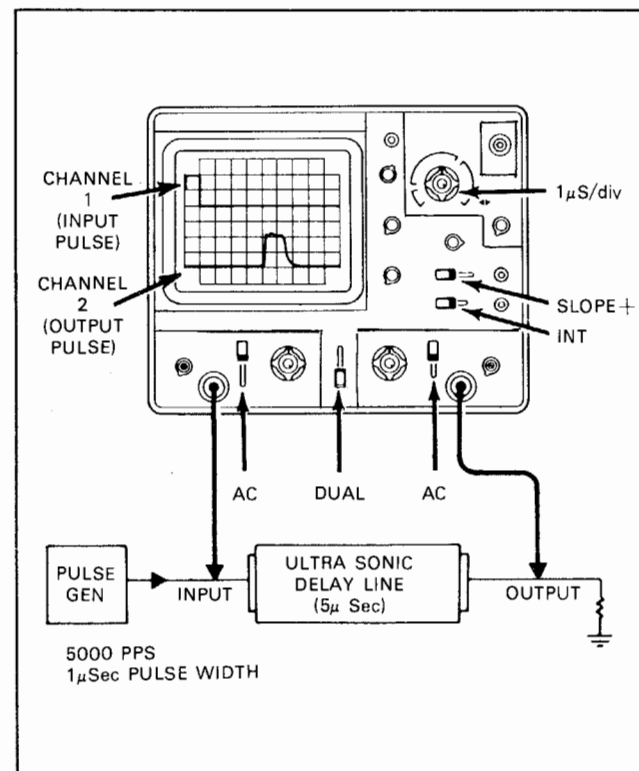

Fig. 8 Delay line measurements

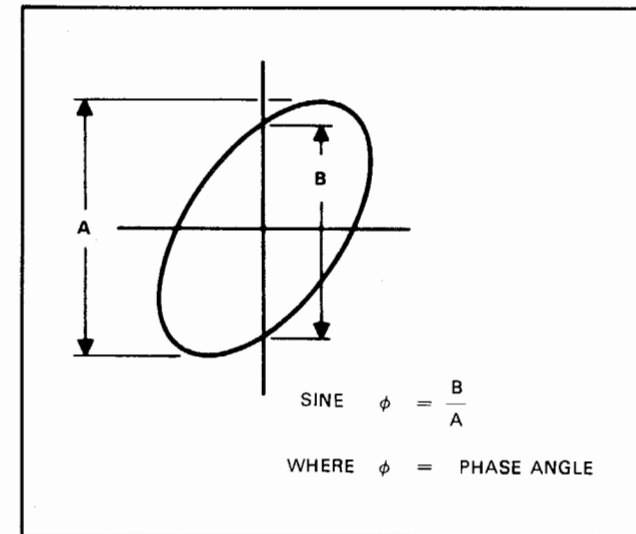

Fig. 21 Phase shift calculation

Frequency Measurement:

1. Connect the sine wave of known frequency to the CH2 input of the oscilloscope and set the SWEEP TIME/DIV control to X-Y.
2. Connect the CH1 probe to the signal to be measured.
3. Adjust the CH1 and CH2 for proper sizes.
4. The resulting Lissajous' pattern shows the ratio between the two frequencies (see Fig. 22).

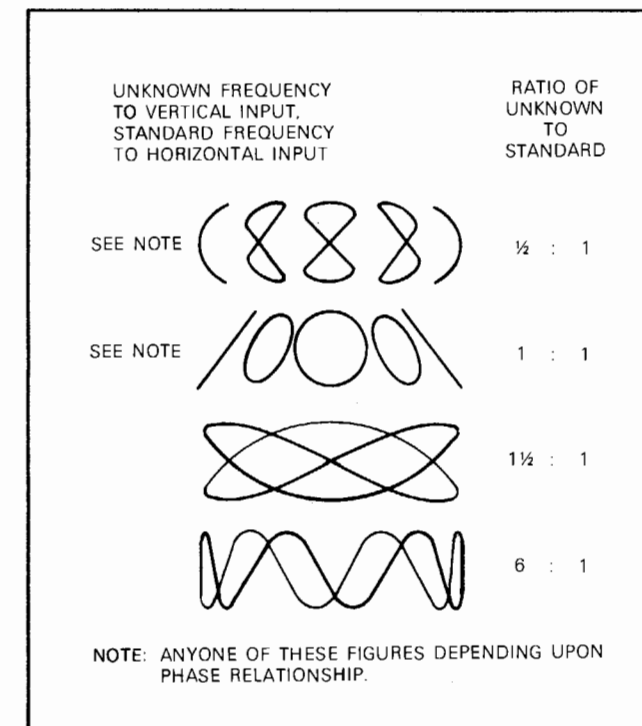

Fig. 22 Lissajous' waveforms used for frequency measurement

AMPLIFIER SQUARE WAVE TEST

Introduction:

A square wave generator and the oscilloscope can be used to display various types of distortion present in electric circuits. A square wave of a given frequency contains a large number of odd harmonics of that frequency. If a 500Hz square wave is injected into a circuit, frequency components of 1.5kHz, 2.5kHz and 3.5kHz are also provided. Since vacuum tubes and transistors are non-linear, it is difficult to amplify and reproduce a square wave which is identical to the input signal. Interelectrode capacitances, junction capacitances, stray capacitances as well as narrow band devices and transformer response are the factors which prevent faithful response of a square wave signal. A well-designed amplifier can minimize the distortion caused by these limitations. Poorly designed or defective amplifiers can introduce distortion to the point where their performance is unsatisfactory.

As stated before, a square wave contains a large number of odd harmonics. By injecting a 500Hz sine wave into an amplifier, we can evaluate amplifier response at 500Hz only, but by injecting a square wave of the same frequency we can determine how the amplifier would respond to input signals from 500Hz up to the 15th or 21st harmonic.

The need for square wave evaluation becomes apparent if we realize that some audio amplifiers will be required during normal use to pass simultaneously a large number of different frequencies. With a square wave, we can evaluate the quality of input and output characteristics of a signal containing a large number of frequency components such as complex waveforms of musical instruments or voices.

The square wave output of the signal generator must be extremely flat. The oscilloscope vertical input should be set to DC as it will introduce the least distortion, especially at low frequencies. Because of the harmonic content of the square wave, distortion will occur before the upper end of the amplifier bandpass.

It should be noted that the actual response check of an amplifier should be made using a sine wave signal. This is especially important in a limited bandpass amplifier such as a voice amplifier.

The square wave signal provides a quick check of amplifier performance and will give an estimate of overall amplifier quality. The square wave also will reveal some deficiencies not readily apparent when using a sine wave signal. Whether a sine wave or square wave is used for testing the amplifier, it is important that the manufacturer's specifications on the amplifier be known in order to make a better judgement of its performance.

X-Y APPLICATIONS

Phase Measurement:

Phase measurements may be made with an oscilloscope. Typical applications are in circuits designed to produce a specific phase shift, and measurement of phase shift distortion in audio amplifiers or other audio networks. Distortion due to non-linear amplification is also displayed in the oscilloscope waveform.

A sine wave input is applied to the audio circuit being tested. The same sine wave input is applied to the vertical input of the oscilloscope, and the output of the tested circuit is applied to the horizontal input of the oscilloscope. The amount of phase difference between the two signals can be calculated from the resulting Lissajous' waveform.

To make phase measurements, use the following procedures (refer to Fig. 19).

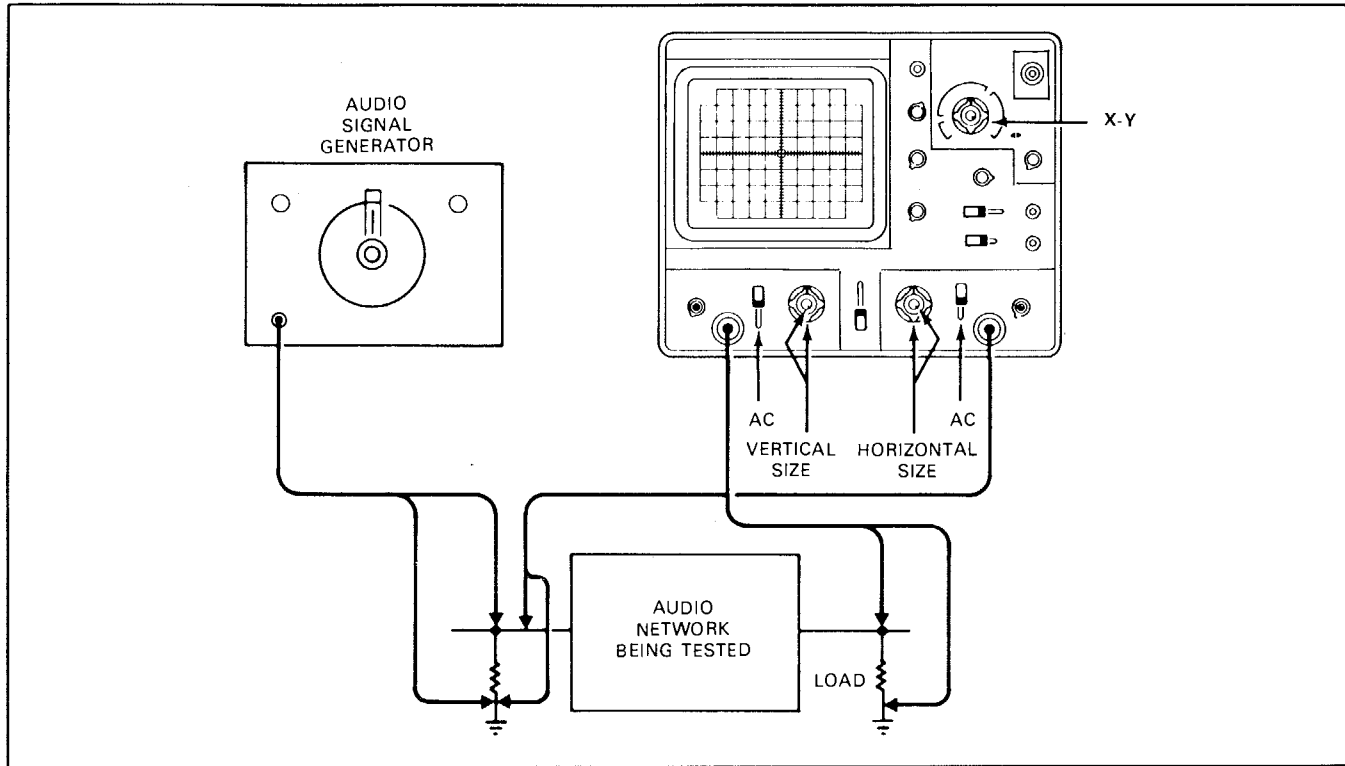

Fig. 19 Typical phase measurement alignment set-up

- Using an audio signal generator with a pure sinusoidal signal, apply a sine wave test signal to the audio network being tested.
- Set the signal generator output for the normal operating level of the circuit being tested. Observe the circuit's output on the oscilloscope and if the test circuit is overdriven, the sine wave display is clipped and the signal level must be reduced.
- Connect the CH2 probe to the output of the test circuit.
- Set the SWEEP TIME/DIV to X-Y.
- Connect the CH1 probe to the input of the test circuit.
- Adjust the CH1 and CH2 gain controls for a suitable viewing size.
- Some typical results are shown in Fig. 20. If the two signals are in phase, the oscilloscope trace is a straight line. If the vertical and horizontal gain are properly adjusted, this line is at 45°. A 90° phase shift produces a circular oscilloscope pattern. Phase shift of less (or more) than 90° produces an elliptical Lissajous' pattern. The amount of phase shift can be calculated by the method shown in Fig. 21.

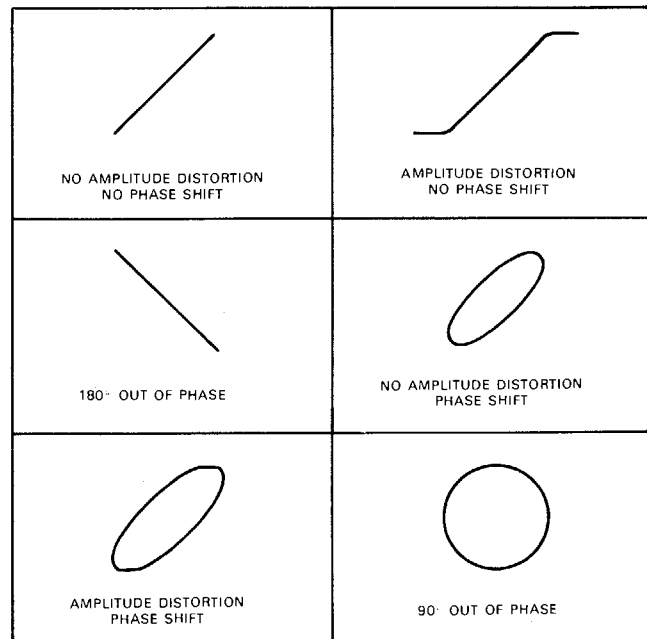

Fig. 20 Typical phase measurement oscilloscope displays

Gated Ringing Circuit(burst circuit):

Fig. 7 shows a burst circuit. The basic settings of control knobs are the same as those in Fig. 4. The waveform A is the reference waveform and is applied to CH1 input. All other waveforms are sampled at CH2 and compared to the reference waveform of CH1. The burst signal can be examined more closely either by increasing the sweep time or by pulling the ◀▶ POSITION control to obtain 5 times magnification.

Delay Line Test:

The dual-trace feature of the oscilloscope can also be used to determine the delay times of transmission type delay lines as well as ultrasonic type delay lines. The output of delay lines is observed on CH2 while being synchronized with the input pulse of CH1. The interval between pulses

should be large compared to the delay time to be observed. In addition to determining delay time, the pulse distortion inherent in the delay line can be determined by examination of the delay pulse observed on CH2 waveform display.

Fig. 8 shows the typical oscilloscope settings as well as the basic test circuit. Typical input and output waveforms are shown on the oscilloscope display. This delay line checking method may also be used for color TV receivers. Fig. 9 shows the oscilloscope settings and typical circuit connections to check the "Y" delay line employed in the video amplifier section. The input waveform and output waveform are compared for delay time, using the horizontal sync pulse of the composite video signal for reference. The indicated delay is approximately one microsecond. In addition to determining the delay characteristics of the line, the output waveform reveals any distortion that may be introduced from an impedance mismatch.

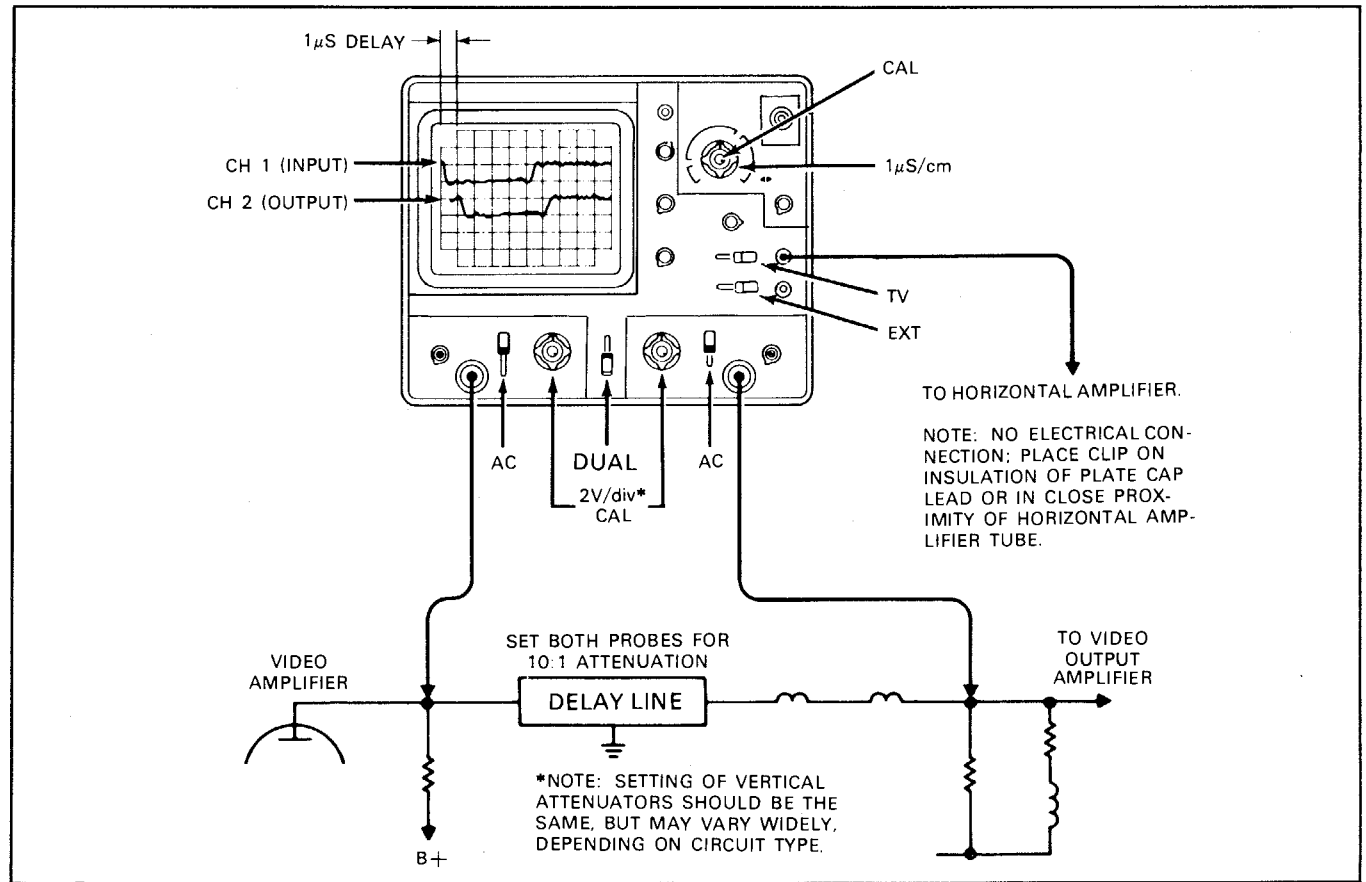

Fig. 9 Checking "Y" delay line in color television receivers

Stereo Amplifier Servicing:

Another convenient use for a dual-trace oscilloscope is in troubleshooting stereo amplifiers. If identical amplifiers are used and the output of one is weak, distorted or otherwise abnormal, the dual-trace oscilloscope can be efficiently used to localize the defect. With an identical sig-

nal applied to the inputs of both amplifiers, a side-by-side comparison of both units can be made by progressively sampling identical signal points in both amplifiers. When the defective or malfunctioning stage has been located, it can be immediately observed and analyzed.

Amplifier Phase Shift Measurements:

In the square wave testing section of this manual, square wave distortion is explained in terms of phase shift of the signal components which comprise the square wave. These phase shifts can be verified directly by providing a sine wave input signal to the amplifier and observing the phase of output signal with respect to the input signal.

In all amplifiers, a phase shift is always associated with a change in amplitude response. For example, at the -3dB response point, a phase shift of 45° occurs. Fig. 10 illustrates a method of determining amplifier phase shift directly. In this case, the measurements are being made at approximately 5000Hz . The input signal is used as a reference and is applied to the Channel 1 input jack.

The VARIABLE control is adjusted as required to

provide a complete cycle of the input waveform displayed on 8div horizontally, while the waveform height is set to 2div. The 8div display represents 360° at the displayed frequency and are centimeter represents 45° of the waveform.

The vertical attenuator controls of Channel 2 are adjusted as required to produce a peak-to-peak waveform of 2 cm. The Channel 2 POSITION control is then adjusted so that the Channel 2 waveform is displayed on the same horizontal axis as the Channel 1 waveform. The distance between the two waveforms then represents the phase shift between the two waveforms. In this case, the zero crossover points of the two waveforms are compared. The illustration shows a phase difference of 1cm which means a phase shift of 45° .

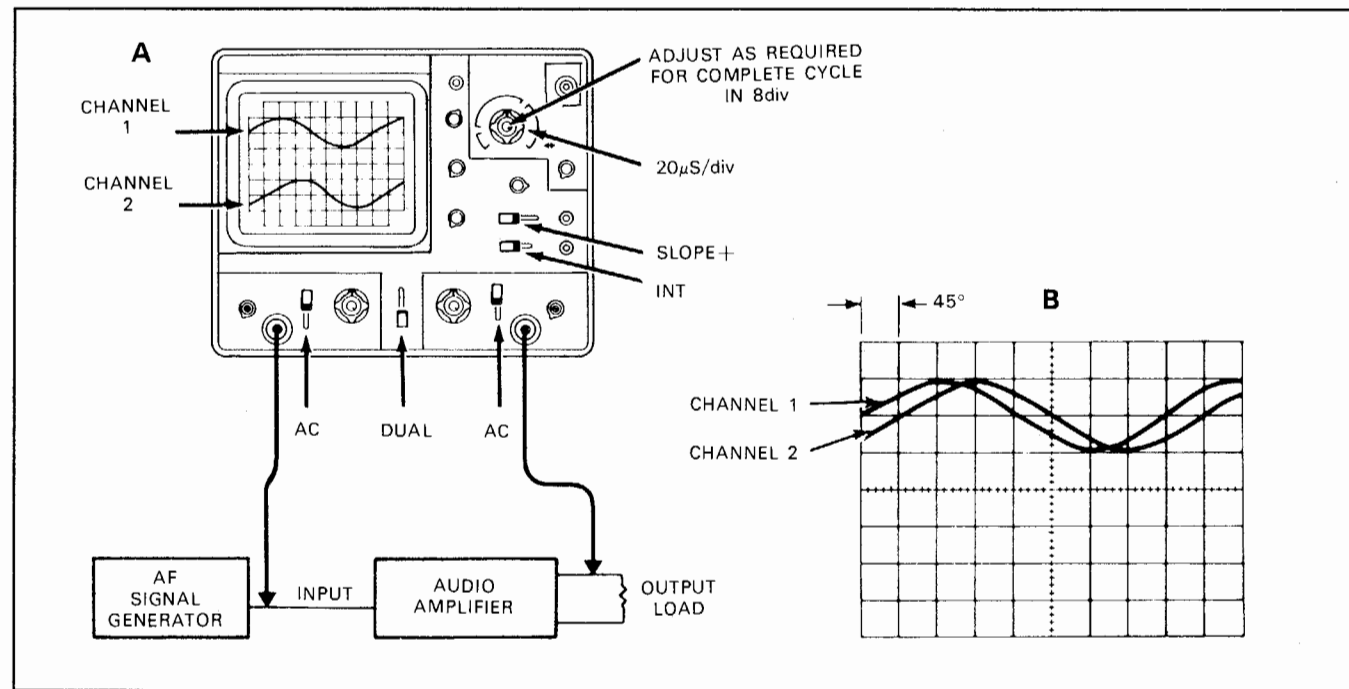

Fig. 10 Measuring amplifier phase shift

Television Servicing:

Many television servicing procedures can be performed using single-trace operation. These are outlined later in the application section covering single-trace operation. One of these procedures, viewing the multi-burst signal in the VITS (vertical interval test signal), can be accomplished more effectively using a dual-trace oscilloscope. The VITS signal is specifically used for characteristic checks of the transmission system of a broadcast station or a network including repeater stations or for changeover of transmission system. In many cases, this signal does not appear in the normal video signals. Even when it is included in the signal, the method of inserting the information differs depending on the broadcast station. Also, the VITS information in Field 1 (1st interlaced scanning) and Field 2 (2nd interlaced scanning) are different in many cases. Examples of VITS signals are shown in Fig. 11.

Because the oscilloscope sweep is synchronized to the

vertical blanking signal, the waveform of Field 1 cannot be distinguished from that of Field 2. This causes the VITS signals to be superimposed onto each other, resulting in difficulty in viewing. With dual-trace operation using the same input, the waveform can be viewed separately without overlapping because of the effects of the oscilloscope's alternate sweep operation and interlaced scanning of TV signal.

The possibility of viewing VITS signals provides an important role in servicing TV sets. This VITS signal can localize trouble in the antenna, tuner, IF or video sections and shows when realignment may be required. The following procedures show how to analyze and interpret oscilloscope displays of the VITS.

The VITS is transmitted during the vertical blanking interval. On the television set, it can be seen as a bright white line above the top of the picture, when the vertical linearity or height is adjusted to view the vertical blanking interval (on TV sets with internal retrace blanking circuits, the blanking circuits must be disabled to see the VITS).

CIRCUIT DEFECT	HORIZONTAL PULSE DISTORTION	OVERALL RECEIVER FREQUENCY RESPONSE	EFFECT ON PICTURE
NORMAL CIRCUIT			PICTURE NORMAL
LOSS OF HIGH FREQUENCY RESPONSE			LOSS OF PICTURE DETAIL
EXCESSIVE HIGH FREQUENCY RESPONSE NON-LINEAR PHASE SHIFT			FINE VERTICAL BLACK AND WHITE STRIATIONS FOLLOWING A SHARP CHANGE IN PICTURE SHADING
LOSS OF LOW FREQUENCY RESPONSE			CHANGE IN SHADING OF LARGE PICTURE AREAS, SMEARED PICTURE

Fig. 16 Analysis of sync pulse distortion

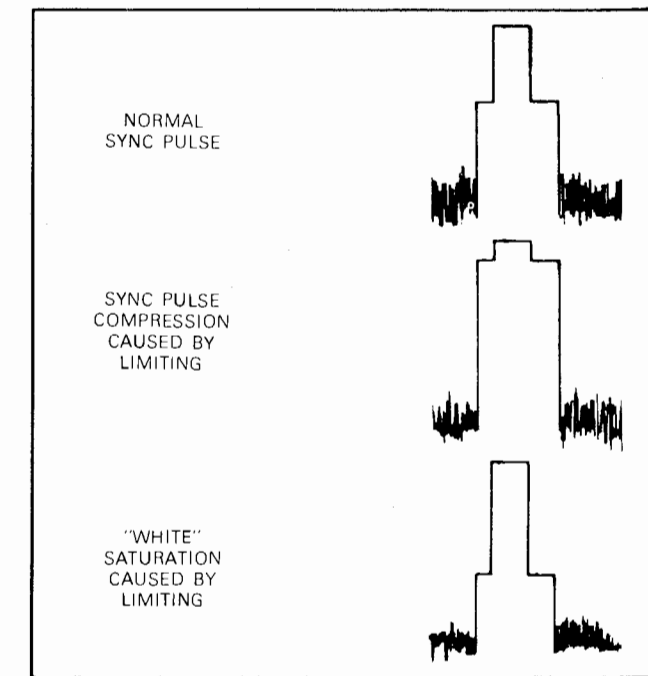

Fig. 17 Sync pulse waveforms

FM RECEIVER ADJUSTMENTS

1. Connect a sweep generator to the mixer input of the FM receiver. Set the sweep generator for a 10.7MHz center sweep.
2. Connect the sweep voltage output of the sweep generator to the Channel 2 input jack of the oscilloscope and set the oscilloscope controls for external horizontal sweep (SWEEP TIME/DIV to X-Y).
3. Connect the vertical input probe to the demodulator input of the FM receiver.
4. Adjust the oscilloscope vertical and horizontal gain controls for display similar to that shown in Fig. 18A.
5. Set the marker generator precisely to 10.7MHz . The marker "pip" should be in the center of the bandpass.

6. Align the IF amplifiers according to the manufacturer's specifications.
7. Move the probe to the demodulator output. The "S" curve should be displayed, and the 10.7MHz "pip" should appear in the center (see Fig. 18B.) Adjust the demodulator according to the manufacturer's instructions so the marker moves an equal distance from the center as the marker frequency is amplified an equal amount from the 10.7MHz center frequency.

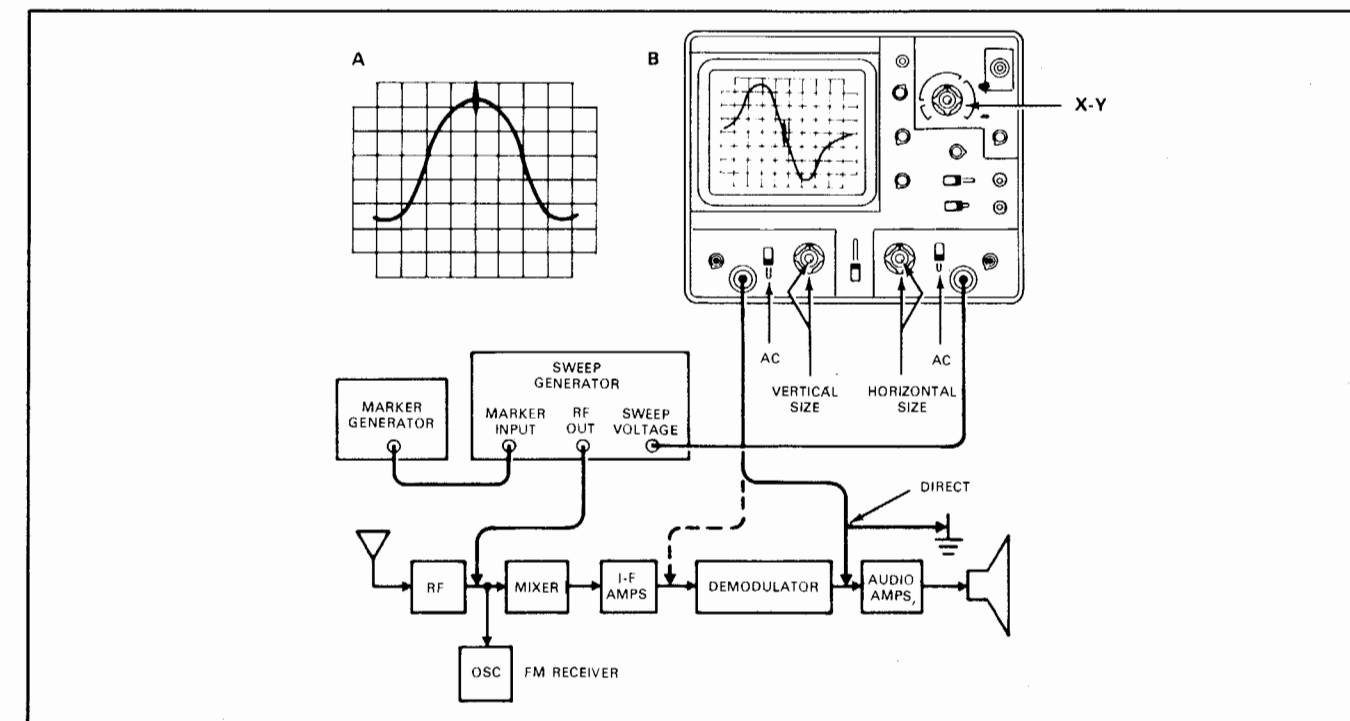

Fig. 18 Typical FM receiver alignment set-up

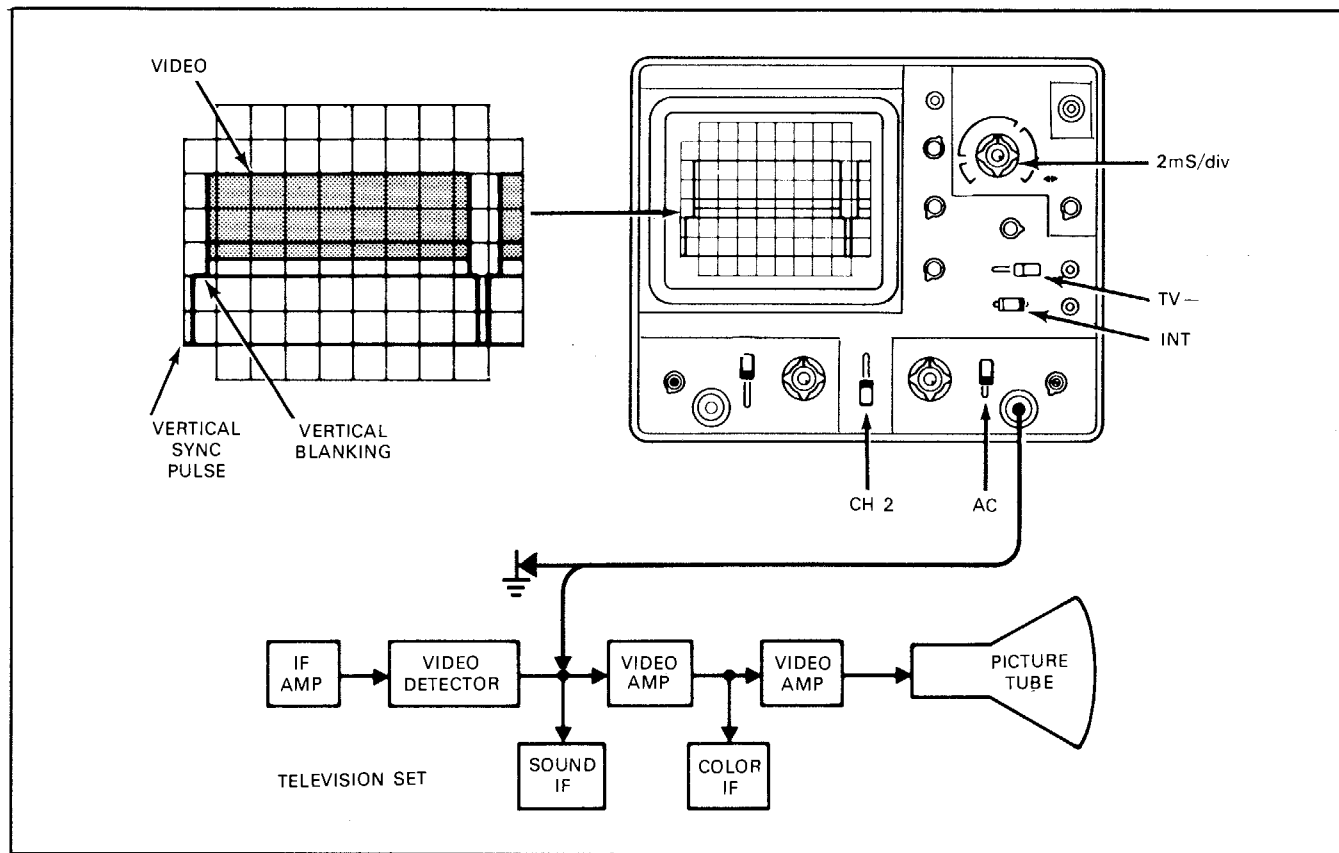

Fig. 15 Set-up for viewing vertical fields of composite video signal

To set up the oscilloscope for viewing composite video waveforms, use the following procedures:

1. Tune the television set to a local channel.
2. Set the MODE switch to CH2 position.
3. Set the SWEEP TIME/DIV switch to the $10\mu\text{s}/\text{div}$ position for observing TV horizontal lines or to the $2\text{ms}/\text{div}$ position for observing TV vertical frames.
4. Set the SYNC switch to the TV+ position.
5. Set the SOURCE switch to the INT position.
6. Set the TRIGGERING LEVEL control to the AUTO position.
7. Set the CH2 DC-GND-AC switch to the AC position.
8. Connect a probe cable to the CH2 INPUT jack. Connect the ground clip of the probe to the television set chassis.
9. With the probe set to 10 : 1 attenuation, connect the tip of the probe to the video detector output of the television set.
10. Set the CH2 VOLTS/DIV switch for the largest vertical deflection possible without going off-scale.
11. Rotate the TRIGGERING LEVEL control to a position that provides a synchronized display.
12. Adjust the sweep time VARIABLE for two horizontal lines or two vertical frames of composite video display.
13. If the sync and blanking pulses of the displayed video signals are positive, set the SYNC switch to the TV+ position; if the sync and blanking pulses are negative, use the TV- position.

13. Push in the TRIGGERING LEVEL control and rotate to a position that provides a well synchronized display.
14. Adjust the INTENSITY and FOCUS controls for the desired brightness and best focus.
15. To view a specific portion of the waveform, such as the color burst, pull the \blacktriangleleft POSITION control for X5 magnification. Rotate the same control left or right to select the desired portion of the waveform to be viewed.
16. The polarity of the observed waveform may be reversed when moving from one monitoring point to another; therefore, it may be necessary to reverse the polarity of the SYNC switch.

Sync Pulse Analysis:

The IF response of a television receiver can be evaluated to some extent by careful observation of the horizontal sync pulse waveform. The appearance of the sync pulse waveform is affected by the IF amplifier bandpass characteristics. Some typical waveform symptoms and their relation to IF amplifier response are indicated in Fig. 16. Sync pulse waveform distortions produced by positive or negative limiting in IF overload conditions are shown in Fig. 17.

The transmitted VITS has a specific frequency, amplitude and waveform as shown in Fig. 11. Television networks use precise signals for adjustment and checking of network transmission equipment, but the multi-burst signal in VITS can also be used for checking the operating condition of TV sets. The first frame of VITS at the "B"

section (line 18) in Fig. 11 begins with a white reference signal, followed by sine wave frequencies of 0.5 MHz, 1.0 MHz, 2 MHz, 3 MHz, 4.0 MHz and 3.58 MHz. This sequence of frequencies is called a "multi-burst" which is very useful.

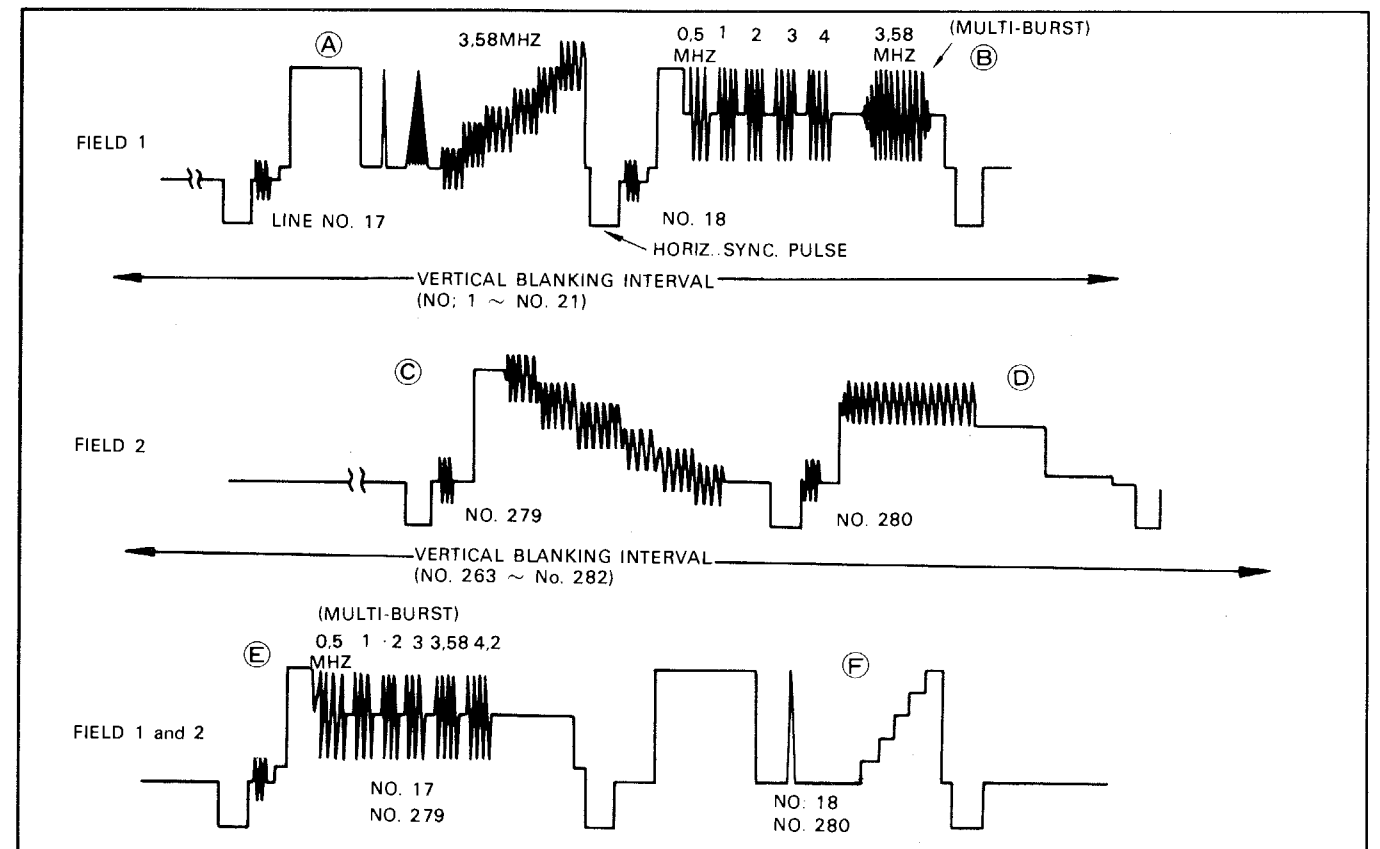

Fig. 11 VITS signal, Fields 1 and 2

The VITS other than the multi-burst signal is different depending on broadcast station. VITS staircase waveform containing a 3.58 MHz burst signal is valuable to the network, but has less value to the service technician. As Field 1 is interlaced with Field 2, line 17 is followed by line 279 and line 18 is followed by line 280. The entire VITS appears at the bottom of the vertical blanking pulse and just before the first line of the video signal.

Each of the multi-burst frequencies is transmitted at equal strength. By observing the comparative strengths of these frequencies after the signal is processed through the television receiver, the frequency response of the set can be checked.

All multi-burst frequencies are transmitted at the same level, but will appear as shown in Fig. 12 even on a good color television set, due to its response curve; showing the allowable amount of attenuation for each multi-burst frequency. Remember that -6 dB equals half the reference voltage (the 2.0 MHz modulation should be used for reference).

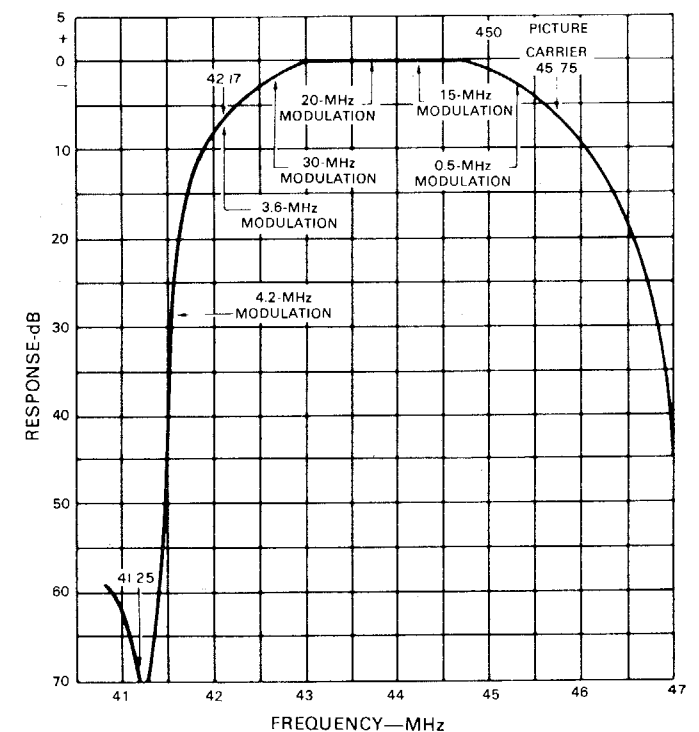

Fig. 12 Color TV IF amplifier response curve

To localize trouble, start by observing the VITS at the video detector. This will localize trouble to a point either before or after the detector. If the picture quality of each channel is different, the trouble is in the tuner or antenna system. If the picture quality is the same for all channels but the multi-burst is abnormal, then the trouble may be in the IF stage.

As another example, let us assume that we have a set on the bench with a very poor picture. Our oscilloscope shows the VITS at the video detector to be about normal ex-

cept that the burst at 2.0MHz is low compared to other burst signals. This suggests the IF trap is detuned into the passband, chopping out frequencies about 2 MHz below the picture carrier frequency. Switch to another channel, if the amplifier requires realignment. If the picture quality is the same, then our reasoning is right, and if the picture quality of another channel is normal, the FM trap at the tuner input is misadjusted. Fig. 13 shows the method of viewing the VITS waveforms.

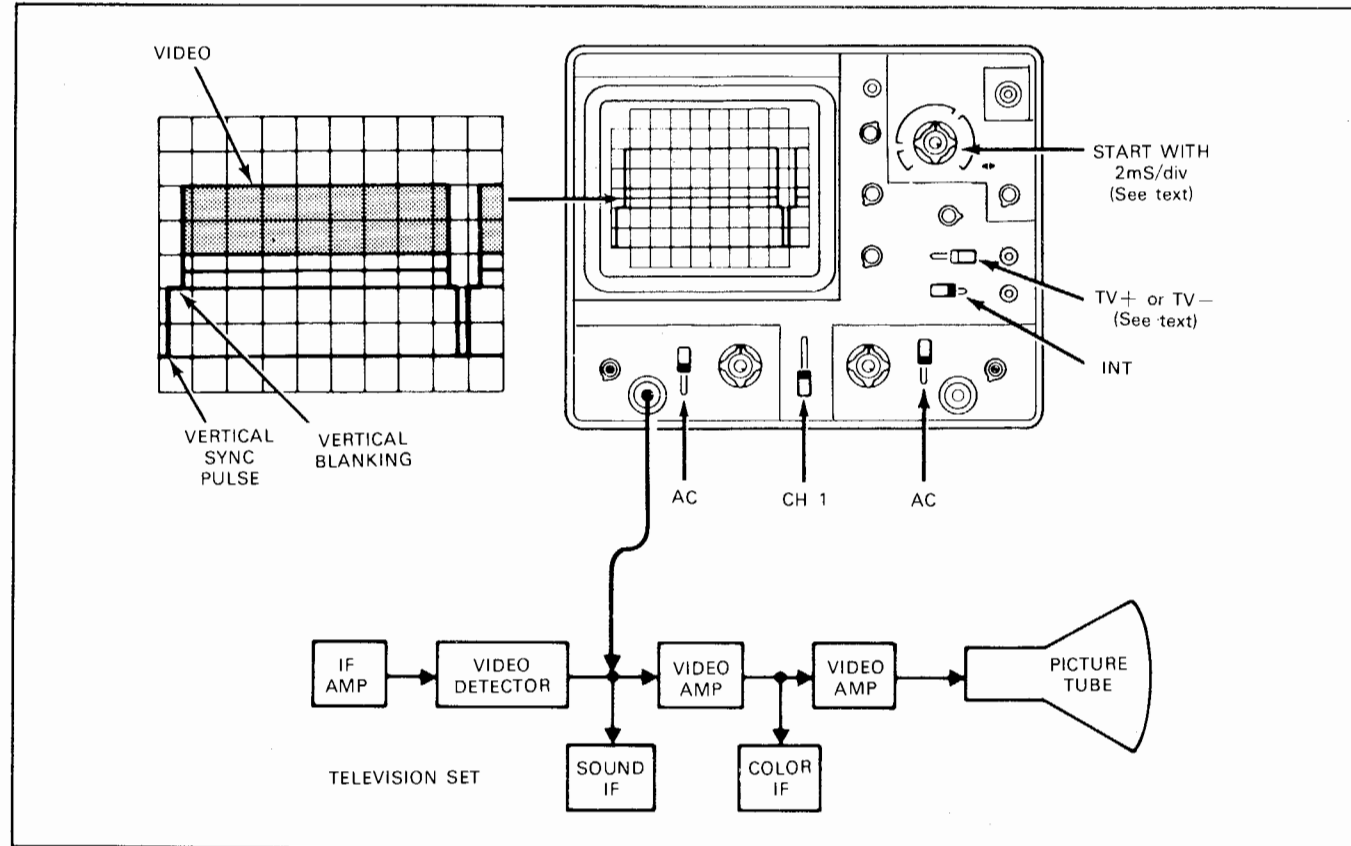

Fig. 13 Set-up for viewing fields 1 and 2 of VITS information

1. Set a color TV receiver to the station transmitting color signals containing VITS.
2. The method shown in Fig. 13 is used to obtain Field 2 vertical signal on CH1.
3. Set the oscilloscope and the receiver for operation. Connect the CH1 probe (set at 10 : 1) to the test point of video detector or other desired test point in the video section of the television receiver.
4. Set the SYNC switch as follows:
 - A. If the sync and blanking pulses of the observed video signal are positive, use the TV+ switch position in.
 - B. If the sync and blanking pulses are negative, use the TV- switch position out.
5. Adjust the sweep time VARIABLE control so that 2 vertical fields are displayed on the oscilloscope screen.
6. Connect the CH2 probe (set to 10 : 1) to the same test point as does the CH1 probe.
7. Set the MODE switch to DUAL position.
8. Place the sweep time VARIABLE in the CAL position.
9. Set the SWEEP TIME/DIV control to the 0.1ms/div position to expand the display. The VITS information will appear toward the right hand portion of the expanded waveform displays. The waveform information on each trace may appear as shown in Fig. 11. Because there is no provision for synchronizing the oscilloscope display to either of the two fields which comprise a complete vertical frame, it cannot be predicted which field display will appear on CH1 or CH2.
10. Pull the ◀▶ POSITION control outward to obtain an additional X5 magnification. Rotate the control moving the trace to the left until the expanded VITS information appears as shown in Fig. 11. Because of the low repetition rate and the high sweep speed combination, the brightness level of the signal displays will be reduced.
11. Once the CH1 and CH2 displays have been identified

as being either Field 1 or Field 2 VITS information, the probe corresponding to the waveform display can be used for signal-tracing and troubleshooting, and the remaining probe should be left at the video detector test point to ensure that the sync signal is not interrupted. If the sync signal is interrupted, the waveform displays may be reversed because, as previously explained, there is no provision in the oscilloscope to identify either of the two vertical fields which comprise a complete frame.

SINGLE-CHANNEL APPLICATIONS

Introduction:

In addition to the dual-trace applications previously outlined, there are, of course, many servicing and laboratory applications where only single-trace or single-channel operation of the oscilloscope is required.

Television Servicing:

A triggered sweep oscilloscope is advantageous in servicing and aligning television receivers. This oscilloscope also includes several features that were incorporated to make television servicing easier and more comprehensive.

- * With the SYNC switch set to TV position, the SWEEP TIME/DIV control automatically selects the TV vertical sync at sweep speeds appropriate for viewing frames and TV horizontal sync at sweep speeds appropriate for viewing lines.
- * Wide bandwidth for high resolution video and high speed pulse presentation.

Single-trace Operation and Peak-to-peak Voltage Readings:

For general troubleshooting and isolation of troubles in television receivers, the oscilloscope is an indispensable instrument. It provides a visual display of the absence or presence of normal signals. This method (signal-tracing) may be used to trace a signal by measuring several points in the signal path. As measurements proceed along the signal path, a point may be found where the signal disappears. When this happens, the source of trouble has been located.

However, the oscilloscope shows much more than the mere presence or absence of signal. It provides a peak-to-peak voltage measurement of the signal as well as presentation of waveforms. The schematic diagram or accompanying service data on the equipment being serviced usually includes waveform diagram. These waveform diagram include the required sweep time and the normal peak-to-peak voltage. Compare the peak-to-peak voltage readings on the oscilloscope with those shown on the waveform diagram.

Composite Video Waveform Analysis:

Probably the most important waveform in television servicing is the composite waveform consisting of the video signal, the blanking pedestal signal and the sync pulses. Fig. 14 and Fig. 15 show typical oscilloscope traces when observing composite video signals synchronized with horizontal sync pulses and vertical blanking pulses. Composite video signals can be observed at various stages of the television receiver to determine whether circuits are performing normally. Knowledge of waveform makeup, the appearance of a normal waveform, and the causes of various abnormal waveforms help the technician locate and correct many problems. The technician should study such waveforms in a television receiver known to be in good operating condition, noting the waveform at various points in the video amplifier.

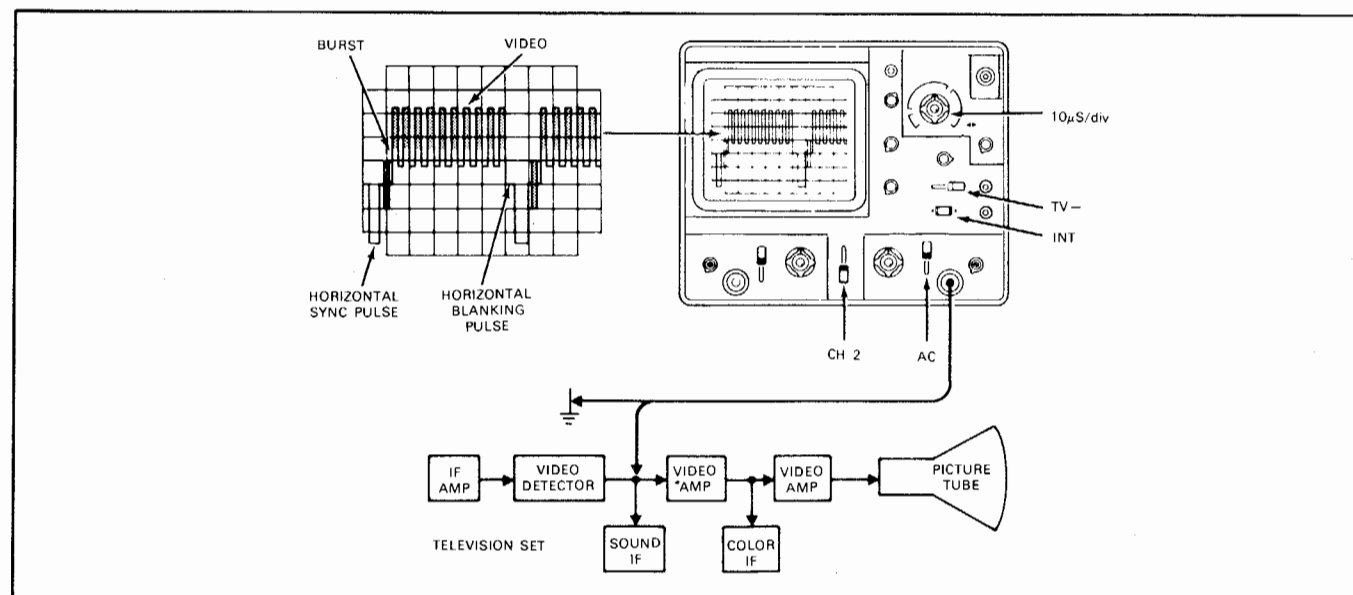

Fig. 14 Set up for viewing horizontal fields of composite video signal