

TRIGGERED SWEEP OSCILLOSCOPE

HIGH STABILITY

CS-1577A

DUAL TRACE OSCILLOSCOPE

INSTRUCTION MANUAL

 **TRIO**

Este manual original foi gentilmente cedido para ser digitalizado por PY2TKI Marcos
Digitalizado em 01 de Dezembro de 2020 por Alexandre "Tabajara" Souza, PU2SEX

<http://www.tabalabs.com.br>

<http://tabajara-labs.blogspot.com>

MANUAL DE DISTRIBUIÇÃO GRATUITA - Respeite o meu esforço de preservar a documentacao

CONTENTS

	Page
FEATURES	2
SPECIFICATIONS	2
Front Panel	4
Side Panel	6
Rear Panel	7
OPERATION	8
Preliminary Operation	8
Operating Procedures	8
Triggering	9
APPLICATIONS	12
Dual-trace Applications	12
Single-channel Applications	21
FM Receiver Adjustments	23
X-Y Operation	24
Amplifier Square Wave Test	26
PRECAUTIONS	31
MAINTENANCE AND ADJUSTMENT	31
Maintenance	31
Adjustment	32
SCHEMATIC DIAGRAM	35

FEATURES

- * Vertical axis with wide bandwidth (35MHz, -3dB) and high sensitivity (2mV/div, 1 div=9.5 mm).
- * Single sweep function for one-shot trace observation.
- * Fix sync function for automatic synchronization of varied waveforms.
- * The adoption of signal delay circuit permits observation of the rising characteristic of high speed pulses.
- * Hold-off control system for stabilized synchronization of complex waveforms.
- * Easy correction of horizontal trace angle with unique trace rotation system.
- * The CRT has a rectangular with internal graticule, post-deflection accelerator with domed mesh to eliminate parallax errors.
- * Dotted line indicate 0%, 10%, 90% and 100% of measuring lattice for measurement of rise time.
- * X-Y changeover systems allows CH1 amplifier to be used as X axis amplifier and CH2 amplifier as Y axis amplifier.
- * CHOP and ALT are interlocked with time base switch to permit automatic changeover. Observation during CHOP operation is also possible.
- * Auto free-run system enables the trace to be checked even at no-signal time.
- * Sync coupling for AC, LF Rej, HF Rej, VIDEO and DC to provide stable synchronization.
- * VIDEO-FRAME, VIDEO-LINE selection of VIDEO sync separation circuit is automatically effected by the interlocked time base switch.
- * UNCAL lamp is ON when vertical sensitivity or sweep time is not being calibrated. TRIG lamp is ON during trigger sweep.
- * The adoption of ICs throughout circuitry provides high performance and improved reliability.

SPECIFICATIONS

Cathode Ray Tube

Type:	140CGB31 (Rectangular CRT, internal graticule)
Accelerating voltage:	Approx. 6kV
Scale:	8 div x 10 div (1 div=9.5mm)

Vertical Amplifiers (for both CH1 and CH2)

Deflection Factor:	2mV/div - 10V/div $\pm 3\%$, at 10 - 30°C, $\pm 5\%$, at 0-40°C
Attenuator:	2 mV/div to 10V/div in 12 calibrated ranges in 1-2-5 sequence. Variable between ranges, $\pm 5\%$ on all ranges
Input impedance:	1M $\Omega \pm 2\%$ Approx. 22pF
Frequency response:	DC DC-35MHz (-3dB) AC 5Hz-35MHz (-3dB)
Risetime:	Less than 10 nsec.
Over-shoot:	Less than 3% (at 100kHz square wave)
Cross-talk:	ALT: -60dB CHOP: -40dB } (at 1 kHz)
Operating modes:	CH1 CH1 only CH2 CH2 only DUAL 2-channel ADD CH1 + CH2 X-Y X axis: CH2 Y axis: CH1

Dual-trace changeover: ALT is effected when TRIG SOURCE is in ALT or NORM-CHOP is in NORM and SWEEP TIME/DIV is 0.5ms/div - 0.1 μ s/div. CHOP is effected (about 350kHz switching) in other modes.

Invert polarity: CH2 only
Maximum input voltage: 500Vp-p or 250V (DC + AC peak)
Signal delay time: Approx. 10 nsec. (on CRT screen)

Horizontal Amplifier (CH2 input)

Operating modes: X-Y changeover with vertical MODE switch
CH1 Y axis
CH2 X axis

Deflection Factor: Same as vertical (CH1)
Input impedance: Same as vertical (CH1)
Frequency response: DC DC-2MHz (-3dB), 3MHz (-6dB)
AC 5Hz-2MHz (-3dB), 3MHz (-6dB)

X-Y phase difference: Less than 3° at 100kHz

Sweep Circuit

Sweep system: SINGLE Single sweep
 NOR Triggering sweep
 AUTO Triggering sweep and auto free-run sweep at no-signal time.
 FIX Automatically fixes levels at center of trigger signal.

Sweep time: 0.1 μ s/div to 0.5 s/div in 21 calibrated ranges, in 1-2-5 sequence. Variable between ranges, Sweep time accuracy; $\pm 3\%$

Magnifier: 5 times $\pm 5\%$
Linearity: Better than $\pm 3\%$ (10% at X5 MAG)

Triggering

Source (Internal): ALT
 CH1
 CH2
Source (External): EXT 1/10
 EXT 1

External triggering input voltage: 50V (DC + AC peak)
Type: SINGLE, NORM, AUTO Manual sync
 FIX Auto sync

Slope: Positive or negative
Coupling: AC, LF Rej, HF Rej, VIDEO, DC
 LINE and FRAME are automatically switched by SWEEP TIME/DIV
 LINE (VIDEO – Line):
 0.1 μ s/div \sim 50 μ s/div
 FRAME (VIDEO – Frame):
 0.1ms/div \sim 0.5s/div

Sensitivity:

Triggering Mode in SINGLE or NORM

Coupling	Bandwidth (Hz)	Minimum Sync Voltage		
		INT (div)	EXT 1/10 (Vp-p)	EXT1 (Vp-p)
AC	50 ~ 15M	0.5	3	0.3
	10 ~ 40M	0.8	3	0.3
VIDEO	VIDEO	1	5	0.5
DC	DC ~ 15M	0.5	3	0.3
	DC ~ 40M	0.8	3	0.3

HF REJ: Attenuate above 100 kHz
LF REJ: Attenuate below 10 kHz

TRIGGERING MODE	Bandwidth (Hz)	Minimum Sync Voltage		
		INT (div)	EXT 1/10 (Vp-p)	EXT1 (Vp-p)
AUTO	100 ~ 15M	0.5	3	0.3
	50 ~ 40M	0.8	3	0.3
FIX	100 ~ 15M	0.5	3	0.3
	50 ~ 40M	0.8	3	0.3

HOLDOFF: NORM-MAX (Continuous variability more than ten times)

Calibrating voltage: 0.1Vp-p $\pm 3\%$, positive polarity, reference level 0V (1kHz $\pm 3\%$)

Intensity Modulation

Input voltage: TTL level (more than 2.5Vp-p)
Input impedance: 12k Ω
Bandwidth: DC-5MHz
Maximum input voltage: 50V (DC + AC peak)

Trace rotation: Trace angle is adjustable by panel surface adjuster.

Power Requirements

Power supply voltage: AC 100/117/220/240V $\pm 10\%$, 50/60Hz
Power consumption: Less than 45W

Dimensions: Width 260mm (277mm)
 Height 190mm (204mm)
 Depth 375mm (440mm)
 Width 260mm (260mm)

Weight: CS-1577A 9.1kg

Accessories: Probe (PC-22) 2
 Attenuation 1/10
 Input impedance 10M Ω , 18pF or less
 Instruction manual 1
 Replacement fuse:
 0.5A 2
 0.8A 2

CONTROLS ON PANELS

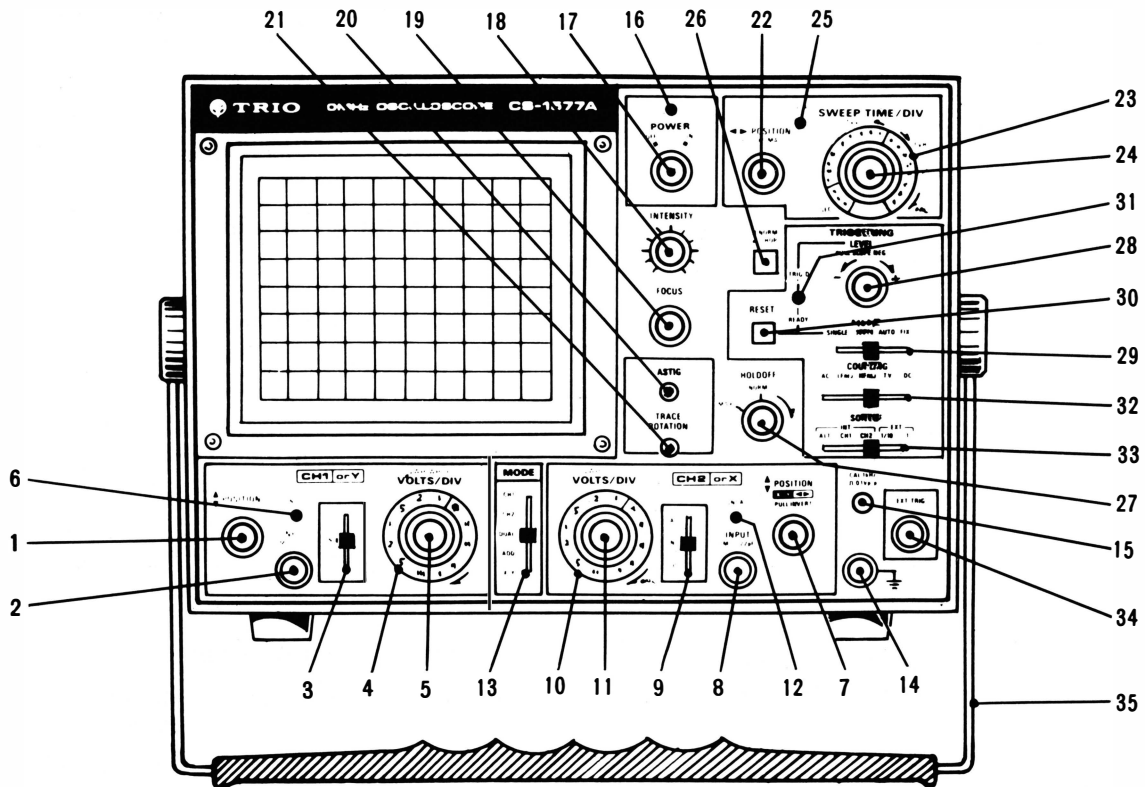

CONTROLS ON FRONT PANEL

1. ▲ POSITION

Rotation adjusts vertical position of channel 1 trace. In X-Y operation, rotation adjusts vertical position of display.

2. INPUT

Vertical input terminal for CH1, and Y input terminal for X-Y operation.

3. AC-GND-DC

Three-position lever switch which operates as follows:

- AC:** Blocks dc component of channel 1 input signal.
- GND:** Opens signal path and grounds input to vertical amplifier. This provides a zero-signal base line, the position of which can be used as a reference when performing dc measurements.
- DC:** Direct input of ac and dc component of channel 1 input signal.

4. VOLTS/DIV

Vertical attenuator for channel 1 provides step adjustment of vertical sensitivity. When VARIABLE control (5) is set to CAL, vertical sensitivity is calibrated in 12 steps from 10 V/div to 2 mV/div.

5. VARIABLE

Rotation provides fine control of channel 1 vertical sensitivity. In the fully clockwise (CAL) position, the vertical attenuator is calibrated.

6. UNCAL Lamp

Glows when channel 1 VARIABLE control (5) is not set to CAL position. Reminds user that channel 1 measurements are not calibrated.

7. POSITION, X-Y , PULL INVERT

Vertical position adjustment for channel 2 trace. Becomes horizontal position adjustment when MODE switch (13) is in X-Y position. Push-pull switch selects normal or inverted polarity of channel 2 display (PULL INVERT).

8. INPUT

Vertical input terminal for CH2 or X input terminal for X-Y operation.

9. AC-GND-DC

Three-position lever switch which operates as follows:

AC: Blocks dc component of channel 2 input signal.

GND: Opens signal path and grounds input to vertical amplifier. This provides a zero-signal base line, the position of which can be used as a reference when performing dc measurements.

DC: Direct input of ac and dc component of channel 2 input signal.

10. VOLTS/DIV

Vertical attenuator for channel 2; provides step adjustment of vertical sensitivity. When VARIABLE control (11) is set to CAL, vertical sensitivity is calibrated in 12 steps from 10V/div to 2 mV/div. In X-Y operation, this control provides step adjustment of horizontal sensitivity.

11. VARIABLE

Rotation provides fine control of channel 2 vertical sensitivity. In the fully clockwise (CAL) position, the vertical attenuator is calibrated. In X-Y operation, this control becomes the fine horizontal gain control.

12. UNCAL Lamp

Glowing when channel 2 VARIABLE control (11) is not set to CAL position. Reminds user that channel 2 measurements are not calibrated.

13. MODE

Mode selector switch functions as follows:

CH1: Waveforms of CH1 are displayed.

CH2: Waveforms of CH2 are displayed.

DUAL: Waveforms of CH1 and CH2 are displayed for dual-trace observation.

ADD: The waveforms from CH1 and CH2 inputs are added and the sum is displayed as a single trace. When the CH2 POSITION control is pulled (PULL INVERT), the waveform from CH2 is subtracted from the CH1 waveform and the difference is displayed as a single trace.

X-Y: X-Y operation, CH1 input signal produces vertical deflection (Y axis). CH2 input signal produces horizontal deflection (X axis).

14. GND

GND terminal.

15. CAL 1kHz 0.1Vp-p

Provides 1 kHz, 0.1-volt peak-to-peak square wave signal. This is useful for probe compensation adjustment and a general check of oscilloscope calibration accuracy.

16. LED Pilot Lamp

This lamp lights when POWER (17) is ON.

17. POWER

Turning right will set the power ON. Power is turned off by turning left.

18. INTENSITY

Fully counterclockwise rotation of this control (OFF position) turns off oscilloscope. Clockwise rotation turns on oscilloscope. Further clockwise rotation of the control increases the brightness of the trace.

19. FOCUS

Spot focus control to obtain optimum waveform according to brightness.

20. ASTIG

Astigmatism adjustment provides optimum spot roundness and brightness when used in conjunction with FOCUS (19) and INTENSITY (18) control. Very little readjustment of this control is required after initial adjustment.

21. TRACE ROTATION

This is used to eliminate inclination of horizontal trace.

22. POSITION, PULL X5 MAG

Rotation adjusts horizontal position of trace (both traces in DUAL mode). Push-pull switch selects X5 magnification (PULL X5 MAG) when pulled out; normal when pushed in.

23. SWEEP TIME/DIV

Horizontal coarse sweep time selector. Selects calibrated sweep times of 0.1 μ s/div (microsecond per division) to 0.5 s/div in 21 steps when sweep time VARIABLE control is set to CAL position (fully clockwise).

Changeover between CHOP and ALT is accomplished automatically with this switch when SOURCE (33) is in any position other than ALT and NORM-CHOP is NORM.

24. VARIABLE

Fine sweep time adjustment. In the extreme clockwise (CAL) position the sweep time is calibrated.

25. UNCAL Lamp

Glows when sweep time VARIABLE control (24) is not set to CAL position.

Reminds user that time measurements are not calibrated.

26. NORM-CHOP

Pushbutton switch operates in conjunction with SOURCE switch (33) to provide automatic or manual selection of alternate or chop method of dual-trace sweep generation. Thus:

SOURCE switch in ALT position:

Alternate sweep is selected regardless of sweep time; NORM-CHOP switch has no effect.

SOURCE switch in any position except ALT and NORM-CHOP switch is in NORM (out position):

Alternate sweep is automatically selected at all sweep times of 0.5 ms/div and faster; chop sweep is automatically selected at all sweep times of 1 ms/div and slower.

NORM-CHOP switch is CHOP (in position):

Chop sweep is selected regardless of sweep time.

27. HOLDOFF

Rotation adjusts holdoff time (trigger inhibit period beyond sweep duration). Fully counterclockwise rotation is NORM, clockwise rotation increases holdoff period.

28. LEVEL, PULL SLOPE NEG

Sync level adjustment determines points on waveform slope where sweep starts; \ominus equals most negative point of triggering and \oplus equals most positive point of triggering. Push-pull switch selects positive or negative slope (PULL SLOPE NEG). Sweep is triggered on positive-going slope of sync waveform with switch pushed in; on negative-going slope of sync waveform when pulled out.

29. MODE

Four-position level switch selects triggering mode.

SINGLE: Enables RESET switch (30) for triggered single sweep operation.

NORM: Normal triggered sweep operation.

AUTO: Triggered sweep operation when trigger signal is present, automatically generates sweep (free runs) in absence of trigger signal.

FIX: Same as automatic mode, except trigger threshold is automatically fixed at center of trigger signal regardless of setting of LEVEL control (28).

30. RESET

When triggering MODE switch (29) is in SINGLE mode, pushing the RESET button initiates a single sweep which will begin when the next sync trigger occurs.

31. READY/TRIG'D

In SINGLE triggering mode (29), lights when RESET button (30) is pressed and goes off when sweep is completed. In NORM, AUTO and FIX triggering modes (29), lights for duration of triggered sweep; shows when LEVEL control (28) is properly set to obtain triggering.

32. COUPLING

Five-position level switch selects coupling for sync trigger signal.

AC: Trigger is AC-coupled.

LF Rej: Trigger signals below 10 kHz attenuated.

HF Rej: Trigger signals above 100 kHz attenuated.

VIDEO: Sync pulses of a composite video signal are used to trigger the sweep; the vertical sync pulses (frame) are automatically selected for sweep times of 0.5 s/div to 0.1 ms/div, and horizontal sync pulses (line) are automatically selected for sweep times of 50 μ s/div to 0.1 μ s/div.

DC: Trigger is DC-coupled.

33. SOURCE

Five-position lever switch selects sync trigger source.

INTERNAL Sync Positions:

ALTERNATE:

When MODE switch (13) is in CH1 or ADD modes, sweep is triggered by signal to channel 1 INPUT jack (2).

When MODE switch is in CH2 mode, sweep is triggered by signal to channel 2 INPUT jack (8).

When MODE switch is in DUAL-mode, channel 1 trace is triggered by channel 1 input signal and channel 2 trace is triggered by channel 2 input signal; scope operates in alternate sweep mode regardless of sweep time or setting of NORM-CHOP switch (26).

CH1: Sweep is triggered by signal to channel 1 INPUT jack regardless of MODE switch (13) selection.

CH2: Sweep is triggered by signal to channel 2 INPUT jack regardless of MODE switch (13) selection.

EXTERNAL Sync Positions

EXT 1: Sweep is triggered by signal at EXT TRIG jack (34). Trigger is unattenuated.

EXT1/10: Sweep is triggered by signal at EXT TRIG jack (34). Trigger is attenuated 10 : 1.

34. EXT TRIG

External sync terminal. For external triggering, external triggering voltage should be applied with SOURCE (33) set to EXT.

35. HANDLE

Use this handle to mount the oscilloscope in aslant position.

CONTROLS ON SIDE PANEL:

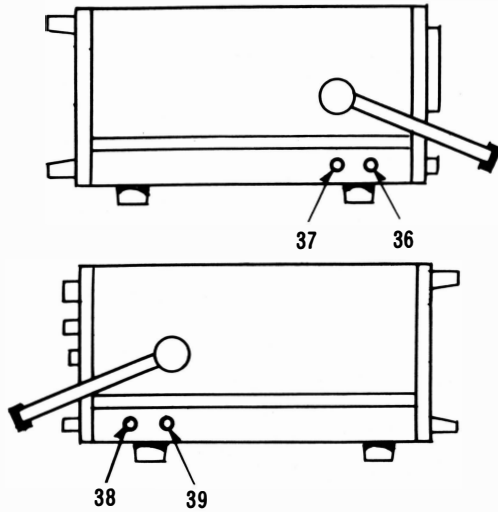

36. VARI. ATT. DC BAL.

For adjustment of CH1 (or Y) vertical DC balance. Adjustment should be made so that the waveform position is not shifted when VARIABLE (5) is turned.

37. STEP. ATT. DC BAL.

For adjustment of CH1 (or Y) vertical DC balance. Adjustment should be made so that the waveform position is not shifted when VOLTS/DIV (4) is turned.

38. VARI. ATT. DC BAL.

For adjustment of CH2 (or X) vertical DC balance. The function of this control is the same as that of VARI. ATT. BAL. (36).

39. STEP. ATT. DC BAL.

For adjustment of CH2 (or X) vertical DC balance. The function of this control is the same as that of STEP. ATT. BAL. (37).

CONTROLS ON REAR PANEL:

40. Fuse Holder

Fuse rated at 0.8A should be used for 100/117V operation. For operation on 220/240V, be sure to use a 0.5A fuse.

41. Z AXIS INPUT

Intensity modulation terminal. Intensity is modulated at TTL level.

42. Cord Reel

Wind power cord when the oscilloscope is to be carried or stored. They also serve as a stand when the oscilloscope is used in upright position.

43. Power Connector

AC power connector. For connection, use the supplied cord.

44. Power Voltage Selector

Set this switch to the correct operating voltage.

45. Voltage Plate

Use voltages and fuses specified.

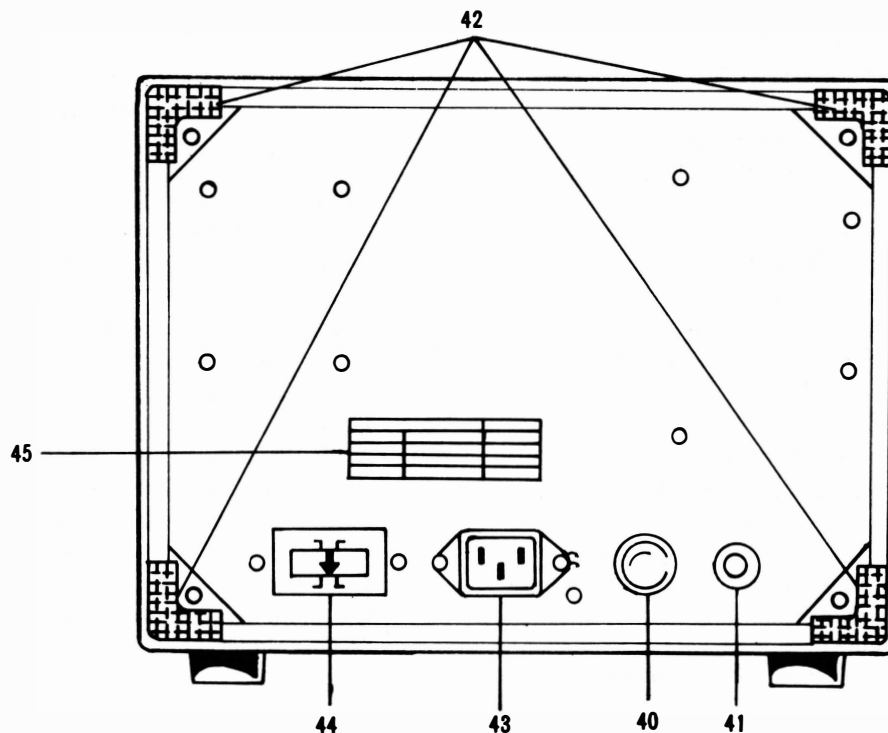

OPERATION

PRELIMINARY OPERATION

To ensure correct operation, set the oscilloscope as illustrated below before switching on the power. For detailed instructions, refer to "Controls on Panels".

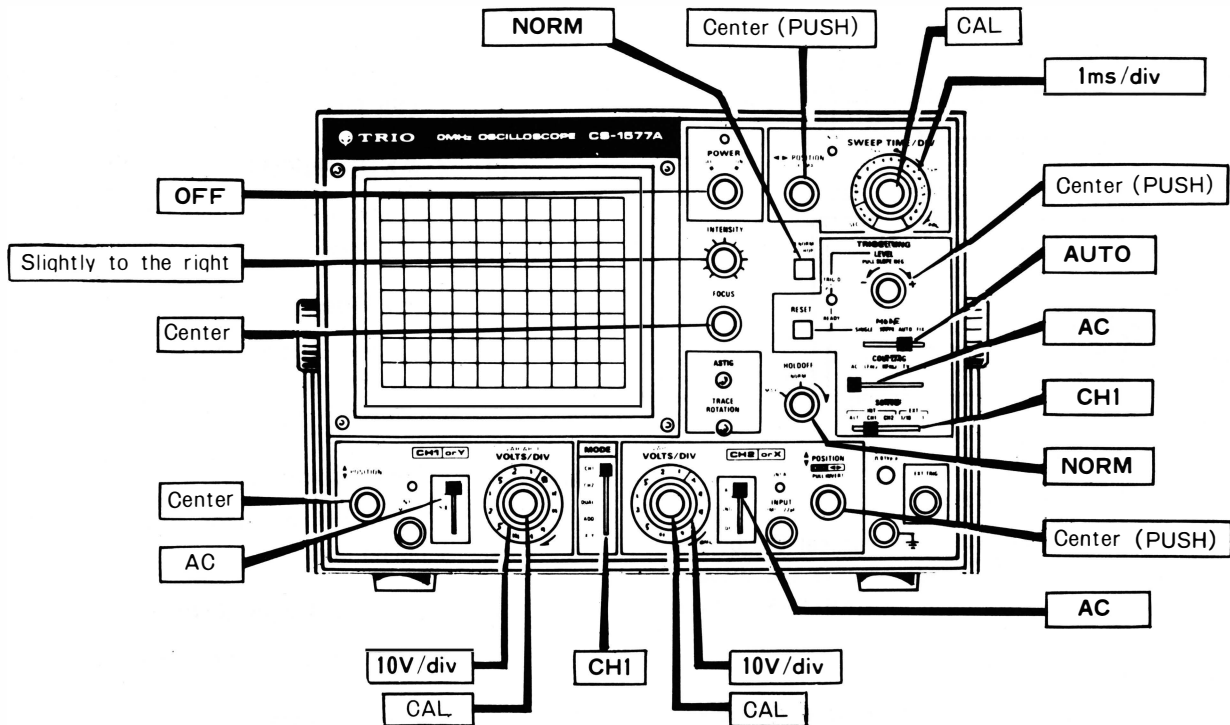

Operating Procedures (figures in [] denote CH2)

- (1) Set the power voltage selector to the correct voltage observing the arrow mark on the plug.
- (2) Turn POWER (17) clockwise. The power is turned to ON and LED pilot lamp (16) lights.
- (3) Horizontal axis will be displayed. When trace line does not appear at the center of the screen, adjust POSITION (1) [22]. Adjust brightness with INTENSITY (18). If the trace is unclear, adjust FOCUS (19).
- (4) The oscilloscope is now ready for measurement. For measurement, proceed as follows:
Apply a signal voltage to INPUT (2) [8]. Then turn VOLTS/DIV (4) [10] clockwise until the waveform is correctly displayed of the scope. By setting MODE (13) and SOURCE (33) to CH1, the CH1 input signal to INPUT (2) will appear. Similarly, by setting MODE and SOURCE to CH2, then the input signal to CH2 INPUT (8) will appear. At DUAL position, sweep times of 0.5s/div to 1ms/div are switched in CHOP mode and sweep times of 0.5ms/div to 0.1ms/div are switched in ALT mode. In either case, two waveforms are displayed on the screen.
At ADD position, algebraic sum of CH1 and CH2 (CH1+CH2) is obtained. When PULL INVERT (7)

- knob is pulled, the input to CH2 is applied to CH1 in reverse polarity and thus the algebraic difference (CH1-CH2) is obtained.
- (5) When the signal voltage is more than 2mV and waveform fails to appear on the screen, the oscilloscope may be checked by feeding input from CAL 1kHz 0.1Vp-p (15). Since calibration voltage is 0.1Vp-p, the waveform becomes 5 div at the 20mV/div position of VOLTS/DIV.
- (6) By setting MODE to NORM position, the free-running auto function is released. The waveform disappears when LEVEL (28) is turned clockwise or counterclockwise and appears again when it is returned to its approximate middle position of it. In both NORM and AUTO modes, triggering level can be adjusted.
- (7) When DC component is measured, set AC-GND-DC (3) [9] to DC. If, in this case, the DC component contains "+" potential, the waveform moves upward and if it contains "-" potential, the waveform moves downward.
The reference point of "0" potential can be checked at GND position.

TRIGGERING

To observe a stationary input signal waveform, the sweep circuit must be triggered correctly. This can be accomplished either by the input signal (INT) or by applying a signal, having a specific relationship (integer multiple) with input signal in terms of time, to the external trigger with input signal in terms of time, to the external trigger terminal (EXT).

Internal Triggering:

By setting TRIGGERING SOURCE (33) to INT (ALT CH1 or CH2), the input signal is connected to the internal trigger circuit. In this position, a part of the input signal fed to the input terminal (2 or 8) is applied from the vertical amplifier to the trigger circuit to cause the trigger signal synchronized with the input signal to drive the sweep circuit.

External Triggering:

External triggering is accomplished by setting the SOURCE switch (30) to EXT-1 or 1/10, provided a trigger signal is applied to the external trigger input terminal (34). External triggering is useful when you wish to trigger with a signal different from the input signal. It should be noted, however, that the trigger signal must have a relationship with the input signal in terms of time to ensure effective observation of waveform.

Fig. 1 shows that the sweep circuit is driven by the gate signal when the gate signal in the burst signal is applied to the input terminal.

Fig. 1 also shows the input/output signals, where the burst signal generated from the gate signal is applied to the instrument under test.

Thus, accurate triggering can be achieved without regard to the input signal fed to the terminals (2) and (18), so that no further triggering is required even when the input signal is varied.

Note that if the external trigger signal is too high, the triggering point cannot be adjusted satisfactorily by the TRIGGER LEVEL. If this occurs, the SOURCE switch should be set to EXT-1/10 so that the trigger signal is attenuated to 1/10. In this way, the triggering point can be adjusted.

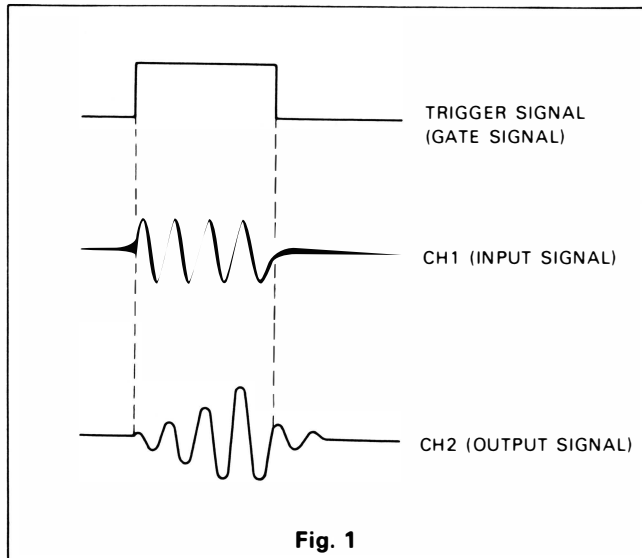

Fig. 1

Coupling:

The COUPLING switch (32) selects the coupling mode of the trigger signal to the trigger circuit according to the type of trigger signal (DC, AC, signal superposed on DC, signal with low frequency noise, signal with high frequency noise, etc.).

AC:

The AC (capacitance) coupling permits triggering by the AC component only; the DC component of the trigger signal is cut off. This range is normally used triggering is stabilized of the trigger signal is less than 10 Hz, the signal level becomes low which results in difficulty of triggering.

LF Rej:

The trigger signal is fed to the trigger circuit via a high pass filter where the low frequency component (less than 10 kHz) is eliminated and thus triggering is effected only by the high frequency component. As shown in Fig. 2, when the trigger signal contains low frequency noise (particularly hum), it is eliminated so that triggering is stabilized.

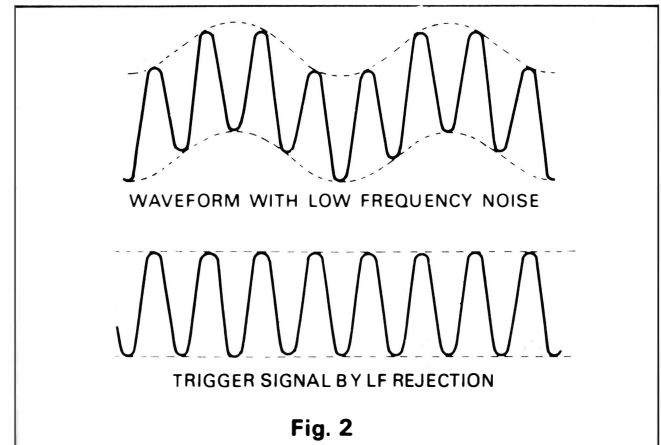

Fig. 2

HF Rej:

In contrast with LF REJ, the trigger signal is fed via a low pass filter where high frequency component (more than 100 kHz) is eliminated and thus triggering is effected only by the low frequency component. Fig. 3 shows that the high frequency noise contained in the waveform is eliminated so that triggering is stabilized.

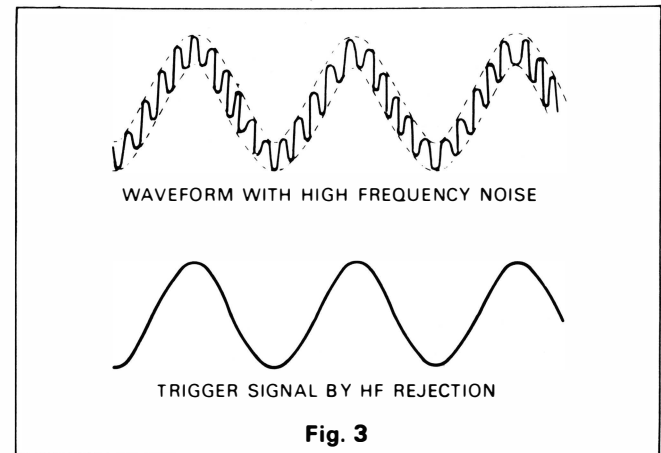

Fig. 3

VIDEO:

At the 0.5s/div-0.1ms/div position of SWEEP TIME/DIV, VIDEO-FRAME synchronization is effected for observation of the vertical frame, and at the 50 μ s/div-0.1 μ s/div position, VIDEO-LINE synchronization for observation of horizontal line. Set SLOPE (28) to a polarity that enables easy synchronization.

DC:

Trigger signal is directly coupled with the trigger circuit and triggering is effected by DC. This method is advantageous when triggering with a low frequency signal less than 10 Hz or a lamp waveform that varies with slow repeating DC.

Triggering Level:

Trigger point on waveform is adjusted by the SLOPE and LEVEL (28) controls. Fig. 4 shows the relationship between the SLOPE and LEVEL of trigger point. Triggering level can be adjusted as necessary.

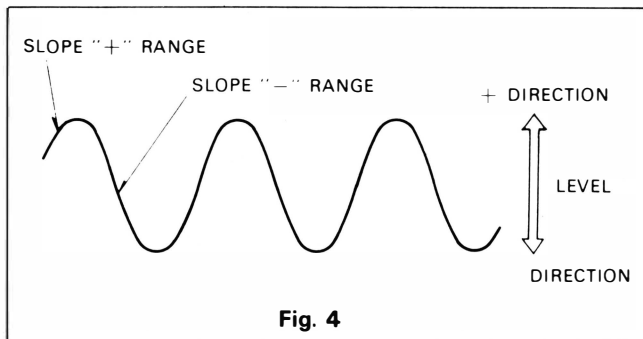

Auto Trigger:

By setting MODE (29) to AUTO or FIX, the sweep circuit becomes free-running as long as there is no trigger signal, permitting a check of GND level. When a trigger signal is present, the trigger point can be determined by the LEVEL and SLOPE for observation as in the normal trigger signal. When the triggering level exceeds the limit, the trigger circuit also becomes free-running where the waveform starts running. When Mode is in NORM position, there is no sweeping nor trace when trigger signal is absent or the triggering level exceeds the limit.

FIX:

When MODE is set to FIX, triggering is always effected in the center of waveform, eliminating the need for adjusting the triggering level. As shown in Fig. 5 (A) or (B), when MODE is set to NOR or AUTO and the triggering level is adjusted to either side of the signal, the trigger point is deviated as the input signal becomes small which, in turn, stops the sweep operation.

By setting MODE to FIX, the triggering level is automatically adjusted to the approximate center of the waveform and the signal is synchronized regardless of the position of LEVEL as shown in Fig. 5(C).

When the input signal is suddenly changed from a square waveform to a pulse waveform, the trigger point is shifted extremely toward the "-" side of the waveform unless the triggering level is readjusted as shown in Fig. 6 (A). See Fig. 6 (A)-(2), (3).

Also, if the trigger point has been set to the "-" of square waveform (Fig. 6(B)-(1)) and the input signal is changed to a pulse signal, the trigger point is deviated and the sweeping stops. When this happens, set MODE to AUTO position and the triggering is effected in the approximate center of the waveform, making it possible to observe a stabilized waveform. (Fig. 6(C)).

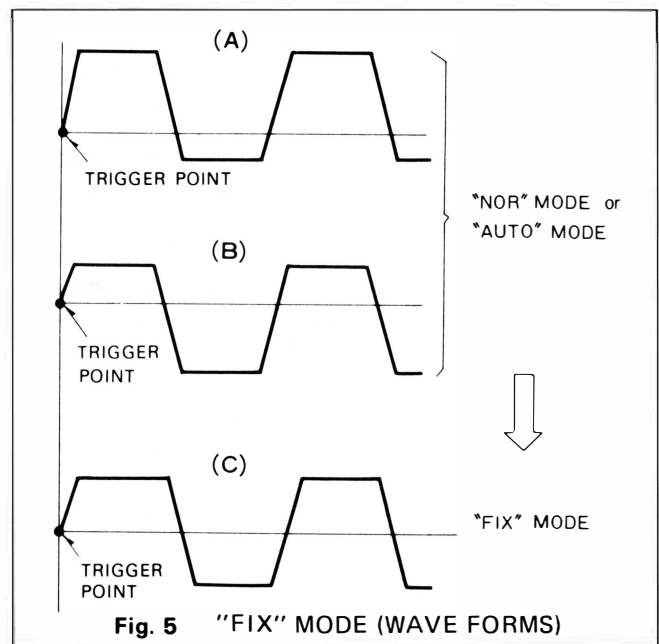

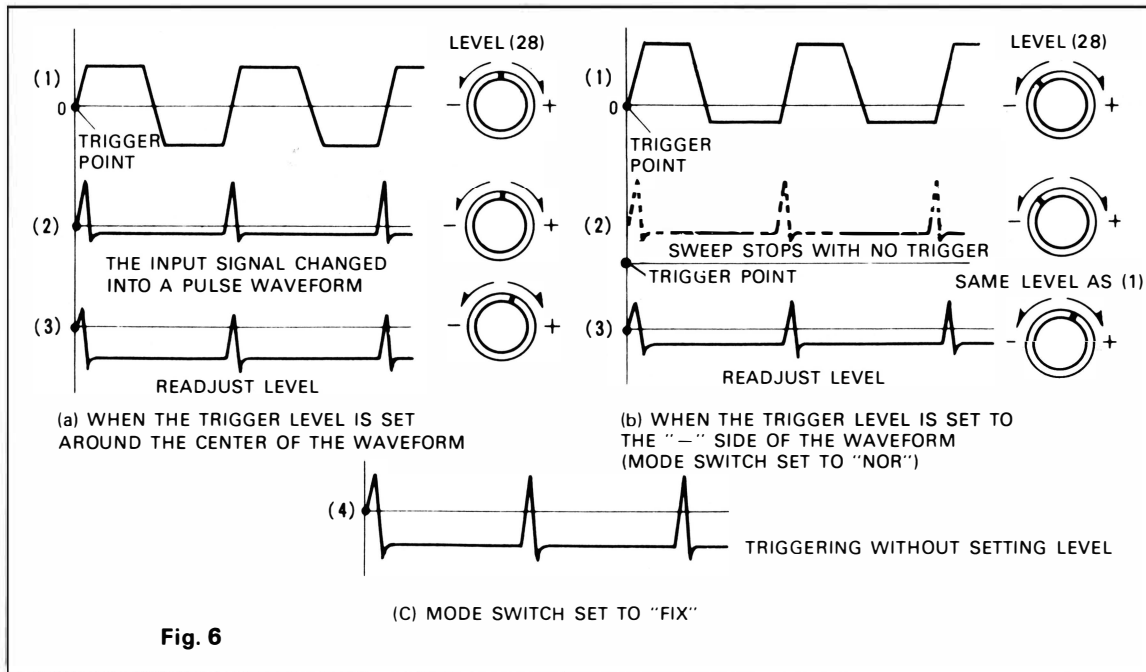

Triggering with HOLDOFF:

This control is usually set to the NORM position (fully counterclockwise) because no hold off period is necessary. The HOLDOFF controls are useful when a complex series of pulses appear periodically, such as in Fig. 7. Improper sync may produce a double image as in Fig. 8. Such a display could be synchronized with the sweep time VARIABLE control (24), but this is impractical because time measurements are then uncalibrated. An alternate method of synchronizing the display is with the HOLDOFF control, which adjusts the duration of a period after the sweep in which triggering is inhibited. The sweep speed remains the same, but the triggering of the next sweep is "held off" by the duration selected by the HOLDOFF control. Turn the HOLDOFF control clockwise from the NORM position until the sweep starts at the same point of the waveform each time. At the MAX setting, the hold off period is about 10 times greater than at the lowest setting.

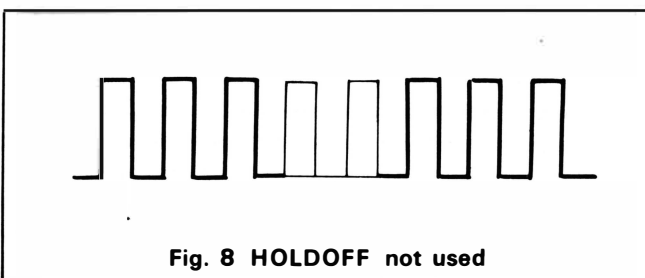
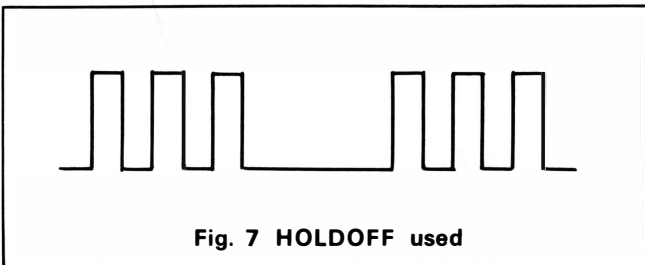

Single Sweep Operation:

SINGLE position. This position enables the single sweep mode and is used in conjunction with RESET button (30) and READY light (31). When the single sweep mode is selected and the RESET button has been pushed, the next sync trigger will start a single sweep. The RESET button must be pushed again to enable another single sweep. The READY light goes on when the RESET button is pushed, indicating that the scope is ready to be triggered. The light goes off when the sweep is completed. Single sweep operation is valuable for viewing irregular waveforms, or instantaneous waveforms such as chattering when mechanical switches are operated. Such waveforms cannot be observed clearly when normal repeating sweep is used. This method is also advantageous when photographing such waveforms.

APPLICATIONS

DUAL-TRACE APPLICATIONS

Introduction:

The most obvious and yet the most useful feature of the dual-trace oscilloscope is that it has the capability for simultaneously viewing two waveforms that are frequency or phase-related, or that have a common synchronizing voltage, such as in digital circuitry. Simultaneously viewing of input and its output is an invaluable aid to the circuit designer or the repairman. Several possible applications of the dual-trace oscilloscope will be reviewed in detail to familiarize the user further in the basic operation of this oscilloscope.

When observing two signals having different frequencies simultaneously, the signal having the low frequency should be the triggered.

Frequency Divider Waveforms

Fig. 9 illustrates the waveform involved in a basic

divide-by-two circuit. Fig. A indicates the reference or clock pulse train. Fig. B and Fig. C indicates the possible outputs of the divide-by-two circuitry. Fig. 9 also indicates the settings of specific oscilloscope controls for viewing these waveforms. In addition to these basic control settings, the TRIGGERING LEVEL control, as well as the CH1 and CH2 vertical position controls should be set as required to produce suitable displays. In the drawing of Fig. 9, the waveform levels of 2 cm are indicated. The CH2 waveform may be either that indicated in Fig. 9B or Fig. 9C. In Fig. 9C, the divide-by-two output waveform is shown for the case where the output circuitry responds to a negative-going waveform. In this case, the output waveform is shifted with respect to the leading edge of the reference frequency pulse by a time interval corresponding to the pulse width.

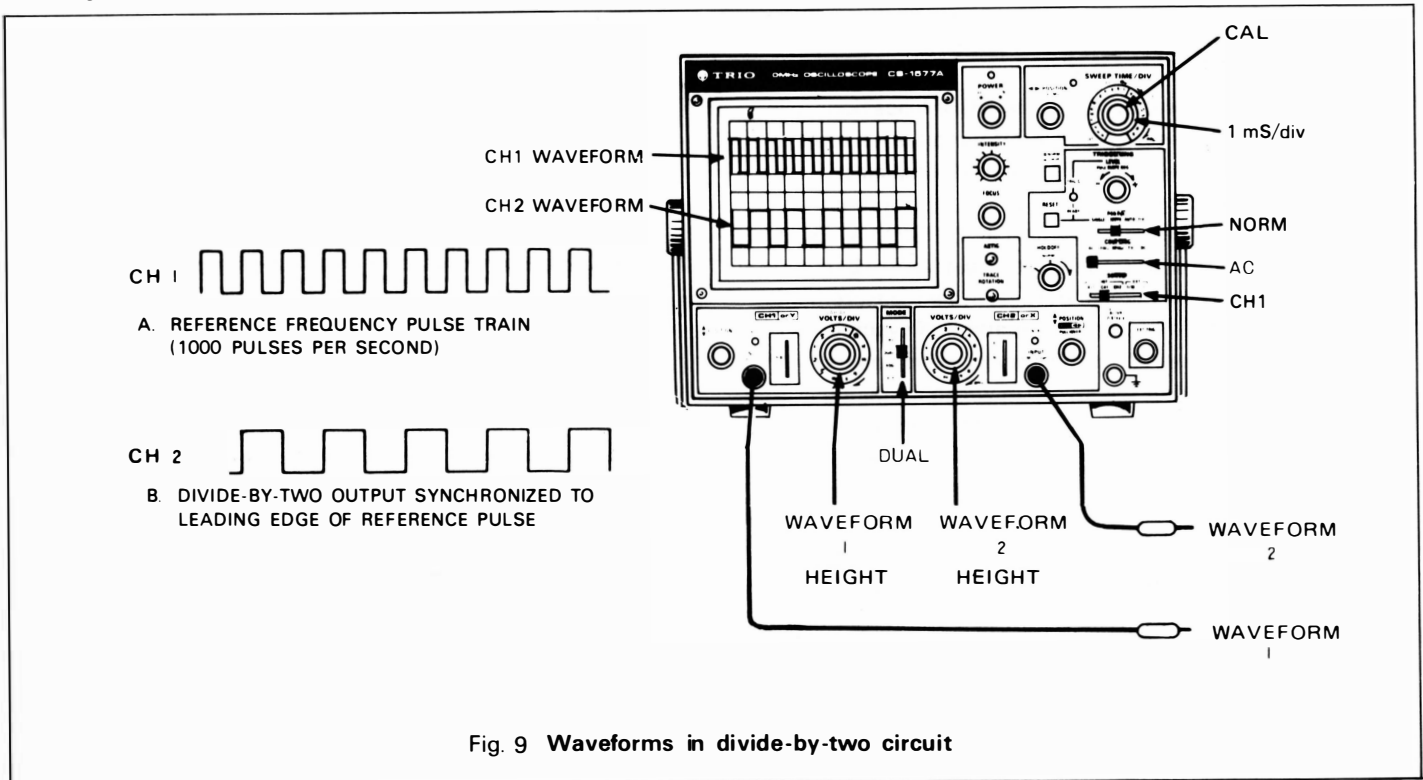

Fig. 9 Waveforms in divide-by-two circuit

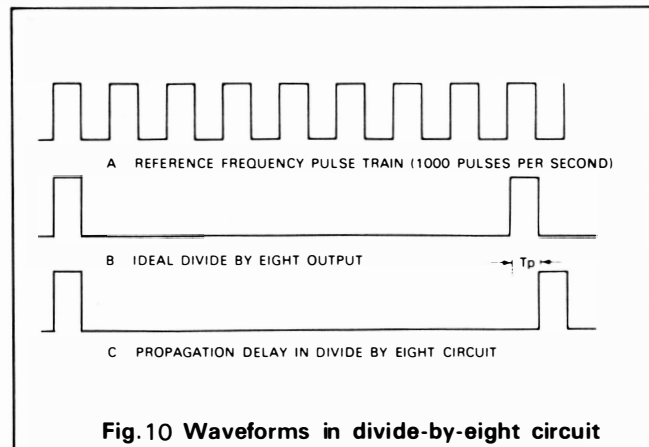

Fig.10 Waveforms in divide-by-eight circuit

Divide-by-8 Circuit Waveforms:

Fig. 10 indicates waveform relationships for a basic divide-by-eight circuit. The basic oscilloscope settings are identical to those used in Fig. 8. The reference frequency of Fig. 10A is supplied to the CH1 input, and the divide-by-eight output is applied to the CH2 input. Fig. 10 indicates the time relationship between the input pulses and output pulses.

In an application where the logic circuitry is operating at or near its maximum design frequency, the accumulated rise time effects of the consecutive stages produce a built-in time propagation delay which can be significant in a critical circuit must be compensated for Fig. 10C indicates the possible time delay which may be introduced into a

frequency divider circuit. By use of the dual-trace oscilloscope, the input and output waveforms can be superimposed (ADD or SUB) to determine the exact amount of propagation delay that occurs.

Significant propagation delay may occur in any circuit with several consecutive stages. Using the procedures given for calibrated time measurement, T_p can be calculated.

A more precise measurement can be obtained if the T_p portion of the waveform is expanded horizontally. This may be done by pulling the PULL $\times 5$ MAG control. It also may be possible to view the desired portion of the waveform at faster sweep speed.

Propagation Delay Time Measurement:

An example of propagation delay in a divide-by-eight circuit was given in the previous paragraph. Significant propagation delay may occur in any circuit with several consecutive stages. This oscilloscope has features which simplify measurement of propagation delay. Fig. 11 shows the resultant waveforms when the dual-trace presentation is combined into a single-trace presentation by selecting the ADD position of the MODE switch. With CH2 PULL INVERT switch in the normal position (pushed in) the two inputs are algebraically added in a single-trace display. Similarly, in the inverted position (pulled) the two inputs are algebraically subtracted. Either position provides a precise display of the propagation time (T_p). Using procedure given for calibrated time measurement, T_p can be measured. A more precise measurement can be obtained if the T_p portion of the waveform is expanded horizontally. This may be done by pulling the PULL $\times 5$ MAG control. It also may be possible to view the desired portion of the waveform at a faster sweep speed.

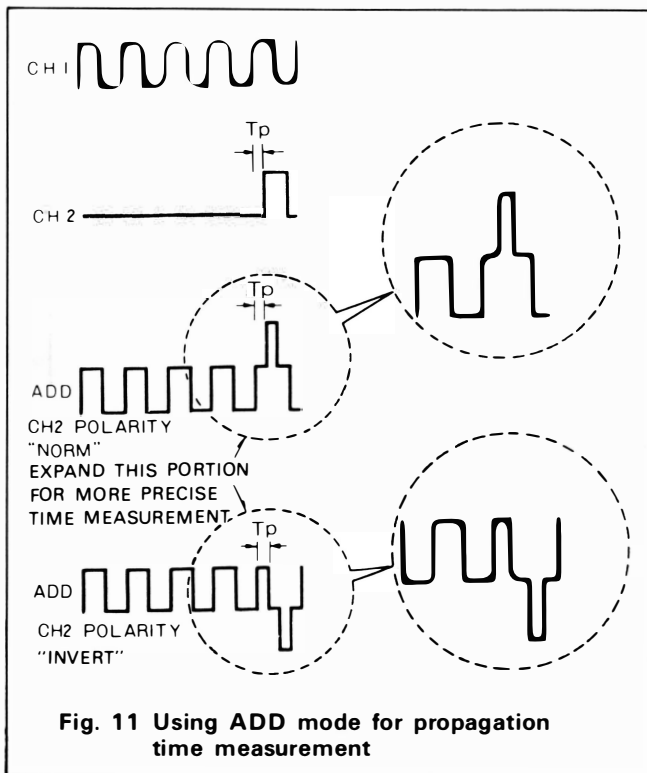

Fig. 11 Using ADD mode for propagation time measurement

Measurement of High-speed Pulse Signal Rising Characteristic:

The measurement of the rising time of pulse signal is one of the important factors when analyzing a waveform. Normally, the rising waveform of a high-speed pulse must be fully displayed on the screen of the CRT by delaying the vertical signal via the delay circuit.

By using the delay cable, the signal on the screen is delayed more than 10 ns so that the rising waveform can be fully observed, where the sweep time is 20 ns/DIV at maximum sweep. In this case, the signal on the screen is delayed about 0.5 DIV and thus the waveform before the trigger point can be observed as shown in Fig. 12. In other words, the trigger point of vertical signal appears on the screen about 10 ns after the sweep signal is started. In this way, the rising time of a high-speed pulse signal can be easily observed.

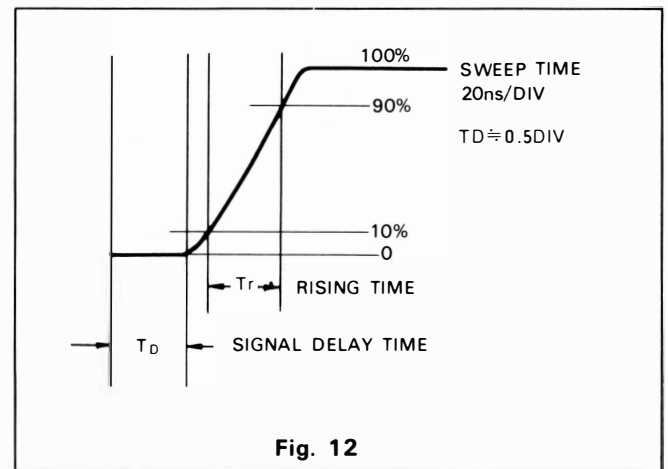

Fig. 12

Digital Circuit Time Delay Measurement:

A dual-trace oscilloscope is a necessity in designing, manufacturing and servicing digital equipment. A dual-trace oscilloscope permits easy comparison of time relationships between two waveforms. In digital equipment, it is common for a large number of circuits to be synchronized, or to have a specific time relationship to each other. Many of the circuits are frequency dividers as previously described, but waveforms are often time-related in many other combinations. In the dynamic state, some of the waveforms change, depending upon the input or more mode of operation. Fig. 13 shows a typical digital circuit and identifies several of the points at which waveform measurements are appropriate. The accompanying Fig. 13 shows the normal waveforms to be expected at each of these points and their timing relationships. The individual waveforms have limited value unless their timing relationship to one or more of the other waveforms is known to be correct. The dual-trace oscilloscope allows this comparison to be made. In typical fashion, waveform No. 3 would be displayed on CH1 and waveform No. 4 through No. 8 and No. 10, would be displayed on CH2 although other timing comparisons may be desired. Waveform No. 11 through No. 13 would probably be displayed on CH2 in relationship to waveform No. 8 or No. 4 on CH1. In the family of time-related

waveforms shown in Fig. 14, waveform No. 8 or No. 10 is excellent sync source for viewing all of the waveforms; there is but one triggering pulse per frame. For convenience, external sync using waveform No. 8 or No. 10 as the sync source may be desirable. With external sync, any of the waveforms may be displayed without readjustment of the sync controls.

With No. 8 or No. 10 used as external triggering source, any of the waveforms may be displayed without

readjustment of the TRIG LEVEL control. Waveforms No. 4 through No. 7 should not be used as the triggering source because they do not contain a triggering pulse at the start of the frame. It would not be necessary to view the entire waveforms as shown in Fig. 14 in all cases. In fact, there are many times when a closer examination of a portion of the waveforms would be appropriate. In such cases, it is recommended that the sweep speed be increased or X5 MAG control used to expand the waveform display.

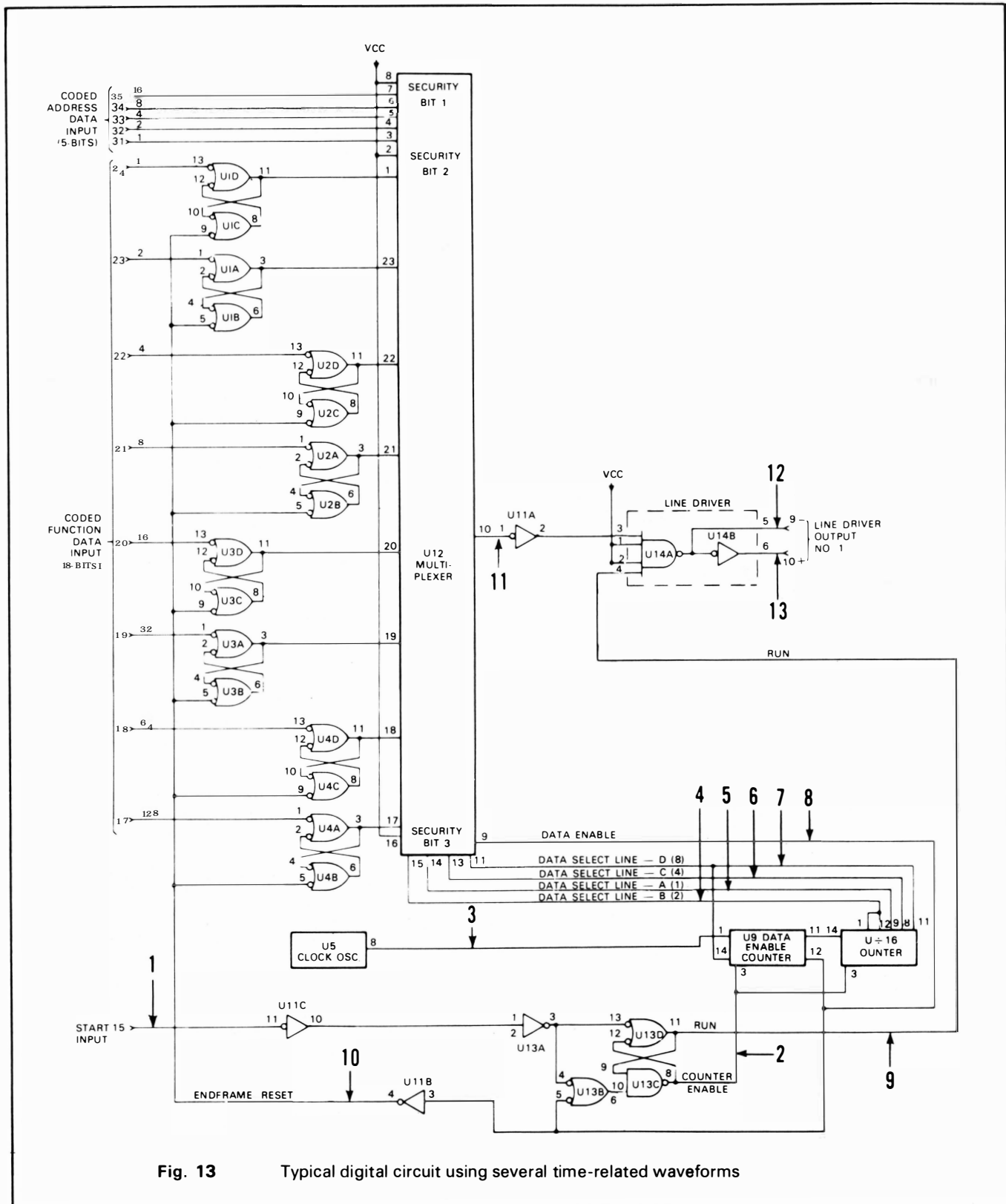

Fig. 13 Typical digital circuit using several time-related waveforms

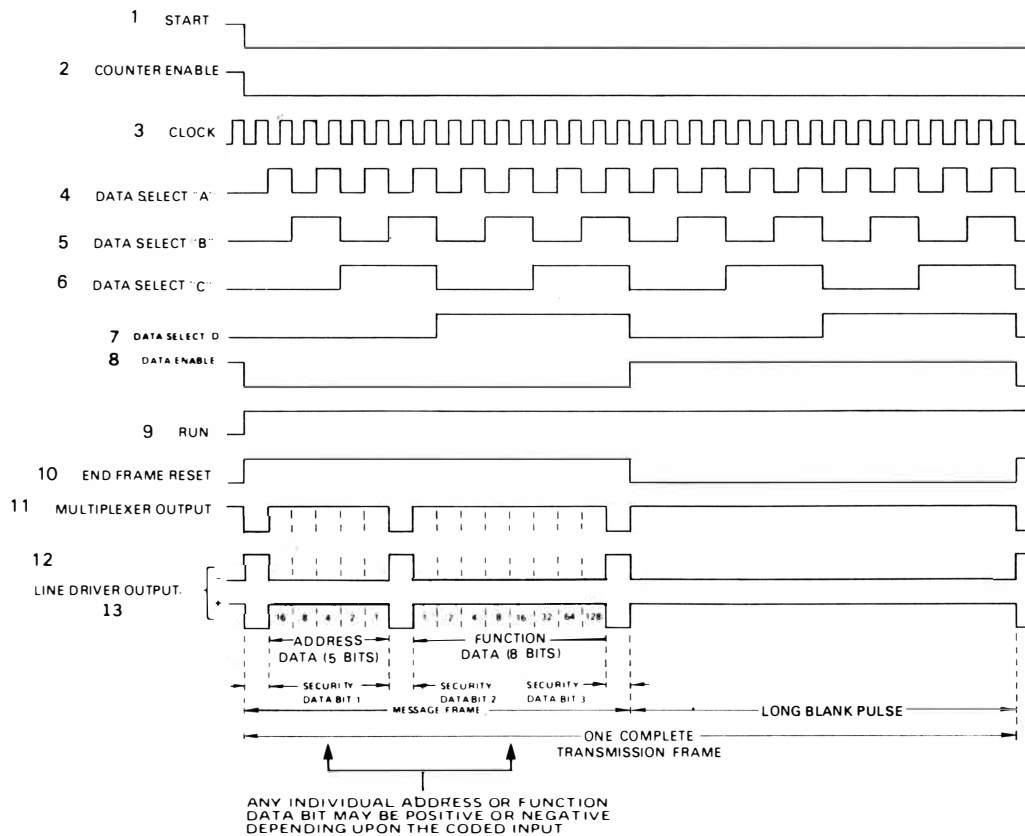

Fig. 14 Family of time-related waveforms from typical digital circuit in Fig. 12

Distortion Measurement:

An amplifier stage or an entire amplifier unit may be measured for distortion with this oscilloscope. This type of measurement is especially variable when the slope of a waveform must be faithfully reproduced by an amplifier. Fig. 15 shows the testing of such a circuit using a triangular wave, such as is typically encountered in the recovered audio output of limiting circuit which precedes the modulator of transmitter. The measurement may be made using any type of signal; merely use the type of signal for testing that is normally applied to the amplifier during normal operation. The procedure for distortion testing follows:

1. Apply the type of signal normally encountered in the amplifier under test.
2. Connect CH1 probe to the input of the amplifier and CH2 probe to the output of the amplifier. It is preferable if the two signals are not inverted in relationships to each other, but inverted signals can be used.
3. Set CH1 and CH2 AC-GND-DC switches to AC.
4. Set MODE switch to DUAL, and NORM-CHOP button to NORM.

5. Set sync SOURCE switch to CH1 and adjust controls as described in waveform viewing procedure for synchronized waveforms.
6. Adjust CH1 and CH2 POSITION controls to superimpose the waveforms directly over each other.
7. Adjust CH1 and CH2 vertical sensitivity controls (VOLTS/DIV and VARIABLE) so that the waveforms are as large as possible without exceeding the limits of the scale, and so that both waveforms are exactly the same height.
8. Now, set the MODE switch to ADD position and pull CH2 POLARITY switch (if one waveform is inverted in relationships to the other, use normal CH2 polarity). Adjust the fine vertical sensitivity control (CH2 VARIABLE) slightly for the minimum remaining waveform. Any waveform that remains equals distortions; if the two waveforms are exactly the same amplitude and there is no distortion, the waveforms will cancel and there will be only a straight horizontal line remaining on the screen.

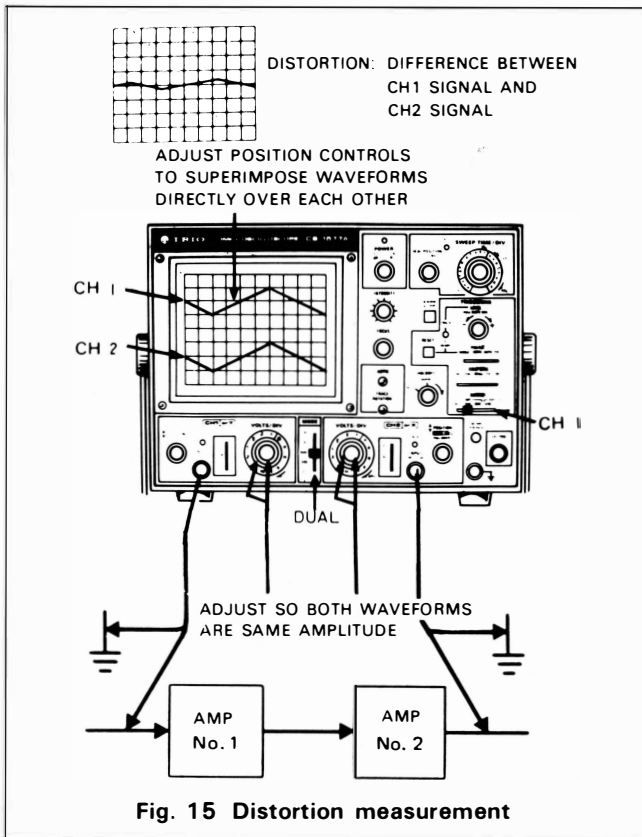

Fig. 15 Distortion measurement

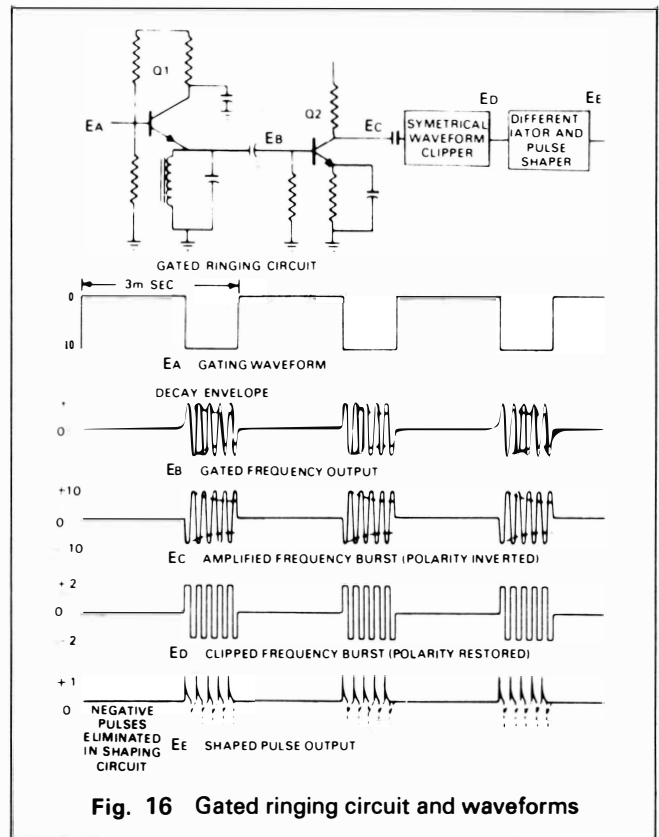

Fig. 16 Gated ringing circuit and waveforms

Gated Ringing Circuit (burst circuit):

The circuit and waveform of Fig. 16 are shown to demonstrate the type of circuit in which the dual-trace oscilloscope is effective both in design and troubleshooting applications.

Fig. 16 shows a burst circuit. The basic settings are identical to those of in Fig. 9. Waveform EA is the reference waveform and is applied to CH1 input. All other waveforms are sampled at CH2 and compared to the reference waveform of CH1. The frequency burst signal can be examined more closely either by increasing the sweep time per division to 0.5 ms per division or by pulling out on the POSITION control to obtain 5 times magnification. This control can then be rotated as desired to center the desired waveform information on the oscilloscope screen.

Delay Line Test:

The dual-trace feature of the oscilloscope can also be used to determine the delay times of transmission type delay lines as well as ultrasonic type delay lines. The input pulse can be used to trigger or synchronize the CH1 display and the delay line output can be observed on CH2. A respective type pulse will make it possible to synchronize the displays. The interval between repetitive pulses should be large compared to the delay time to be investigated. In addition, to determining delay time, the pulse distortion inherent in the delay line can be determined by examination of the delay pulse observed on CH2 waveform display.

Fig. 17 shows the typical oscilloscope settings as well as the basic test circuit. Typical input and output waveforms are shown on the oscilloscope display. Any pulse stretching and ripple can be observed and evaluated. The results of modifying the input and output terminations can be

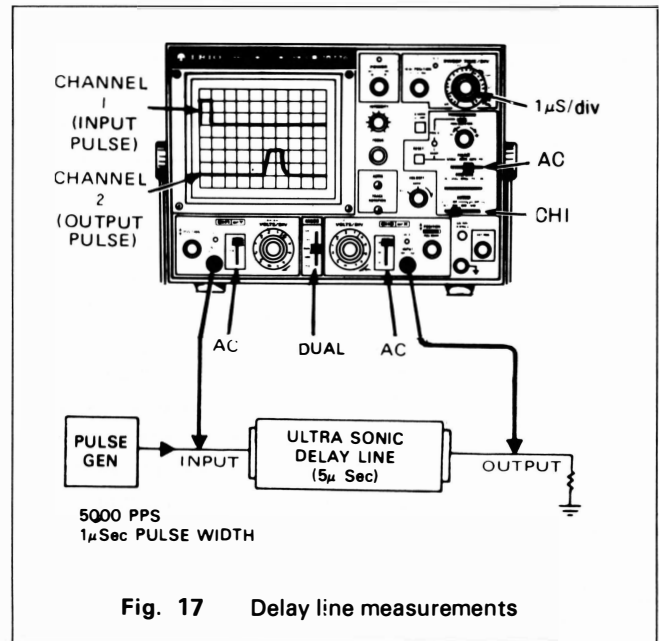
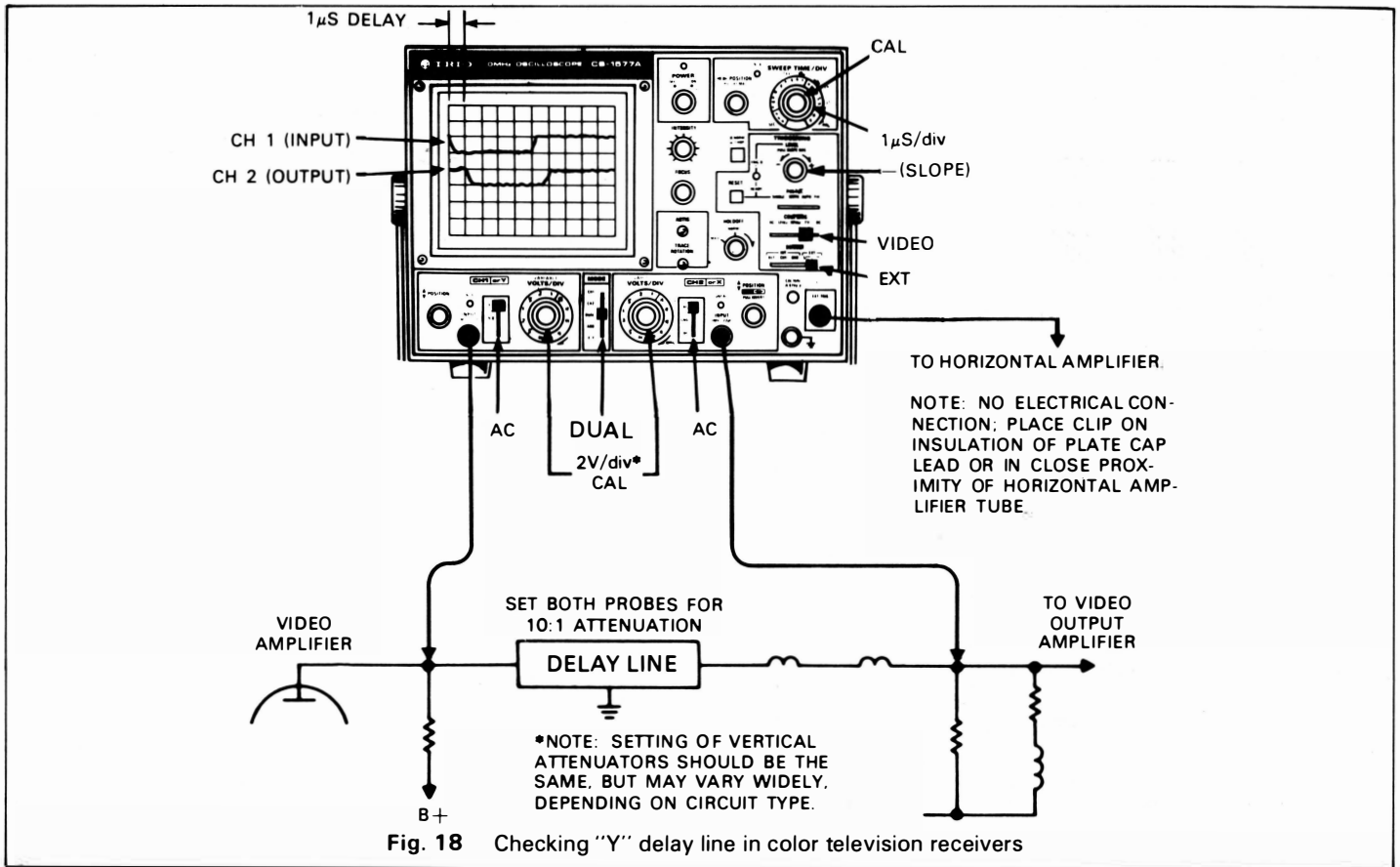

Fig. 17 Delay line measurements

observed directly.

A common application of the delay line checks is found in color television receivers to check the "Y" delay line employed in the video amplifier section. The input waveform and the output waveform are compared for delay time, using the horizontal sync pulse of the composite video signal for reference. The delay is approximately one microsecond. In addition to determining the delay characteristics of the line, the output waveform reveals any distortion that may be introduced from an impedance mismatch or greatly attenuated output resulting from an open line.



Stereo Amplifier Servicing:

Another convenient use for a dual-trace oscilloscope is in troubleshooting stereo amplifiers. If identical amplifiers are used and the output of one is weak, distorted or otherwise abnormal, the dual-trace oscilloscope can be efficiently used to localize the defective state. With an identical signal applied to the inputs of both amplifiers, a side-by-side comparison of both units can be made by progressively sampling identical signal points in both amplifiers. When the defective or malfunctioning stage has been located, the effects of whatever troubleshooting and repair methods are employed can be observed and analyzed immediately.

Improving the Ratio of Desired to Undesired Signals:

In some application, the desired signal may be riding on a large undesired signal component such as 50 Hz. It is possible to minimize or for practical purpose eliminate the undesired component. Fig. 19 shows the oscilloscope controls setting for such an application. The waveform display of CH1 indicates the desired signal and the dotted line indicates the average amplitude variation corresponding to the undesired 50 Hz component. The CH2 display indicates a waveform of equal amplitude and identical phase to the average of the CH1 waveform. With the MODE switch set to ADD and CH2 signal inverted, and the CH2 signal inverted, and by adjusting the CH2 vertical attenuator control, the 50 Hz component of the CH1 signal can be cancelled by the CH2 input and the desired waveform can be observed.

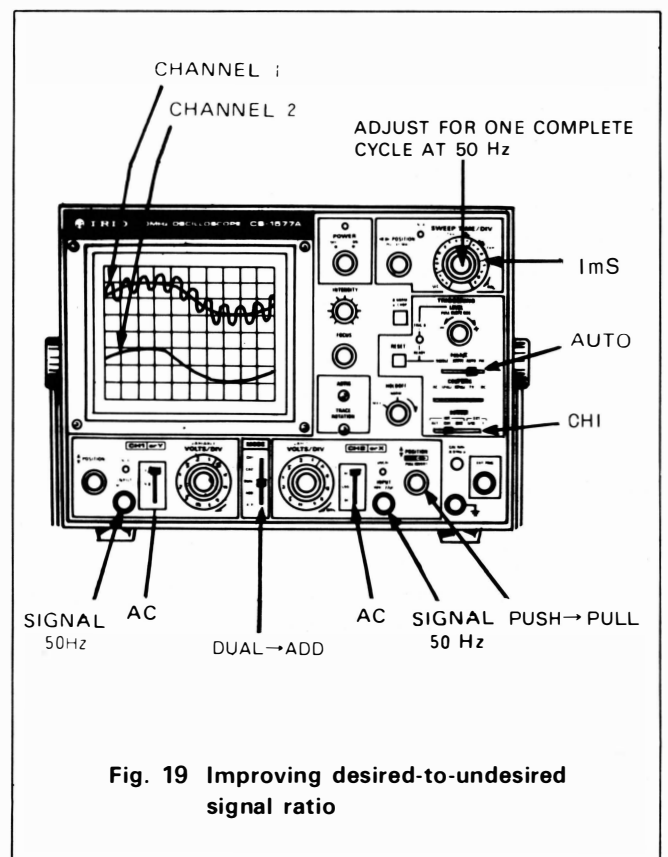

Amplifier Phase Shift Measurements:

Phase measurements can be made by several methods using oscilloscopes. Typical applications are in circuits designed to produce a specific phase shift, and measurement of phase shift distortion in audio amplifiers and networks.

In all amplifiers, a phase shift is always associated with a change in amplitude response. For example, at the -3 dB response points, a phase shift of 45° occurs. Phase measurements can be performed by operating the oscilloscope either in the dual-trace mode or the X-Y mode. This method uses the dual-trace mode to measure amplifier phase shift directly. Fig. 20 illustrates this method. In this case, the measurements are being made at approximately 5000 Hz. The input signal to the audio amplifier is used as a reference and is applied to the CH1 input jack.

The VARIABLE control is adjusted as required to

provide a complete cycle of the input waveform displayed on 8 div horizontally. A waveform height of 2 div is used. The 8 div display represents 360° at the displayed frequency and each centimeter represents 45° of the waveform.

The signal developed across the output of the audio amplifier is applied to the CH2 input jack.

The vertical attenuator controls of CH2 are adjusted as required to produce a peak-to-peak waveform of 2 div as shown in Fig. 20B. The CH2 POSITION control is then adjusted so that the CH2 waveform is displayed on the same horizontal axis as the CH1 waveform as shown in Fig. 20B. The distance between corresponding points on the horizontal axis for the two waveforms then represents the phase shift between the two waveforms. In this case the zero crossover points of two waveforms are compared. It is shown that a difference of 1 div exists. This is then interpreted as means a phase shift of 45° .

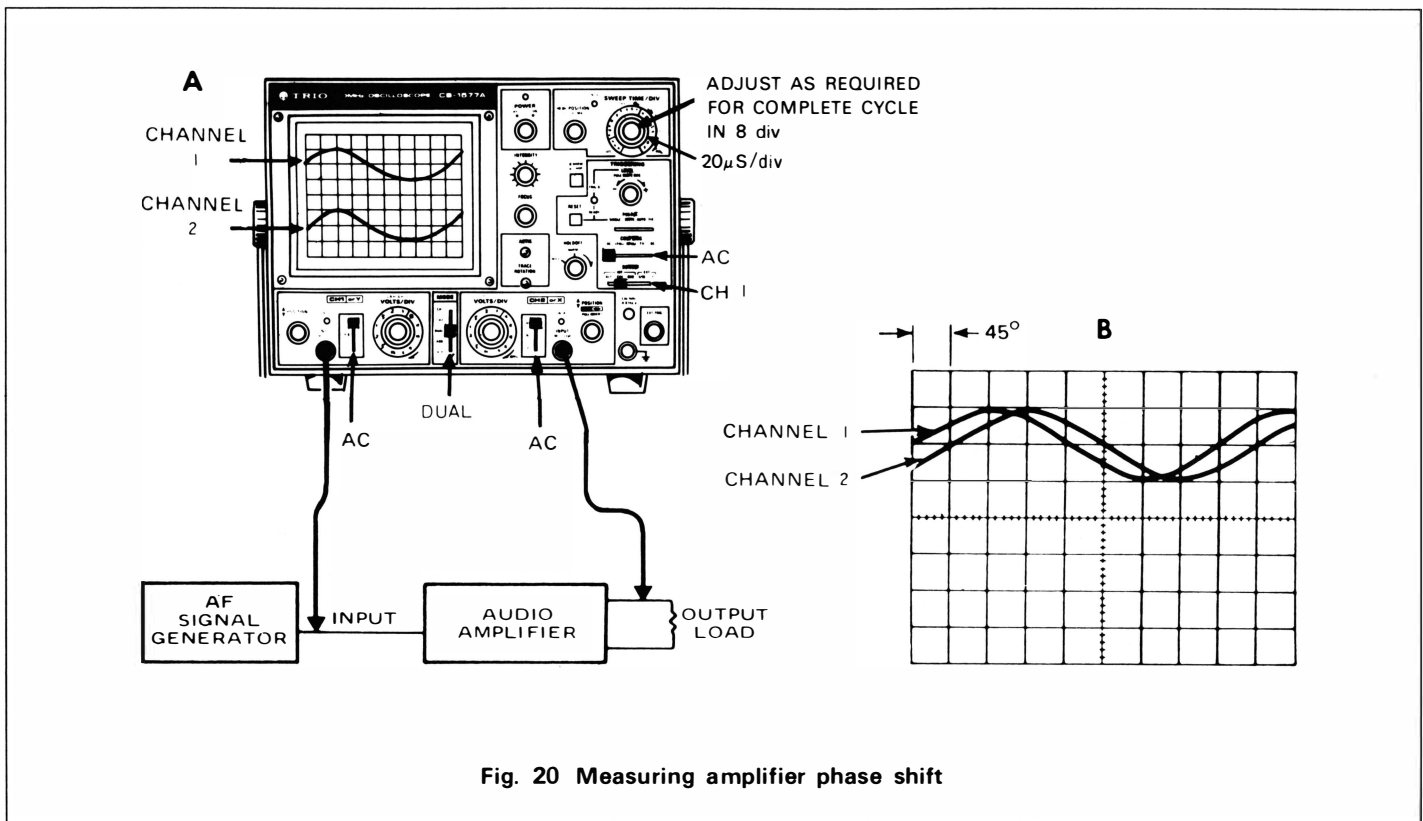

Fig. 20 Measuring amplifier phase shift

Television Servicing:

Many of the television servicing procedures can be performed using single-trace operation. These are outlined later in the applications section covering single-trace operation. One of these procedures, viewing the VITS (vertical interval test signal), can be accomplished much more effectively using a dual-trace oscilloscope. As outlined in the single-trace applications section and as shown in Fig. 24, the information on the Field 1 and Field 2 vertical blanking interval pulse is different. This is shown in detail in Fig. 24. Also, because the oscilloscope sweep is synchronized to the vertical blanking interval waveform, the Field 1 and Field 2 waveforms are superimposed onto each other. With dual-trace operation, the signal information on each blanking pulse can be viewed separately without over-

lapping. Fig. 23 indicates the oscilloscope control setting for viewing the alternate VITS.

Most network television signals contain a built-in test signal (the VITS) that can be a very valuable tool in troubleshooting and servicing television sets. This VITS can localize trouble to the antenna, tuner, IF or video sections and shows when realignment may be required. The following procedures show how to analyze and interpret oscilloscope displays of the VITS.

The VITS is transmitted during the vertical blanking interval. On the television set, it can be seen as a bright white line above the top of the picture, when the vertical linearity or height is adjusted to view the vertical blanking interval (on TV sets with internal retrace blanking circuits, the blanking circuit must be disabled to see the VITS).

The transmitted VITS is precision sequence of a specific frequencies, amplitudes and waveshapes as shown in Fig. 21. The television networks use precision signals for adjustment and checking of network transmission equipment, but technician can use them to evaluate television performance. The first frame of VITS at the "B"

section (line 18) in Fig. 21 begins with a white reference signal, followed by sine wave frequencies of 0.5 MHz, 1.0 MHz, 2 MHz, 3 MHz, 4.0 MHz and 3.58 MHz. This sequence of frequencies is called the "multi-burst".

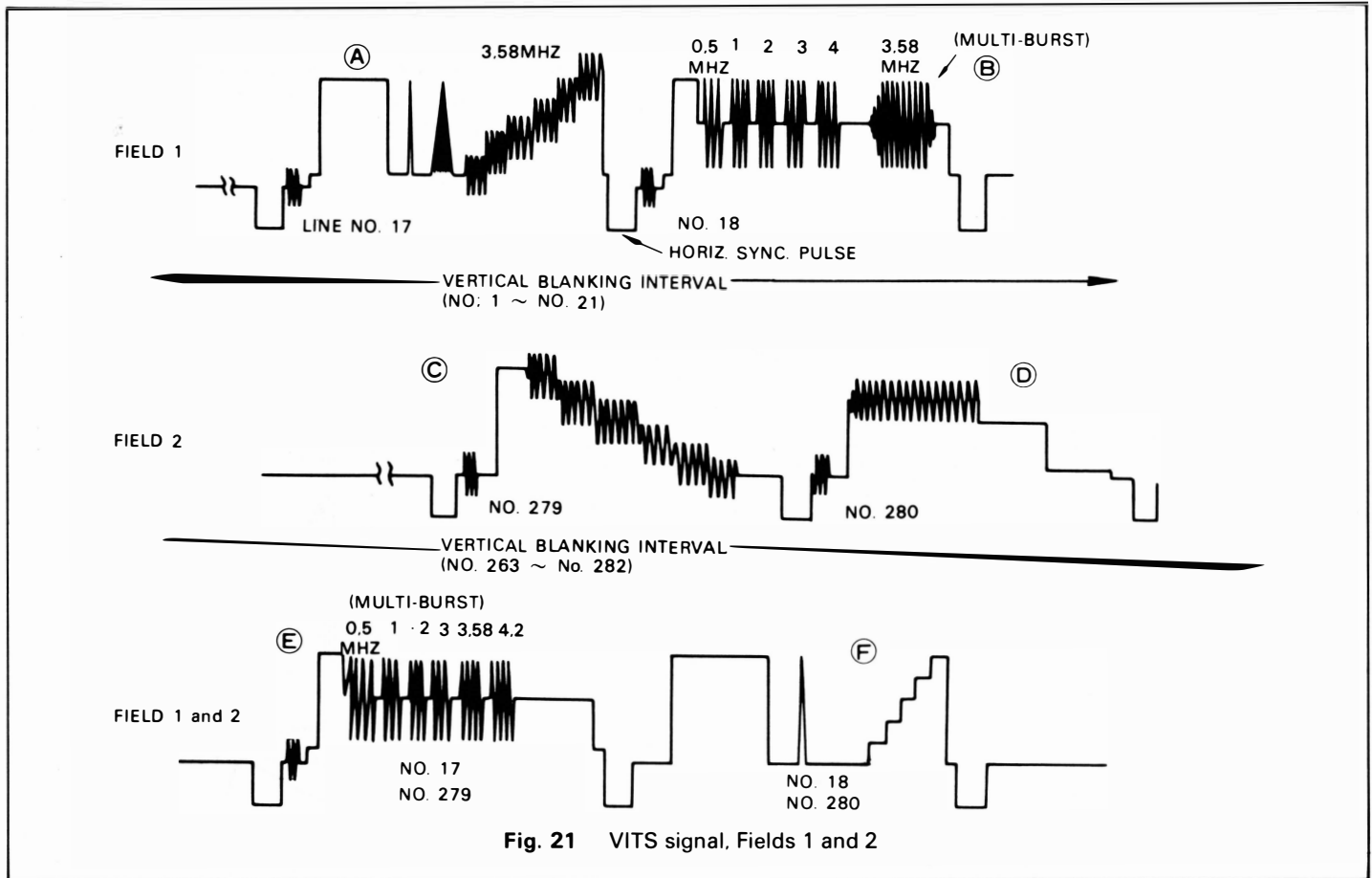

Fig. 21 VITS signal, Fields 1 and 2

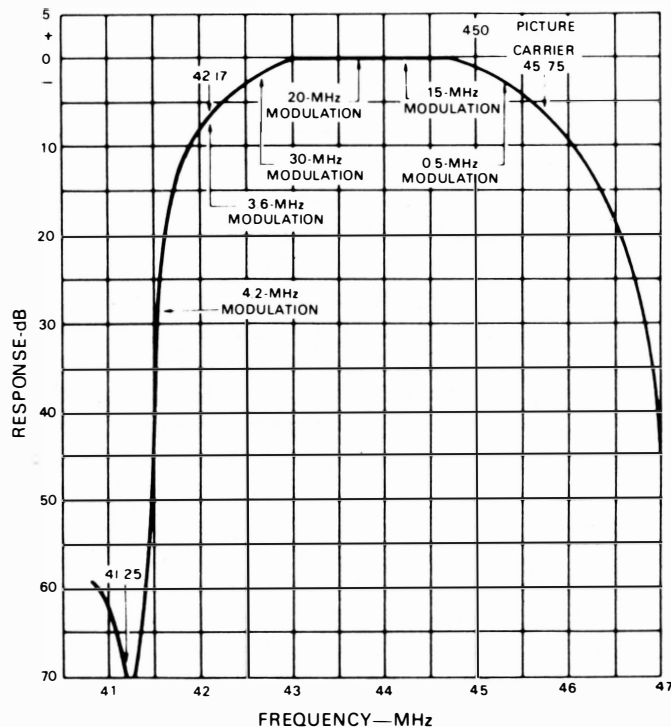

Fig. 22 Color TV IF amplifier response curve

This multi-burst portion of the VITS is the portion that can be most valuable to the technician. The second line of Field 1 and the second line of Field 2 (lines 18 and 280) may contain the sine-squared pulse, window pulse and the staircase of 3.58 MHz bursts at progressively lighter shading. These are valuable to the network, but have less value to the technician. As seen on the television screen, Field 1 is interlaced with Field 2 so that line 17 is followed by line 279 and line 18 is followed by line 280. The entire VITS appears at the bottom of the vertical blanking pulse and just before the first line of video.

Now to analyze the waveform. All frequencies of the multi-burst are transmitted at the same level, but should not be equally coupled through the receiver due to its response curve. Fig. 22 shows the desired response for a good color television receiver, identifying each frequency of the multi-burst and showing the allowable amount of attenuation for each. Remember that -6 dB equals half the reference voltage (the 2.0 MHz modulation should be used for reference).

To localize trouble, start by observing the VITS at the video detector. This will localize trouble to a point either before or after the detector. If the multi-burst is normal at the detector, check the VITS on other channels. If some

channels look okay but others do not, you probably have tuner or antenna-system troubles. Don't overlook the chance of the antenna system causing "holes" or tilted response on some channels. If the VITS is abnormal at the video detector on all channels, the trouble is probably in the IF amplifier stages.

As another example, let us assume that we have a set on the bench with a very poor picture. Our oscilloscope shows the VITS at the video detector to be about normal except that the burst at 2.0 MHz is low compared to the bursts on either side. This suggests an IF trap is detuned into the passband, chopping out frequencies about 2 MHz below the picture carrier frequency. Switch to another channel carrying VITS. If the same thing is seen, then our reasoning is right, and the IF amplifier requires realignment.

If the poor response at 2 MHz is not seen on other channels, maybe an FM trap at the tuner input is misadjusted, causing a bite on only one channel. Other traps at the input of the set could similarly be misadjusted or faulty.

If the VITS response at the detector output is normal for all channels, the trouble will be in the video amplifier. Look for open peaking coils, off-value resistors, solder bridges across foil patterns, etc.

With dual-trace oscilloscope operation, the signal information on each vertical blanking interval can be viewed separately without trace overlapping, although the information alternates with each field. Fig. 25 indicates the oscilloscope control setting for viewing the alternate vertical blanking intervals.

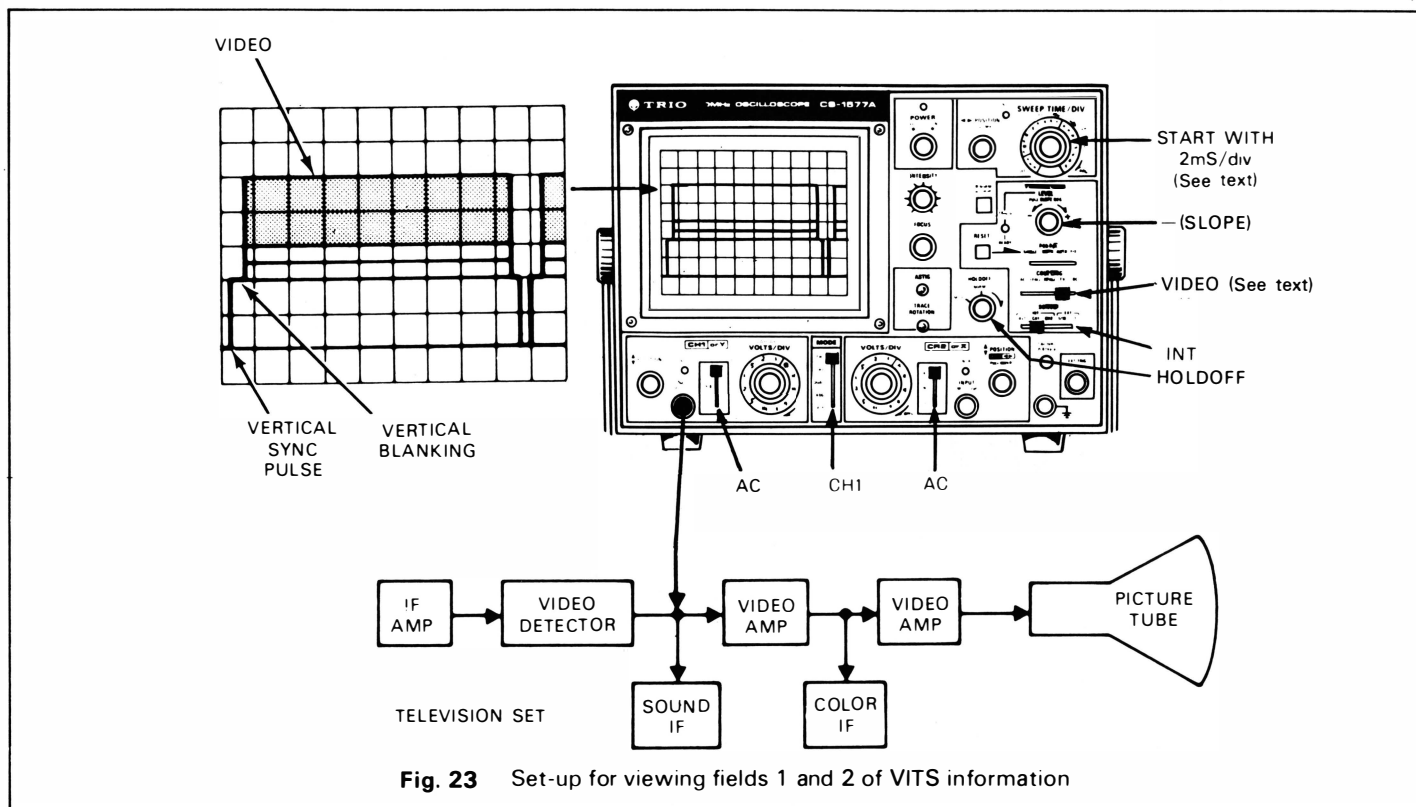

1. The color TV receiver on which the vertical interval information is to be viewed must be set to a station transmitting a color broadcast.
2. The control settings of Fig. 23 are those required to obtain 2-field vertical display on CH1.
3. With the oscilloscope and the TV receiver operating, connect the CH1 probe (set to 10 : 1) video detector test point .
4. Set the COUPLING and PULL SLOPE NEG switches as follows:
 - A. If the sync and blanking pulses of the observed video signal are positive, use slope + (LEVEL control pushed in).
 - B. If the sync and blanking pulses are negative, use slope - (LEVEL control pulled out).
5. Adjust the sweep time VARIABLE control so that 2 vertical fields are displayed on the oscilloscope screen.
6. Connect the CH2 probe (set to 10 : 1) to the video detector test point.
7. Set the MODE switch to DUAL position.
8. Place the sweep time VARIABLE in the CAL position.
9. Set the SWEEP TIME/DIV control to the 0.1ms/div position to expand the display by increasing the sweep speed. The VITS information will appear toward the right hand portion of the expanded waveform displays. The waveform information on each trace may appear as shown in Fig. 11. Because there is no provision for synchronizing the oscilloscope display to either of the two fields which comprise a complete vertical frame, it cannot be predicted which field display will appear on CH1 or CH2.
10. Pull the ◀ POSITION control outward to obtain an additional X5 magnification. Rotate the control in a counterclockwise direction moving the trace to the left until the expanded VITS information appears as shown in Fig. 21. Because of the low repetition rate and the high sweep speed combination, the brightness level of the signal displays will be reduced.

11. Once the CH1 and CH2 displays have been identified as being either Field 1 or Field 2 VITS information, the probe corresponding to the waveform display which is to be used for signal-tracing and troubleshooting can be used, and the remaining probe should be left at the video detector test point to insure that the sync signal is not interrupted. If the sync signal is interrupted, the waveform displays may be reversed because, as previously explained, there is no provision in the oscilloscope to identify either of the two vertical fields which comprise a complete frame.

With a video signal triggered, an oddfield may appear on an even field depending on the setting of sweep time. In this case, adjust the HOLDOFF until the fields are separated.

SINGLE-CHANNEL APPLICATIONS

Introduction:

In addition to the dual-trace applications previously outlined, there are, of course, many servicing and laboratory applications where only single-trace or single-channel operation of the oscilloscope is required.

Television Servicing:

A triggered sweep oscilloscope is advantageous in servicing and aligning television receivers. This oscilloscope also includes in addition, several features that were incorporated to make television servicing and VIDEO signal observation easier and more comprehensive. These features include:

- * With the SYNC switch set to VIDEO position, the SWEEP TIME/DIV control automatically selects the VIDEO-FRAME sync at sweep speeds appropriate for viewing frames and VIDEO-LINE horizontal sync at sweep speeds appropriate for viewing lines.
- * Wide bandwidth for high resolution video and high speed pulse presentation.

Single-trace Operation and Peak-to-peak Voltage Readings:

For general troubleshooting and isolation of troubles in almost any electronic equipment, the oscilloscope is an indispensable instrument. It provides a visual display of the absence or presence of normal signals. This method (signal-tracing) may be used to trace a signal by measuring several points in the signal path. As measurements proceed along the signal path, a point may be found where the signal disappears. When this happens, the source of trouble has been located.

However, the oscilloscope shows much more than the mere presence or absence of signals. It provides a peak-to-peak voltage measurement. The schematic diagram or accompanying service data on the equipment being serviced usually includes waveform pictures. These waveform pictures include the required sweep time and the normal peak-to-peak voltage. Compare the peak-to-peak voltage readings on the oscilloscope with those shown on the waveform pictures.

Any abnormal readings should be followed by additional readings in the suspected circuits until the trouble is isolated to as small an area as possible.

Composite Video Waveform Analysis:

Probably the most important waveform in television and video servicing is the composite waveform consisting of the video signal, the blanking pedestal signals and the sync pulses. Fig. 24 and Fig. 25 show typical oscilloscope traces when observing composite video signals synchronized with horizontal sync pulses and vertical sync pulses. Composite video signals can be observed at various stages of the television receiver to determine whether circuits are performing normally. Knowledge of waveform makeup, the appearance of a normal waveform, and the causes of various abnormal waveforms help the technician locate and correct many problems. The technician should study such waveforms in a television receiver known to be in good operating condition, noting the waveform at various points in the video amplifier.

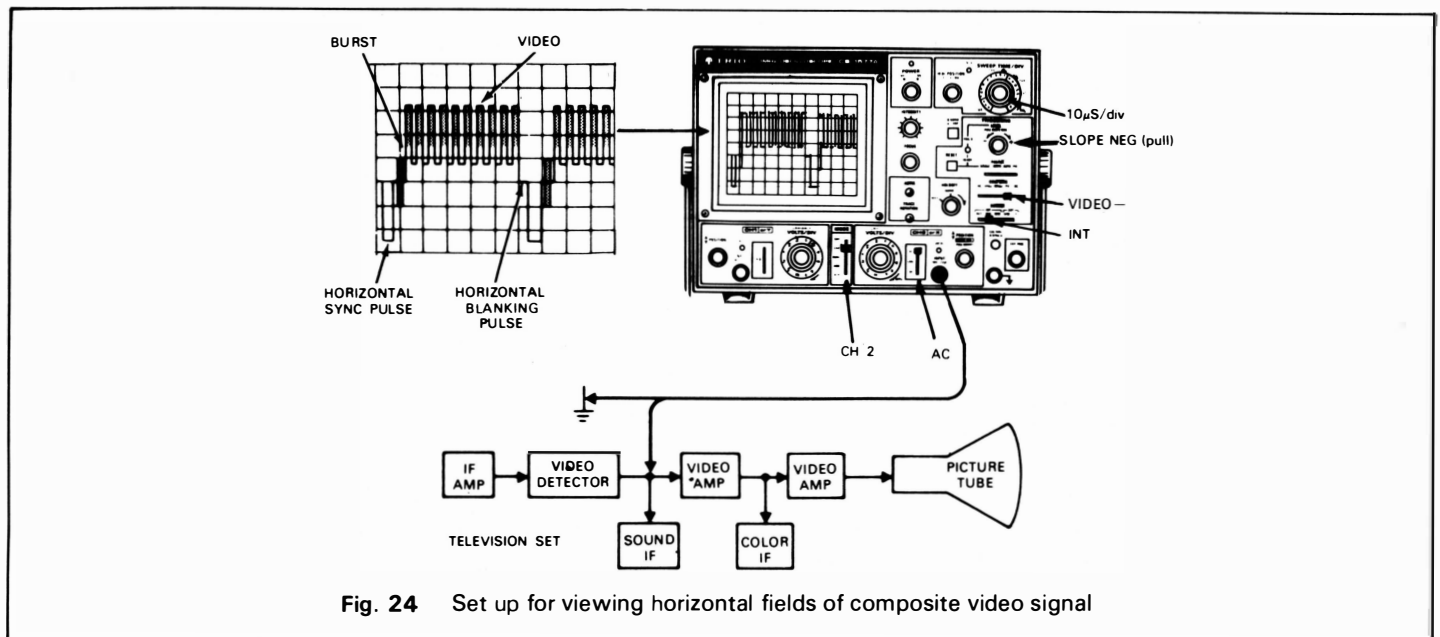

Fig. 24 Set up for viewing horizontal fields of composite video signal

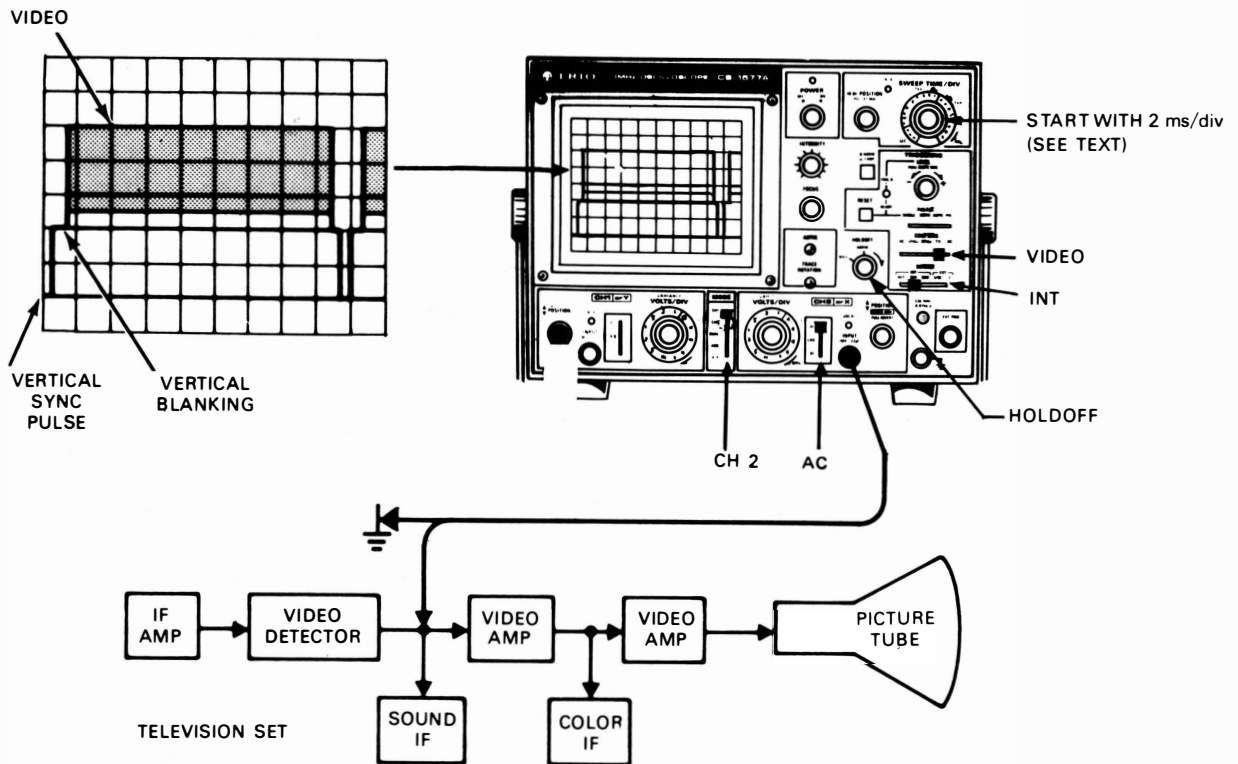

Fig. 25 Set-up for viewing vertical fields of composite video signal

To set up the oscilloscope for viewing composite video waveforms, use the following procedures:

1. Tune the television set or video recorder receiver to a local channel.
A test tape or a signal generator also can be used for service work.
2. Set the MODE switch to CH2 position.
3. Set the SWEEP TIME/DIV switch to the $10\mu\text{s}/\text{div}$ position for observing TV horizontal lines or to the $2\text{ms}/\text{div}$ position for observing TV vertical frames.
4. Set the COUPLING switch to the VIDEO position.
5. Set the SOURCE switch to the CH2 position.
6. Best overall sync performance is obtained in the NORM triggering mode. The AUTO triggering mode may be selected initially to provide continuous sweep during set-up.
7. Set the CH2 AC-GND-DC switch to the AC position.
8. Connect a probe cable to the CH2 INPUT jack. Connect the ground clip of the probe to the television. With the probe set for 10 : 1 attenuation, connect the tip of the probe to the video detector output.
9. Set the CH2 VOLTS/DIV switch for the largest vertical deflection possible without going off-scale.
10. Rotate the TRIGGERING LEVEL control to a position that provides a synchronized display.
11. Adjust the sweep time VARIABLE for two horizontal lines or two vertical frames of composite video display.
12. If the sync and blanking pulses of the displayed video signals are positive, leave the LEVEL control pushed in; if the sync and blanking pulses are negative, pull the LEVEL control to the PULL SLOPE NEG position.
13. If necessary, readjust the triggering LEVEL control to a position that provides a well-synchronised display.
14. Adjust the INTENSITY and FOCUS controls for the desired brightness and best focus.
15. To view a specific portion of the waveform, such as the color burst, pull the ◀▶ POSITION control for X5 magnification. Rotate the same control left or right to select the desired portion of the waveform to be viewed.
16. Composite video waveforms may be checked at other points on the video circuits by moving the probe tip to those points and changing the VOLTS/DIV control setting as required to keep the display within the limits of the scale, and by readjusting the TRIG LEVEL control to maintain stabilization. The polarity of the observed waveform may be reversed when moving from one monitoring point to another; therefore, it may be necessary to switch from slope + to slope -, or vice versa.

Sync Pulse Analysis:

The IF amplifier response of a television receiver can be evaluated to some extent by careful observation of the horizontal sync pulse waveform. The appearance of the sync pulse waveform is affected by the IF amplifier bandpass characteristics. Some typical waveform symptoms and their relation to IF amplifier response are indicated in Fig. 26. Sync pulse waveform distortions produced by positive or negative limiting in IF overload conditions are shown in Fig. 27.

CIRCUIT DEFECT	HORIZONTAL PULSE DISTORTION	OVERALL RECEIVER FREQUENCY RESPONSE	EFFECT ON PICTURE
NORMAL CIRCUIT			PICTURE NORMAL
LOSS OF HIGH FREQUENCY RESPONSE			LOSS OF PICTURE DETAIL
EXCESSIVE HIGH FREQUENCY RESPONSE NON-LINEAR PHASE SHIFT			FINE VERTICAL BLACK AND WHITE STRIATIONS FOLLOWING A SHARP CHANGE IN PICTURE SHADING
LOSS OF LOW FREQUENCY RESPONSE			CHANGE IN SHADING OF LARGE PICTURE AREAS SMEARED PICTURE

Fig. 26 Analysis of sync pulse distortion

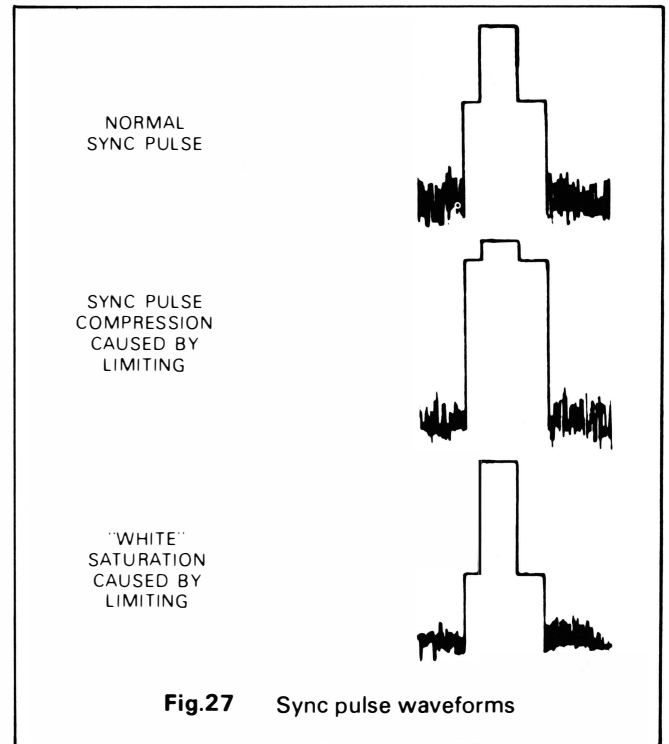

Fig.27 Sync pulse waveforms

FM RECEIVER ADJUSTMENTS

Procedure:

1. Connect a sweep generator to the mixer input of the FM receiver. Set the sweep generator for a 10.7 MHz centered sweep.
2. Connect the sweep voltage output of the sweep generator to the CH2 input jack of the oscilloscope and set the oscilloscope for X-Y operation.
3. Connect the vertical input probe to the demodulator input of the FM receiver.
4. Adjust the oscilloscope vertical and horizontal gain controls for a display similar to that shown in Fig. 28A.
5. Set the marker generator precisely to 10.7 MHz. The marker "pip" should be in the center of the bandpass.
6. Align the IF amplifiers according to the manufacturer's specifications.
7. Move the probe to the demodulator output. The "S" curve should be displayed, and the 10.7 MHz "pip" should appear exactly in the center (see Fig. 28B). Adjust the demodulator according to the manufacturer's instructions so the marker moves an equal distance from the center as the marker frequency is increased and decreased an equal amount from the 10.7 MHz center frequency.

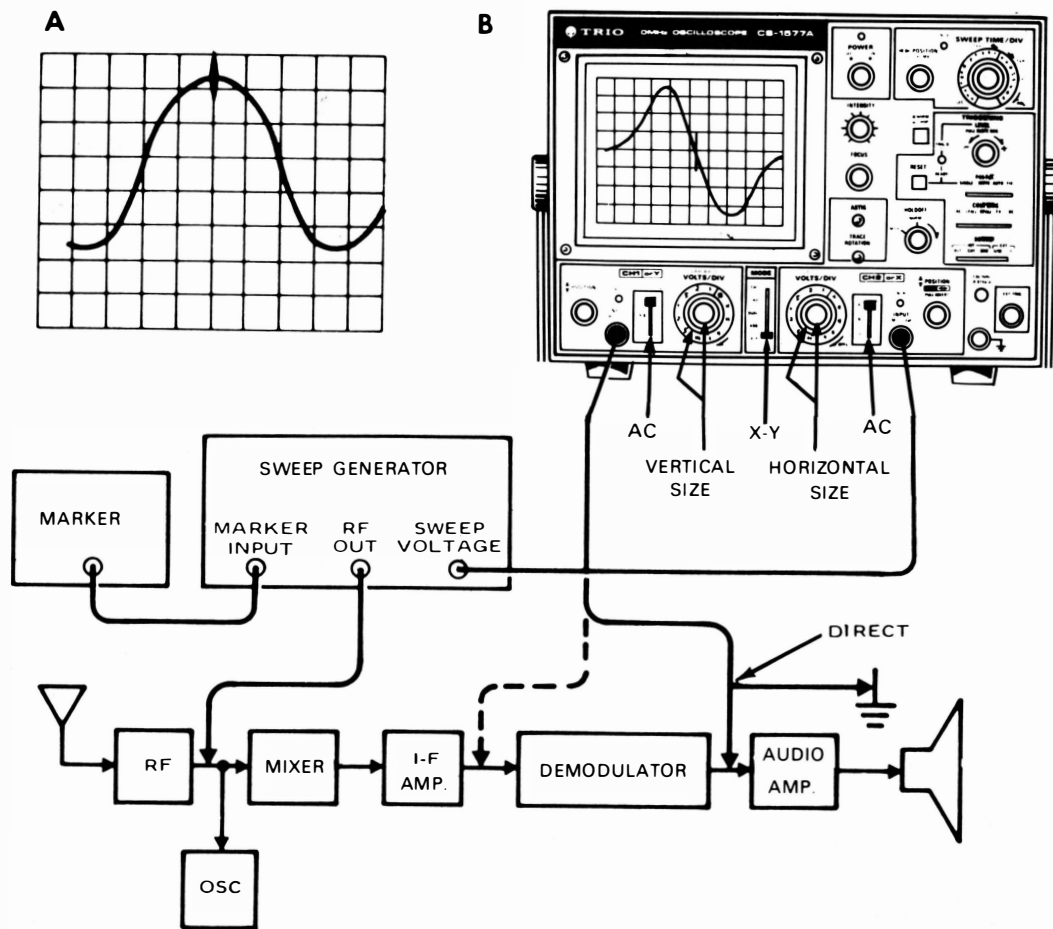

Fig. 28 Typical FM receiver alignment set-up

X-Y OPERATION

Phase Measurement:

Phase measurements may be made with an oscilloscope. Typical applications are in circuits designed to produce a specific phase shift, and measurement of phase shift distortion in audio amplifiers or other audio networks. Distortion due to non-linear amplification is also displayed in the oscilloscope waveform.

A sine wave input is applied to the audio circuit being tested. The same sine wave input is applied to the vertical input of the oscilloscope, and the output of the tested circuit is applied to the horizontal input of the oscilloscope. The amount of phase difference between the two signals can be calculated from the resulting waveform.

To make phase measurements, use the following procedures (refer to Fig. 29).

1. Using an audio signal generator with a pure sinusoidal signal, apply a sine wave test signal at the desired test frequency to the audio network being tested.
2. Set the signal generator output for the normal

operating level of the circuit being tested. If desired, the circuit's output may be observed on the oscilloscope. If the test circuit is overdriven, the sine wave display on the oscilloscope is clipped and the signal level must be reduced.

3. Connect the CH2 probe to the output of the test circuit.
4. Set the MODE to X-Y.
5. Connect the CH1 probe to the input of the test circuit. (The input and output test connections to the vertical and horizontal oscilloscope input may be reversed.)
6. Adjust the CH1 and CH2 gain controls for a suitable viewing size.
7. Some typical results are shown in Fig. 30. If the two signals are in phase, the oscilloscope trace is a straight diagonal line. If the vertical and a horizontal gain are properly adjusted, this line is at a 45° angle. A 90° phase shift produces a circular oscilloscope pattern. Phase shift of less (or more) than 90° produces an elliptical oscilloscope pattern. The amount of phase shift can be calculated from the oscilloscope trace as shown in fig. 31.

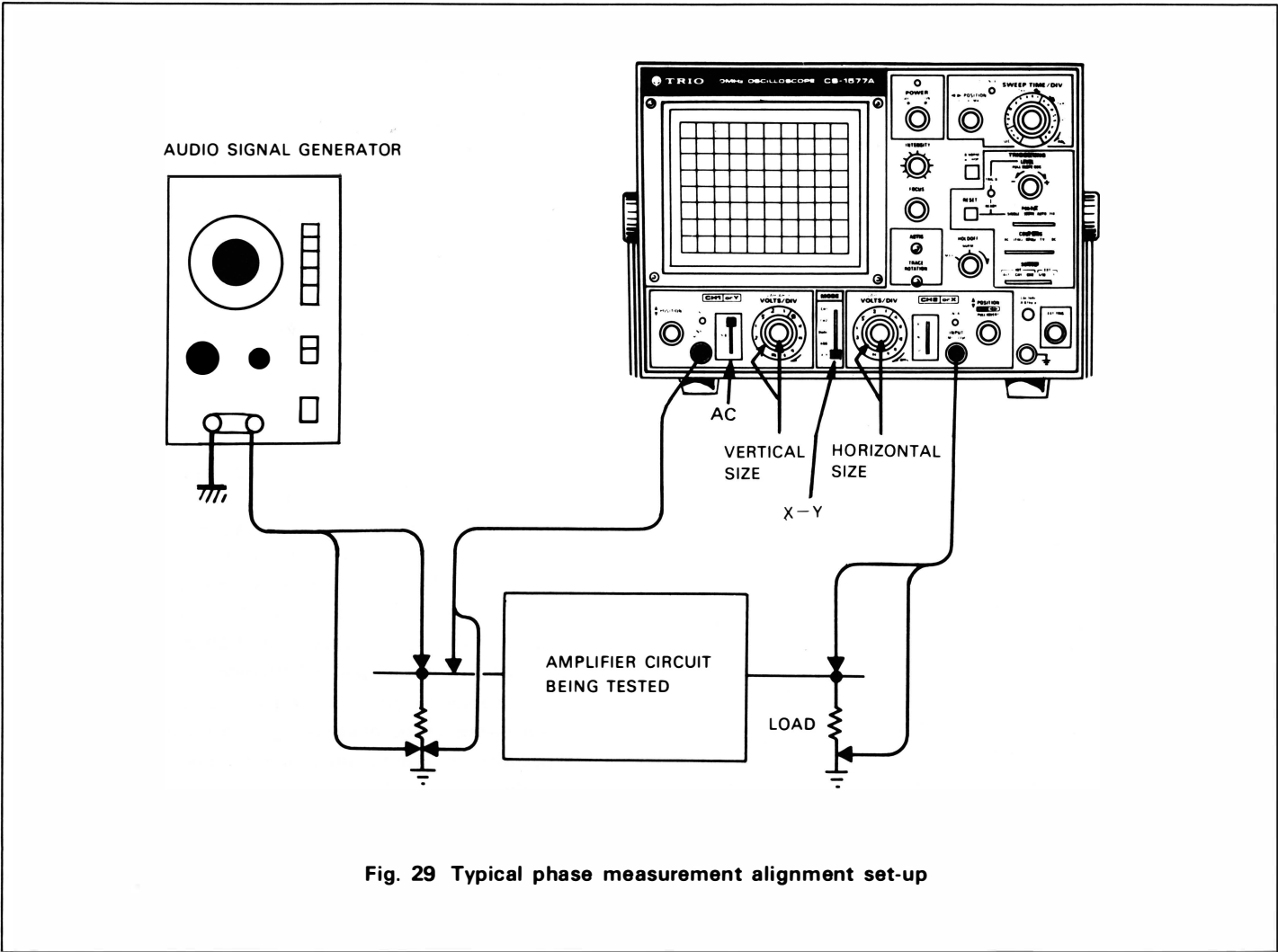

Fig. 29 Typical phase measurement alignment set-up

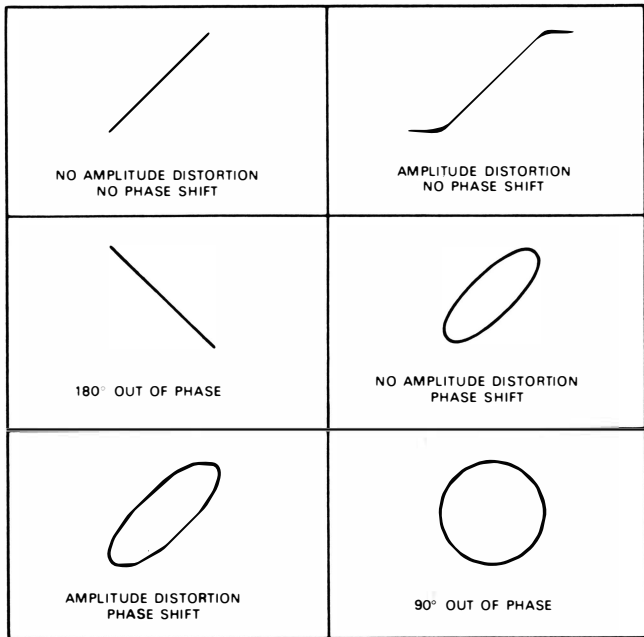

Fig. 30 Typical phase measurement oscilloscope displays

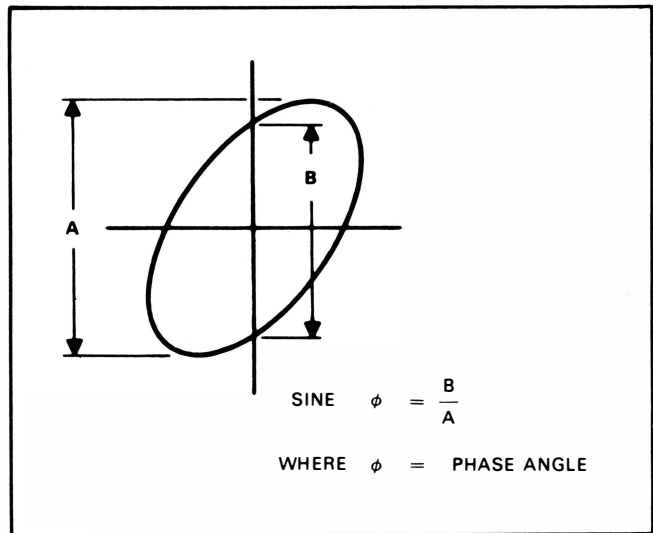

Fig. 31 Phase shift calculation

Frequency Measurement:

1. Connect the sine wave of known frequency to the CH2 input jack of the oscilloscope and set the MODE to X-Y.
2. Connect vertical input probe (CH1 INPUT) to the unknown frequency.
3. Adjust the CH1 and CH2 size control a convenient easy-to read size of display.
4. The resulting pattern called a Lissajous pattern, shows the ratio between the two frequencies (see Fig. 32).

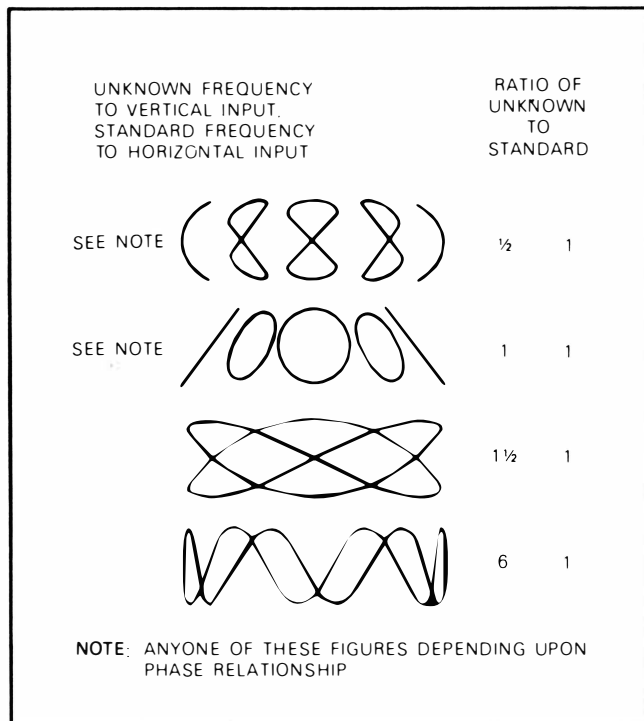

Fig. 32 Lissajous' waveforms used for frequency measurement

AMPLIFIER SQUARE WAVE TEST

Introduction:

A square wave generator and the oscilloscope, such as this oscilloscope can be used to display various types of distortion present in electronic circuits. A square wave of a given frequency contains a large number of odd harmonics of that frequency. If a 500 Hz square wave is injected into a circuit, frequency components of 1.5 kHz, 2.5 kHz and 3.5 kHz also are provided.

Since vacuum tubes and transistors are non-linear, it is difficult to amplify and reproduce a square wave which is identical to the input signal. Interelectrode capacitances, junction capacitances, stray capacitances as well as limited device and transformer response are a few of factors which prevent faithful reproduction of a square wave signal. A well-designed amplifier can minimize the distortion caused by these limitations. Poorly designed or defective amplifiers can introduce distortion to the point where their performance is unsatisfactory.

As stated before, a square wave contains a large number of odd harmonics. By injecting a 500 Hz sine wave into an amplifier, we can evaluate amplifier response at 500

Hz only, but by injecting a square wave of the same frequency we can determine how the amplifier would response to input signals from 500 Hz up to the 15th or 21st harmonic.

The need for square wave evaluation becomes apparent if we realize that some audio amplifiers will be required during normal use to pass simultaneously a large number of different frequencies. With a square wave, we have a controlled signal with which we can evaluated the input and output quality of a signal of many frequencies (the harmonics of the square wave) which is what the amplifier sees when amplifying complex waveforms of musical instruments or voices.

The square wave output of the signal generator must be extremely flat so that it does not contribute to any distortion that may be observed when evaluating amplifier response. The oscilloscope vertical input should be set to DC as it will introduce the least distortion, especially at low frequencies. When checking amplifier response, the frequency of the square wave input should be varied from the low end of the amplifier bandpass up toward the upper end of the bandpass; however, because of the harmonic content of the square wave, distortion will occur before the upper end of the amplifier bandpass is reached.

It should be noted that the actual response check of an amplifier should be made using a sine wave signal. This is especially important in an limited bandwidth amplifier (voice amplifies).

The square wave signal provides a quick check of amplifier performance and will give an estimate of overall amplifier quality. The square wave also will reveal some deficiencies not readily apparent when using a sine wave signal. Whether a sine wave or square wave is used for testing the amplifier, it is important that the manufacturer's specifications on the amplifier be known in order to make a better judgement of its performance.

Testing Procedure (refer to Fig. 33)

1. Connect the output of the square wave generator to the input of the amplifier being tested.
2. Connect the CH2 probe of the oscilloscope to the output of the amplifier being tested.
3. If the DC component of the circuit being tested is sufficiently low to allow both the AC and DC components to be viewed, use the DC position of AC-GND-DC switch. However, the AC position may be used without affecting the results except at very low frequencies. (below 10 Hz).
4. Adjust the vertical gain controls for a convenient viewing height.
5. Adjust the sweep time controls for one cycle of square wave display on the screen.
6. For a close-up view of a portion of the square wave, use the X5 magnification.

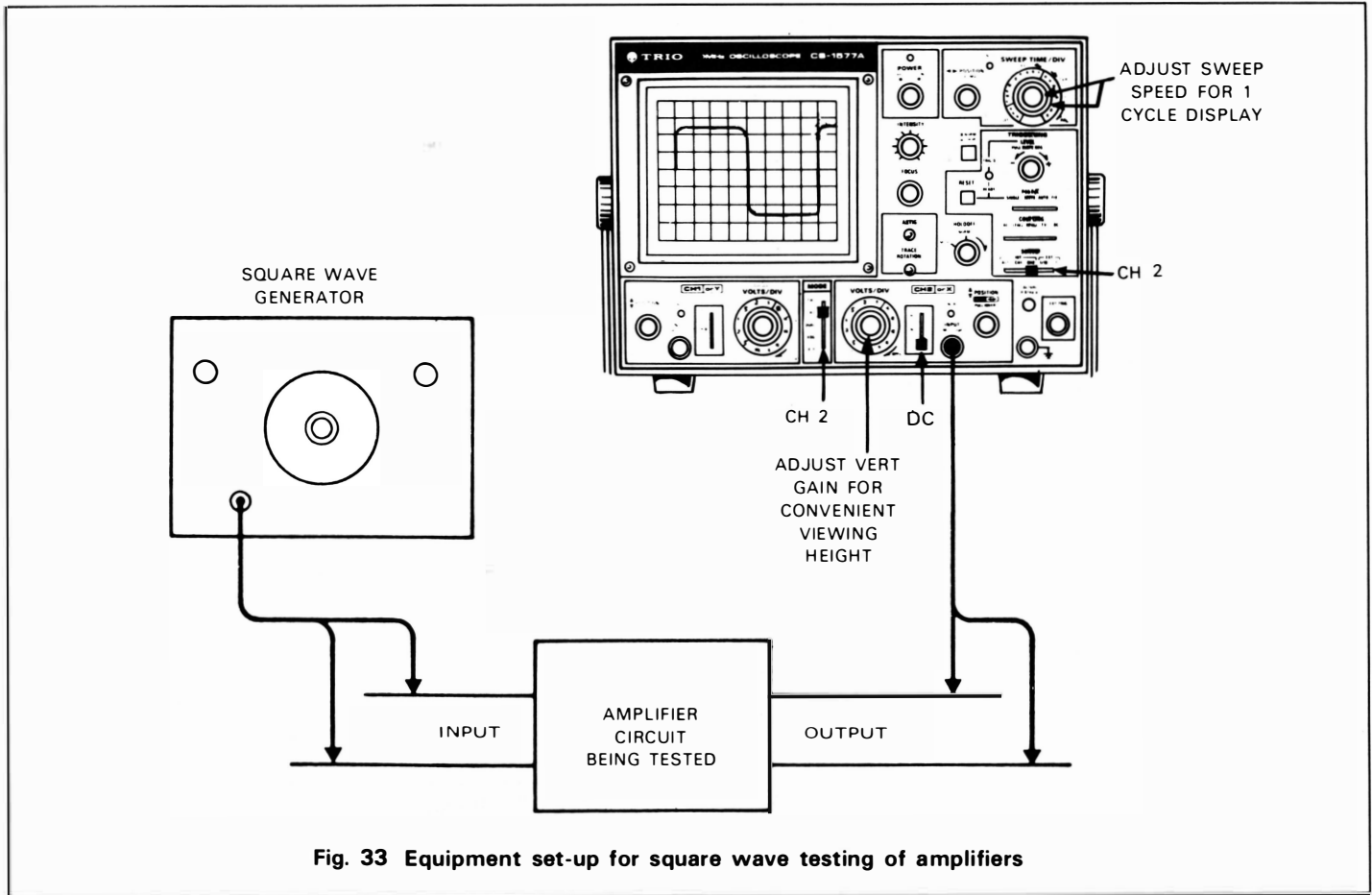

Analysing the Waveforms:

The short rise time which occurs at the beginning of the half-cycle is created by the in-phase sum of all the medium and high frequency sine wave components. The same holds true for the rapid drop at the end of the half-cycle from maximum amplitude to zero amplitude at the 180° or half-cycle point. Therefore, a theoretical reduction in amplitude alone of the high frequency components should produce a rounding of the square corners at all four points of one square wave cycle (See Fig. 34).

Distortion can be classified into the following three distinct categories:

1. The first is frequency distortion and refers to the change in the amplitude of a component of a complex waveform. In other words, the introduction in an amplifier circuit of resonant networks or selective filters created by combination of reactive components will create peaks or dips in an otherwise flat frequency response curve.
2. The second is non-linear distortion and refers to a change in waveshape produced by application of the waveshape to non-linear components or elements such as vacuum tubes, an iron core transformer, and in an extreme case, a deliberate non-linear circuit such as a clipper network.
3. The third is delay or phase distortion, which is distortion produced by a shift in phase between one or more components of a complex waveform.

In actual practice, a reduction in amplitude of a square wave component (sinusoidal harmonic) is usually caused by a frequency-selective network which includes capacity,

inductance or both. The presence of the C or L introduces a difference in phase angle between components, creating phase distortion or delay distortion. Therefore, in square wave testing of practical circuitry, we will usually find that the distorted square wave includes a combination of amplitude distortion and phase distortion clues.

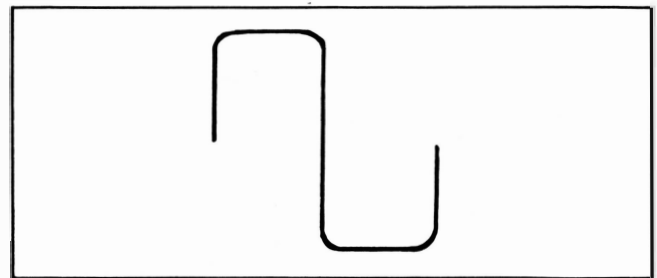

Fig. 34 Square wave response with high frequency loss

In a typical wide band amplifier, a square wave check reveals many distortion characteristics of the circuit. The response of an amplifier is indicated in Fig. 35, revealing poor low-frequency response along with the overcompensated high-frequency boost. A 100 Hz square wave applied to the input of this amplifier will appear as in Fig. 36A. This figure indicates satisfactory medium frequency response (approximately 1 kHz to 2 kHz) but shows poor low frequency response. Next, a 1 kHz square wave applied to the input of the amplifier will appear as in Fig. 36B. This figure displays good frequency response in the region of 1000 to 4000 Hz but clearly reveals the over compensation at the higher 10 kHz region by the sharp rise at the top of the leading edge of the square wave.

As a rule of thumb, it can be safely said that a square wave can be used to reveal response and phase relationships up to the 15th or 20th odd harmonic or up to approximately 40 times the fundamental of the square wave. Using this rule of thumb it is seen that wide-band circuitry will require at least two frequency check points to properly analyze complete spectrum.

In the case illustrated by Fig. 35, a 100 Hz square wave will encompass components up to about 4 kHz.

Now, the region between 100 Hz and 4000 Hz in Fig. 37 shows a rise from poor low-frequency (100 Hz to 1 kHz) response to a flattening out from beyond 1000 and 4000 Hz. Therefore, we can expect that the higher frequency components in the 100 Hz square wave will be relatively normal in

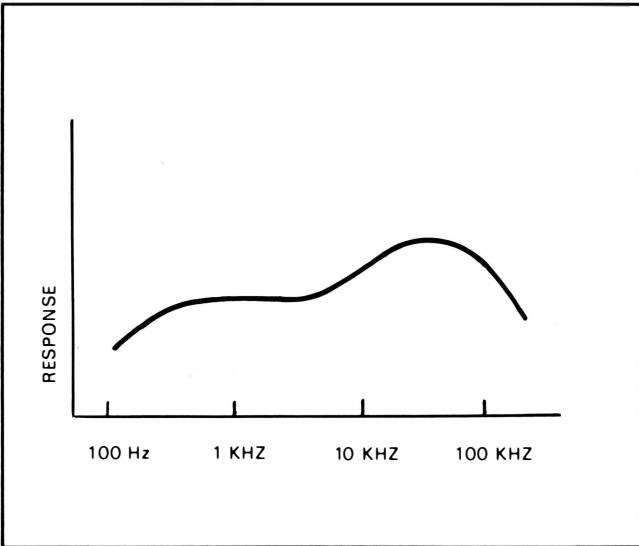

Fig. 35 Response curve of amplifier with poor low and high ends

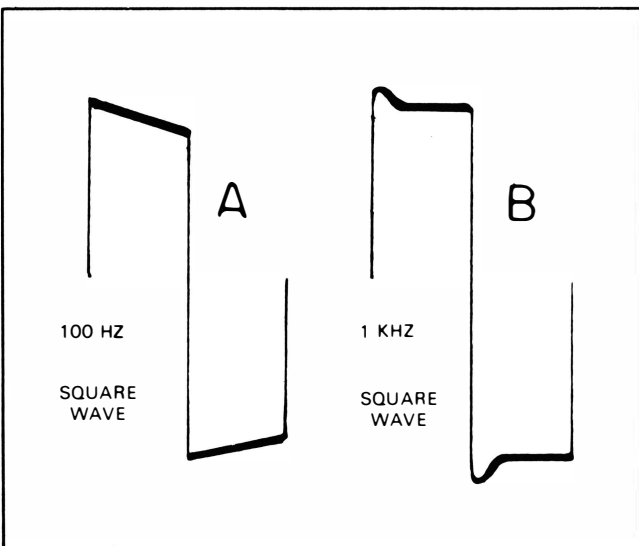

Fig. 36 Resultant 100 Hz and 1 kHz square waves from amplifier in Fig. 35

amplitude and phase but that the lower-frequency components in this same square wave will be strongly modified by the poor low-frequency response of this amplifier (see Fig. 27).

If the combination of elements in this amplifier were such as to only depress the low frequency components in the square wave, a curve similar to Fig. 37 would be obtained. However, reduction in amplitude of the components is usually caused by a reactive element, causing in turn, a phase shift of the components, producing the tilt strong as shown in Fig. 36A.

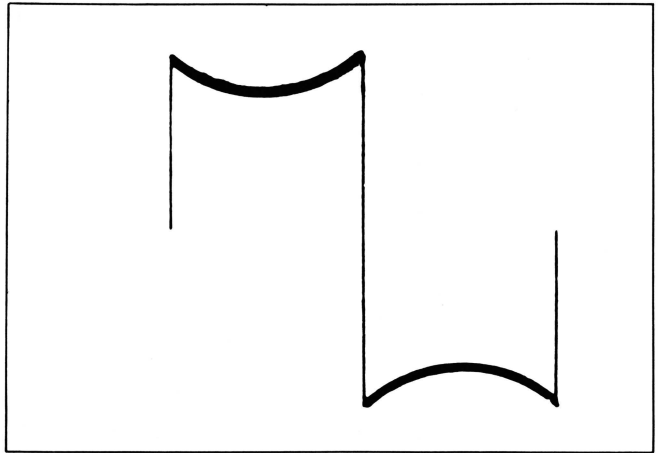

Fig. 37 Reduction of square wave fundamental frequency component in tuned circuit

Fig. 38 reveals a graphical development of a similarly tilted square wave. The tilt is seen to be caused by the strong influence of the phase-shifted 3rd harmonic. It also becomes evident that very slight shifts in phase are quickly shown up by tilt in the square wave.

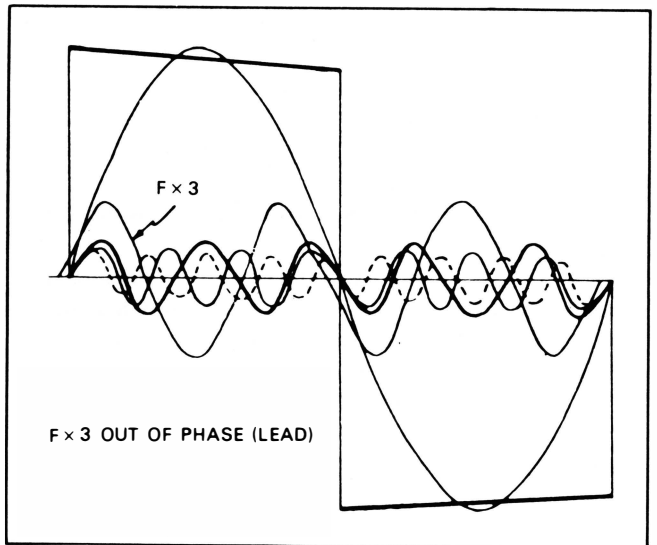

Fig. 38 Square wave tilt resulting from 3rd harmonic phase shift

Fig. 39 indicates the tilt in square wave produced by a 10° phase shift of a low-frequency element in a leading direction. Fig. 40 indicates a 10° phase shift in a low frequency component in a lagging direction. The tilts are opposite in the two cases because of the difference in polarity of the phase angle in the two cases as can be checked through algebraic addition of components.

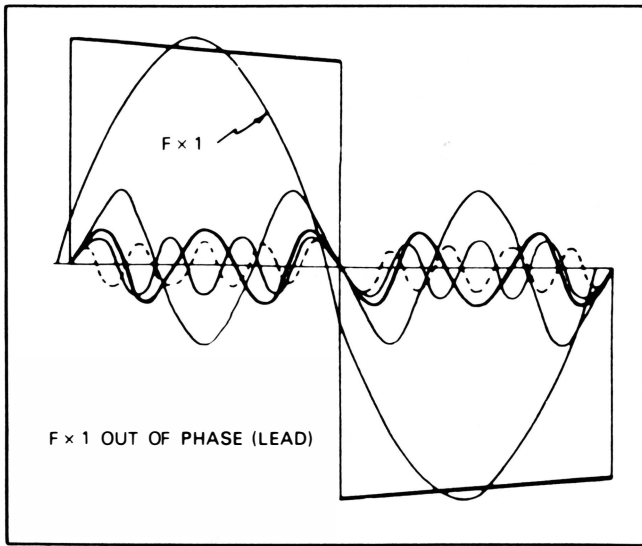

Fig. 39 Tilt resulting from phase shift of fundamental frequency in a leading direction

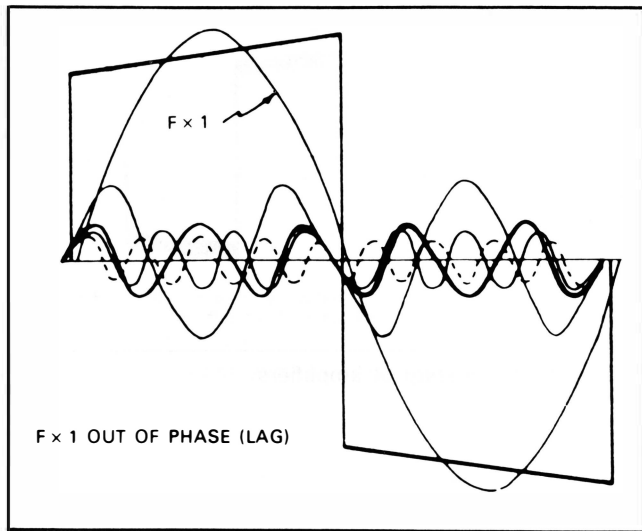

Fig. 30 Tilt resulting from a phase shift of fundamental frequency in a lagging direction.

Fig. 41 indicates low-frequency components which have been reduced in amplitude and shifted in phase. It will be noted that these examples of low-frequency distortion are characterized by change in shape of the flat top portion of the square wave.

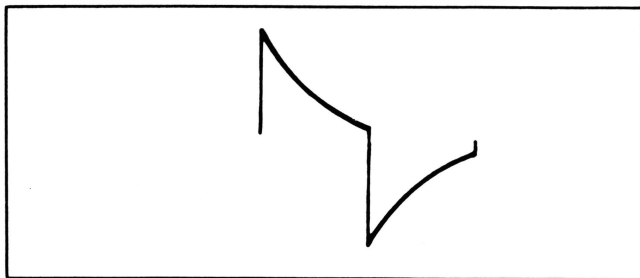

Fig. 41 Low frequency component loss and phase shift

Fig. 36B previously discussed, revealed a high-frequency overshoot produced by rising amplifier response at the high or frequencies. It should again be noted that this overshoot makes itself evident at the top of the leading edge of the square wave. This characteristic relationship is explained by remembering that in a normal well-shaped square wave, the sharp rise of the leading edge is created by the summation of a practically infinite number of harmonic components. If an abnormal rise in amplifier response occurs at high frequencies, the high frequency components in the square wave will be amplified larger than other components creating a higher algebraic sum along the leading edge.

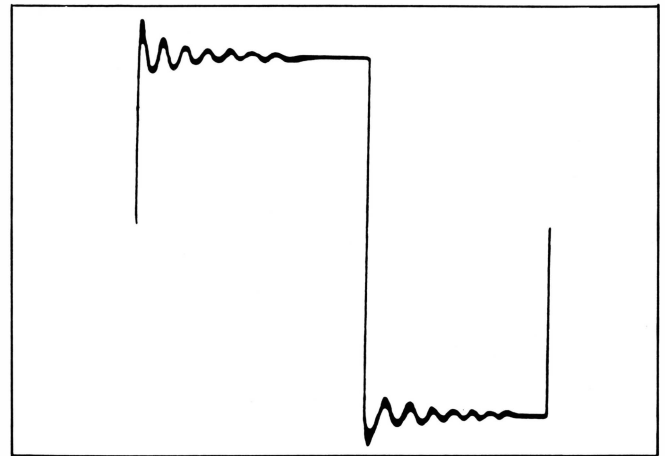

Fig. 42 Effect of high-frequency boost and poor damping

Fig. 42 indicates high frequency boost in an amplifier accompanied by a lightly damped "shock" transient. The sinusoidal type of diminishing oscillation along the top of the square wave indicates a transient oscillation in a relatively high "Q" network in the amplifier circuit. In this case, the sudden transition in the square wave potential from a sharply rising, relatively high frequency voltage, to a level value of low frequency voltage, supplies the energy for oscillation in the resonant network. If this network in the amplifier is reasonably heavily damped, then a single cycle transient oscillation may be produced as indicated in Fig. 43. Fig. 44 summarizes the preceding explanations and serves as a handy reference.

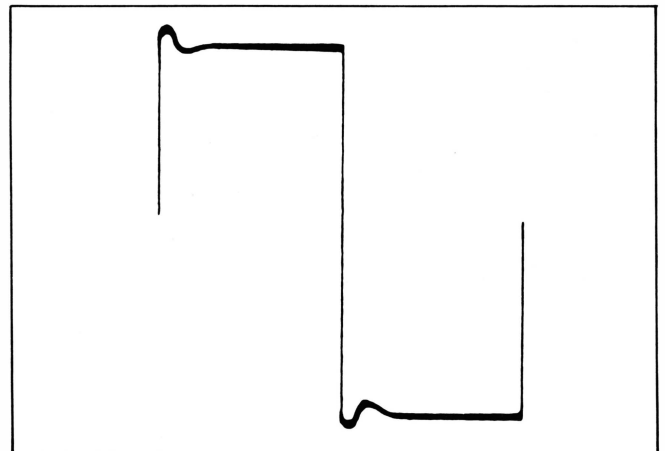

Fig. 43 Effect of high-frequency boost and good damping

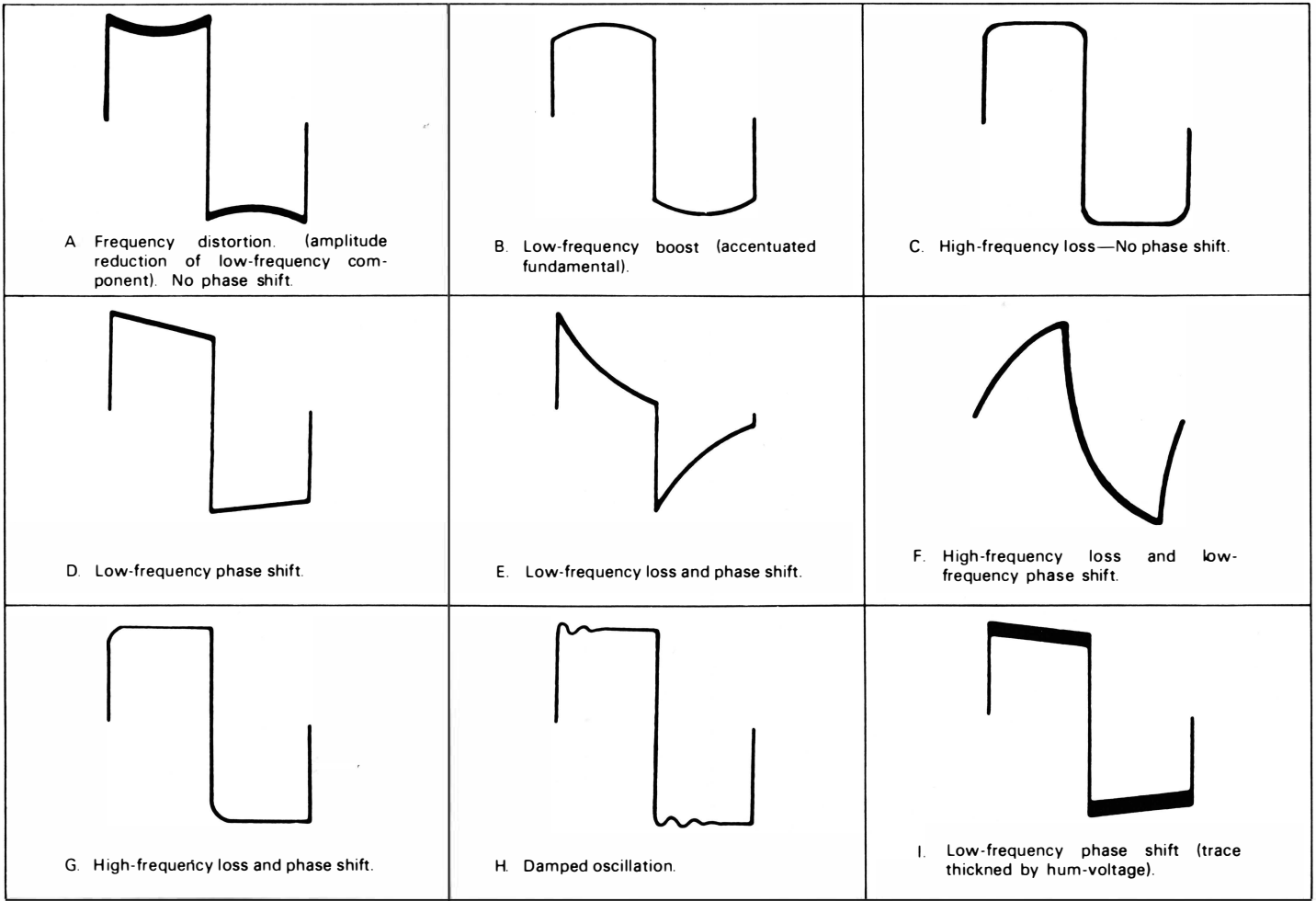

Fig. 44 Summary of waveform analysis for square wave testing of amplifiers

PRECAUTIONS

1. Avoid using the oscilloscope in a location exposed to direct sunlight.
2. Select a place free from high temperature and humidity. Do not use the oscilloscope in a dusty location.
3. Do not operate the oscilloscope in a place where mechanical vibrations are excessive or a place near equipment which generates strong magnetic fields or impulse voltages.
4. This oscilloscope is factory set for AC 240V operation. For AC 100V, 117V or 220V operation, change the position of the plug of the voltage selector at the rear panel as indicated by the arrow. When the oscilloscope is to be operated with AC 100V, 117V, be sure to replace the fuse with one rated at 0.8A.
5. Do not apply input voltages exceeding their maximum ratings. The input voltage to the vertical amplifier is up to 250V (DC + AC peak), the input for EXT. TRIG is up to 50V (DC + AC peak), and the input to Z AXIS is up to 50V (DC + AC peak).
6. Do not increase the brightness of the CRT unnecessarily.
7. Do not leave the oscilloscope for a long period with bright spot displayed on CRT. Reduce the brightness and soften the focus.
8. For X-Y operation, use the PULL X5 MAG switch in the PUSH position. If it is set in the PULL position, noise may appear in the waveform.

9. Setting the oscilloscope

Do not place any object on the oscilloscope or cover the ventilation holes of the case with a cloth or the like, as it will increase the temperature inside the case.

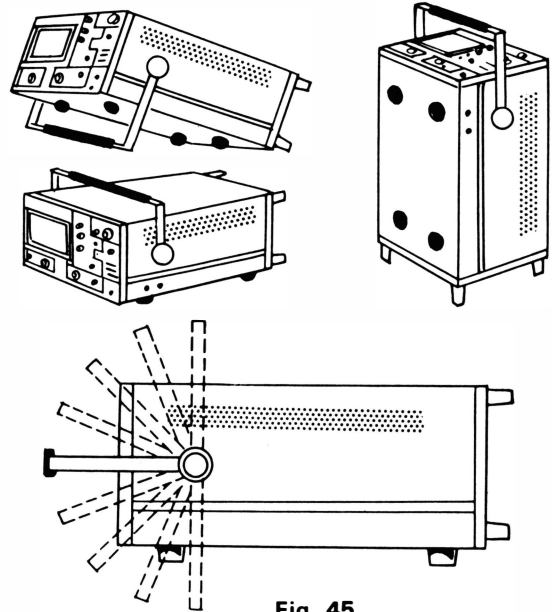

Fig. 45

MAINTENANCE AND ADJUSTMENT

MAINTENANCE

CRT trace angle adjustment.

Adjust the TRACE ROTATION (front panel) until the trace is aligned with the horizontal line marked on the CRT scale.

Removing the case:

1. Remove the seven screws from the top and side walls of the case, using a Phillips head screwdriver.

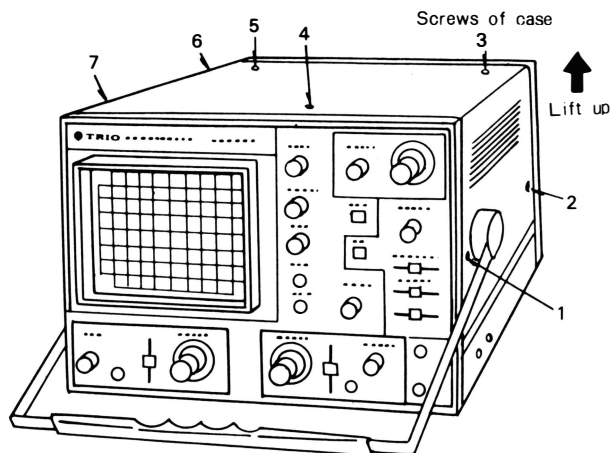

Fig. 46

2. Hold the handle and lift up. The case is now ready for removal.
3. To remove the bottom plate, unscrew the four screws using a Phillips head screwdriver.

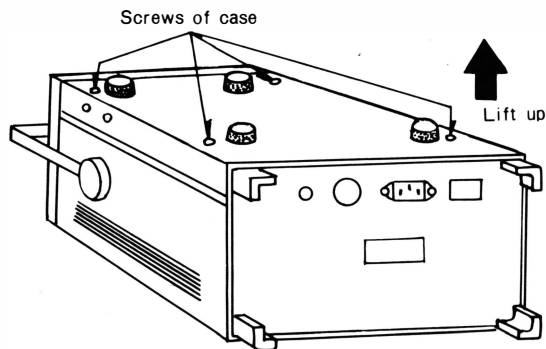

Fig. 47 Removal of bottom plate

Caution: A high voltage (6000V) is present at the CRT socket. Before removing the case, be sure to turn off the power, and do not touch these parts with your hand or a screwdriver even after the case has been removed.

AC Voltage selector:

The oscilloscope may be operated from 100V, 117V, 220V, 240V, putting the AC voltage selector in place of another. (Refer to Fig. 48)

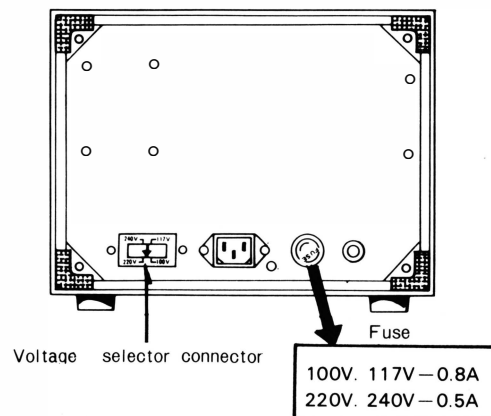

Fig. 48

ADJUSTMENT

Observe the following before making adjustments:

The oscilloscope is factory adjusted prior to shipment. If readjustment becomes necessary, the following points should be observed.

1. Check the power supply is the correct voltage.
2. For adjustments, use a well insulated screwdriver.
3. Before marking adjustments, be sure to turn on the power and wait until the unit is stabilized.
4. For adjustment, follow the procedures described below.
5. If special test instruments are required for adjustments, contact your local Trio service station.

Adjustment of Power Supply and CRT Circuits:

1. Adjustment of low power voltage (Fig. 49)
Measure the voltage at the No. 10 pin of P505 and adjust VR501 for $+130V \pm 1\%$.
Next, check that voltages on No. 4, 7 and 8 pins of P505 are $+5V$, $-12V$ and $+12V$, respectively.
2. Intensity adjustment (Fig. 49)
With INTENSITY knob set in the left (horizontal) position, adjust VR602 until the trace disappears, then adjust TC601 so that the brightness at the sweep starting point is the same as the brightness at other points (SWEEP TIME/DIV in $0.2\mu s$ position). Finally, adjust the spot with FOCUS and ASTIG.

Adjustment of CH1 Vertical Circuit:

Before making adjustments, set the knobs of oscilloscope as follows:

MODE CH1 position
VOLTS/DIV 2mV/div position

5. CRT Center Adjustment (Fig. 49 and 51).
Short test terminal TP4 to TP5, adjust VR702 to center the trace vertically.
6. VARIABLE ATT DC BAL Adjustment (Fig. 50)
Adjust VR101 so that the trace stays still at any position of VARIABLE of VOLTS/DIV.
7. STEP ATT DC BAL Adjustment (Fig. 50)
Adjust VR103 so that the trace stays still at any position of VOLTS/DIV.
8. POSITION Adjustment (Fig. 49)
With POSITION knob set in the mechanical center position, adjust VR104 until the trace is centered on CRT.

Adjustment of CH2 Vertical Circuit:

Before making adjustments, set the knobs of oscilloscope as follows:

MODE CH2 position
VOLTS/DIV 2mV/div position

9. VARIABLE ATT DC BAL Adjustment (Fig. 50)
Adjust VR108 until the trace stays still at any position of VARIABLE of VOLTS/DIV.
10. STEP ATT DC BAL Adjustment (Fig. 50)
Adjust VR110 until the trace stays still at any position of VOLTS/DIV.
11. POSITION Adjustment (Fig. 49)
With POSITION knob set in the mechanical center position, adjust VR112 until the trace is centered on CRT. Next, set PULL INVERT in PULL position and adjust VR111 in the same manner.

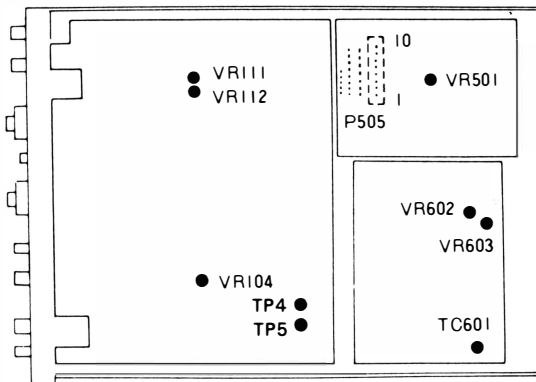

Fig. 49 Bottom View

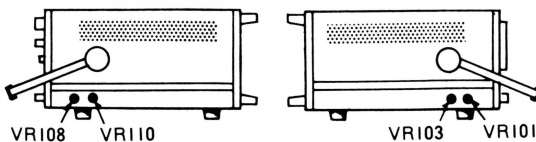

Fig. 50

Horizontal Circuit Adjustment:

12. ◀▶ POSITION Adjustment (Fig. 52)
With ◀▶ POSITION knob set in the mechanical center position, adjust VR306 so that the start point of trace is at the left end of the scale.
13. X POSITION Adjustment (Fig. 52)
With MODE set to X-Y and X axis (CH2) input to GND, adjust VR307 until the spot is centered on the screen.

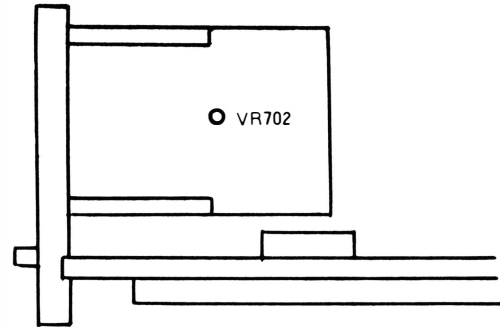

Fig. 51

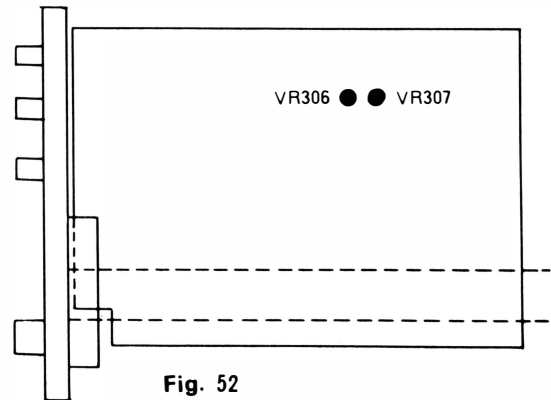
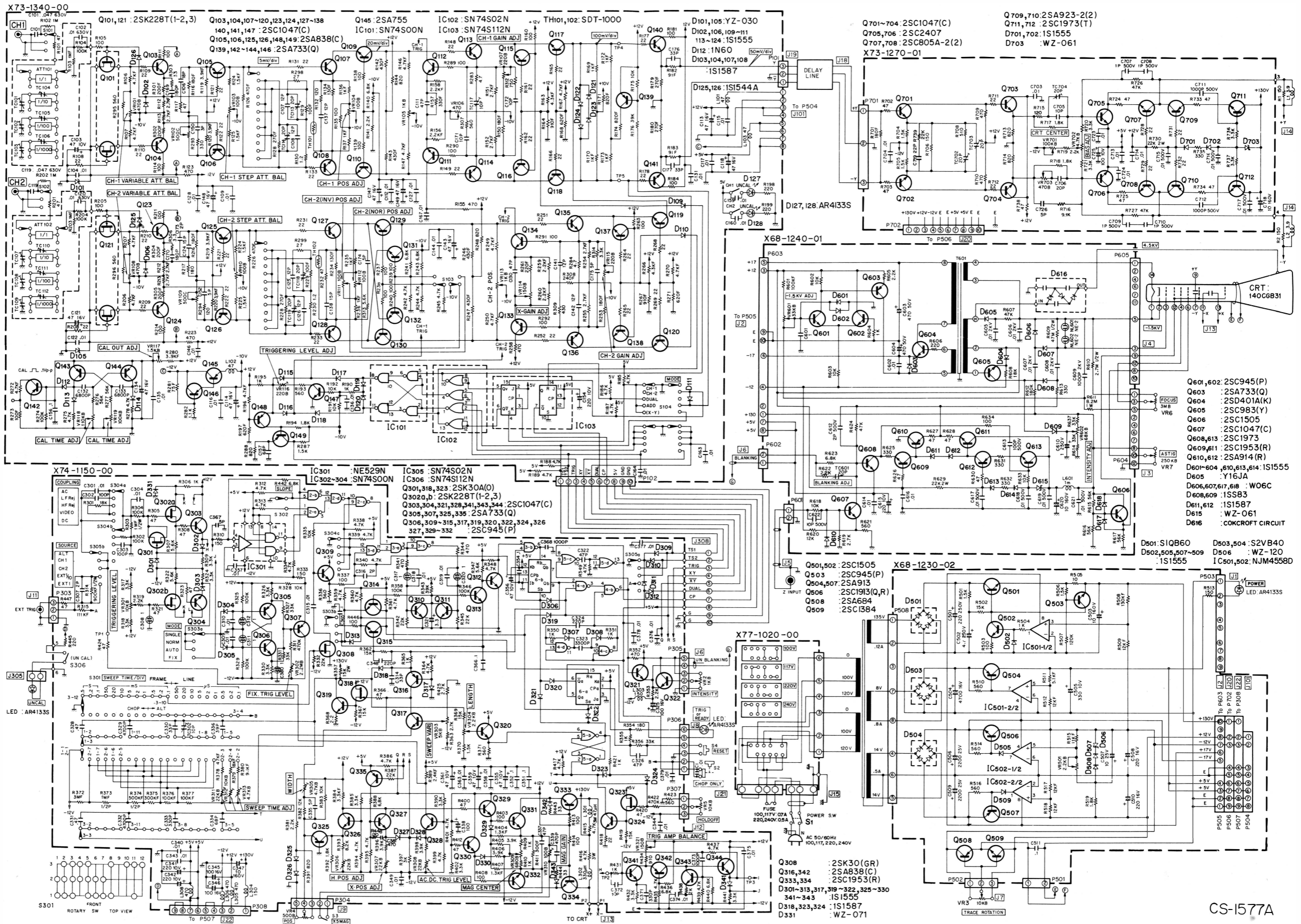

Fig. 52

SCHEMATIC DIAGRAM



CS-1577A

A product of
TRIO-KENWOOD CORPORATION

17-5, 2-chome, Shibuya, Shibuya-ku, Tokyo 150, Japan
