

MFJ

Sound Card Radio Interface

Model MFJ-1275/1275M/1275T



INSTRUCTION MANUAL

CAUTION: Read All Instructions Before Operating Equipment

MFJ ENTERPRISES, INC.

300 Industrial Park Road
Starkville, MS 39759 USA
Tel: 662-323-5869 Fax: 662-323-6551

SOFTWARE CONSIDERATIONS

SHAREWARE

The CD that comes with your MFJ-1275/1275M/1275T contains shareware. This CD will automatically run the *MFJ Sound Card Interface Software Installation Menu* upon startup. If, for some unforeseen reason, your CD does not automatically run you must manually invoke it. To do this, follow the steps listed below.

1. With the Shareware CD in the CD drive, click on the Start button at the bottom left of the screen.
2. Click on RUN. This will bring up a command window.
3. Click the Browse button.
4. When the browse window is open, double click on the CD drive.
5. Double click on the autorun.exe program.
6. The autorun.exe program will now show up in the command window.
7. Click OK and the *MFJ Sound Card Interface Software Installation Menu* will begin to run.

From the menu, you may choose which shareware program(s) to install. Though effective, this software is limited in its uses. To get the full experience with your unit, MFJ recommends that you purchase either the MFJ-1296 or the MFJ-1298 Sound Card Program.

The sound card programs on the provided CD are as we said before, “**SHAREWARE**”. If there are problems with the software, then you need to contact the author of the program that you are trying to use. MFJ Enterprises provides only *limited support* for these shareware programs.

MFJ-1296 & MFJ-1298 SOFTWARE PACKAGES

The MFJ-1296, RadioCom4, and the MFJ-1298, RadioCom5, are the best programs for soundcard interfaces and amateur radio.

Some features of the MFJ-1296 and the MFJ-1298 include:

- PSK: Supports PSK-31, Q and B PSK
- SSTV: 32-bit color, supports all SSTV formats, screen sizes/SSTV parameters are all variable.
- FAX: Supports AM/FM bands. Includes Weather FAX and satellite FAX direct. Supports ICO 267, 288, 352, and 567. RPM 48, 60, 90, 120, 180, and 240. FAX resolution is up to 1810 dpi, FAX features IOC and slant-correction. FAX pictures can be saved, printed, retransmitted.
- CW: Features automatic speed tracking, DSP notch and bandpass filters.
- RTTY: Supports all standard shifts and speeds. X/Y scope and frequency spectrum display makes tuning RTTY a breeze. Also supports NAVTEX, European SYNOP, Baudot, and Sitor-B.
- Radio control for over 80 radios.
- DSP Audio Filters and Analyzer.
- RS-232 Level Converter.

The MFJ-1298 has additional features that include Spectrum Analyzer, Dual Scope Display, Sound Recorder, Time/Frequency Management, Frequency Analyzer, 3-D Scanner, Satellite Tracking, and much more!

The MFJ RadioCom requires a computer with a minimum 200 MHz, Pentium/Celeron processor, at least 64 MB of RAM, and Microsoft @Windows95/98/ME/2000/NT/XP operating system.

These fully integrated software packages can be purchased from MFJ and are fully supported by MFJ.

TABLE OF CONTENTS

Introduction	2
1.0 Powering the MFJ-1275/1275M/1275T.....	3
2.0 Connecting the MFJ-1275/1275M/1275T.....	3
3.0 MFJ-1275T Special Instructions	4
4.0 Microphone and Radio Connections (MFJ-1275/1275M).....	5
4.1 Internal Header and Jumper Connection Description	5
4.2 Jumper Diagrams (MFJ-1275/1275M).....	6
4.3 Customizing Internal Jumpers (MFJ-1275/1275M).....	9
4.4 Audio Termination Jumpers (JMP1, JMP2)	10
5.0 Rear Panel Connections	10
5.1 Computer RS-232 port/USB Port.....	10
5.2 Radio	10
5.3 Computer	11
5.4 GND	11
6.0 Operating Suggestions.....	11
6.1 Placement of this Unit.....	11
6.2 Hum, Squeals, and Distortion	12
6.3 Operating Adjustments.....	12
6.4 Monitoring Receiver (SSTV, Voice Keyer)	13
7.0 Software	13
8.0 Troubleshooting Guide.....	13
9.0 Technical Assistance	14
10.0 Schematic	15

INTRODUCTION

Thank you for purchasing the MFJ-1275/1275M/1275T) *Sound Card Radio Interface*. The MFJ-1275/1275M/1275T was designed for use in all sound card to radio applications. Great care was taken to make sure hum, noise, and distortion are minimized or eliminated, insuring the best possible signal from your equipment.

Before attempting to use the MFJ-1275T, please read section 3.0. Before attempting to use the MFJ-1275/1275M, please read section 4.0. This section contains important information about interfacing the MFJ-1275/1275M with your transceiver. We will start with a brief introduction into the special features that make your *Sound Card Radio Interface* an important addition to any computer station.

MFJ-1275/1275M/1275T Features:

Serial Port: This port allows the computer to control the push-to-talk of your radio and the microphone push-to-talk switch to override and/or interrupt your computer's transmission.

Microphone/Radio plug-in jumpers: Internal jumpers program microphone wiring for any brand or model of radio with the appropriate 8-pin connector. There is no need to solder tiny plugs and wires or purchase adapters.

PTT Message Interrupt/Stop: Microphone PTT (push-to-talk) switch automatically halts outgoing messages when using software that allows external com-port interrupts. Even if software does not allow interrupts, you can still hold the microphone PTT to stop digital transmissions and transmit microphone audio.

Radio/Speaker-Computer/Speaker switching: This transfers audio lines with a touch of the ON/BYPASS switch. No need to move cables every time you change use of the computer or radio. NOTE: Requires you use external speaker on radio.

Off-Air Recording: Capture signals from your receiver's audio jack for review or replay, or use with spectrum analyzer programs.

RFI Proof Circuitry: RF suppression and line isolation virtually eliminates RF feedback, hum, and distortion. An isolation transformer prevents audio ground loops.

Level controls: Two level controls, one for transmitter drive and one for receiver-to-sound card drive level. No need to adjust microphone gain or sound card level settings every time you change modes.

Stereo or Mono Audio input: A front-panel switch selects left, right, or both sound card audio output channels.

Rugged Construction: A solid all aluminum cabinet and sturdy surface-mount construction gives the MFJ-1275/1275M/1275T mechanical and electrical durability.

1.0 POWERING THE MFJ-1275/1275M/1275T

External Power: Use any well filtered power source capable of supplying 12-15 Vdc at 100 mA. The minimum operating voltage is 10 Vdc. Under a full load, sources exceeding 16 Vdc may permanently damage this product. The external power jack, of the Sound Card Radio Interface, accepts a standard 2.1mm coaxial power plug. *The power plug's center pin must be positive (+) and ground-isolated.* The outer shell is negative (-) and may be grounded or floated at the supply. When connecting to a high current supply (more than one ampere), we strongly recommend fuse protecting both positive and negative supply leads with ½ ampere to 1 ampere fast-blow fuses.

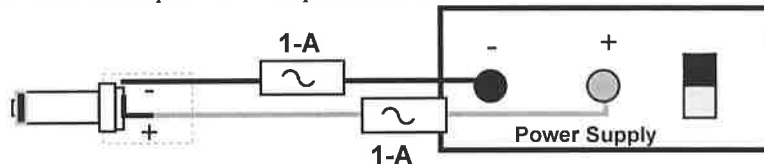

WARNING: Never insert the power plug with power applied—an accidental short from (+) to chassis ground may result. Also, never allow the MFJ-1275/1275M/1275T supply voltage to exceed 16 Vdc. Connections to high current power sources must be fuse protected!

MFJ-1312D Power Supply: The MFJ-1312D wall adapter is also suitable for powering your Sound Card Radio Interface. It comes with the correct 2.1mm power plug installed, and is available directly from MFJ Enterprises, Inc. or through your local MFJ dealer.

2.0 CONNECTING THE MFJ-1275/1275M/1275T

FRONT PANEL:

MICROPHONE	Accepts standard 8-pin microphone plug (8-pin modular for the MFJ-1275M) (4-pin for the MFJ-1275T)
INPUT	Selects left, both, or right sound card audio channel
MANUAL/VOX	Selects PTT control from COM port or VOX operation
ON/BYPASS	Selects computer audio and control (ON) or normal operation of computer and radio (BYPASS)
XMIT	Illuminates when computer transmitting or ready to transmit (VOX) with audio input
POWER	Illuminates when unit is in ON mode
MONITOR/OFF	Allows the user to listen through the radio speakers while at the same time being routed through the Sound Card Radio Interface

REAR PANEL:

POWER Requires 12-15 Vdc @ 100mA (16 volt absolute maximum)

**COMPUTER
RS-232** DB-9 female serial (COM port) connection

RADIO

TO EXT SPKR 3.5mm mono jack connects to station loudspeaker or other audio accessories normally connected to radio speaker jack

TO RADIO MIC 3.5mm mono jack connects to external speaker output of radio

COMPUTER

**TO SOUND CARD
AUDIO IN** 3.5mm mono jack connects to sound card input

TO EXT SPKR 3.5mm stereo jack connects to computer speaker

**FROM SOUND
CARD AUDIO OUT** 3.5mm stereo jack connects to sound card output

GROUND Ground terminal to station's ground buss (see section 5.4)

3.0 MFJ-1275T SPECIAL INSTRUCTIONS

The MFJ-1275T is a special interface unit modified for use with Ten-Tec and other radios using four-pin microphone connectors. Most four-pin connector systems use the microphone shield as a ground return for push-to-talk lines.

Use of audio shields as a control or PTT grounds causes audio systems to be much more susceptible to ground loop hum and noise, that is why most modern radios maintain separate PTT and audio ground leads. When using a common audio and PTT ground, we must be much more careful with external connections.

Please follow these basic system guidelines:

- 1.) Always ground the rear cabinet ground lug of the MFJ-1275T directly to the radio's rear- chassis ground. This will allow control signals and any undesired hum or noise to flow through the rear panel chassis ground connection and reduce hum and noise in the audio connections.
- 2.) Never make any ground connection at HD1 in the MFJ-1275T. This will force any control system grounds to use the rear panel chassis ground connections, keeping the microphone shield clear of any unwanted hum and noise.
- 3.) Always connect the computer and radio AC power cords to the same outlet or outlet strip. This will minimize voltage differences between the computer and radio chassis, reducing unwanted ground loop currents.
- 4.) Locate the MFJ-1275T near the radio. This will allow use of shorter ground connections and shorter microphone cords, reducing the resistance of the audio system shields.
- 5.) Ground the computer to the station ground buss if possible. This will ensure computer cabinets and radio cabinets are all at the same potential, and reduce unwanted hum and noise.

**Ten-Tec
and**

**KENWOOD 4-Pin Microphone Setup: TS-120S, 130S, 180S, 511S, 520S, 530, 600, 700
TS-820, 830, TR-7200A, 7400A, 7500**

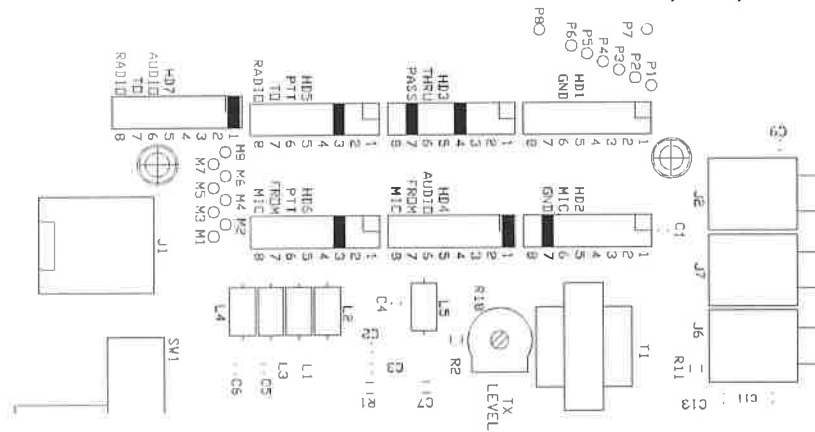

This diagram may cover some other radios in the KENWOOD product line with 4-pin round microphone jack.

If there are any Questions concerning the information provided, please refer to your RADIO NSTRUCTION MANUAL.

MFJ is neither liable nor responsible for any mistakes or errors in the information provided.

Receive Audio is taken from the External Speaker output or some other speaker level audio source.

Special Notes for Ten-Tec Radios:

When using Ten-Tec radios, avoid using the station’s 13.8-volt dc power source to power the MFJ-1275T Sound Card Interface. Always use the MFJ-1312D, or equivalent power adaptor!

4.0 MICROPHONE AND RADIO CONNECTIONS (MFJ-1275/1275M)

Different manufacturers and different radios may wire the same style connectors differently. The MFJ-1275/1275M has internal headers that use small moveable jumpers. The MFJ-1275 uses common round 8-pin microphone connectors found on most transceivers. The MFJ-1275M comes with a modular microphone jack (like telephones might use). The MFJ-1275T uses a round 4-pin for Ten Tec.

Internal jumpers are used to program connections for any radio that connects to the prewired connectors. This feature eliminates the need for soldering jacks or purchasing adapter cables. **The MFJ-1275/1275M must be configured using the internal jumpers before use** (see section 4.1 and 4.2). The MFJ-1275T comes ready to use with your Ten Tec rig.

The microphone/radio setup procedure requires a few minutes of time. Before you start, you will need the manual of your radio readily available.

4.1 INTERNAL HEADER AND JUMPER CONNECTION DESCRIPTION

This section is for the MFJ-1275 and MFJ-1275M only. The jumpers in this unit are grouped by connection type, with all eight-microphone pins in a row. The connection blocks are:

- HD1** Chassis ground
- HD2** Audio ground (*NOT* the same as *chassis* ground)
- HD3** Pass through, jumper all connections except microphone audio (HD4, HD7) and push-to-talk lines (HD5, HD6)
- HD4** Audio from microphone
- HD5** PTT line to radio
- HD6** PTT from microphone
- HD7** Microphone audio output to radio

There are eight rows of jumpers (16 pins) in each header. Each pin, starting from the rear of the unit, represents pins one through eight of the microphone connectors.

HD1- This header allows connections to *chassis ground*. **The chassis ground is normally *not* connected to any audio ground, except in the radio itself.** It is normally used only for control connections, like PTT or “up-down” button grounds.

Note: If chassis ground connects to microphone audio grounds outside the radio, low-level audio hum or distortion may appear on the transmitted signal.

HD2- This header connects to the *microphone audio* ground. The pin selected here should match the microphone *audio* ground lead. This ground is normally ***not*** connected to any chassis ground.

Note: If the audio ground connects to any chassis outside the radio, transmitter audio hum or distortion may occur.

HD3- This header provides a straight-through connection. It normally has jumpers in all positions *except* leads used by microphone “hot” audio (HD4, HD7) and push-to-talk lines (HD5, HD6). Microphone *ground* leads (PTT and audio *grounds*) should be jumpered at this header even when jumpered at HD1 or HD2.

HD4- This header is for the microphone’s hot audio output. This jumper pin should also match the radio’s “hot” audio input lead from the microphone. The pin jumpered should match the selection at HD7. This jumper pin number *should not* be connected at HD3.

HD5- This header is for the radio’s PTT (push-to-talk) lead. This jumper should match the radio’s hot PTT lead. The jumper selected here should also match the jumper selection at HD6. This pin number should not have a pass-through connection at HD3.

HD6- This header is for the microphone’s PTT (push-to-talk) input lead. The jumper should match the microphone’s “hot” PTT lead. The pin selected here should also match the selection at HD5 only.

HD7- This header is for the hot audio lead to the radio. The jumper setting should match the jumper setting at HD4 only.

4.2 JUMPER DIAGRAMS (MFJ-1275/1275M)

The Jumper Installation diagrams within this instruction manual will help you in setting up your MFJ-1275/1275M to match your radio. If your radio is not listed with the diagram, it means that we have not verified your radio to use that diagram. You can try to install jumpers as indicated. If that does not work, please refer to the radio manual to identify the MIC pin assignment for you radio then follow the instructions given in the MFJ-1275/1275M instruction manual to install the jumpers.

ICOM 8-Pin Round Microphone Setup:

IC-255, 288, 28, 290, 38A, 375, 707, 718, 725, 726, 728, 729, 730, 735, 737, 745, 746, 746PRO, 751 IC-756, 756PRO, 756PROII, 775DSP, 761, 78, 781, 910H

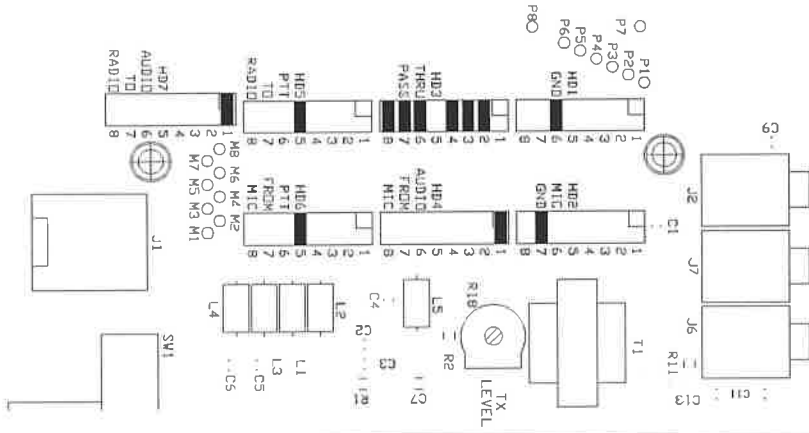

This diagram may cover some other radios in the ICOM product line with 8-pin round microphone jack.

If there are any Questions concerning the information provided, please refer to your RADIO INSTRUCTION MANUAL.

MFJ is neither liable nor responsible for any mistakes or errors in the information provided.

Receive Audio is taken from the External Speaker output or some other speaker level audio source.

ICOM 8-Pin Modular Microphone Setup:

IC-207H, 2720H, 2800H, 703, 706, 706MKII, 706MKIIG, V8000

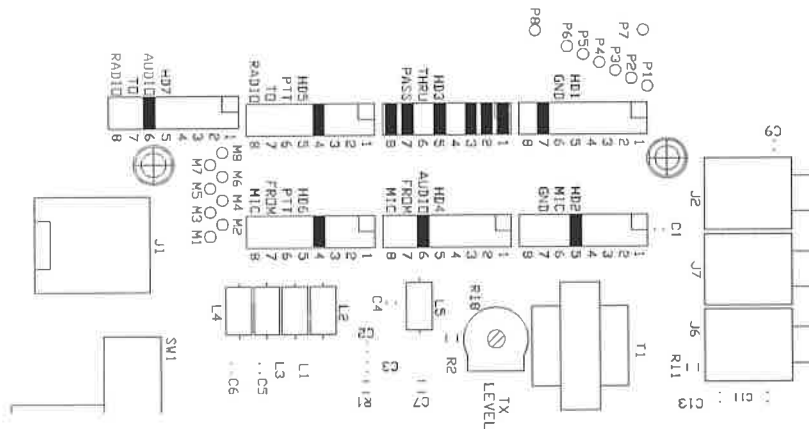

This diagram may cover some other radios in the ICOM product line with 8-pin modular microphone jack.

If there are any Questions concerning the information provided, please refer to your RADIO INSTRUCTION MANUAL.

MFJ is neither liable nor responsible for any mistakes or errors in the information provided.

Receive Audio is taken from the External Speaker output or some other speaker level audio source.

YAESU FT-650, 707, 712, 726, 736, 756, 767, 77, 790II, 700, 840, 890, 990, 1000D

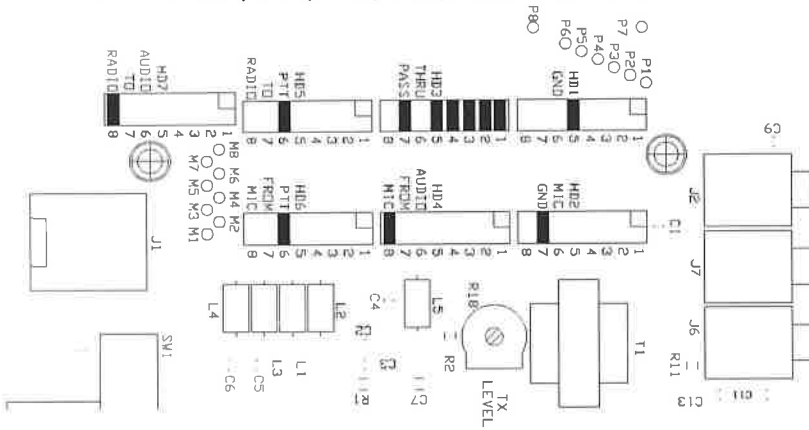

This diagram may cover some other radios in the Yaesu product line with 8-pin round microphone jack.

If there are any Questions concerning the information provided, please refer to your RADIO INSTRUCTION MANUAL.

MFJ is neither liable nor responsible for any mistakes or errors in the information provided.

Receive Audio is taken from the External Speaker output or some other speaker level audio source.

YAESU 8-Pin Modular Microphone Setup:

FT-817

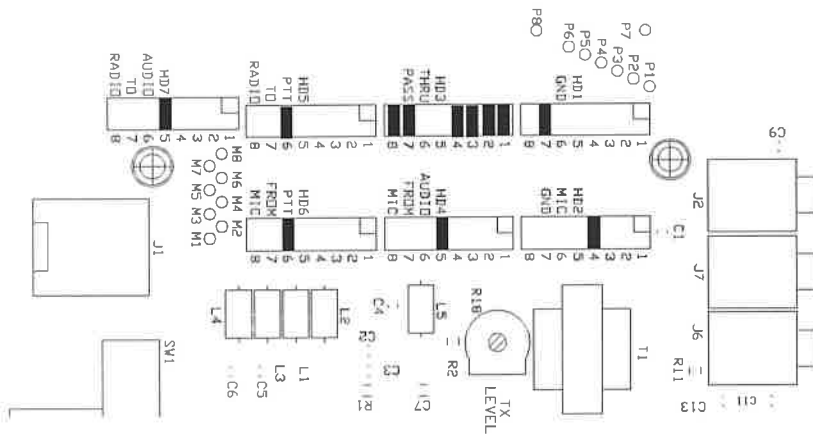

This diagram may cover some other radios in the Yaesu product line with 8-pin modular microphone jack.

If there are any Questions concerning the information provided, please refer to your RADIO INSTRUCTION MANUAL.

MFJ is neither liable nor responsible for any mistakes or errors in the information provided.

Receive Audio is taken from the External Speaker output or some other speaker level audio source.

KENWOOD 8-Pin Round Microphone Setup:

- TS-50, 60, 140, 430, 440, 450, 570, 660, 670, 680, 690, 711, 780, 811, 850, 870, 930, 940, 950
 TM-201A, 201B, 211, 221, 231, 241, 321, 331, 401A, 401B, 421, 431, 441, 521, 531, 541, 621
 TM-631, 701, 721, 731, 2530, 2550, 2570, TR-50, 751, 851, TW-4000, 4100**

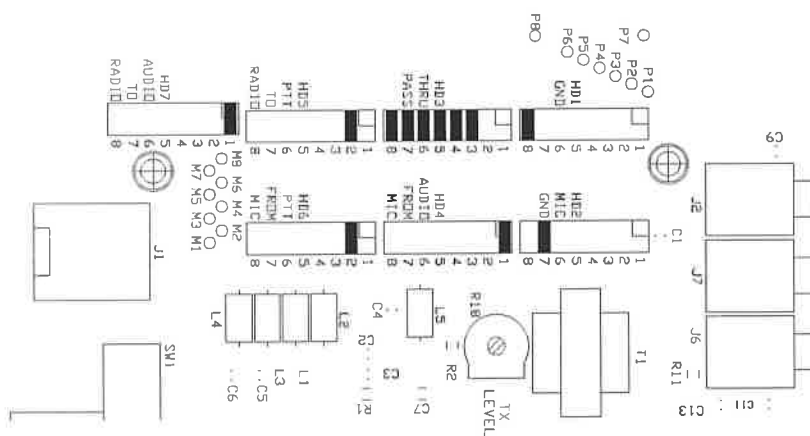

This diagram may cover some other radios in the Kenwood product line with 8-pin round microphone jack.

If there are any Questions concerning the information provided, please refer to your RADIO INSTRUCTION MANUAL.

MFJ is neither liable nor responsible for any mistakes or errors in the information provided.

Receive Audio is taken from the External Speaker output or some other speaker level audio source.

KENWOOD 8-Pin Modular Microphone Setup:

- TM-251, 255, 261, 451, 461, 641, 642, 732, 733, 741, 742, 941, 942, G707, V7A**

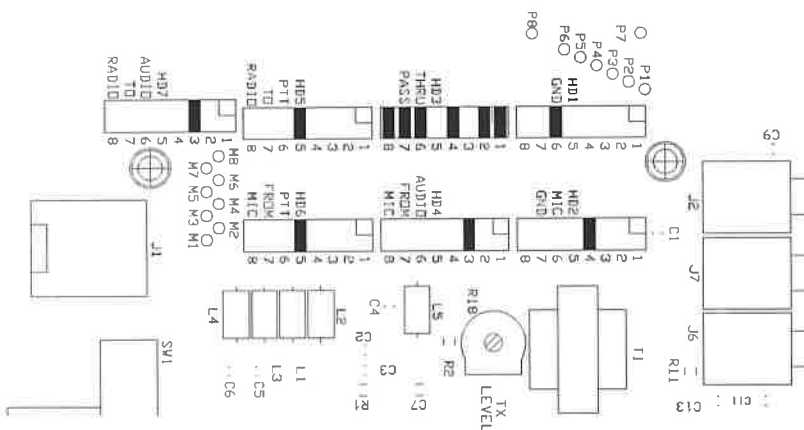

This diagram may cover some other radios in the Kenwood product line with 8-pin modular microphone jack.

If there are any Questions concerning the information provided, please refer to your RADIO INSTRUCTION MANUAL.

MFJ is neither liable nor responsible for any mistakes or errors in the information provided.

Receive Audio is taken from the External Speaker output or some other speaker level audio source.

4.3 CUSTOMIZING INTERNAL JUMPERS (MFJ-1275/1275M)

If your radio is not listed above, you can create a custom jumper position table.

Begin by removing the screws from the sides of the cabinet. Lift the cover off. Look from the front view and notice the group of pins and black jumpers on the left side behind the microphone connector and in front of the microphone output wire. Notice the pins start at the rear and are labeled 1 through 8 before repeating at the next header group.

Fill in a custom table like the following:

Table 1. Yaesu FT-1000 series

Pin	HD1 chas/ptt	HD2 mic gnd	HD3 pass	HD4 mic aud	HD5 rad ptt	HD6 mic ptt	HD7 rad aud
1			X				
2			X				
2			X				
4			X				
5	X		X				
6					X	X	
7		X	X				
8				X			X

To make a jumper table for an unlisted radio, you must look at the radio manual. Find the page that shows the microphone wiring. This is a sample of a Yaesu-style wiring diagram that was used above:

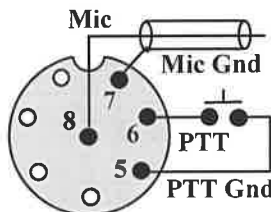

Yaesu Mic Jack Pin-out, Front View

If you compare table 1 to this connector diagram, you will see how it is laid out. Notice an “X” was placed at the appropriate PTT and MIC pins according to the rules below.

Look at the microphone-wiring diagram in your radio manual, fill in a table, and connect the leads as we have done in our example. We have provided a blank chart below for you to fill in.

- 1.) Header 4 and 7 should copy each other, and use the same jumper pin number for the center MIC wire.
- 2.) Header 5 and 6 also jointly share the same pin numbers as the PTT pin.
- 3.) The MIC GND, HD2, should connect to the same pin as the outer MIC lead and only that pin.
- 4.) The GND, HD1, should connect to the PTT ground pin.
- 5.) Be sure to place a pass-through connection jumper on every lead EXCEPT numbers used on HD 4, 7, 5, and 6.

The following blank table is for your personal use. Use your radio’s manual to complete the table. This will assist you in properly setting the jumpers for your radio.

Remember!!! Use the following wiring chart rules:

- 1.) **Never ground the microphone audio ground to the chassis ground!**
- 2.) **HD4 and HD7 are always the same jumper slot number**
- 3.) **HD5 and HD6 are always the same jumper slot number**
- 4.) **HD3 always has a jumper except where HD4 through HD7 are jumpered!**

Pin	HD1 chas/ptt	HD2 mic gnd	HD3 pass	HD4 mic aud	HD5 rad ptt	HD6 mic ptt	HD7 rad aud
1							
2							
2							
4							
5							
6							
7							
8							

4.4 AUDIO TERMINATION JUMPERS (JMP1, JMP2)

JMP1 and JMP2 are located just behind the MAN/VOX switch. JMP1 and JMP2 connect a 10-ohm load resistor across the computer sound card output to simulate a speaker load. While a load is normally not necessary, it may be needed if the sound card has excessive output level or is unstable without a load.

Remember installing these jumpers will reduce sound card level when transmitting but it may, at times, reduce distortion and noise. It will not affect any other function.

5.0 REAR PANEL CONNECTIONS

The rear panel has five audio jacks and one computer port.

5.1 COMPUTER RS-232 PORT / USB PORT

The **COMPUTER RS-232** port is a standard female DB-9 connector. It should connect to an active COM port on your computer. This connection allows the computer to watch the PTT line from your microphone, and the computer to control the transmitter PTT line. You must normally enable the COM port you use (normally COM1 or COM2) in the software you are using. Check the help menu of the program for help with COM port settings. If your computer does not have a RS-232 or if you choose to use the USB port on your computer you must purchase the optional RS-232 to USB adapter cable, MFJ-5429. Contact MFJ Enterprises, Inc. to purchase this cable.

5.2 RADIO

TO EXT SPKR: This 3.5mm monaural jack should be wired to the radio’s external speaker. This jack connects the radio’s external speaker to the radio’s speaker output when the front panel **ON/BYPASS** switch is in the “out” or **BYPASS** position. The MFJ-1275/1275M/1275T automatically disconnects the radio’s speaker when the **ON/BYPASS** switch is “in” or **ON**, and the **MONITOR** switch is not pushed. The **MONITOR/OFF** switch defeats the speaker switching, and causes the external speaker or headphone jack to remain active when the **MONITOR/OFF** switch is “in” (**MONITOR**).

FROM AUDIO OUT: This 3.5mm monaural jack should connect to your radio's external speaker output jack. It connects directly to the radio "TO EXT SPKR" jack when the ON/BYPASS switch is "out" (BYPASS) or when the MONITOR/OFF switch is "in" (MONITOR).

1. If only an *internal* radio speaker is used, you will have to plug, unplug or partially plug this connection at the radio when changing between digital and standard operation. We recommend using an *external* radio speaker to simplify changes between digital and standard operation.
2. If you wish to use a radio line-level audio output connection, you can connect the line-level output to this jack. In this case, the MONITOR/OFF switch should be placed in the MONITOR position. Otherwise, the radio may not have enough audio drive for the computer when receiving digital transmissions.

Note: Always operate the receiver at normal listening volume before switching to digital modes. Potentiometer R31 adjusts drive level from the radio receiver to the sound card. R31 is the adjustable potentiometer closest to the right side (front view) of the unit. A hole is provided in the cover so the pot can be adjusted without removing the cover. Use a very small flat-blade screwdriver and be careful to not break the potentiometer!

5.3 COMPUTER

TO SOUND CARD AUDIO IN: This 3.5mm stereo jack connects to the sound card audio-input. You can use either the sound card's microphone or the line level input. This jack connects the radio's audio output to the computer's audio input when the ON/BYPASS switch is ON.

Note: If you use the microphone input, you will want to disable any extra gain provided by the sound card. This function is normally available in the "Advanced" menu of sound card "volume control" software.

TO EXT SPKR: This 3.5mm stereo jack connects to the computer's external speaker system. This jack is automatically connected to the computer's audio output when the ON/BYPASS switch is "out" (BYPASS). It is not connected when the ON/BYPASS switch is "in" (ON), disabling the computer speakers.

FROM SOUND CARD AUDIO OUT: This 3.5mm stereo jack connects to the computer's audio output. This jack connects the computer audio output to the radio's microphone input when the ON/BYPASS switch is "in" (ON). It connects the computer to the "TO EXT SPKR" jack and the computer's speaker system when the ON/BYPASS switch is "out" (BYPASS).

5.4 GND

A ground connection post has been provided in case you have RF problems or hums. In many cases, this connection will not be needed. If you notice hum or noise on any audio lines, connect this post (with the shortest possible connection) to the ground post on your radio.

6.0 OPERATING SUGGESTION

6.1 PLACEMENT OF THIS UNIT

We recommend placing this unit as close to the radio and computer as possible. Do not place this unit within one foot of power transformers, video monitors, or anything that emits strong varying magnetic fields. If you locate this unit near a monitor, the sweep circuits can introduce hum and noise into your signal. If there is a powerline-operated transformer within several inches and if it has flux leakage, 60-cycle hum can be introduced into your stations audio systems.

6.2 HUM, SQUEALS, AND DISTORTION

When different pieces of equipment are interconnected, unwanted hum, audio distortion, or oscillations may result. RF feedback or an audio system loop of some kind may cause this condition.

To eliminate RF feedback, replace the antenna with a dummy load. If the problem still appears while transmitting at full power level, it is probably caused by a ground loop. If the problem disappears, it is almost certainly RF related. Make sure your station ground is good, and you have followed all the suggestions found in reliable sources like the ARRL Handbook.

If the problem still occurs, even while transmitting on a dummy load, be sure you have placed the microphone-wiring jumpers correctly as outlined in section 4 of this manual. Also, make sure the

microphone ground connection has continuity through the entire system, and that it is NOT connected to any other grounds or chassis except inside the radio.

Be sure you have not created a problem with improper configuration of the sound card or radio. Try turning the radio's monitor OFF when working digital, in case audio is looping from the monitor back through the sound card to the transmitter's input.

6.3 OPERATING ADJUSTMENTS

The most common problem with digital modes is an improper system level. Even at best, digital modes have limited dynamic range* compared to modes that "fit" the filters in the transmitter and receiver. This is mainly because the entire system affects bandwidth.

**Dynamic range is the ratio of strongest undesired signal tolerated to weakest signal that can be copied.*

When transmitting, it is extremely important to have levels correct. If you overdrive the input of your transceiver, your signal may interfere with others. Such problems do not always show up on spectrum or IMD displays, and if they do, many people do not recognize them. Excessive levels into the radio can aggravate harmonic distortion (this does not register on IMD readings), causing you to transmit on multiple frequencies. For example if you are on PSK using a 1,000 hertz receiving and transmitting sound card frequency, you will also have some signal level at 2,000 hertz and every other multiple of 1,000 Hz.

The system depends entirely on low distortion in the sound card and the transmitter, as well as the filter in the transmitter to limit the level of these unwanted signals.

If audio level from the sound card or interface is too low, the ratio of signal to hum and noise will be reduced.

The best way to check for proper transmission is to listen to your own signal on a separate receiver with a narrow filter, taking care to not overload the receiver. If you cannot do that, the best general guideline is to use normal microphone gain settings and approximately half volume on the sound card "Volume" settings. Adjust the transmitter level control (R18) in the MFJ-1275/1275M/1275T for normal transmitter drive (just at the start of ALC action) and use the microphone gain on the transmitter (or sound card volume) for fine adjustment. It is always a good idea to have someone listen to your signal when the band is empty, signals are strong, or noise is very low. They should look carefully for spurious signals, noise, and hum.

When transmitting on modes like MFSK and PSK, try to use a frequency setting more than 1400 Hz and less than 2200 Hz. This will allow the transmitter's SSB filter to suppress any unwanted harmonics from the audio system driving the transmitter. Use normal receiver volume setting, and adjust the sound card microphone level (make sure any extra gain options are off) to approximately half scale. Adjust the receiver level control (R31) in the MFJ-1275/1275M/1275T for normal display operation.

If you use the line output of a radio, the receiver volume control has no effect on receiving levels. Be sure you always leave the MONITOR/OFF switch in the MONITOR connector, when there is no radio speaker plugged in, or when using a radio line output connection. As an alternative, you can plug the line output of the radio directly into the computer soundcard.

Remember it is sometimes necessary to select the narrowest filter possible in the receiver, rather than depending on the computer to filter out strong unwanted stations. Many transceivers allow a selection of more narrow filters while operating SSB, or include passband-tuning controls. If you have trouble with a strong station nearby causing you to lose the desired signal, try more selectivity or use a notch filter.

6.4 MONITORING RECEIVER (SSTV, VOICE KEYER)

Certain modes, such as SSTV and Voice Keying, may require listening to receiver audio. We have provided a receive monitor switch on the front panel of the MFJ-1275/1275M/1275T.

During SSTV or Voice Keyer operations, the MONITOR switch should be set to monitor on (Push in). This will allow you to have a normal QSO and receive SSTV pictures at the same time.

In order for the MONITOR switch to work, you must have the external speaker connection of the radio connected to the MFJ-1275/1275M/1275T "Audio from Radio" connector and an external speaker connected to the MFJ-1275/1275M/1275T "Radio Speaker" connector.

Remember, when the MONITOR switch is on, the radio's external speaker will always be connected no matter what other front panel switch settings you use.

7.0 SOFTWARE

The CD included with the MFJ-1275/1275M/1275T contains a collection of shareware programs that will operate PSK-31, RTTY, SSTV, Packet, AMTOR, CW, and other modes. These programs are shareware. They are not supported by MFJ Enterprises, Inc. Some programs in the CD are feature limited, some have limited time of use and some are trial versions. Please contact the author to obtain a full version. MFJ Enterprises, Inc. offers two software packages specifically designed for sound cards. These software packages are fully supported by MFJ.

MFJ-1296 RadioCom 4 sound card program for PSK-31, RTTY, SSTV, Packet, AMTOR, and FAX/SatFAX also features DSP filter and Radio Control programs. A RS-232 radio control interface is included.

MFJ-1298 RadioCom 5 sound card program has all the features of the RadioCom 4.0 plus a DSP Audio Filter Analyzer, Spectrum Analyzer, Dual Scope Display, Sound Recorder, Audio Equalizer, Time and Frequency Management, Frequency Analyzer, 3D Scanner, Satellite Tracking, and Radio Control for over 80 receivers and transceivers. An RS-232 radio control interface is also included.

Trail versions of these programs can be downloaded. For more information about the MFJ RadioCom programs, please call MFJ Enterprises, Inc. at 1-800-647-1800 or visit us online at www.MFJEnterprises.com or www.Bonita.net.

8.0 TROUBLESHOOTING GUIDE

Sound Card Radio Interface Will Not Power Up: Check power connections and cables. Also, check the voltage and polarity of your power source--it must be capable of providing 12-15 Vdc at 100 mA.

Station Microphone PTT Function Will Not Work: Check internal microphone PTT jumpers. Read section 4 of this manual. Check to see if the jumpers match the type of transceiver you are using.

Station Microphone has no audio: Check internal microphone PTT jumpers. Read section 4 of this manual. Check to see if the jumpers match the type of transceiver and microphone you are using.

Low or Excessive Transmit Level on digital: Make sure that the *Transmit Level Control*, R18, has been set for the transmitter currently in use. Also, see if the R18 needs adjusting to bring the output level within the transceiver's limits. See section 6 for further details.

Sound Card Radio Interface Will Not Activate PTT line on Playback: Check *XMIT* switch position.

PTT Switch Fails to Halt Message Playback: Check com-port configuration and make sure that you have the software for that function.

Hum and Distortion: See section 6 and check wiring of jumpers (section 4). Also, check that the correct connections have been made with the jumpers.

Poor print or copy on good signals, distorted digital recordings: The levels from your receiver may be too high or too low. Check the potentiometer, R31, to insure that it is adjusted correctly (see section 5.2). Also, look to see if the card settings are configured correctly (see section 6). Lastly, check to see if the switches are in the correct position.

9.0 TECHNICAL ASSISTANCE

If you have any problem with this unit first check the appropriate section of this manual. If the manual does not reference your problem or your problem is not solved by reading the manual, you may call *MFJ Technical Service* at **662-323-0549** or the *MFJ Factory* at **662-323-5869**. You will be best helped if you have your unit, manual and all information on your station handy so you can answer any questions the technicians may ask.

You can also send questions by mail to MFJ Enterprises, Inc., 300 Industrial Park Road, Starkville, MS 39759; by Facsimile (FAX) to 662-323-6551; or by email to techinfo@mfjenterprises.com. Send a complete description of your problem, an explanation of exactly how you are using your unit, and a complete description of your station.

10.0 SCHEMATIC

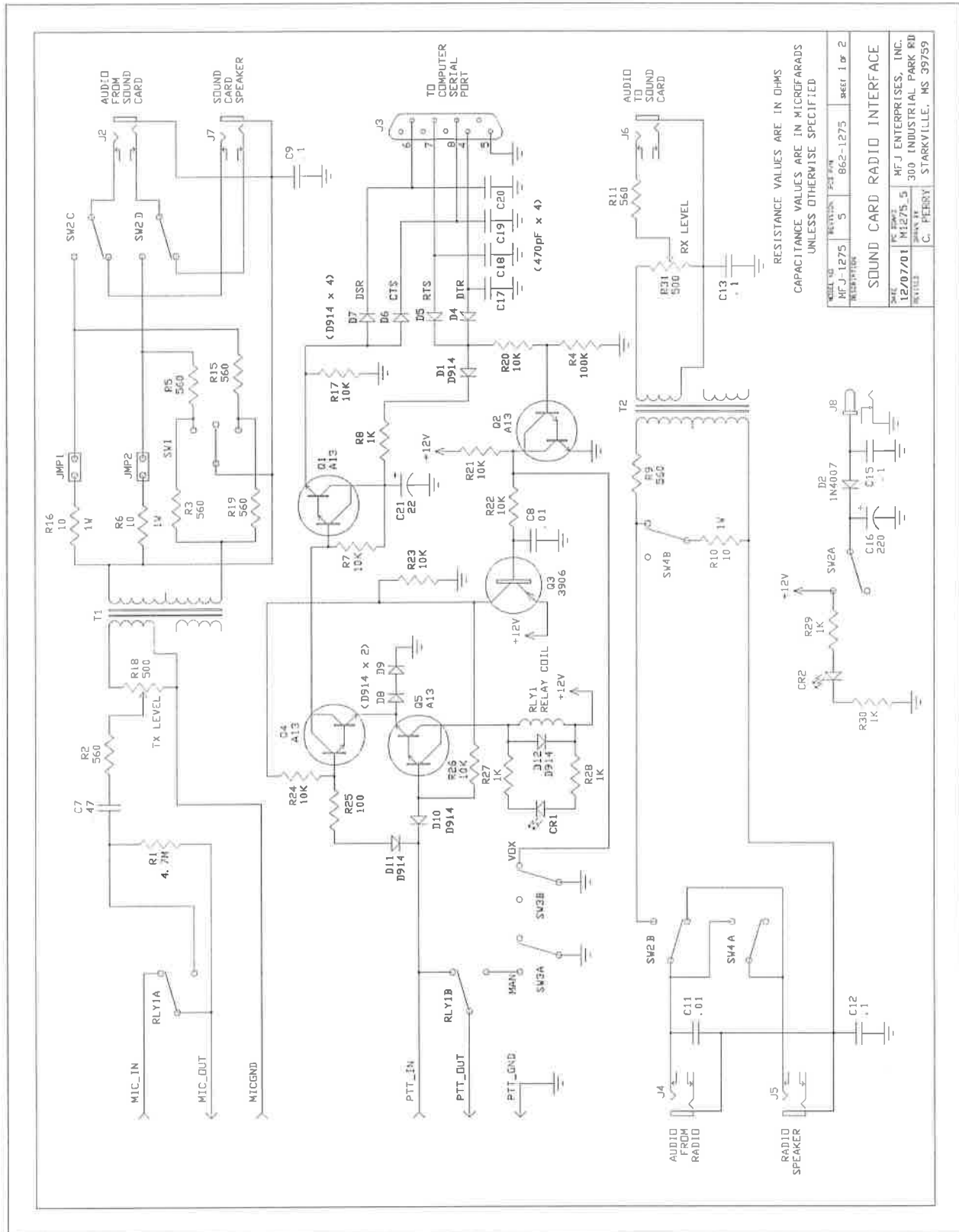

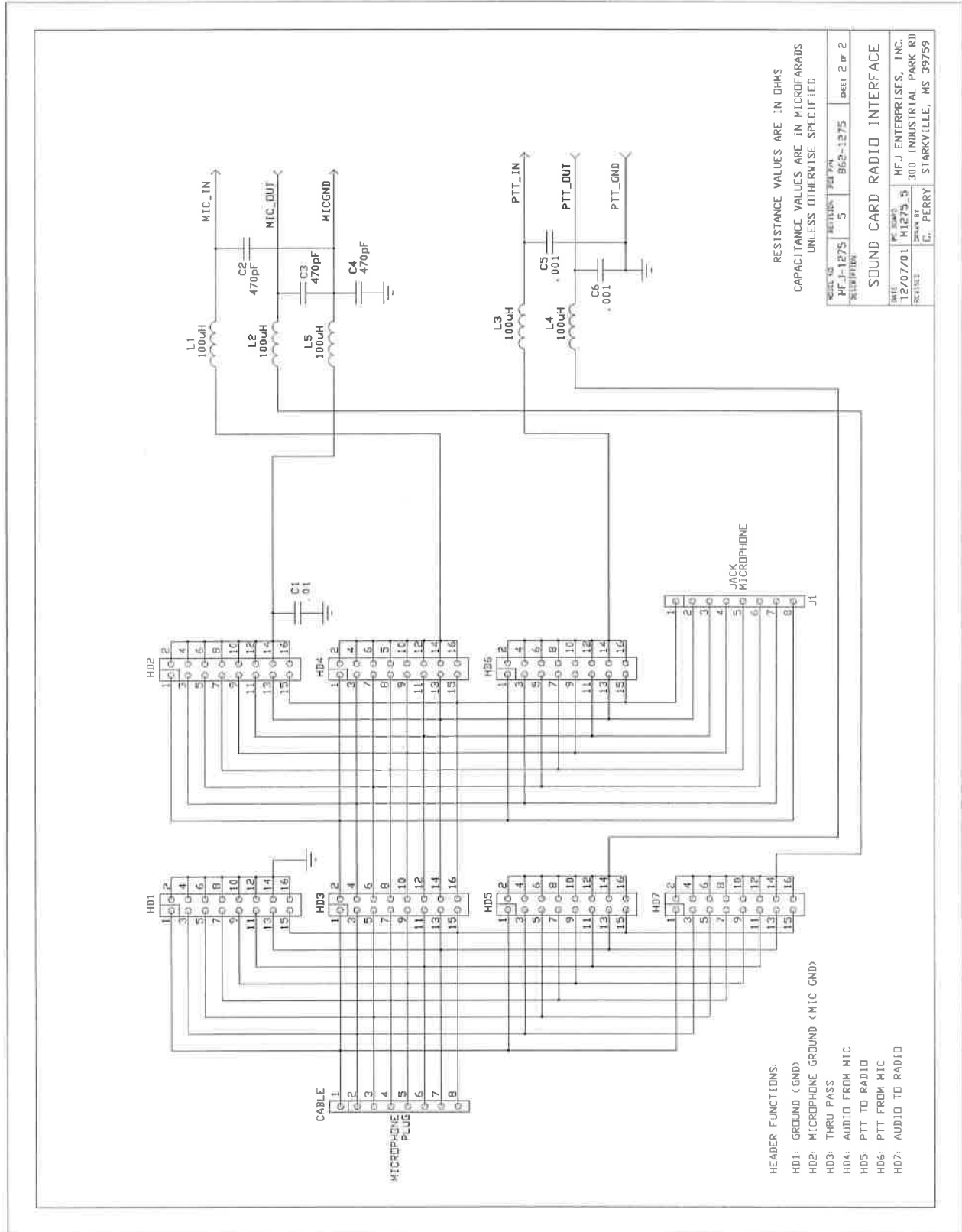

RESISTANCE VALUES ARE IN OHMS
 CAPACITANCE VALUES ARE IN MICROFARADS
 UNLESS OTHERWISE SPECIFIED

DATE	REV	DESCRIPTION	DESIGNED BY	DATE	SHEET
12/07/01	1	MFJ-1275	C. PERRY	06/2-1275	2 OF 2

MFJ ENTERPRISES, INC.
 300 INDUSTRIAL PARK RD
 STARKVILLE, MS 39759

LIMITED 12 MONTH WARRANTY

MFJ Enterprises, Inc. warrants to the original owner of this product, if manufactured by MFJ Enterprises, Inc. and purchased from an authorized dealer or directly from MFJ Enterprises, Inc. to be free from defects in material and workmanship for a period of 12 months from date of purchase provided the following terms of this warranty are satisfied.

1. The purchaser must retain the dated proof-of-purchase (bill of sale, canceled check, credit card or money order receipt, etc.) describing the product to establish the validity of the warranty claim and submit the original or machine reproduction of such proof of purchase to MFJ Enterprises, Inc. at the time of warranty service. MFJ Enterprises, Inc. shall have the discretion to deny warranty without dated proof-of-purchase. Any evidence of alteration, erasure, or forgery shall be cause to void any and all warranty terms immediately.
2. MFJ Enterprises, Inc. agrees to repair or replace at MFJ's option without charge to the original owner any defective product under warranty provided the product is returned postage prepaid to MFJ Enterprises, Inc. with a personal check, cashiers check, or money order for \$7.00 covering postage and handling.
3. This warranty is **NOT** void for owners who attempt to repair defective units. Technical consultation is available by calling the Service Department at 662-323-0549 or the MFJ Factory at 662-323-5869.
4. This warranty does not apply to kits sold by or manufactured by MFJ Enterprises, Inc.
5. Wired and tested PC board products are covered by this warranty provided **only the wired and tested PC board product is returned**. Wired and tested PC boards installed in the owner's cabinet or connected to switches, jacks, or cables, etc. sent to MFJ Enterprises, Inc. will be returned at the owner's expense unrepaired.
6. Under no circumstances is MFJ Enterprises, Inc. liable for consequential damages to person or property by the use of any MFJ products.
7. **Out-of-Warranty Service:** MFJ Enterprises, Inc. will repair any out-of-warranty product provided the unit is shipped prepaid. All repaired units will be shipped COD to the owner. Repair charges will be added to the COD fee unless other arrangements are made.
8. This warranty is given in lieu of any other warranty expressed or implied.
9. MFJ Enterprises, Inc. reserves the right to make changes or improvements in design or manufacture without incurring any obligation to install such changes upon any of the products previously manufactured.
10. All MFJ products to be serviced in-warranty or out-of-warranty should be addressed to:

**MFJ Enterprises, Inc.,
300 Industrial Park Road
Starkville, Mississippi 39759 USA**

and must be accompanied by a letter describing the problem in detail along with a copy of your dated proof-of-purchase.

11. This warranty gives you specific rights, and you may also have other rights which vary from state to state.

All-in-One Multimode Sound Card Program

PSK31, SSTV, FAX, RTTY, SITOR, CW Sound Card Software . . . DSP Filter and Analyzer for receive audio . . . Rig control over 80 radios with RS-232 level converter . . . free demo version at: <http://www.mfjenterprises.com>

• Supports PSK31! • RadioCom4, \$129.95 • RadioCom5, \$199.95

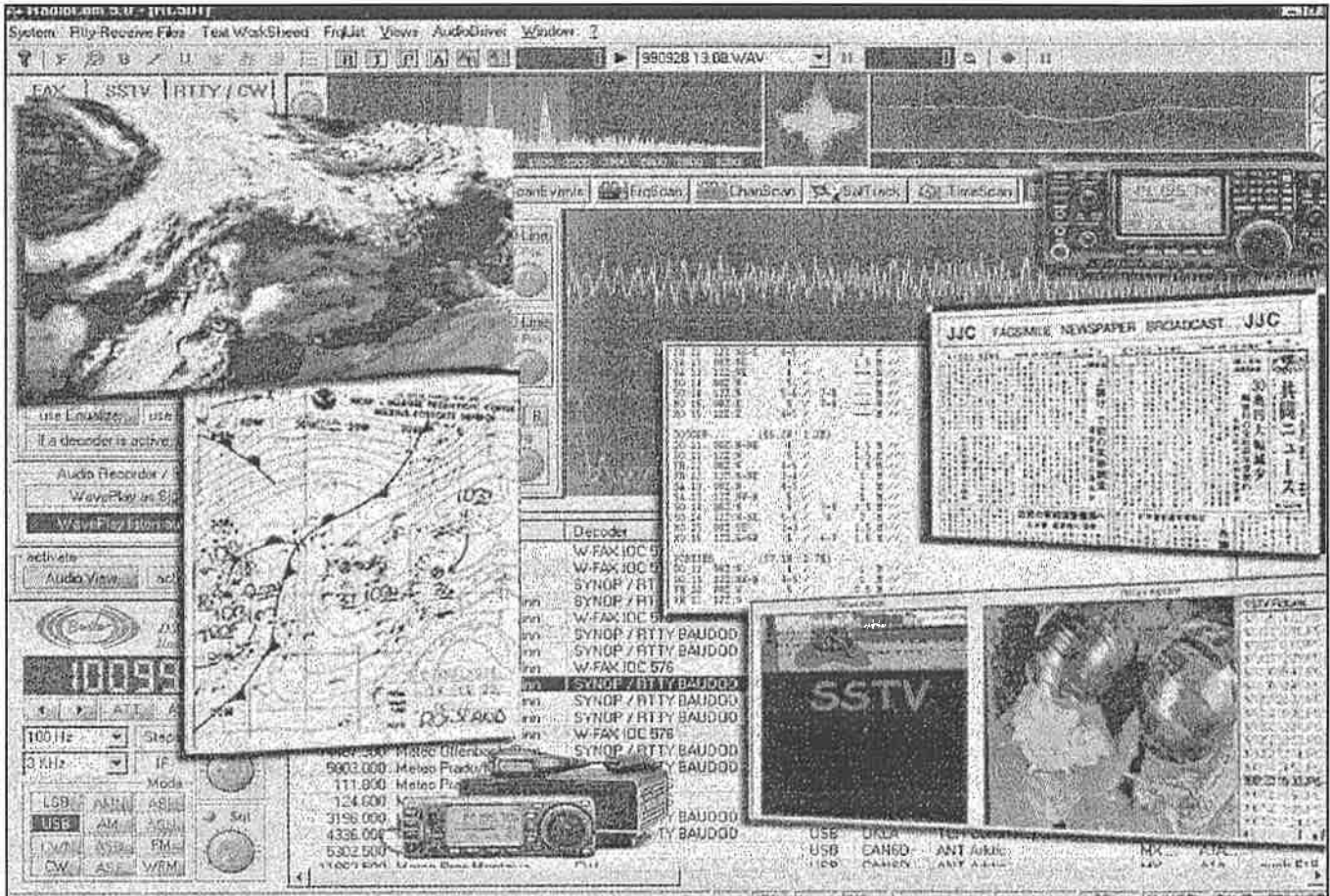

MFJ presents the first program of its kind written for sound card interfaces and amateur radio. This fully integrated software program is fully supported by MFJ.

What does this program do?

It decodes digital and analog signals from the radio. It also improves the quality of sound, what was in the past only done by an expensive DSP-Receiver. The signal goes direct into your computer over the soundcard for processing, you can then also control your radio over the COM-port and all this without any extra hardware. The received signals are filtered and then given out to the computer speakers.

PSK: Supports PSK-31, Q and

B PSK.

SSTV: 32-bit color, supports all SSTV formats, screen sizes/SSTV parameters are all variable.

FAX: Supports AM/FM. Includes Weather FAX and satellite FAX direct. Supports ICO 267, 288, 352 and 576. RPM 48, 60, 90, 120, 180 and 240. Fax resolution is up to 1810 dpi. FAX features IOC and slant-correction, FAX pictures can be saved, printed or retransmitted.

CW: Features automatic speed tracking, DSP notch and band-pass filters.

RTTY: Supports all standard shifts and speeds. X/Y scope and frequency spectrum display makes tuning RTTY a breeze. Also supports NAVTEX, European

SYNOP, Baudot, Sitor-B.

MFJ RadioCom requires Pentium/Celeron processor with at least 200 MHz, 64 MB RAM with sound card. Use Win95/98/ME/2000/NT. MFJ-1296, \$129.95.

RadioCom4 features PSK31, SSTV, FAX/Sat FAX, RTTY, SITOR, DSP audio filters and radio control. MFJ-1298, \$199.95. RadioCom5 has all features of RadioCom4 plus DSP Audio Filter Analyzer, Spectrum Analyzer, Dual Scope Display, Sound Recorder, Time/Frequency Management, Frequency Analyzer, 3D Scanner, Satellite Tracking, and Radio Control for over 80 radios and much, much more!