

Table of Contents

Features.....	1
Technical Specifications (Typical Unit):	3
Receiver:	3
Transmitter:	3
Simplified Technical Description:	4
MFJ-8621A Technical Description:	4
General:	4
Receiver:	4
Transmitter:	4
T/R Switching:	4
TNC Data Carrier Detect Compatibility	4
Connecting To Your MFJ-8621A:.....	6
Power Supply:	6
Antenna:.....	7
TNC Connection:.....	7
Computer Connections:.....	7
RFI:	8
Selecting Baud Rate:	9
Receiver Filter:	9
Transmitting:	9
Transmitter Deviation:.....	10
Setting Deviation:	10
Sound Card Operations:.....	10
Two-Way Deviation Monitoring:	11
Confirming Deviation:	12
Ordering Crystals:	13
Receiver Crystal:	13
Transmitter Crystal:.....	13
Installing Crystals:.....	14
Crystal Oscillator Calibration:.....	15
Transmit Oscillator:	15
Receiver Oscillator:	15
More About 9600-Baud FSK Packet Signals:	16
Sending And Receiving 9600-Baud Data:.....	16
In Case Of Difficulty:	18
1. Unable To Copy Off-Air Signals:	18
2. Unable To Connect:	18
3. Transmitter Erratic Or Inoperative:	18
Important Operator Notes:	18
Appendix.....	20
Technical Assistance.....	20
Replacing The Fuse Link.....	20

MFJ-8621A 2-Meter Packet Only™ Data Radio

Congratulations on your choice of the MFJ-8621A Packet Only Data Radio. Please read this manual thoroughly before attempting to operate your unit. Let's begin with a look at some useful MFJ-8621A Features:

FEATURES

Packet-Only Performance: The MFJ-8621A is designed from the ground up for packet. This means you'll get uncompromising performance at all data rates--on AFSK or FSK--for a fraction of what you'd pay for a converted voice radio.

Cool Running: The MFJ-8621A draws only 25 mA on receive, and less than 1 A on transmit. Run it 24 hours a day 365 days a year, or pack it with your lap-top and take it on the road.

Sensitive: Motorola-IC based receiver circuitry recovers data from weak signals for better throughput and fewer collisions.

Made-For-Data Filters: Optimize your receiver for wide 9600-baud signals or narrow 1200-baud signals. No other radio does this!

Rugged 5-Watt Transmitter: All the power you need to get the job done without creating needless interference at distant nodes.

Clean Unsquelled Data Output: The MFJ-8621A uses a wide-response DC-coupled line driver rather than a speaker amp for flawless signal recovery.

Note: Your TNC must have full DCD (Data Carrier Detect) in order to work with radios that have full unquelled AFSK output.

Lightning-Fast TXD: Set TXD low! PIN-diode switching, continuous-running receiver, and crystal control deliver ultra-fast switching.

Twin Modulators: Varactor-modulation for true-FM at 9600-baud and reactance modulation for mic-level signals at 1200 baud provide ultra-clean FSK and AFSK.

Simple Setup: The MFJ-8621A is compatible with virtually all up-to-date TNC-2 modems.

Easy To Rechannel: Run your MFJ-8621A with supplied crystals on 145.01 MHz, or order custom crystals for the channel of your choice. Simple step-by-step instructions illustrate how to exchange crystals and set on frequency without expensive test equipment.

Audio Input and Output Jacks: The newly designed MFJ-8621A now has Audio Input and Output Jack to feed directly to your Computer Sound Card. Enjoy the

benefits of using your computer's sound card and get on line with any number of the available Sound Card Packet and APRS programs.

RS-232 Jack for PTT Keying: The RS-232 port has selectable lines for keying your MFJ-8621A. Running Dual Sound Card TNC's. No problem with the MFJ-8621A.

The Right Tool For The Job: Your MFJ-8621A was designed from scratch for fast, clean packet communication and nothing else! Whether you are monitoring the local DX cluster or breaking new ground at 9600, you can look forward to years of hands-off service.

TECHNICAL SPECIFICATIONS (Typical Unit):

Receiver:

Frequency Coverage..... 144-148 MHz
 Sensitivity..... 0.6 μ V for 12 dB Quieting
 Image Rejection..... -45 dB or better
 1st IF..... 10.7 MHz
 2nd IF..... 455 KHz
 1st LO..... Crystal , 3rd overtone
 2nd LO..... 10.245 MHz
 Selectivity..... -6 dB at 20 KHz (data-passband filter)
 AFSK Output..... Unsquelled, 0dBm @ 3.0-KHz deviation
 Current Drain..... 25 mA

Transmitter:

Frequency Control..... Crystal, 18-MHz x 8
 FSK/AFSK Input level..... 150 mV p-p @ 1200 baud, .8 V p-p @ 9600
 Deviation..... 0-5 KHz, adjustable at TNC
 RF Power Output..... 4.0 - 5.0 Watts into 50 Ohms
 VSWR Tolerance..... 3:1 Max.
 Current Drain..... 1.0 Amp @ 13.8 Volts

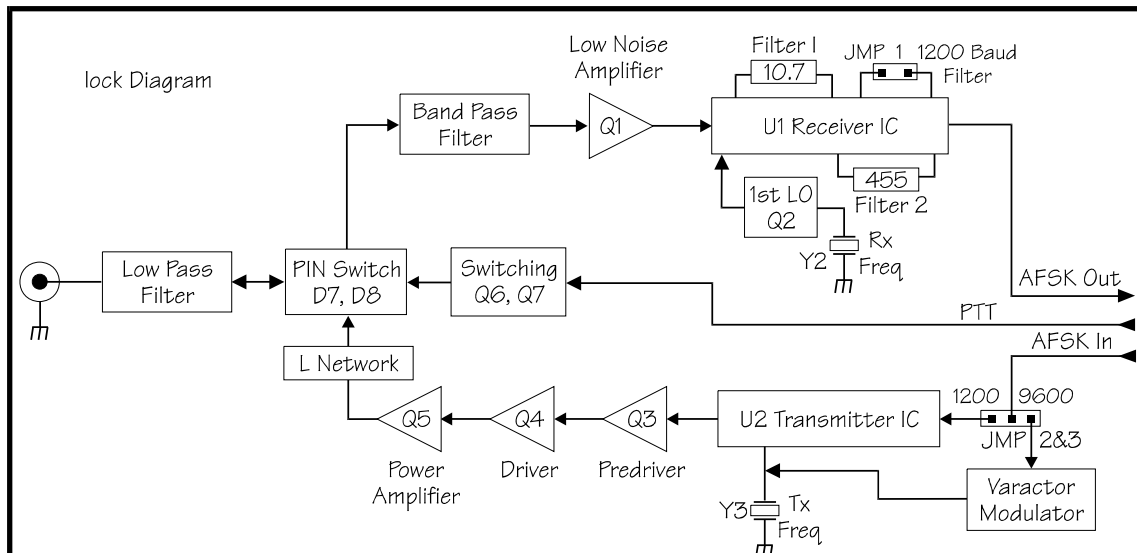

Figure 1 Block Diagram of MFJ-8621A Data Transceiver

SIMPLIFIED TECHNICAL DESCRIPTION:

Your MFJ-8621A was especially designed for packet-only operation. MFJ has eliminated costly circuitry that you don't need: such as squelch, repeater offsets, PL tones, DTMF pad, PLL synthesis, memory, and the speaker-amplifier. At the same time, we engineered in essential packet circuits like true-FM direct modulation, unsquelched AFSK, PIN-diode switching, data-passband IF filtering, and a tailored 0-Vu DC-coupled line driver to ensure top-notch performance. For use with a TNC there are no user-adjustable controls to set incorrectly, and the MFJ-8621A works with most popular TNCs. For Sound Card use there is only one Audio Level adjustment that will normally work with no adjustment

MFJ-8621A TECHNICAL DESCRIPTION:**General:**

The MFJ-8621A is a dedicated-channel 2-Meter FM-AFSK transceiver designed for use with ***DCD equipped*** TNC-2 style modems at data-rates through 9600 baud.

Receiver:

Referring to Figure 1, incoming signals are preselected by the lowpass and bandpass filters. Low-noise preamp Q1 enhances weak signal performance. U1 is a monolithic dual-conversion narrowband-FM receiver IC that provides all mixer, IF amplification, limiting, and audio functions. The 1st-LO, Q2, is an external 3rd-overtone oscillator-tripler and the 2nd LO is built into U1. U1 and Q2 remain powered during transmit to ensure seamless RX recovery and self-monitoring capability. IF passband filtering is provided by ceramic filters FL1 (10.7 MHz) and FL2 (455 KHz). FL2 is a 20-KHz data-bandwidth filter which supports 9600 baud operation. Discriminator output is looped to U1's auxiliary op-amp which is configured as a DC-coupled AFSK line driver. Gain is set to provide 0-dBm AFSK output into a 600-Ohm load for approximately 3.0 KHz deviation. A jumper configures the line driver feedback loop for HF noise reduction at 1200 baud AFSK reception. Test points at the 1st-LO, RSSI, and DISC outputs facilitate alignment.

Transmitter:

FM signals are generated by monolithic FM-transmitter IC U2. Frequency control is provided by 18-MHz crystal Y3 (oscillator/modulator output is multiplied by three successive doubler stages to 145 MHz). 1200-baud AFSK is fed directly to the IC's reactance modulator. 9600-baud FSK is fed through a varactor modulator for true-FM modulation. Pre-driver Q3 and Driver Q4 operate in class AB and use tuned bifilar 4:1 interstage transformers to facilitate matching and bandpass filtering. The PA stage (Q5) is a conventional class-C amplifier with a tuned-L network and pi-section low-pass filter to provide Z-matching and harmonic suppression.

T/R Switching:

RF switching is executed by PIN diodes D8 (receive path) and D7 (transmit path). DC switching is executed by Q6, Q7. When used with a Computer switch is accomplished using an Opto-Isolator for RFI immunity from computer generated noise. Supply voltage to U1 is regulated at 5 volts, and voltage to U2 is regulated at 8 Volts. The 1st-LO voltage is regulated at 6.8 Volts. Receiver chip U1 remains powered during transmit for seamless T/R switching characteristic. The MFJ-8621A is designed to operate at 13.8-Volts @ 1-Amp.

TNC DATA CARRIER DETECT COMPATIBILITY

As a "packet-only" radio, the MFJ-8621A is specially designed to transmit and receive all data rates through 9600 baud. However, to accomplish this, the MFJ-8621A must deliver *unsquelched* AFSK or FSK data to the TNC. The MFJ-8621A does not provide squelched AFSK because conventional squelch circuits are far too slow to be useful above 1200 baud. In order to process unsquelched data from the MFJ-8621A (or any high speed data radio), your TNC must have a data carrier detect (DCD) circuit built in. All MFJ model TNCs -- starting with the MFJ-1270B-- and virtually any other TNC that operates over 1200 baud should have one as well (PK-96, DPK-9600 for example).

Unfortunately, many TNCs, like the PK-232 and even some low cost mini-TNCs, lack DCD because they are made exclusively for use with conventional FM voice radios to run at 1200 baud. If your TNC does not have DCD, it cannot distinguish between limiter noise (the strong rushing noise FM radios produce with no signal present) and data signals. Since the TNC sees the limiter noise as incoming signal, it will not allow the TNC to transmit due to the TNC's data collision protection function. Consequently, the radio will appear incapable of transmitting! Again, your TNC *must* have DCD to work with the MFJ-8621A.

If your TNC *does* have a DCD, make sure the function is enabled in your particular unit. Read your TNC documentation carefully to confirm what type of carrier detection--if any--exists in your unit. If you *do* have DCD, activate it.

Important Note:

Some TNC's have software DCD circuits that may also require internal adjustments (check your TNC manual and follow activation instructions carefully). Other TNCs may not have a DCD at all or have a DCD indicator that is really nothing more than a mis-labeled "signal-present" indicator. Separate "universal" add-on DCD circuits are available for TNCs that lack a DCD. PacComm offers add-on DCD circuits for many applications and has information about choosing the right DCD to fit your needs.

Refer to the appendix for notes on specific TNCs.

CONNECTING TO YOUR MFJ-8621A:

Power Supply:

The MFJ-8621A will operate from any well-filtered DC power source delivering 13.8 Volts at 1 Amp. The MFJ-4110 wall-adaptor supply is a light-weight voltage-regulated unit especially suited for powering the MFJ-8621A. "CB" type supplies or battery packs capable of 1-A output will also work (anticipate lower RF output when using a 12-volt source). The MFJ-8621A accepts a standard 5.5mm x 2.1mm coaxial-type power plug (Radio Shack 274-1569). Connect the (+) or red lead to the center pin, and connect the (-) or black lead to the outer sleeve. Use a 2 amp fast-blow fuse with any power supply other than the MFJ-4110. Your MFJ-8621A features "crowbar" protection to prevent damage from incorrect power supply polarity. If power leads are accidentally reversed, the crowbar-diode conducts and immediately opens the radio's line fuse, cutting off power (for line-fuse replacement instructions, see the Appendix).

Antenna:

For best packet performance, use a high-quality antenna adjusted for minimum VSWR at your operating frequency. Omni-directional types--like the MFJ-1740 1/4-wave ground plane, MFJ-1750 5/8-wave ground plane, or MFJ-1764 dual 5/8-wave Super gain™--should provide excellent area coverage. If you need added punch to gain reliable access into a busy regional node, install a directional antenna--like the MFJ-1763 3-element 2-Meter beam. When installing the antenna, be sure to feed it with high-quality low-loss coax and keep the cable run as short as possible. In many cases, a lower antenna fed with good cable will outperform a higher antenna fed with lossy cable. To cut line losses to a minimum, avoid adding unnecessary in-line connectors, power meters, and coax switches.

TNC Connection:

The MFJ-8621A plugs directly into any MFJ TNC starting with the MFJ-1270B. Any other DCD equipped TNC, such as the PK-96 and many others, will also work with this data radio. Use a 5-pin DIN-to-5-pin DIN cable, MFJ-5100, for connection to MFJ TNCs or the PK-96.

Caution: *Not All TNCs have DCD (Data Carrier Detect) circuitry, and your MFJ-8621A --which has an unsquelched output--will not work with those TNCs.*

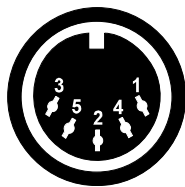

Pin	Function
1	AFSK IN (150 mV pp / 800 mV pp)
2	GND
3	PTT (ground or logic-low for TX activation)
4	AFSK OUT (2.2 V pp into 600 Ohms)
5	N.C.

Computer Connections:

Refer to the rear of the MFJ-8621A for connecting to your Computer. A single 9-Pin serial cable and a pair of 3.5 mm to 3.5mm stereo cables are all that are required.

RFI:

After completing initial adjustments, always reinstall the covers on your MFJ-8621A and TNC. Without shielding, the receiver may be swamped with RF interference generated by microprocessors in the computer and TNC. For added RFI protection, many veteran packet operators recommend installing ferrite RFI chokes on interconnect and power cables--and keeping the radio as far as possible from the TNC and computer. The MFJ-701 RFI kit provides 4 snap-on chokes for this purpose, along with instructions. Snap-on RFI chokes are also available at Radio Shack (273-104 and 273-105).

SELECTING BAUD RATE:**Receiver Filter:**

The MFJ-8621A receiver features a special noise-reduction filter to enhance 1200-baud operation. When running at 1200-baud, this filter improves weak-signal performance. To activate the 1200-baud noise-reduction filter, install a shorting plug at JMP-1 (this plug must always be removed when operating at 9600-baud).

See Figure 2 below for placement of the jumpers on the pc board.

Transmitting:

The MFJ-8621A has two FM modulators selected by jumpers, JMP2 and JMP3. One is a sensitive **reactance modulator** designed for **mic-level** AFSK signals. Since most TNC's output mic-level signals at 1200 baud, the reactance modulator should be used at 1200 baud. The other is a "true-FM" **varactor modulator** designed for **line-level** FSK signals. At 9600 baud, most TNC's have a line-level output and should be used with the varactor modulator. If your TNC has a line-level output setting for 1200 baud TX-AFSK (usually set via a jumper inside the TNC), you may use the varactor modulator at both data rates.

For 1200-baud AFSK operation, install JMP1 and set JMP-2 and JMP-3 in the reactance modulator positions (left-hand and center pins of each header).

For 9600-baud FSK operation, remove JMP1 and set JMP-2 and JMP-3 in the varactor modulator positions (center and right-hand pins of the headers).

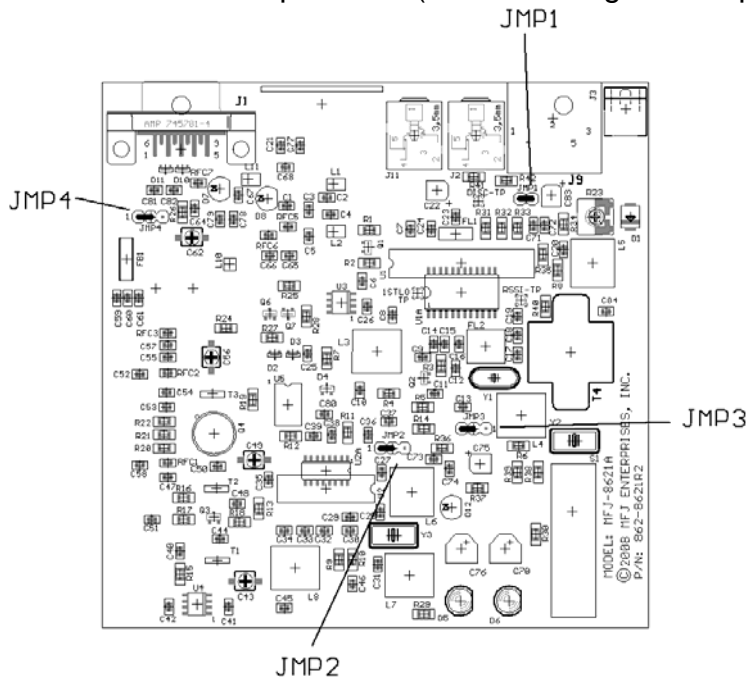

Figure 2

IMPORTANT NOTE: *JMP1, JMP2 and JMP3 are set for 1200 baud at the factory. Always recalibrate the MFJ-8621A transmitter oscillator for frequency (L6) after switching modulators (see calibration, page 15).*

TRANSMITTER DEVIATION:

Setting Deviation:

The MFJ-8621A has no internal deviation control. Deviation is adjusted via the AFSK output level control on your TNC (consult your TNC manual for specifics). If you don't have access to a FM deviation meter, you can set deviation by measuring the peak-to-peak AFSK signal output from your TNC:

With jumpers in the **reactance modulator** (1200-baud) jumper positions, a **150-mV** p-p sine wave should produce approximately 3-KHz deviation. With jumpers in the **varactor modulator** (9600-baud) jumper positions, a **800-mV** p-p sine wave should produce approximately 3-KHz deviation.

Virtually any calibrated oscilloscope will allow you to make this measurement. Connect your scope probe to PIN-1 on the 5-pin DIN jack at either the TNC or radio end (look for the TX-AFSK line if your TNC uses a different type of jack). Use the CALIBRATE function on your TNC to generate a test-tone.

SOUND CARD OPERATIONS: Connect the MFJ-8621A to you Computer Sound card Input and Output using 3.5mm Stereo Cables.. The PTT line from the Computer on the RS-232 serial port is factory defaulted to the RTS line Pin 7 of the serial port. To use with the DTR line Pin 4 of the serial port simply move the jumper on JMP4 shown in Figure 2 on page 9 to the right position.

Use your audio input and output levels of your computer to adjust the levels to an appropriate level using the tune function of your program. If unable to adjust the deviation either high enough or low enough from the level coming from your computer then adjust R23 shown in Figure 4 on page 14. Normally this is unnecessary.

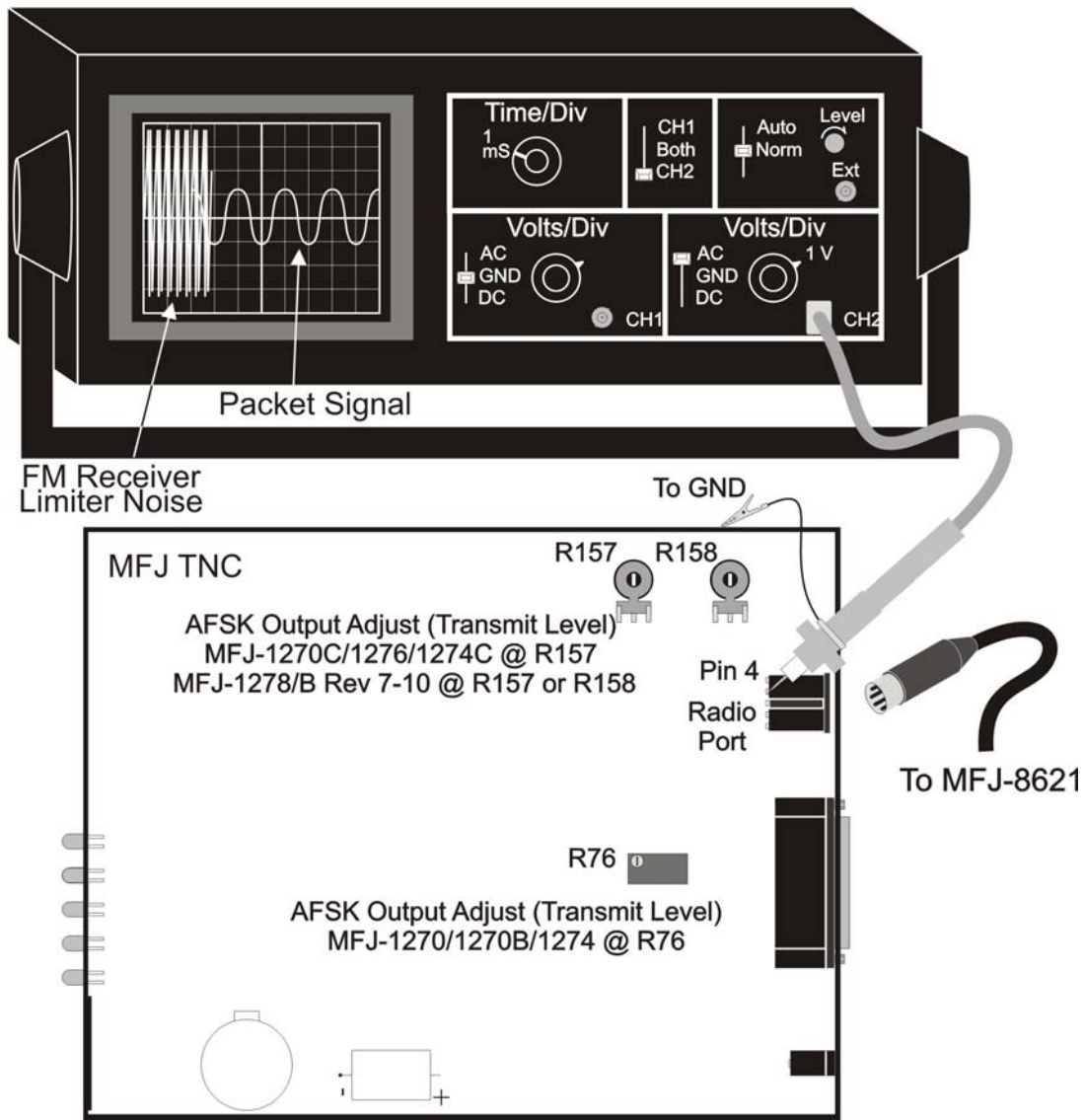

Figure 3 monitoring Incoming and Outgoing Signals with a Scope

Two-Way Deviation Monitoring:

In addition to monitoring TNC output at pin 5, you may also monitor both incoming and outgoing Packet signals passing through your station by connecting an oscilloscope to the RX-AFSK line at pin-4. RX-AFSK also appears at the "monitor" or "speaker" jack on most TNCs. Use 1-V/div V-sens and 1-ms/div H-time base. To set TX deviation while monitoring RX-AFSK, first note the waveform height of average off-air signals (2.2 V p-p is typical for 3-KHz deviation). Next, key the MFJ-8621A transmitter via the CALIBRATE function on your TNC--and adjust TNC output (TX-AFSK) for a waveform of about the same height.

Confirming Deviation:

If a node in your area uses the X-1J2 version of theNET, you can take advantage of that station's built-in deviation meter to confirm the accuracy of your setting. Anytime you experience consistent difficulty connecting with local stations, you should suspect improper deviation level as a possible cause.

ORDERING CRYSTALS:

You may order crystals for other channels factory-direct. Crystal specifications are:

Receiver Crystal:

$$\text{XTAL Freq} = \frac{\text{Operating Freq} - 10.7 \text{ MHz}}{3}$$

TYPE.....	3rd overtone (44-MHz range)
TOLERANCE.....	.003% Commercial Standard
TEMPERATURE.....	26-Degrees C (room temperature)
LOAD.....	Series
CASE.....	HC-25U or FM-2

Transmitter Crystal:

$$\text{XTAL Freq} = \frac{\text{Operating Freq}}{8}$$

TYPE.....	Fundamental Mode (18-MHz range)
TOLERANCE.....	.003% Commercial Standard
TEMPERATURE.....	26-Degrees C (room temperature)
LOAD.....	32 pF, Parallel
CASE.....	HC-25U or FM-2

Crystals for the MFJ-8621A may be ordered directly from:

JAN Crystals

P.O. Box 06017, 2341 Crystal Drive
 Fort Myers, FL 33906-6017
 Telephone (800) 526-9825, FAX (813) 936-3750

When ordering from JAN, simply tell the sales person that you wish to order a pair of crystals for the MFJ-8621A Data Radio and give the **operating frequency** in MHz. JAN has complete MFJ-8621A crystal specifications on file in their ordering system and no additional information is required. Alternatively, you may purchase crystals from:

International Crystal Manufacturing Co., Inc. (ICM)

10 North Lee Avenue
 Oklahoma City, OK 73102
 Telephone: (800) 725-1426, FAX (800) 322-9426

For receiver crystals, order 725701-OPERATING FREQ
 For transmitter crystals, order 725702-OPERATING FREQ
 JAN and ICM both welcome telephone orders and accept MasterCard or Visa.

INSTALLING CRYSTALS:

To install new crystals in your MFJ-8621A, refer to the diagram below:

- [] Remove the MFJ-8621A cabinet lid (one screw on each side of the cabinet).
- [] Locate and pull the existing transmit crystal (Y3) from its socket.
- [] Carefully plug the new transmit crystal in its place.
- [] Locate and pull the existing receive crystal (Y2) from its socket.
- [] Carefully plug the new receive crystal in its place.

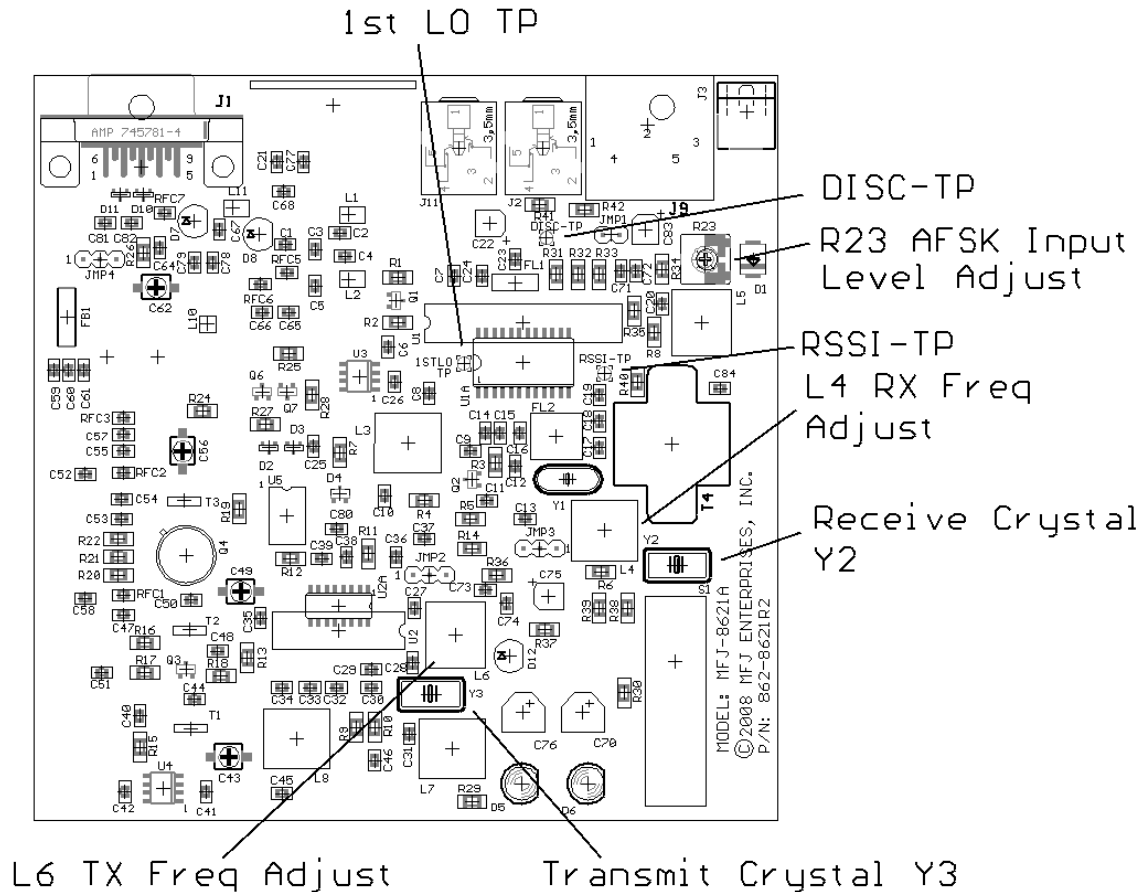

Figure 4 Crystal Locations and Calibration Adjustment Points.

For future reference, label your pull-out crystals for operating frequency and store them in a safe place.

Anytime you install new crystals, you must readjust L4 and L6 for exact frequency calibration on the new channel (see page 15). Do not attempt to operate your radio until this calibration procedure has been completed.

CRYSTAL OSCILLATOR CALIBRATION:**Transmit Oscillator:**

To measure the exact operating frequency of the MFJ-8621A transmitter, monitor the radio's RF output signal with a digital frequency counter. To obtain a usable signal sample, place the counter's pickup antenna near the MFJ-8621A PA section--or install a sampling tap in the coax line leading to your dummy load. Use the CALIBRATE function on your TNC or short pin-3 of the data jack (PTT Line) to ground to key your transmitter's PTT line. Refer to Figure 3 on page 14 for specific locations on the pc board.

- [] Key the PTT line and check for a stable counter reading.
- [] Using an insulated tuning wand, adjust L6 to the exact operating frequency.
- [] Key and unkey the transmitter a couple of times to confirm setting.

Alternatively, if you don't have access to a good VHF counter, you may use a synthesized HF receiver for approximate calibration. To pick up the transmitter crystals fundamental signal, place a short antenna pickup wire near the MFJ-8621A and tune your HF receiver to the exact frequency stamped on the transmit crystal case (in the 18-MHz range). Next, key the transmitter PTT line and adjust L6 for zero beat. You must be precise; any frequency error appearing at 18 MHz will be multiplied 8 times at 145 MHz!

Receiver Oscillator:

Your MFJ-8621A has a unique built-in feature that allows you adjust the receiver oscillator by using the calibrated MFJ-8621A transmitter signal as a reference. You'll need an accurate DC voltmeter (or DVM) and an insulated tuning wand for this adjustment. Refer to Figure-3 for locations on the pc board:

- [] Locate DISC-TP (discriminator test point) in front of the radio's data jack.
- [] Set up voltmeter to measure DC readings in the 3-volt range.
- [] Connect the voltmeter to DISC-TP.
- [] Key the transmitter on.
- [] Adjust L4 for a DISC-TP reading of 2.5 volts.

The MFJ-8621A is now calibrated to transmit and receive on the same frequency.

To calibrate your MFJ-8621A receiver for a frequency different than the transmitter (i.e. for split-channel operation), you can substitute a 2-Meter HT for your signal source. First, connect a dummy load to the HT antenna jack (a 47-Ohm 1/4-W resistor is okay). Set your HT for low-power simplex operation and dial in the desired calibration frequency. Now, follow the procedure outlined above, substituting the HT as your signal source.

MORE ABOUT 9600-BAUD FSK PACKET SIGNALS:

The familiar "braaap" generated by 1200-baud packet signals is a combination of 1200 and 2200-Hz sine-wave tones beating together. Although the information being conveyed by these tones is digital, the transmission system itself is analog and falls within the range of normal speech. Unlike 1200-baud packet, 9600-baud signals are transmitted by binary FSK. To understand how this works, suppose you set your radio at 145.000 MHz with the modem adjusted for 3-KHz deviation. Anytime the TNC sends a 1, the transmitter should flip 1.5 KHz high in frequency to generate a carrier at 145.0015 MHz. When the TNC sends 0, the transmitter should flop 1.5 KHz low to generate a carrier at 144.9985 MHz. This is called FSK-FM (frequency-shift keyed FM), and there are no analog tones involved--only a rapid switching back and forth between binary states. In fact, 9600-baud signals sound more like white noise rather than tones when monitored on a conventional FM receiver. Data signals of this type require significantly more bandwidth than normal speech. Extended low-frequency response is needed to sustain prolonged strings of 1s or 0s, and extended high-frequency response is needed to provide a fast rise time when the signal changes state. This is why 9600-baud receivers typically use wider IF filters and special RX-FSK output circuits--and why transmitters often use "direct-FM" modulators which are especially adapted for FSK.

SENDING AND RECEIVING 9600-BAUD DATA:

Although 9600 baud packet is much faster than 1200 baud, it is also much less forgiving of marginal signal paths. For one thing, you'll probably need about 5-6 dB in additional signal strength to overcome wideband noise generated by the receiver's unusually-broad IF and audio passbands. Also, 9600-baud signals are extremely vulnerable to phase shift, which means multi-path reflections between stations must be held to a minimum. Finally, your transmitter and receiver must be accurately adjusted to frequency and the transmit deviation set for the correct shift.

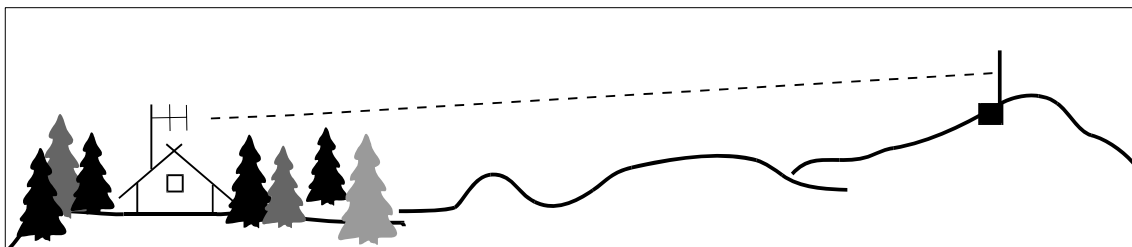

It's best to think "pipeline" when setting up point-to-point 9600-baud links. A carefully-aimed yagi generally provides better quieting and less multi-path than omni-directional antennas. If you are selecting a remote site for your station, please remember the MFJ-8621A is a \$120 amateur radio product and not a \$5000 commercial repeater! Avoid high-IMD locations if you can, or be prepared to provide additional filtering to reduce the effects of intermod and desensing from nearby transmitters. Also, avoid unheated buildings; the MFJ-

8621A does not come equipped with a crystal oven to maintain its operating frequency over a wide temperature range. Finally, make certain your transmitter is not interfering with commercial services sharing the site. Setting up a node for 9600 takes a little more care, but once you are "up and running", you can sit back and watch massive files pump through in a matter of seconds!

IN CASE OF DIFFICULTY:

Many equipment problems can be traced to simple setup errors or minor malfunctions that are easily corrected. Before contacting the MFJ factory for help, please take a few minutes to read through the list of symptoms below and check out all appropriate suggestions. If the problem persists, refer to the technical assistance section in the Appendix.

1. Unable To Copy Off-Air Signals:

- Improper TNC setup (consult TNC manual and double-check setup).
- Defective antenna or interconnect cables (check for shorts, opens, etc.).
- TNC or computer RFI (install cabinet covers, check cable shields).
- Wrong crystal installed at Y2 (RX crystal should be in the 44-MHz range).
- 1200-baud filter on, blocking 9600-baud reception (remove JMP-1).

2. Unable To Connect:

- Transmitter or receiver off-frequency (see crystal-oscillator calibration).
- Incorrect deviation (see FM-deviation adjustment).
- Trying to copy 9600-baud data with AFSK filter on. (Remove JMP-1).
- Using wrong modulator (consult manual, check JMP-2, JMP-3).
- Insufficient signal strength (check antenna orientation).
- Node overloaded with traffic (wait for things to quiet down).

3. Transmitter Erratic Or Inoperative:

- Insufficient power source (check voltage of power supply under load).
- Wrong crystal installed at Y3 (crystal should be in the 18-MHz range).
- High-VSWR antenna (check antenna with bridge -- should be 2:1 or less).
- Transmitter locked out because TNC is not equipped with DCD circuit.

IMPORTANT OPERATOR NOTES:

Your MFJ-8621A is specially designed to work with TNCs that are DCD equipped. If your TNC does not have data carrier detect circuitry, it will read the MFJ-8621A's unsquelched audio as an incoming signal and will not allow the data radio to transmit.

Your MFJ-8621A is not VSWR protected and will not tolerate prolonged operation into high-VSWR antennas. Most commercial antenna installations provide a VSWR or 1.5:1 or less, and this is a good rule of thumb to follow for VHF amateur installations. Also, do not retune RF circuits in your MFJ-8621A; this should only be done at the factory by a trained technician with access to correct procedures and instrumentation. MFJ cannot be held responsible for the on-air performance of radios subjected to unapproved tampering.

Finally, the MFJ-8621A is not FCC type accepted for commercial radio service and is intended solely for amateur use. Do not attempt to adapt this unit for commercial applications, and always test for interference to other radio services when using the MFJ-8621A in amateur service at a shared commercial site.

APPENDIX**Technical Assistance**

If you have any problem with this unit first check the appropriate section of this manual. If the manual does not reference your problem or your problem is not solved by reading the manual, you may call *MFJ Technical Service* at **601-323-0549** or the *MFJ Factory* at **601-323-5869**. You will be best helped if you have your unit, manual and all information on your station handy so you can answer any questions the technicians may ask.

You can also send questions by mail to MFJ Enterprises, INC., 300 Industrial Park Road, Starkville, MS 39759; by FAX to **601-323-6551**; through Compuserve at 76206,1763; or by email to 76206.1763@Compuserve.com. Send a complete description of your problem, an explanation of exactly how you are using your unit, and a complete description of your station.

Replacing the Fuse Link

Replace Fuse Link
With #32 Wire

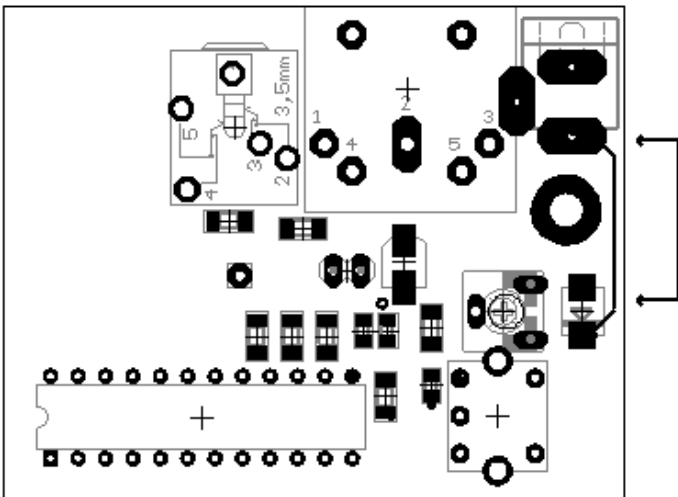

The MFJ-8621A has a thin foil trace on the pc board that acts as a line fuse. This trace connects power to the rest of the circuitry and may "burn out" under certain conditions (such as when the MFJ-8621A is subjected to a reversed polarity power). If your Data Radio does not operate and you suspect that the line fuse is broken follow these steps:

1. Remove the cover and inspect the fuse line. It may be necessary to test the fuse for continuity.
2. If the line is broken replace it with a length of #32 wire of approximately the same length. You may optionally replace the line with a heavier gauge of wire and protect the unit with a 2 amp fast-blow fuse.
3. Replace the cover and screws.

DCD Setup

To use the **KPC-9612** at 9600 baud with the MFJ-8621A:

1. Enter the command CD SOFTWARE at the cmd: prompt.
2. Set the 9600 receive level jumper (J9) to "ON" (both pins shorted together).
3. Set the 9600 equalization header for "variable" (pin 2 shorted to center).
4. Set the 9600 equalization pot (R33) from approx. 11 to 12 o' clock.
5. Set 9600 baud drive jumper (J7) to low range (jumper one pin only).
6. Set the 9600 baud drive control (R32) to midrange.

To use the **KPC-3** at 1200 baud with the MFJ-8621A:

1. Enter the command CD SOFTWARE at the cmd: prompt.
2. Set the AFSK level jumper (J3) to "high range" (both pins shorted together).
3. Set the 1200 transmit drive level control (R13) to 3.5 KHz. transmit deviation as described in your KPC-3 reference manual.

FULL 12 MONTH WARRANTY

MFJ Enterprises, Inc. warrants to the original owner of this product, if manufactured by MFJ Enterprises, Inc. and purchased from an authorized dealer or directly from MFJ Enterprises, Inc. to be free from defects in material and workmanship for a period of 12 months from date of purchase provided the following terms of this warranty are satisfied.

1. The purchaser must retain the dated proof-of-purchase (bill of sale, canceled check, credit card or money order receipt, etc.) describing the product to establish the validity of the warranty claim and submit the original of machine reproduction or such proof of purchase to MFJ Enterprises, Inc. at the time of warranty service. MFJ Enterprises, Inc. shall have the discretion to deny warranty without dated proof-of-purchase. Any evidence of alteration, erasure, or forgery shall be cause to void any and all warranty terms immediately.
2. MFJ Enterprises, Inc. agrees to repair or replace at MFJ's option without charge to the original owner any defective product under warrantee provided the product is returned postage prepaid to MFJ Enterprises, Inc. with a personal check, cashiers check, or money order for **\$7.00** covering postage and handling.
3. MFJ Enterprises, Inc. will supply replacement parts free of charge for any MFJ product under warranty upon request. A dated proof of purchase and a **\$5.00** personal check, cashiers check, or money order must be provided to cover postage and handling.
4. This warranty is **NOT** void for owners who attempt to repair defective units. Technical consultation is available by calling (601) 323-5869.
5. This warranty does not apply to kits sold by or manufactured by MFJ Enterprises, Inc.
6. Wired and tested PC board products are covered by this warranty provided **only the wired and tested PC board product is returned**. Wired and tested PC boards installed in the owner's cabinet or connected to switches, jacks, or cables, etc. sent to MFJ Enterprises, Inc. will be returned at the owner's expense unrepaired.
7. Under no circumstances is MFJ Enterprises, Inc. liable for consequential damages to person or property by the use of any MFJ products.
8. **Out-of-Warranty Service:** MFJ Enterprises, Inc. will repair any out-of-warranty product provided the unit is shipped prepaid. All repaired units will be shipped COD to the owner. Repair charges will be added to the COD fee unless other arrangements are made.
9. This warranty is given in lieu of any other warranty expressed or implied.
10. MFJ Enterprises, Inc. reserves the right to make changes or improvements in design or manufacture without incurring any obligation to install such changes upon any of the products previously manufactured.
11. All MFJ products to be serviced in-warranty or out-of-warranty should be addressed to **MFJ Enterprises, Inc., 300 Industrial Park Road, Starkville, Mississippi 39759, USA** and must be accompanied by a letter describing the problem in detail along with a copy of your dated proof-of-purchase.
12. This warranty gives you specific rights, and you may also have other rights which vary from state to state.