

MFJ 17-Meter QRP Transceiver

Model MFJ-9017

INSTRUCTION MANUAL

CAUTION: Read All Instructions Before Operating Equipment

MFJ ENTERPRISES, INC.

P.O. BOX 494, MISSISSIPPI STATE, MS 39762, USA

INTRODUCTION:

Congratulations on your choice of the MFJ-9017 17-Meter QRP transceiver. Please read this manual carefully before attempting to operate your new radio. Let's begin with an introduction to some special features we think you'll like!

EASY TO OPERATE: The MFJ-9017 is extremely simple to set up and operate (much easier than a complex multi-band digital radio).

GREAT SENSITIVITY: The MFJ-9017 receiver is sensitive -- right down to the noise floor of the band. Plus, we include a four-pole front-end filter, double-balanced mixing, and careful gain distribution to knock down intermod.

EXCELLENT SELECTIVITY: A tight 750-Hz CW bandwidth crystal filter fights unwanted QRM and noise to the max! Add our optional MFJ-726 NARROW AUDIO FILTER for even more selectivity.

SMOOTH AND STABLE VFO: A special wide-spaced reduction-drive VFO capacitor glides slowly across the band (no drift or touchy tuning). Add the convenience of true Receive Incremental Tuning (RIT), and you'll think you're operating a "big rig"!

EASY ON THE EARS: You'll appreciate how our graceful AGC tracks the signals you want to hear -- and NEVER locks onto strong adjacent signals outside the audio bandpass. In transmit, enjoy crystal-clear 700-Hz sinewave sidetone (no buzzy high-pitched square waves). Stop sending, and the receiver snaps back to life instantly -- at full sensitivity -- thanks to our exclusive "AGC Instant Recovery Circuit" (TM). There's plenty of audio power from the built-in 3" speaker or from your favorite phones.

RUGGED TRANSMITTER: The MFJ-9017 delivers full QRP output, tolerates up to 3:1 VSWR, and easily survives momentary feedline shorts or opens. Our adjustable-holed T/R switching is so fast, you can set it for full QSK during contests! And 700-Hz offset is automatic; just like on a big rig. For added convenience, install the optional MFJ-412 CURTIS IAMBIC KEYSER MODULE and hook up your favorite set of paddles.

GO PORTABLE: Take your MFJ-9017 QRP station anywhere with the MFJ-1771 PORTABLE DIPOLE or matching MFJ-971 QRP TUNER. Add an MFJ-4114 RECHARGING NiCd POWER PACK, and head for the hills; the MFJ-9017 can take it! All circuitry is constructed on a rugged double-sided G-10 plate-through pc board and housed in a durable aluminum cabinet (no sheet metal screws; we use PEM nuts).

These features add up to hour after hour of operating pleasure -- in arm-chair comfort. Best of all, your radio is fully backed by MFJ's exclusive unconditional "No Matter What" 1-year guarantee.

TECHNICAL SPECIFICATIONS:**RECEIVER SECTION:**

Frequency Coverage:	18.060-18.115 MHz (18.068-18.110)
Receiver Type:	Single conversion superhet
VFO Frequency:	2.060-2.115 MHz
IF Frequency:	16 MHz
IF Selectivity:	750-Hz ladder filter
AGC:	Audio-derived, instant T/R recovery
Sensitivity:	Better than 18-Mhz noise floor
RIT:	1 KHz range
Audio:	8 Ohms, speaker or external phones
Audio Filter (opt):	700-Hz 4-pole active, unity gain
Receive Current:	50 mA

TRANSMITTER SECTION:

Keying:	High-Z, Semi-QSK
Keyer (opt):	Curtis 8044ABM Ismbic
Sidetone:	700-Hz sinewave
RF Power Output:	> 4 W, Vcc 13.8 V, 50-Ohm load
VSWR Tolerance:	3:1 VSWR
Transmit Current:	1 Amp at 13.8 VDC
T/R Switch:	Semi-QSK, adjustable hold

BLOCK DIAGRAM:

FIGURE 1.

THEORY OF OPERATION:

If you are technically inclined, read this page for the "inside scoop" on your rig. Please refer to Figure 1.

The MFJ-9017 receiver is a single-conversion superhet design. Received signals are pre-selected by 4-pole bandpass filter at L1-L2, then amplified and converted to 12-MHz by double-balanced mixer U1. The required 6.1-MHz VFO signal is generated by U1's internal oscillator. A varactor RIT circuit (switched at Q2) provides VFO shift on receive only. T1 matches the output of mixer U1 into a narrow 750-Hz crystal ladder filter Y1-Y4.

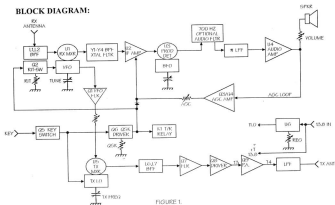
U2 provides 12-MHz IF amplification and gain control. In receive mode, audio-derived AGC maintains constant signal output. During transmit, U2 gain is clamped low -- and the receiver remains on to generate sidetone. The receiver recovers to full gain instantly when clamping voltage is removed.

DBM Product Detector U3 provides audio recovery and gain. A 12-MHz VXO circuit at U3 generates BFO injection. U3 output passes through a pi-section RC filter to reduce wide-band noise. The optional MFJ-726 NARROW AUDIO FILTER is inserted at this point to provide an extremely narrow audio passband response at 700 Hz.

Audio Amplifier U4 drives the AGC and provides output power for speaker or phones. An AGC feedback signal is rectified and amplified through DC amplifiers Q3/Q4 (AGC drive and hang time are set at Q3, and Q4 sets AGC bias for U2). U4 operates at full loop gain, and volume level is set by an adjustable attenuator.

To transmit, DC switch Q5 keys TX Mixer U5 and turns on Relay Driver Q6 -- closing T/R relay K1. K1, in turn, switches the antenna and routes unregulated Vcc to Q7-Q9, a TX LED, Q2, and the AGC clamping circuit. RC circuitry at Q6 sets QSK hold.

U5 mixes the 6.1-MHz VFO signal with a 12-MHz Transmit Oscillator signal to produce 18.1-MHz CW. Buffer Q1 isolates the VFO and sets injection level to U5. The Transmit Oscillator VXO offsets the BFO by 700 Hz -- providing automatic CW offset and enabling the receiver to generate a pure 700-Hz sinewave sidetone. A four-pole bandpass filter at L6-L7 attenuates unwanted mixer products, and follower Q7 matches the high-Q filter to driver Q8. Q8, operating in class AB, excites class C PA stage Q9 through matching transformer T3. T4 matches the output of Q9 into a 50-Ohm 1/2-wave filter which suppresses harmonics and other unwanted transmitter products.

Operating voltage to small-signal stages is regulated at 10.5 VDC by U6. This provides a regulation threshold of approximately 11.75 volts to facilitate 12-Volt battery operation. Individual LM78L05's clamp U1 and U5 at 5 volts Vcc.

MFJ-9017 CONTROL LOCATION AND FUNCTION:

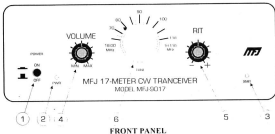

1. POWER SWITCH: Turns power on to the tranceiver.
2. "PWR" LED: Indicates when radio is turned on.
3. "XMIT" LED: Indicates when radio is transmitting.
4. VOLUME: Adjusts speaker or headphone volume level.
5. RIT: Shifts receiver frequency.
6. VFO TUNE: Selects tranceiver operating frequency.

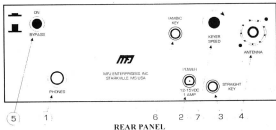

1. PHONE JACK: 3.5mm mono jack for low-Z phones or ext. speaker.
2. POWER JACK: 5.5mm OD, 2.1mm ID coaxial, (+) to center pin.
3. KEY JACK: 3.5mm mono jack for handkey (or most keyers).
4. ANTENNA JACK: SO-239 for standard coax plugs.
5. CW FILTER SWITCH: Activates MFJ-726 NARROW AUDIO CW filter.
6. IAMBIC KEYSER JACK: 3.5mm stereo jack for iambic keyer paddles.
7. KEYSER SPEED: Sets sending speed of MFJ-412 Iambic Keyer.

SETTING UP YOUR MFJ-9017 QRP STATION:

To put the MFJ-9017 on the air, you'll need a power source, a 17-Meter antenna, and a key (headphones optional). Here are some specific suggestions to help you get started:

1. POWER SOURCE: 12-15 V @ 1.2 A, (+) TO CENTER PIN

The MFJ-4114 AC/DC POWER PACK is especially designed for your radio. However, you may use any filtered DC power source capable of delivering 12-15 volts at 1.2 Amps (13.8 volts required for full RF output). The power connector at the rear of your MFJ-9017 is a 5.5mm OD, 2.1mm ID coaxial type jack. One 2.1mm plug is provided. Extra plugs are available from local Radio Shack stores under part number 274-1567. Make sure you connect the plus (+) lead to the CENTER PIN of the transceiver power plug.

For portable operation, install batteries in your MFJ-4114 power pack, or connect any battery capable of providing 12 Volts at 1 Amp directly to the MFJ-9017 power jack. Replace when pronounced key clicks appear on the sidetone (first indication that battery voltage has dropped below the transceiver's voltage regulator threshold).

2. KEY: ACCEPTS MOST TYPES -- USE 3.5mm MONO PLUG

The MFJ-9017 hi-Z keying circuit operates with mechanical keys, relay-output keyers, and most electronic keyers. The "straight-key" jack accepts a standard 3.5mm monoaural mini-plug. If you wish to plug your paddles directly into the radio, install the optional MFJ-412 CURTIS LAMBIC KEYSER MODULE (this accepts a 3.5mm stereo mini-plug). You may continue to use a straight-key in normal fashion with the keyer module installed.

3. ANTENNA: VSWR 3:1 OR LESS

The MFJ-9017 is tolerant of reactive loads, and accepts virtually any 17-Meter antenna with a VSWR of 3:1 or less. To get on the air, hook your regular station antenna to the transceiver's SO-239 connector -- or install a dedicated 17-Meter CW-band dipole such as the MFJ-1771. For non-resonant wire antennas, use a tuner such as the MFJ-971 which features a user-selectable 6-watt SWR range for QRP operation. Avoid operating into unmatched high-SWR antennas. This could result in transmitter instability and the generation of out-of-band spurious signals in violation of FCC rules. For specific QRP antenna suggestions, see "QRP Operating Tips" and "Simple 17-Meter Antennas".

4. HEADPHONES: 8-16 OHM IS BEST

If you use phones, consider purchasing a low-Z monoaural set like the Radio Shack #20-210 communications headset.

SIMPLE 17-METER ANTENNA SUGGESTIONS:

COAXIAL-FED DIPOLES: A CW-band wire dipole should measure about 26' (13' each leg). Feed with RG-58U or RG-8X; raise high and in the clear for best performance. If you have only one high support, make an inverted V. The "full sloper" (sloping dipole) is also an excellent single-support antenna with directivity.

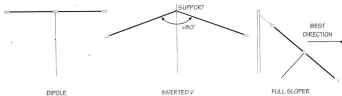

MFJ-1771 PORTABLE DIPOLE: As an alternative to making a coax-fed dipole, consider purchasing the pre-assembled MFJ-1771 antenna. This is a no-compromise 17-Meter folded dipole complete with 30' of feedline -- all made from light-weight 30-Ohm twinlead. Connect a random length of coax from the MFJ-1771 feedline to your rig and let the antenna's built-in 50-Ohm matching network do the rest. The antenna is pre-tuned, easy to handle, and very broad-banded!

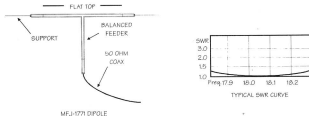

WARNING: CONSTRUCTING OR ERECTING AMATEUR RADIO ANTENNAS IN LOCATIONS WHERE THEY MAY COME INTO CONTACT WITH ELECTRICAL POWER LINES MAY RESULT IN ACCIDENTAL INJURY OR DEATH!

GETTING THE MOST FROM YOUR QRP STATION:

Spanning the globe with less power than it takes to light a Christmas-tree bulb is not only exciting, it borders on the miraculous. Yet, despite the vast distances involved, QRP enthusiasts consistently reach every corner of the planet -- sometimes running only microwatts! How do they do it? Here are some proven tips to help you work great with your MFJ-9017:

GROOM YOUR ANTENNA:

For multi-band antennas, inspect and clean all traps and contacting surfaces. Replace corroded hardware, dirty connectors, and aging coax. Retune for minimum SWR in the CW band. Verticals (1/4 or 5/8-wave) require at least 4 good 18-Mhz radials -- add them if needed.

Raise wire dipoles high and in the clear -- 30 to 60 feet is far superior to 10 or 20. Carefully prune for minimum SWR. If you have only one high support, install an inverted V or sloper.

Avoid "compromise" multi-band wire antennas if possible. A resonant dipole, yagi, or groundplane will generally yield more predictable results. When it comes to pure operating enjoyment, every dB you gain at the antenna pays off!

USE PROVEN DX OPERATING TECHNIQUES:

Be a good listener. Searching out and answering CQ's yields more contacts than repeatedly calling CQ.

When you DO call CQ, try signing "/QRP" at least once so stations will know you are running low power.

Never hesitate to call a weak DX station. They may be running low power or using a marginal antenna. You may be loud!

Be persistent. You may have to wait until the "big guns" make contact and move on. It pays to hang around.

Look before you leap. Wait for a momentary lull in the pile-up, then quickly slip in your call.

Set the VFO slightly up or down frequency and use the RIT control to tune in your station. This way you'll transmit above or below the pile-up -- increasing your chance of being heard.

Let DX stations know you are QRP by signing "/QRP" at the end of your call. If they hear "QRP", they may ask others to stand by.

Pay attention to DX forecasts and gray-line propagation. When the band is hot, power differences become less significant.

FIELD DAY AND OTHER "DX-PEDITION" OPERATING HINTS:

The MFJ-9017 is rugged, but you may want to consider your radio's limitations before you throw it into a backpack and head for Grand Cayman Island.

1. The MFJ-9017 case is an attractive matte-black -- not unlike the surface of a solar collector. For this reason, we recommend confining outdoor operations to shady areas!
2. The MFJ-9017 has no SWR over-protection. It is up to you to prevent the PA stage from "taking off into parasitic oscillation by providing a reasonable antenna. This means no bedsprings or barbed-wire fences (at least without a tuner).
3. Romps on sandy beaches and white-water canoe rides are great fun for humans, but not always good for radios. Sealing your MFJ-9017 in a plastic bag will protect it during transit.

QRPP (ULTRA-LOW POWER) OPERATION:

You may adjust your MFJ-9017 for any power level down to zero. However, YOU MUST AVOID OVERDRIVING THE TRANSMIT MIXER WHEN TURNING POWER BACK UP. OVERDRIVING CAUSES GENERATION OF SPURIOUS SIGNALS, AND YOUR RADIO MAY NO LONGER COMPLY WITH FCC RULES. Never attempt these power adjustments to your radio without a QRP wattmeter, dummy load, and familiarity with alignment procedures.

1. TO REDUCE POWER: Locate VFO trimpot behind the volume control (see Field Service diagram for exact location). Key radio and monitor power on a QRP wattmeter. Turn the VFO trimpot counter-clockwise (CCW) to set the desired RF power output level.
2. TO RESTORE FULL POWER: Connect QRP wattmeter and dummy load to rig. Confirm supply voltage is between 13.5 and 13.8 volts. Set VFO trimpot fully CCW. Key rig and advance VFO trimpot CW. Output should increase smoothly and rapidly. At 4 - 4.5 Watts, output may "plateau" before you hit the full CW position of the trimpot. If it does, adjust the trimpot back and forth to locate the exact point where the plateau first begins to occur. This is the correct VFO drive setting.

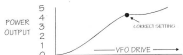

WARNING: NEVER SET VFO TRIMPOT TO EXCEED 4.5 WATTS OUTPUT. MFJ ENTERPRISES, INC. CANNOT ASSUME RESPONSIBILITY FOR PERFORMANCE OF ANY TRANSMITTER THAT HAS BEEN ADJUSTED OR MODIFIED IN THE FIELD.

**IN CASE OF TROUBLE, CHECK IT OUT FIRST -- THEN CALL US AT
800-647-TECH (800-647-8324)!**

Your MFJ-9017 is backed for one full year by MFJ's exclusive unconditional **"NO MATTER WHAT GUARANTEE"**. This means MFJ will repair or replace **ANYTHING** that goes wrong with your radio for the first year -- **no matter what!** And, MFJ Customer Service Technicians will be there to help you keep your rig in top shape for as long as you own it. Before you call, however, we ask that you check through this list of common problems first -- just to make sure it isn't something simple you can fix yourself!

1. RADIO WILL NOT POWER UP:

Check Power Plug -- is it loose? Broken supply wire?
Check Power Source -- is power supply or battery okay?
Check Reverse-polarity fuse -- thin pc track "opens" if (+) and (-) have been reversed (see page 12 for location).

2. NO SIGNALS RECEIVED:

Check Antenna -- is it disconnected? Broken or shorted leads?
Check Propagation -- geomagnetic storm? Dead band?

3. NO AUDIO:

Check Phone Jack -- is plug inserted, defeating the speaker?
Check Headphones -- broken wire or shorted plug?

4. WONT TRANSMIT, KEYS ERRATICALLY:

Check Key Plug or Keyer -- is key making contact? Broken wire?
Check Power Source -- is it powerful enough to operate radio?

5. KEY CLICKS ON SIDETONE, LOUD SIDETONE:

Check Power Source -- enough voltage to run radio under load?
Check Battery Voltage -- time to recharge?

6. ERRATIC OPERATION ON TRANSMIT:

Check SWR -- is antenna mis-adjusted or damaged?

7. RECEIVER INSENSITIVE OR AGC INEFFECTIVE:

Check TP-1, set AGC pot for 4.0 V reading (no signal).

8. RECEIVER INSENSITIVE, VOLUME LOW:

Check TP-2, set REG pot for 10.5 V.

9. EXCESSIVE VFO DRIFT:

Check Temperature -- is case heating in the sun? Rig on warm surface?

10. SIDETONE HIGH OR LOW IN FREQUENCY:

Check TX FREQ trimmer, readjust for a 700-Hz tone in speaker.

If these checks don't locate the problem, or if you don't feel qualified to make the prescribed adjustments, please call us for help at 800-647-TECH (800-647-8324).

FIELD ALIGNMENT PROCEDURES FOR THE MFJ-9017 TRANCEIVER:**SPECIAL TOOLS, PARTS, TEST EQUIPMENT:**

1. AC Power Supply, MFJ-4114 or 13.8 Volts @ 1.5 Amps
2. Sensitive Voltmeter (DVM or Analog)
3. Non-inductive Alignment Tool kit
4. Frequency Counter
5. QRP Wattmeter with 50-Ohm Resistive Dummy Load
6. 18.1-MHz Signal Generator or Weak Signal Source
7. (Optional) General Coverage Receiver -- Digital Readout

INITIAL TEST SET-UP: (see diagram on page 12)

- A. Remove tranceiver cover.
- B. Connect 13.8 Volts Power Supply to Power Jack.
- C. Connect Key to Jack.
- D. Remove CW Filter and Keyer modules if installed.
- E. Install shorting clip on pins 2 and 3 of CW Filter Header.
- F. Turn on unit.

VOLTAGE CHECKS AND ADJUSTMENTS: (use voltmeter)

- A. VOLTAGE REGULATOR: 10.5 V at TP2, adjust REG trimpot.
- B. RECEIVER AGC: 4.0 V at TP1, adjust AGC trimpot.
- C. RIT: Approx. 5.3 V at TP3 (leg of R16) when RIT knob at 12:00.

VFO CALIBRATION:

- A. Tune VFO dial to 18.090-MHz (mid-band).
- B. Set Frequency Counter probe near antenna jack; key radio.
- C. Adjust VFO CAL (L3) for 18.090-MHz readout.

BFO FREQUENCY CHECK AND ALIGNMENT:

- A. Connect Voltmeter to TP1 to read AGC voltage.
- B. Connect Frequency Counter to speaker output.
- C. Apply 18.090-MHz signal source to antenna jack.
- D. Tune in signal for maximum AGC voltage at TP1.
- E. Adjust Volume for a stable counter reading.

NOTE: Best MFJ-9017 CW response occurs when maximum AGC voltage at TP1 coincides with 700-Hz audio output. If maximum AGC occurs when CW tone is significantly above or below 700-Hz, adjustment is required. If okay, skip BFO alignment and move on.

- F. Reset BFO Trimcap until Voltmeter peak coincides with 700-Hz tone.
- G. To check suppression of opposite sideband -- tune through zero beat. Little or no signal should be audible on the low side. If suppression is poor, increase BFO frequency slightly (200-Hz) and recheck.
- H. Confirm BFO is on correct sideband -- signal note should increase in pitch as you tune up the band.

NOTE: If BFO is on wrong sideband, use a general coverage receiver to pick up the BFO signal (just below 12-MHz). Set the general coverage receiver dial to 11.996-MHz and adjust BFO trimcap for zero beat for ballpark setting. Now, repeat the BFO procedure described above for exact setting.

TRANSMITTER OSCILLATOR OFFSET (SIDETONE) ADJUST:

- A. Connect dummy load to antenna jack.
- B. Connect frequency counter to speaker output.
- C. Key transmitter, adjust TX FREQ trimcap for 700-Hz sidetone note.

RECEIVER SENSITIVITY CHECK:

- A. Connect 18.090-MHz signal source to antenna jack.
- B. Connect voltmeter to TP1 (AGC voltage).
- C. Tune in signal source for maximum AGC indication.
- D. Carefully touch up RX1, RX2, IF1, IF2 for max SIG meter reading.

TRANSMITTER BANDPASS FILTER ALIGNMENT:

- A. Connect QRP Wattmeter with dummy load to antenna jack.
- B. Key transmitter, adjust VFO trimcap CCW for 3-Watts RF power output.
- C. Carefully touch up TX1 and TX2 for peak output.

TRANSMITTER MIXER LEVEL:

- A. Turn VFO trimpot fully CW. Key rig.
- B. Advance VFO trimpot CW while watching RF output level. RF output should increase rapidly. Continue CW until full CW -- OR until further rotation has a reduced effect on output power (mixer gain compression).
- C. Set VFO trimpot for TOP of the linear region (fully CW for some radios). Do not allow transmitter output to exceed 4.5 Watts!

CAUTION: Pushing the VFO trimpot past 4.5-Watts output may give the appearance of producing greater transmitter power. However, much of this measured output may be spurious energy generated by an overdriven transmitter mixer. Mixer drive must be set as outlined above -- or with the aid of a lab-quality spectrum analyzer -- for the MFJ-9017 transmitter to comply with FCC Standards.

NOTE: The FCC requires HF QRP transmitters to exhibit at least 30 dB suppression of unwanted harmonics and spurious products. A properly adjusted MFJ-9017 transmitter will easily exceed FCC requirements.

This completes field alignment of the MFJ-9017 Tranceiver. If your tranceiver fails to operate properly after following these procedures and adjustments, please call 800-647-TECH (800-647-8324) for help -- or return the unit to the factory for authorized service.

INTERNAL ADJUSTMENT LOCATIONS AND PARTS PLACEMENT, MFJ-9017:

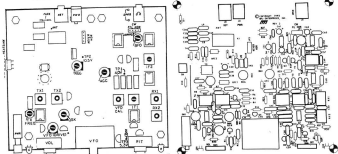

*If reverse-polarity track-fuse opens, install a miniature 1.5-A pigtail fuse or a 3/4" hair-pin loop of #32 wire.

DC VOLTAGE CHART - TROUBLESHOOTING GUIDE:

For advanced troubleshooters, the following are typical DC voltages found in the MFJ-9017:

- Vcc = 13.5 (Supply Voltage)
- TP1 = 4.0 (AGC Bias Voltage)
- TP2 = 10.5 (LM-317 Regulated Voltage)
- TP3 = 5.3 (Zero shift RIT Voltage)

INTEGRATED CIRCUITS:

Pin	----- RX -----			--- TX ---	
	U1	U2	U3	U4	U5
1	1.3	9.4	1.3	1.4	1.3
2	1.3	9.4	1.3	0.0	1.3
3	0.0	0.0	0.0	0.0	0.0
4	3.8	3.1	3.8	0.0	3.8
5	3.8	4.3	3.8	6.8	3.8
6	5.0	3.1	5.1	13.3	5.0
7	4.5	0.0	4.5	6.6	4.5
8	5.0	9.4	5.2	1.4	5.0

BIPOLAR AND JFET DEVICES:

D/E = Drain/Emitter S/B = Source/Base G/C = Gate/Collector

	----- RX -----					--- TX ---			
	Q1	Q2	Q3	Q4	Q5	Q6	Q7	Q8	Q9
D/E	10.2	3.6	9.6	10.1	10.4	---	12.7	0.14	---
S/B	1.8	6.8	2.8	9.4	10.3	---	1.9	0.8	---
G/C	---	---	---	4.3	---	13.3	---	13.5	13.5

MFJ-9017 PARTS LIST

Designation	Description	Part #	Designation	Description	Part #
C1	22pF, 50V Multilayer	205-0022	K1	12V, Relay	408-2035
C2,14,17,19,21,27,28,31	.1uF, 50/100 V Disc	200-0005	L1,2,6,7	1.5uH, Rod Inductor	402-3402
C9,52,56,58,60,68,69	.1uF, 50/100 V Disc	200-0005	L3	Yellow, Inductor	402-3404
C3,5,7,16,23,37,41,42	0.01uF, 25/50V Disc	200-0004	L4,5	4.7uH, Inductor	401-0099
C46,63	0.01uF, 25/50V Disc	200-0004	L8,9	10T Inductor	10-10100
C4,55	47pF, 50V Multilayer	205-0021	Q1,2,3,7	2N5486	305-6004
C6	100pF, 50V Disc	200-0003	Q4,5	2N1966	305-0002
C8	22uF, 16V Electrolytic	203-0015	Q6	2N1904	305-0001
C3,10,13,65	100pF, 50V Multilayer	205-0100	Q8	2N5109	305-0017
C11	4.7pF, 50V Disc	200-0012	Q9	MGF-476	305-3476
C12	56pF, 500V Disc	200-1056	R1,10,13,15,24,27,33	100 Ohm, 1/4 Watt	100-0003
C15,18,22,29	0.001uF, 1KV Disc	200-2024	R2,4,14,16	100K Ohm, 1/4 Watt	100-0029
C20,53	10uF, 35V Electrolytic	203-0012	R3,17,21,25,29,32	10K Ohm, 1/4 Watt	100-0017
C24,25,26,64	50pF, 50V Multilayer	205-0180	R5	27uH, Inductor	401-0078
C30	33pF, 50V Multilayer	205-0020	R6	270 Ohm, 1/4 Watt	100-0007
C32,33	560pF, 160V Polyester	202-0022	R7	12K Ohm, 1/4 Watt	100-0051
C34	.1uF, 50V Multilayer	205-2210	R8,20,30,34	1K Ohm, 1/4 Watt	100-0010
C35	180pF, 50V Multilayer	205-0180	R9	3.3 Ohm, 1/4 Watt	100-0011
C36	68pF, 50V Multilayer	205-0068	R11,12	220 Ohm, 1/4 Watt	100-0005
C38	330pF, 50V Multilayer	205-0330	R18,19	47K Ohm, 1/4 Watt	100-0023
C39	56pF, 50V Multilayer	205-0056	R22	330 Ohm, 1/4 Watt	100-0074
C40	3.3pF, 500V Disc	200-1003	R23	4.7K Ohm, 1/4 Watt	100-0014
C43,47	330pF, 500V Disc	200-1000	R26	56K Ohm, 1/4 Watt	100-0052
C44	560pF, 500V Disc	200-1500	R28	27K Ohm, 1/4 Watt	100-0021
C45,48	430pF, 50V Multilayer	205-0470	R31	1M Ohm, 1/4 Watt	100-0040
C50	330pF, 500V Disc	205-8022	R35,36,39,40	2.2K Ohm, 1/4 Watt	100-0012
C51,61	2.2uF, 16V Tan	203-0003	R37	15 Ohm, 1/4 Watt	100-0075
C54,59	100uF, 16V Electrolytic	203-0031	R38	22 Ohm, 1/4 Watt	100-0112
C57	047uF, 50V Disc	205-1010	R41,42,43	1K Ohm, Tripoint	104-4001
C62	2.2uF, 35V Electrolytic	203-0002	R46	100K Ohm, Tripoint	104-4004
C66,67	12-100pF, 250V Trimmer	204-0010	R45	250 Ohm, Pot	105-0007
C70	5-50pF, 750 Tuning Cap	204-5050	R46	10k Ohm, Pot	105-0002
C71,72	18pF, 50V Multilayer	205-0018	R/C1,2	4T, Inductor	10-10121
CR1	MOV5753 Rad LED	320-0001	S01	Switch	504-0022
CR2	Green LED	320-0002	T1,72	25K 1K Inductor	402-3123
D1	1N5235/3	301-5235	T3	9:1 transformer	10-10090
D2,3,4,5	1N4148	300-0003	T4	7T Toroid	10-10047
D6	MY2104	315-2104	U1,3,5	NE602	311-1002
D7	1N4001	300-1004	U2	MC1350P	311-1045
J1	3.5mm Stereo	601-5013	U4	LM386	311-0386
J2	3.5mm Mono	601-5012	U6	LM317T	307-1021
J3	2.1mm Coaxial	601-4021	U7,8	78L05AC	307-0010
J01,2	4 Pin Header	612-0014	Y1,2,3,4,5,6	16-MHz Crystal	405-0067

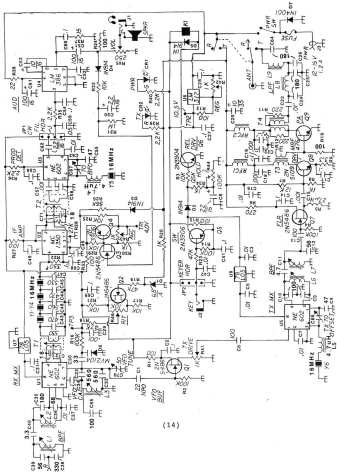

SCHEMATIC DIAGRAM, MFJ-9017

FULL 12 MONTH WARRANTY

MFJ Enterprises, Inc. warrants to the original owner of this product, if manufactured by MFJ Enterprises, Inc. and purchased from an authorized dealer or directly from MFJ Enterprises, Inc. to be free from defects in material and workmanship for a period of 12 months from date of purchase provided the following terms of this warranty are satisfied.

1. The purchaser must retain the dated proof-of-purchase (bill of sale, canceled check, credit card or money order receipt, etc.) describing the product to establish the validity of the warranty claim and submit the original of machine reproduction or such proof of purchase to MFJ Enterprises, Inc. at the time of warranty service. MFJ Enterprises, Inc. shall have the discretion to deny warranty without dated proof-of-purchase. Any evidence of alteration, erasure, or forgery shall be cause to void any and all warranty terms immediately.
2. MFJ Enterprises, Inc. agrees to repair or replace at MFJ's option without charge to the original owner any defective product under warranty provided the product is returned postage prepaid to MFJ Enterprises, Inc. with a personal check, cashier's check, or money order for \$7.00 covering postage and handling.
3. MFJ Enterprises, Inc. will supply replacement parts free of charge for any MFJ product under warranty upon request. A dated proof of purchase and a \$5.00 personal check, cashier's check, or money order must be provided to cover postage and handling.
4. This warranty is NOT void for owners who attempt to repair defective units. Technical consultation is available by calling (601) 323-5869.
5. This warranty does not apply to kits sold by or manufactured by MFJ Enterprises, Inc.
6. Wired and tested PC board products are covered by this warranty provided **only the wired and tested PC board product is returned**. Wired and tested PC boards installed in the owner's cabinet or connected to switches, jacks, or cables, etc. sent to MFJ Enterprises, Inc. will be returned at the owner's expense unrepaid.
7. Under no circumstances is MFJ Enterprises, Inc. liable for consequential damages to person or property by the use of any MFJ products.
8. **Out-of-Warranty Service:** MFJ Enterprises, Inc. will repair any out-of-warranty product provided the unit is shipped prepaid. All repaired units will be shipped COD to the owner. Repair charges will be added to the COD fee unless other arrangements are made.
9. This warranty is given in lieu of any other warranty expressed or implied.
10. MFJ Enterprises, Inc. reserves the right to make changes or improvements in design or manufacture without incurring any obligation to install such changes upon any of the products previously manufactured.
11. All MFJ products to be serviced in-warranty or out-of-warranty should be addressed to MFJ Enterprises, Inc., 300 Industrial Park Road, Starkville, Mississippi 39759, USA and must be accompanied by a letter describing the problem in detail along with a copy of your dated proof-of-purchase.
12. This warranty gives you specific rights, and you may also have other rights which vary from state to state.

MFJ ENTERPRISES, INC.

300 Industrial Park Road
Starkville, MS 39759

MFJ-9017 Manual

Version 3B

Printed In U.S.A. 6/95