

## **INTRODUCTION**

Congratulations on your choice of the MFJ-9420 20-Meter transceiver. The MFJ-9420 is specially designed to deliver performance you never thought possible from a low power radio. Please read this manual carefully before attempting to operate your new radio. Lets begin with an introduction to some special features we think you'll like!

## **FEATURES**

**EASY TO OPERATE:** The MFJ-9420 is an easy-to-operate," back to basics" radio. Operate the unit with ease in minutes!

**GREAT SENSITIVITY:** Quiet DBM front end and lots of overall gain for great sensitivity. If the signal is there, you will hear it!

**ANALOG S-METER:** Adjust the tuner or aim the beam with pinpoint accuracy. A calibrated analog S-Meter measures even the smallest variations in signal strength. The meter also monitors your speech processing level on transmit.

**EXCELLENT SELECTIVITY:** Sharp ladder filter cuts adjacent chatter and focuses transmitter power where you need it most for great selectivity.

**SMOOTH, STABLE VFO:** Effortless tuning with custom manufactured 8:1 reduction drive ball bearing VFO tuning capacitor provides smooth and stable VFO. Fine Tune lets you zero-in smoothly.

**POWERFUL AF OUTPUT:** Big audio and powerful AF output even in noisy locations from a special Philips BTL audio chip and rugged 3" speaker.

**FULL-TIME RF SPEECH PROCESSING:** Commanding speech cuts through QRM and competes with radios running far more power. Compare with your 100-watt rig. You will be amazed by the signal reports!

**TRAVEL LIGHT:** Packs the same punch as 50-Watt radios without the heavy 10 Amp power supply! Designed to run on NiCd's or the ultra light MFJ-4110 AC wall adapter supply.

**RUGGED TRANSMITTER:** Bullet-proof Motorola PA transmitter runs cool, and tolerates 3:1 VSWR accidentally opened feedlines or feedline shorts.

**MADE TO LAST:** Conservative design, with a premium plate through pc board, quality components, handsome brushed aluminum panel, and a tough vinyl clad case ensure years of dependable service.

**CW ADAPTER AVAILABLE:** Install the MFJ CW adapter board jump to the low end to work CW. Semi-break in keying and sidetone.

At home or on the go, you will enjoy countless hours operating the MFJ-9420. Best of all, it is fully backed by MFJ's exclusive "No Matter What" 1 year guarantee. If it breaks, we will take care of it!

## QUICK START INSTRUCTIONS:

You will need three things to get your MFJ-9420 on the air fast:

- [ ] 12 14 Volt 2 Amp Power Source
- [ ] 600 Ohm Dynamic PTT Microphone
- [ ] 20-Meter Antenna

1. **POWER SUPPLY:** The MFJ-4114 AC/NiCd Portable Power Pack or MFJ-4110 AC wall-adapter supply are Especially designed to run the MFJ-9420. You may also use any 13.8 Volt supply or 10-cell NiCd pack as long as it delivers 2 A on peaks (12 Volt supplies will work fine but at reduced RF output). Use a 5.5mm OD x 2.1mm coaxial type power plug (Radio Shack 274-1567) with (+) connected to the center pin.

2. **MICROPHONE:** The MFJ-9420 speech processor circuit was designed around the companion MFJ-290 600 Ohm Dynamic Microphone. Radio Shack's 21 1172 replacement microphone also plugs in without modification and works well. If the mic you select requires a plug, install a 5 Pin DIN connector (Radio Shack 274 003) as shown:

Pin 3: PTT Line

Pin 4: Mic Line

Pin 1,2,5: Ground

3. **ANTENNA:** The MFJ-9420 will function with any 20-Meter antenna exhibiting a VSWR of 3:1 or less (your home station antenna or the MFJ-1772 Portable Dipole should work fine). **AVOID USING ANTENNAS WITH UNKNOWN OR HIGH VSWR.** The MFJ-9420 PA is not protected by high VSWR shutdown circuitry and you may generate out-of-band parasitics if a high VSWR load is present.

## IMPORTANT OPERATING NOTES

Your MFJ-9420 features a very potent speech processor. **PLEASE RESIST THE TEMPTATION TO SHOUT OR "CLOSE TALK" INTO THE MICROPHONE IN ORDER TO BE HEARD!** Instead, hold the mic about 2" away and speak normally. The S-Meter should deflect about 1/2 scale as you speak although this may vary somewhat with antenna load. When operating in noisy environments, you may find it necessary to turn down the mic gain control (a screwdriver adjustment located on back panel) to reduce background noise.

The MFJ-9420 uses an analog VFO tuning dial that is inherently less accurate than digital readouts (on the plus side, analog tuning reduces phase noise, lowers power consumption, and saves you money). Please take the potential for dial error into account when operating near the edge of your authorized sub band.

**TYPICAL SPECIFICATIONS**

**RECEIVER SECTION:**

Frequency Coverage:	14.150 14.350 MHz (14.000-14.100)*
Receiver Type:	Single conversion <b>superhet</b>
VFO Frequency:	4.150-4.350 MHz (4.000-4.100)*
IF Frequency:	10 MHz
IF Selectivity:	-6 dB at 2.5 KHz
AGC:	Audio-derived
Sensitivity:	<.5 uV for 12 dB S/N
Audio:	>1 Watt into 8 Ohms at 10% THD
Receive Current:	50-100 mA typical

**TRANSMITTER SECTION:**

RF Power Output:	10W Average Speech (8-10W CW)*
VSWR Tolerance:	3:1 VSWR
Maximum Current:	2.2 Amps peak at 13.8 VDC
Audio Enhancement:	RF compression processor

\* Requires CW adapter module

**BLOCK DIAGRAM:**

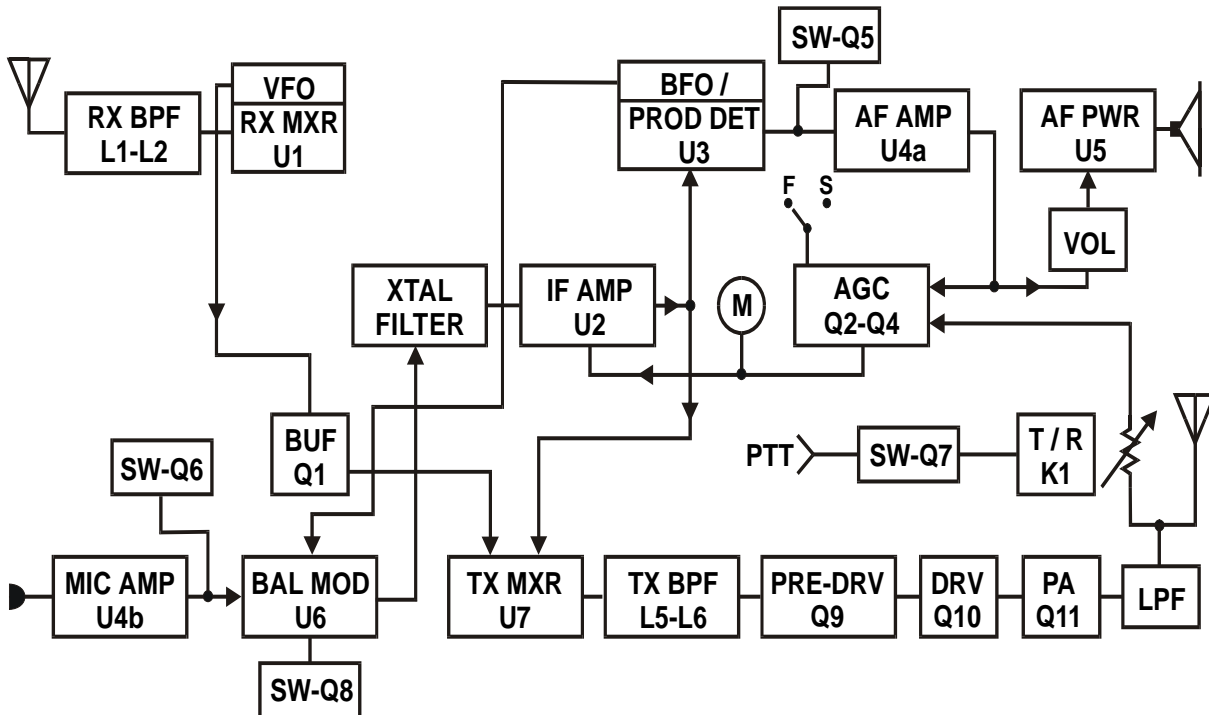

## THEORY OF OPERATION

### RECEIVER:

Four-pole bandpass filter L1-L2 preselects incoming 14 MHz signals. Active mixer U1 amplifies and converts signals to 10 MHz using a self generated 4 MHz VFO signal. Crystal ladder filter Y1-Y6 sets message channel bandwidth (diode switching routes transmit and receive signals through the filter and U2). IF-amplifier U2 provides AGC controlled IF gain in RX and RF compression speech processing in transmit.

The DC amplifier Q3/Q4 drives the AGC input of U2 and the S-meter circuit. In RX, AGC is audio derived from AF pre-amp U4a (switch Q2 sets slow AGC decay for SSB reception). On transmit, processor control voltage is derived from PA level detector D9 (Q2 sets fast decay for syllabic processor).

Receiver product detector U3 demodulates incoming SSB signals (10 MHz LO is self generated by U3). U3's audio output feeds U4a, a preamp and active LP audio filter. U4a drives ACG detector D6/D7 (input to U4a is killed by switch Q5 during TX to disable the AGC path to U2). U4a also drives AF power amplifier U5 through the volume control. U5, which powers the speaker during RX, is gated into standby during TX to prevent residual feed through.

### TRANSMITTER:

Microphone speech amp U4b drives balance modulator U6 during TX (switch Q6 kills U4 output to prevent mic bleed through via U6/U2 during RX). LO for U6 is derived from U3's BFO oscillator. Q8 is used to unbalance U6 for carrier or CW generation. DSB output from U6 is routed to Y1 Y6 via switch D1/D2 for removal of LSB products and carrier artifacts. After undergoing dynamic compression in U2, the processed USB signal is routed to transmitter mixer U7 by switch D3/D4 where it is mixed with 4 MHz VFO (VFO signal is sampled from U1's oscillator and buffered by Q1). Bandpass filter L5-L6 selects the 14 MHz mixer product and feeds it to pre-driver Q9. Q9 feeds driver Q10. Q10 drives PA stage Q11. Q11 operates in single-ended class AB with bias generated by clamping diode D10. T5 matches PA output to a 50 Ohm system, and low pass filter L7-L8 suppresses harmonic content. Level detector D9 tracks the SSB speech envelope and generates feedback to Q3/Q4 and U2. Syllabic compression of the speech waveform optimizes average transmitter output power. The MFJ-9420 is especially designed to operate from lightweight constant current power sources such as NiCd cells or the MFJ wall adapter AC supply.

### SWITCHING AND REGULATION:

Q7 activates relay K1, which routes the antenna line and activates the +T and +R buses (+T and +R buses power some stages, key switch nodes, and bias Q11 on during TX). Adjustable regulator U8 sets Vcc for low-level stages. Fixed regulator U9 sets U1 operating voltage to ensure VFO stability. Crowbar diode D11 and a pc track fuse protect the radio from reverse polarity.

## MFJ-9420 CONTROL LOCATION AND FUNCTION

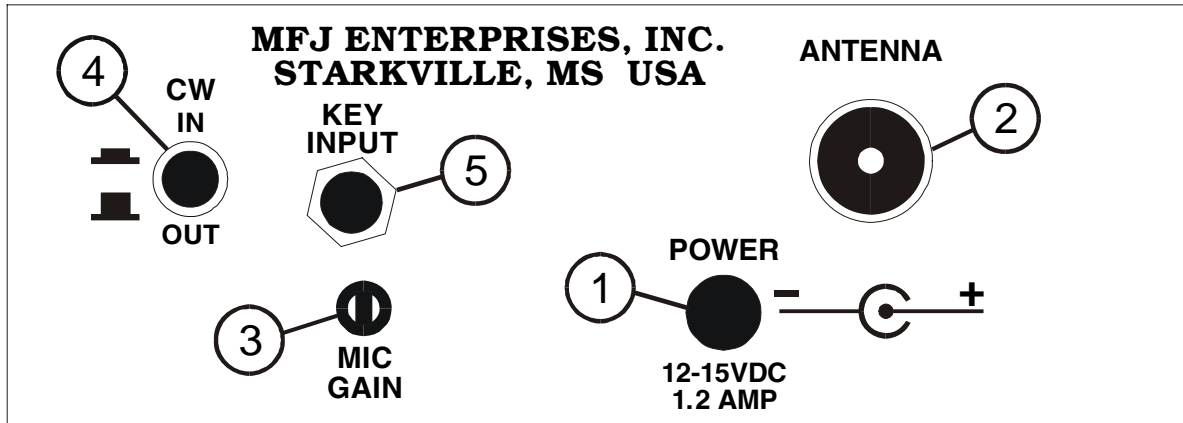

REAR PANEL

- |                  |  |
|------------------|--|
| 1. POWER JACK:   | 5.5mm OD, 2.1mm ID, (+) to center pin.       |
| 2. ANTENNA JACK: | SO 239 for standard coax plugs.              |
| 3. MIC GAIN:     | Sets Speech amp Gain (normal setting 12:00). |
| 4. CW ADAPT:     | Engages CW adapter (accessory).              |
| 5. KEY:          | Accepts straight key or keyer.               |

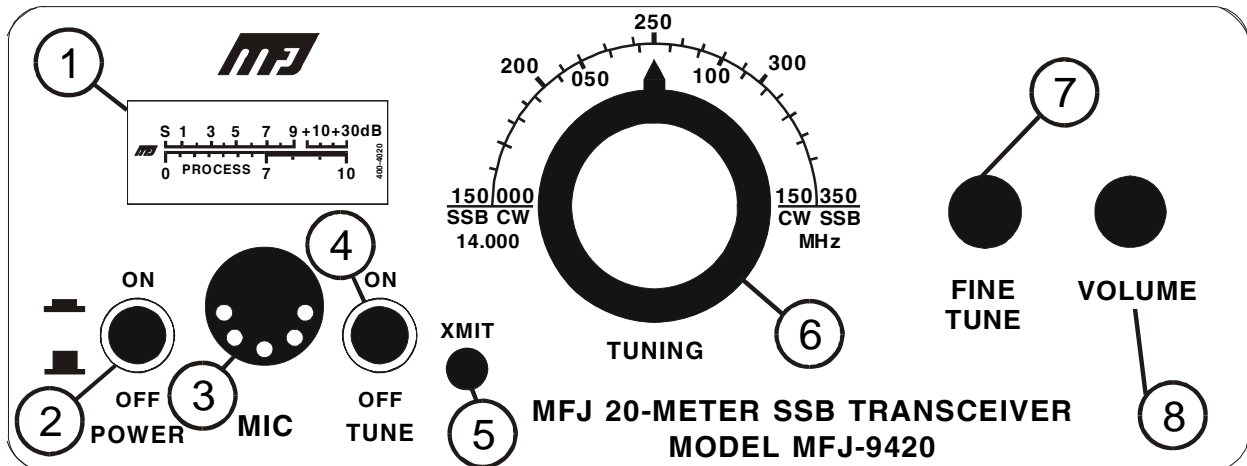

FRONT PANEL

- |                  |   |
|------------------|---|
| 1. METER:        | Show signal strength on RX, ALC on TX.      |
| 2. POWER SWITCH: | Turns power on to transceiver.              |
| 3. MIC:          | 5 Pin Din Jack for Dynamic Microphone.      |
| 4. TUNE:         | Injects carrier for ATU adjustments.        |
| 5. XMIT:         | LED illuminates when transmitting.          |
| 6. TUNING:       | Tunes in stations, indicates VFO frequency. |
| 7. FINE TUNE:    | Allows for fine tune adjustment.            |
| 8. VOLUME:       | Adjusts listening level.                    |

## SETTING UP YOUR MFJ-9420 PORTABLE STATION

To put your MFJ-9420 station in operation, you will need a power source, a 20-Meter antenna, and a microphone. Here are some specific suggestions to help you get started:

**POWER SOURCE: 12 15 V @ 2A (+) TO CENTER PIN**

The MFJ-4114 AC/DC PORTABLE POWER PACK and MFJ-4110 AC wall adapter supply are especially designed for your radio. However, you may use any filtered DC power source capable of delivering 12 15 volts at 2 Amps (13.8V required for full RF output). The DC power connector at the rear of your MFJ-9420 is a 5.5mm OD, 2.1mm ID coaxial type jack. Extra plugs are available from RadioShack stores (#274-1567). Always connect plus (+) to the CENTER PIN.

**MICROPHONE: USE 600 OHM DYNAMIC**

The MFJ-9420 speech circuit is designed especially for 600 Ohm dynamic microphones such as the MFJ-290 (the MFJ-290 is supplied if you purchase the MFJ-9420M package). You may also use other suitable 600 Ohm desk or hand mics by installing a 5 pin DIN plug (Radio Shack #274-003). See installation diagram below:

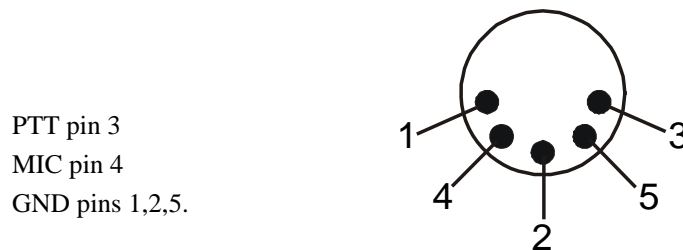

### **WARNING:**

**NEVER USE AN AMPLIFIED MICROPHONE WITH YOUR TRANSCEIVER.**

**The speech processor already has extremely high gain and may distort severely overdriven by a "power mic".**

**ANTENNA REQUIREMENTS: VSWR 3:1 OR LESS**

The MFJ-9420 accepts most 20-Meter antennas with a VSWR of 3:1 or less. Use your regular station antenna or a portable 20-Meter dipole such as the MFJ-1772 ultra light. For non-resonant wires, use a tuner such as the MFJ-971. Always "rough tune" for maximum receiver sensitivity first using incoming signals and your S-Meter to find a peak. AVOID OPERATING INTO UNMATCHED HIGH VSWR ANTENNAS. THE MFJ-9420 DOES NOT HAVE A HIGH VSWR SHUT DOWN CIRCUIT AND BADLY MISMATCHED LOADS COULD RESULT IN TRANSMITTER INSTABILITY AND GENERATION OF OUT OF BAND SIGNALS!

## **STEP-BY-STEP INSTRUCTIONS USING YOUR MFJ-9420 TRANSCEIVER**

- STEP 1. Connect a suitable microphone, power source, and 20-Meter antenna.
- STEP 2. Turn VOLUME fully counter clockwise (down) and press ON switch to power up radio. PWR indicator should light.
- STEP 3. Turn VOLUME clockwise for a comfortable listening level.
- STEP 4. If you are using an antenna tuner, adjust ATU controls for strongest received signals or maximum background noise on the S-Meter. Then, press CARRIER to generate a steady RF signal for final adjustment. Red XMIT indicator should light.
- STEP 5. The VFO tuning range covers 14.150-14.350 MHz and the MFJ-9420 tuning dial was carefully calibrated at the factory. However, by nature an analog frequency readout may be subject to some inaccuracy or misinterpretation. To ensure compliance with FCC rules, we suggest the following:
- (a.) Periodically check the VFO dial with a digital transceiver or counter to confirm location of band edges.
  - (b.) Avoid transmitting on the margins of your allocation unless you are certain the station you are calling is in "in band."
- STEP 6. To transmit, press the mic's PTT switch and speak at normal conversational level with the mic held about 2 inches from your mouth. The MFJ-9420 has a very potent speech processor and will pick up your voice at full intensity. Avoid the natural temptation to yell or close talk this will only overload the processing circuit and hurt the intelligibility of your signal!

### **SPECIAL OPERATING NOTES**

The MFJ-9420 does not have automatic high VSWR shutdown and you must provide a "reasonable" 20-Meter antenna to ensure proper operation. Whenever possible, use a low SWR resonant type antenna such as a dipole or tuned vertical. If you use an ATU (or a high Q loop such as the MFJ-1786 or Isopole 10 30), carefully rough tune first for maximum S-Meter readings before activating the CARRIER switch.

Under FCC Rules, licensed amateurs are solely responsible for the frequency of operation of their transmitters. MFJ cannot be held responsible for out of band operation due to misinterpretation or miscalibration of the MFJ-9420 analog VFO dial.

### SIMPLE 20-METER ANTENNA SUGGESTIONS

COAXIAL FED DIPOLES: A wire dipole for the phone band should measure about 32'10" (16'5" per leg). Feed with RG-58U or RG-8X; raise high and in the clear for best performance. If you have only one high support, make an inverted V. The "full sloper" (sloping dipole) is also an excellent single support antenna with some directivity.

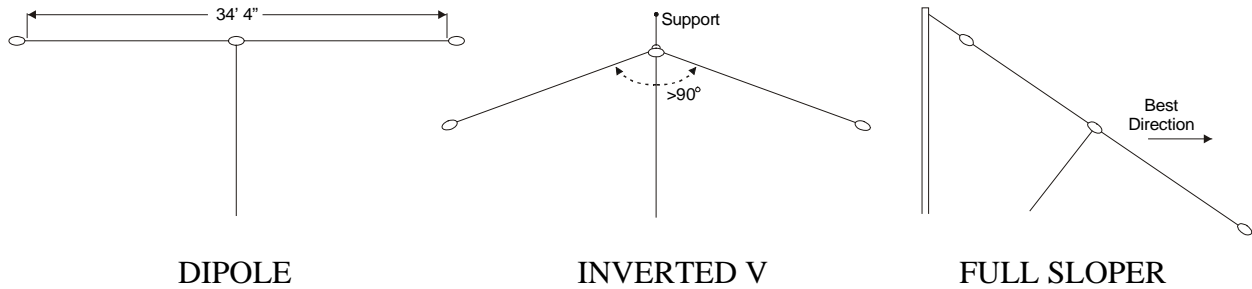

MFJ-1772 PORTABLE DIPOLE: As an alternative to making a coax-fed dipole, consider purchasing the pre assembled MFJ-1772 antenna. This is a no compromise 20-Meter folded dipole complete with 30' of feedline all made from ultra lightweight 300 Ohm twinlead. Connect a random length of coax from the MFJ-1772 feedline to your rig and let the antenna's built in 50 Ohm matching network do the rest. The antenna is pre tuned, easy to handle, and sufficiently broad banded to cover both the CW and phone band.

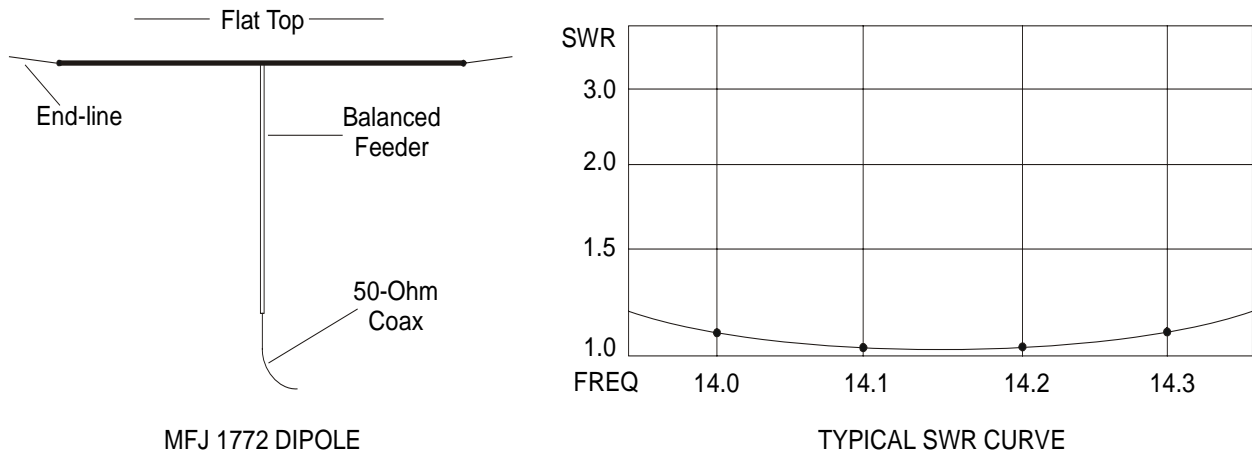

**WARNING: CONSTRUCTING OR ERECTING AMATEUR RADIO ANTENNAS IN LOCATIONS WHERE THEY MAY COME INTO CONTACT WITH ELECTRICAL POWERLINES MAY RESULT IN ACCIDENTAL INJURY OR DEATH!**



## GETTING THE MOST FROM YOUR MFJ-9420 STATION:

While spanning the globe with a small portable rig like the MFJ-9420 may SOUND difficult, it really is not. High power and big antennas have never been a requirement for worldwide radio communication and still are not. Despite the vast distances involved, hams consistently reach every corner of the planet running far less power than your MFJ-9420. How do they do it? Here are some proven tips guaranteed to work:

### GROOM YOUR ANTENNA

Inspect and clean all traps and contacting surfaces. Replace corroded hardware, dirty connectors, and aging coax. Retune for minimum SWR in the phone band.

Raise wire dipoles high and in the clear 40 to 60 feet is far better than 10 or 20. Carefully prune for minimum SWR. If you have only one high support, install an inverted V or sloper.

Multiband verticals (1/4 wave types) require at least 4 good 14 MHz radials add them if needed. Clean up corrosion and adjust your top section for minimum SWR in the phone band.

Avoid "compromise" antennas. When it comes to pure operating enjoyment, every dB you gain at the antenna pays big dividends!

### USE PROVEN DX OPERATING TECHNIQUES

Be a good listener and search out and answer CQs, or call stations that have just completed QSOs (a practice called tailgating).

Never hesitate to call a weak station because it may be QRP or using a marginal antenna. You may be much louder than you think!

Be realistic about diving into huge 20-Meter pileups. Once a choice DX station hits the packet clusters and the big guns move in, calling may be a waste of time until the smoke clears.

Tune slowly and listen carefully. If one exotic station is coming through, there may be others you can work nearby.

Pay attention to DX forecasts and gray line propagation. When the band is hot, power differences become much less significant. Operating just before the band goes out at night may yield strong signal reports from exotic locations with little QRM.

Do not be shy about calling. The MFJ-9420 has very potent audio and on air tests indicate its signal is competitive with higher-powered radios. If your antenna is good, most stations will not even know you are running low power!

## TROUBLESHOOTING

IN CASE OF TROUBLE, CHECK IT OUT FIRST – THEN CALL US AT 800-647-TECH (800-647-8324): Your MFJ-9420 is fully backed for 1 year by MFJ's "NO MATTER WHAT GUARANTEE". After that, MFJ Customer Service Technicians will be there to help you keep your rig in top shape for as long as you own it. However, before you call us, please check through this list just to make sure the problem is not something simple you can fix yourself!

### 1. RADIO DOES NOT POWER UP

- Is power plug okay, broken supply wire?
- Is supply or battery functional?
- Is reverse polarity fuse open?

**2. NO SIGNALS RECEIVED**

- Is antenna disconnected or broken?
- Is TUNE switch stuck on?
- Is the band dead?

**3. RADIO DOES NOT TRANSMIT OR KEYS ERRATICALLY**

- Is microphone and connector okay?

**4. ERRATIC TRANSMIT**

- Is SWR high (above 3:1)?
- Is power source voltage low or "soft" under load?

**5. AGC IS INEFFECTIVE OR S-METER IS NOT ZEROED**

- Is Regulator okay (10.0 V on TP1)?
- Is AGC okay (4.3 on TP2)?
- If TP1, TP2 is okay and AGC works, rezero meter via R51.

**6. RADIO DRIFTS IN FREQUENCY**

- Is radio sitting in Sun, on hot surface, in cold draft?
- Was radio moved from extreme cold to warm (condensation)?
- If you suspect condensation, allow radio to fully dry out.

**7. POOR CARRIER SUPPRESSION**

- Was radio moved from extreme cold to warm (condensation)?
- Was radio exposed to rough handling or shock?
- To null, unplug mic and ground pin 3 to key radio. Adjust R36 and T3 for minimum carrier (monitor using a second receiver).

**8. LOW TRANSMIT AUDIO:**

- Is the mic a 600 ohm dynamic type?
- Is the MIC GAIN set too low?

**9. NOISE ON TRANSMIT AUDIO:**

- Is MIC GAIN set too high in a noisy room?
- Is mic next to a power transformer or motor?

If these checks don't uncover the problem, or if you do not feel qualified to make the prescribed adjustments, please call us for help at 800-647-TECH (800-647-8324).

**FIELD ALIGNMENT PROCEDURES FOR THE MFJ-9420 TRANSCEIVER****SPECIAL TOOLS, PARTS, TEST EQUIPMENT:**

- AC Power Supply, 13.8 Volts @ 2 Amps
- Voltmeter
- Non-inductive Alignment Tool kit
- Frequency Counter
- Wattmeter with 50 Ohm Resistive Dummy Load
- 14 MHZ Signal Generator or other weak signal source
- General Coverage Receiver with digital readout

**INITIAL TEST SET UP:**

- A. Remove transceiver cover.
- B. Connect 13.8 Volts Power Supply to Power Jack.

- C. Connect Microphone.
- D. Turn on unit.

**VOLTAGE CHECKS AND ADJUSTMENTS:** (use voltmeter)

- A. **VOLTAGE REGULATOR:** Set R64 for 10.0 V at TP1.
- B. **RECEIVER AGC:** Set R6 for 4.3 Volts at TP2.

**VFO CALIBRATION:**

- A. Tune the VFO dial to 14.250 MHz (mid band).
- B. Connect counter probe to U7 pin 6
- C. Adjust L3 for 4.255 MHz readout.

**BFO FREQUENCY CHECK AND ALIGNMENT:**

- A. Tune across 14.250 MHz. test signal (use generator).
- B. Identify 2 peaks in passband by watching S-Meter.
- C. Carefully set the VFO dial to lower frequency response peak.
- D. Adjust BFO trimcap (C61) until CW note is 600 Hz.
- E. Recheck. First peak should be at 600 Hz, second peak around 2000 Hz. Pitch of CW tones should go DOWN as you tune UP in frequency, indicating USB operation.

**CARRIER NULL:** (use a second receiver to monitor beat note)

- A. Short mic pin 4 to ground to kill mic pickup.
- B. Key mic and monitor signal slightly off frequency.
- C. Alternately adjust R36 and T3 for minimum carrier.

**RECEIVER SENSITIVITY CHECK:**

- A. Connect weak 14.250 MHz signal source to antenna jack.
- B. Tune in signal source for maximum S-Meter reading.
- C. Touch up L1, L2, T1, and T2 for max SIG Meter reading.

**TRANSMITTER BANDPASS FILTER AND COMPRESSOR ALIGNMENT:**

- A. Connect QRP Wattmeter with dummy load to ANT Jack.
- B. Turn R61 fully CW and then the Press Carrier Switch (SW2).
- C. Carefully touch up L5 and L6 for peak output.
- D. Turn R61 CCW until RF output power drops by 10%.

If radio fails to operate properly after following these procedures, call 800 647 8324 for help.

\*If reverse polarity track fuse opens, install a miniature 2.5 A pigtail fuse or a 3/4" hair pin loop of #32 wire.

**DC VOLTAGE CHART TROUBLESHOOTING GUIDE**

For advanced troubleshooters, the following are typical DC voltages found in the MFJ-9420. Voltages were checked with handheld probe type DVM to minimize effects of lead inductance and to limit the potential for RF feedback.

- Vcc = 13.8 (Supply Voltage)
- TP1 = 10.0 (LM-317 Output)
- TP2 = 4.3 (AGC Bias Voltage)

**INTEGRATED CIRCUITS:** (TX checks made with mic. keyed, no audio)

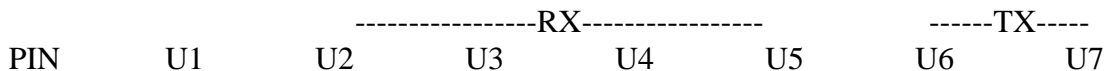

1	1.4	10.0	1.4	5.0	9.9	1.3	1.4
2	1.4	10.0	1.4	5.0	2.5	1.3	1.4
3	0	0	0	5.0	0	0	0
4	3.9	3.3	4.0	0	2.9	4.9	4.7
5	3.9	4.9	4.0	5.0	4.9	4.9	4.7
6	4.9	3.3	5.0	5.0	0	5.7	5.8
7	4.5	0	4.6	5.0	0	4.9	5.2
8	5.0	10.0	5.1	9.9	4.9	4.9	5.8

## BIPOLAR AND JFET DEVICES:

D/E = Drain/Emitter

S/B = Source/Base

G/C = Gate/Collector

\* = Test in TRANSMIT mode

\*\* = Test with TUNE switch depressed

\*\*\* = DO NOT TEST gate of Q9 may cause generation of parasitic oscillations.

	Q1	Q2	Q3	Q4	Q5*	Q6	Q7*	Q8**	Q9	Q10
D/E	9.8	0	9.0	9.7	0	0	3.5	0	13.0	0.25
S/B	2.3	0.7	3.9	8.9	0.7	0.7	2.8	0	0	1.0
G/C	0	13.2	0	4.3	13.0	0	0	9.0	***	13.7

Q11 (MRF477 PA Transistor): To avoid RF damage to DVM, check collector voltage in receive mode only full supply voltage (13.8 V) should be present. Check base (bias) with PTT pressed, no audio this should indicate 0.6v. Emitter is grounded.

# SCHEMATIC

