



Built-in automatic antenna tuner ATU

Portable SDR HF Transceiver

G90

Operation manual



XIEGUTECH

V1.00.01

Catalog

Basic Feature	2	Pre-channel naming TAG	30
Panel button	3	Boot interface call sign setting CALL	31
Front panel Interface	6	Connect to a computer for data communication	32
Tail interface	7	System parameter setting	33
Interface definition	8	Computer control instruction	33
MIC button	9	Bands voltage parameter	33
External power connection method	10	Performance parameter	34
Menu operation	12	Packing items	35
Display interface	12	G90 and XPA125B connection diagram	36
Power on/off	13	CE-19 expansion card interface	37
Operating frequency bands selection	14		
Operating MODE selection	15		
Volume adjustment	16		
Multifunction adjustment knob	17		
Adjusting transmit power Po	18		
Setting operation frequency	19		
ATU	20		
Function buttons	21		
Setting SPL and VFO	23		
CW transmission	24		
CW Auto pager	25		
Standing wave scanner SWR	26		
Digital filter	27		
Line Input / Output selection	28		
Channel Memory MW	29		

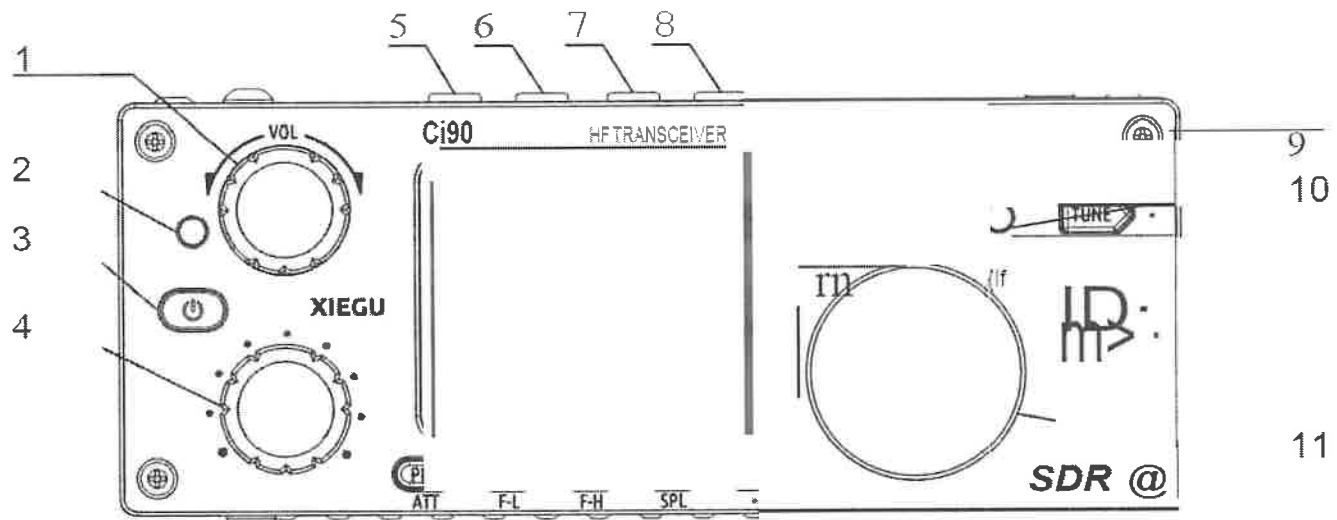

-
- | | |
|--|---|
| <p>1 Volume knob</p> <ul style="list-style-type: none"> ● Turning, + /- the volume. ● Short press, Switch to headphone output mode. <p>2 Power/ Receive or transmitting status pilot lamp.</p> <ul style="list-style-type: none"> ● Standby/receive status, showing yellow-green; ● transmitting status, showing red; <p>3 Power switch</p> <ul style="list-style-type: none"> ● In the off state, press it to boot. ● In the on state, hold press it to shut down. <p>4 Multifunction adjustment Knob</p> <ul style="list-style-type: none"> ● By default, turning this knob will stepping at 100 kHz. ● Press and hold this knob to switch to the Select Custom function. <p>5-6 Mode switching
Mode switching</p> <p>7-8 BAND Switching
Band switching</p> <p>9 FUNC pilot
This pilot will light when the second function of the button is operated.</p> | <p>10 △F Pilot</p> <p>11 Main Knob
Operating this knob will change the current frequency.</p> |
|--|---|

Panel button

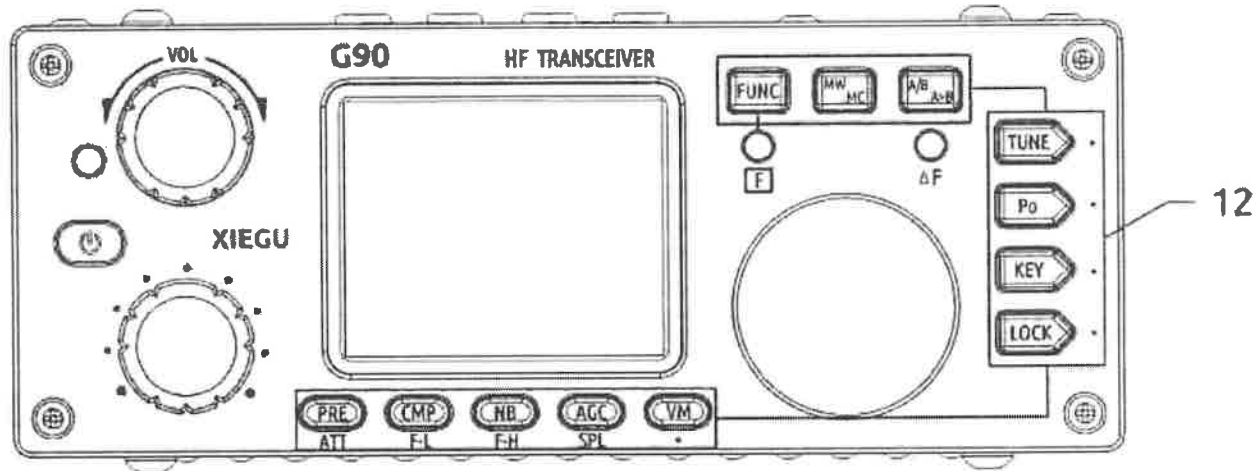

12 Function button

Button definitions and functions are detailed in the operation section.

Machine Head Interface

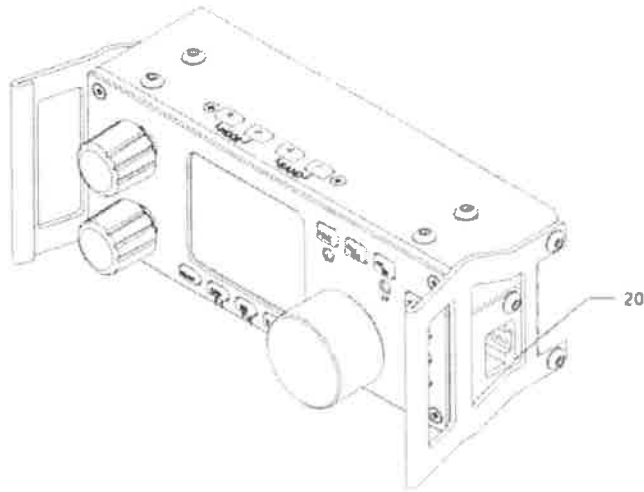

- 20 MIC Interface** (On the right side of the machine-head)
Connecting the multi-function MIC to this connector.

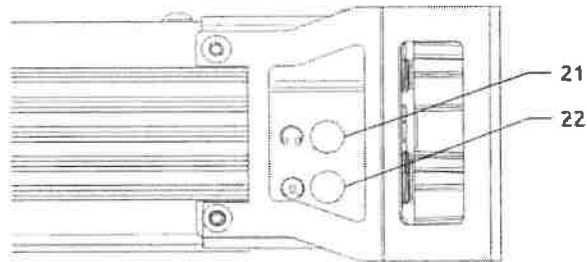

- 21 headphone interface** (On the left side of the machine-head)
This 3.5mm stereo jack (3-pin) for connecting headphones.
- 22 Self-defining (communication) interface** (On the left side of the machine-head)
Firmware update for the machine-head (Controller), or other features.

Tail plate interface

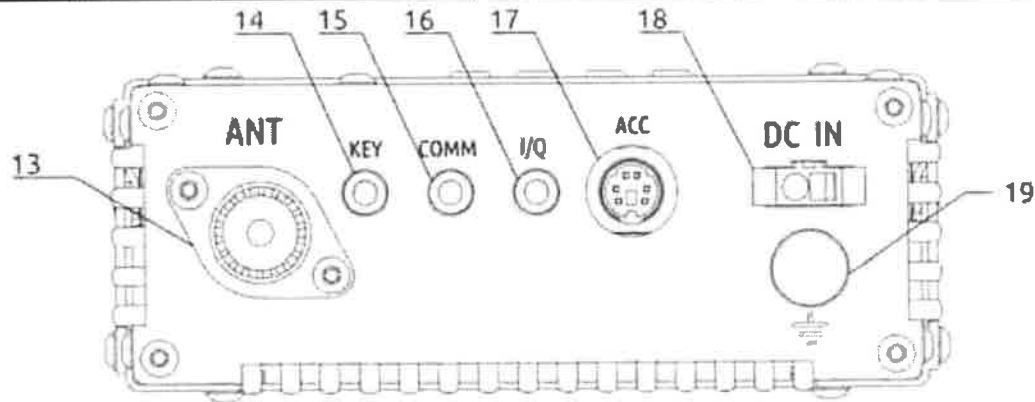

13 Antenna interface

SL16-K type, impedance 50Ω.

14 KEY interface

The interface is a 3.5mm stereo jack for connection to manual/automatic telegraph keys.

Telegraph key connection diagram, as shown:

Manual telegraph keys, It is Necessary to connect "di(滴)" And "da (嗒)" together.

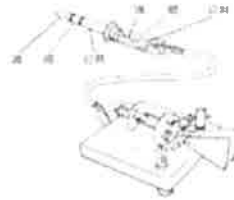

15 COMM interface

Using for the case firmware updates.

16 I/Q Signal output

The interface is a 3.5mm stereo jack for "I/Q" signal output.

17 ACC

The interface is an 8-pin mini DIN interface, as defined in the interface definition.

18 DC power interface

External DC power input interface.

The round hole is "-", the square hole is "+".

19 Ground terminal

Interface Definition

1 · MIC interface

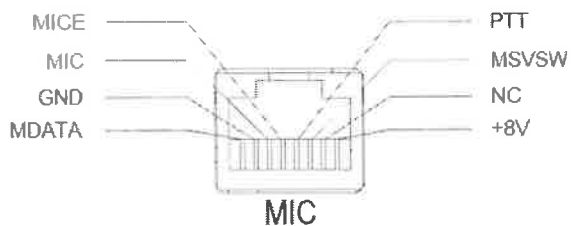

4 · ACC interface

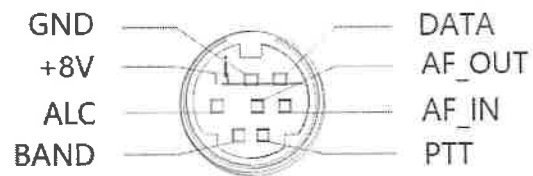

2 · COMM Connector

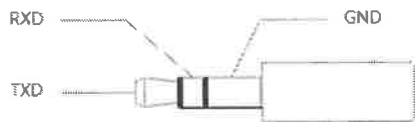

5 · Telegraph key wiring diagram

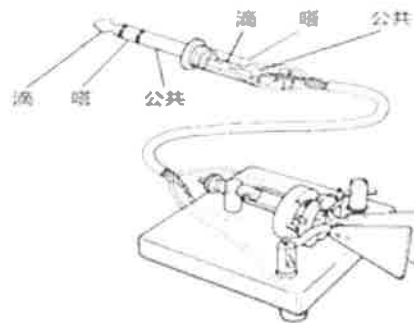

3 · Headphone interface



Note: 滴 (di) 嗒 (da) 公共 (common)

Hand MIC

- | | |
|-------------------------------|--|
| 1、 LOCK | Lock button |
| 2、 PTT | Transmit control button |
| 3、 UP/DOWN | Frequency "+" or "-" buttons |
| 4、 Receive/transmit indicator | Hand Mic operation indicator |
| 5、 Numeric keypad | Numeric keypad area |
| 6、 FIL | Filter selection |
| 7、 MODE | Case operation mode |
| 8、 Function indicator | No |
| 9、 Function button | F1/F2 self-defining setting button |
| 10、 MW | Storage operation |
| 11、 V/M | Frequency/channel switching |
| 12、 XFC | No |
| 13、 TUNER | Hold press to turn on the built-in automatic antenna tuner for tuning. |

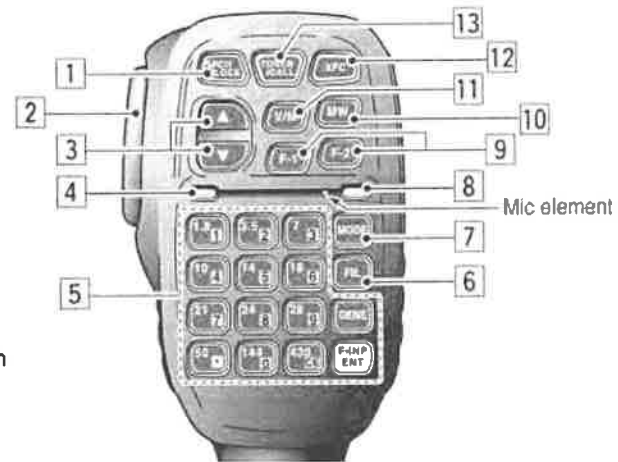

External power connection

The G90 can use a 13.8V external DC power supply. The DC power supply has a current load capacity of at least 10A. The supplied power cord can be used to connect radio and DC power.

When connecting the DC power supply, please carefully connect according to the following figure to avoid reverse polarity of the power supply.

The red wire is connected to the positive pole of the power supply, and the black wire is connected to the negative pole of the power supply.

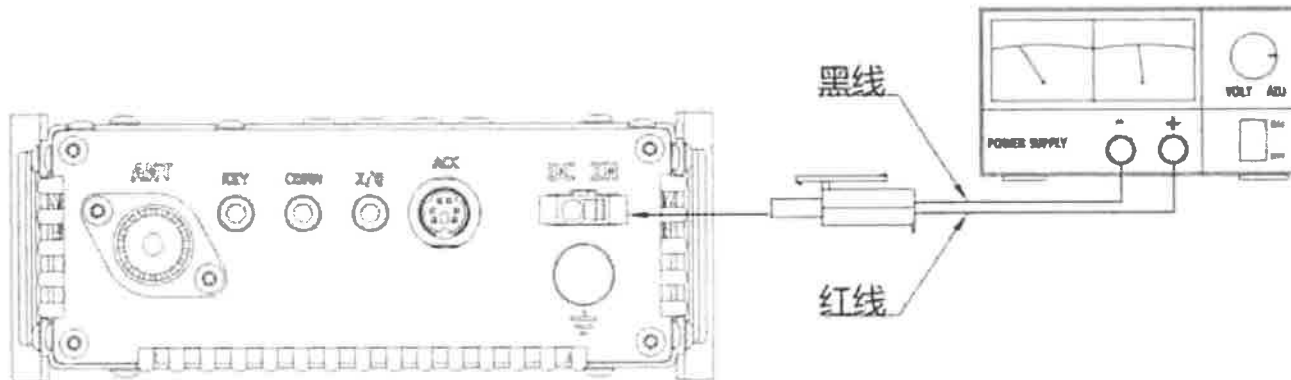

Note: 黑线 (black wire) 红线 (red wire) ;

Operating

When the G90 uses an external power supply, in order to prevent external interference from entering the radio through the power line or the radio frequency interference in the radio is radiated outside through the power line, we can put the EMC magnetic ring on the power line. Install the magnetic ring as close as possible to the side of the power plug.

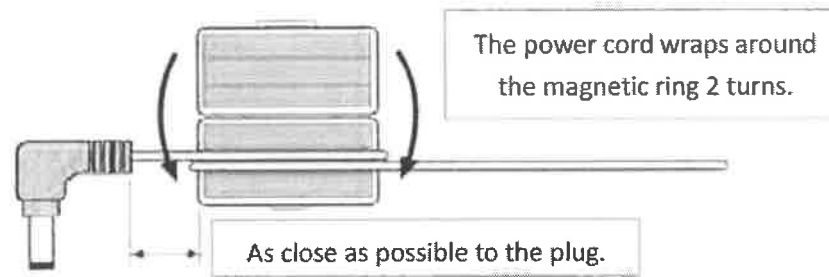

- When using an external power supply, carefully check the polarity of the power cord and do not reverse the polarity.
- The limited warranty of this radio does not include damage caused by an external power connection error or damage caused by improper power supply voltage.

Machine-Head Interface

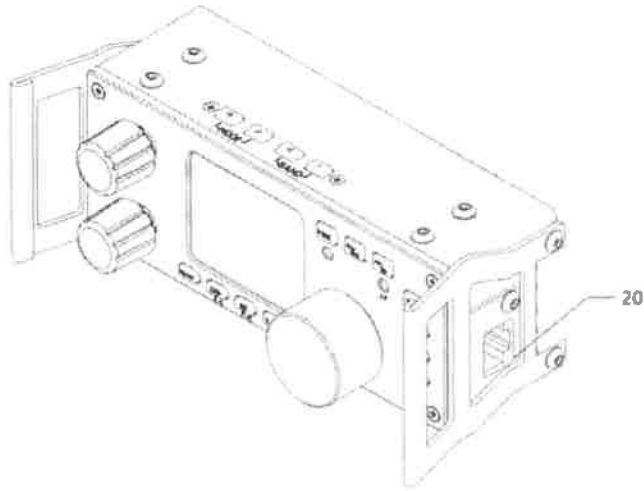

- 20 MIC interface** (On the right side of the machine-head)
Connecting the multi-function MIC to this connector.

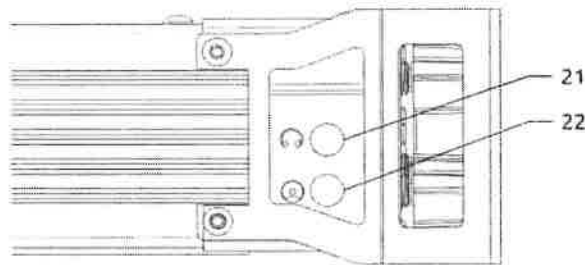

- 21 headphone interface** (On the left side of the machine-head)
This 3.5mm stereo jack (3-pin) for connecting headphones.
- 22 Self-defining (communication) interface** (On the left side of the machine-head)
Firmware update for the machine-head (Controller), or other features.

External power connection

The G90 uses the Quick Mode button operation to use or turn off various functions. All functions are distributed on each function button (or in the second function). All functions are turned on or off or adjusted and displayed or reminded in the corresponding area on the screen.

Interface display as follows:

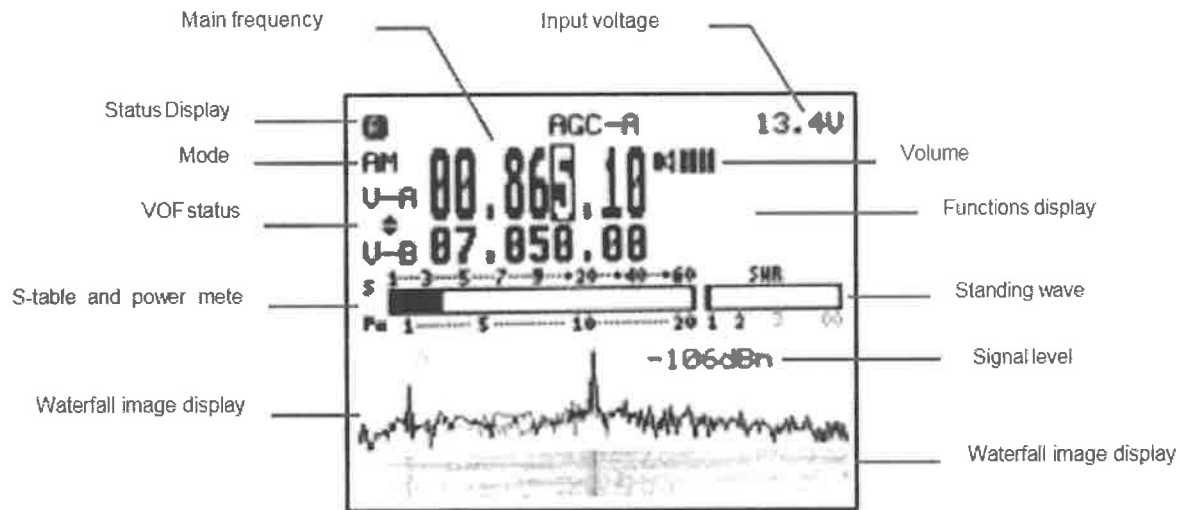



Operating

Hi Dear friends.

In order to let you master the functions and proficiency of the G90 portable transceiver ASAP, please read the operation guide of this manual to understand the powerful functions of the G90. Go ahead now!

Turn on/off Transceiver

- 1、Turn on: press  button.
- 2、Turn off: Power on state, Hold press  button 1 second.

Turn off screen operation:

In the power on state, tapping the switching Button to turn off the screen display.

The other units are still working.

Pressing any button or turning the Knob will wake up the screen display.

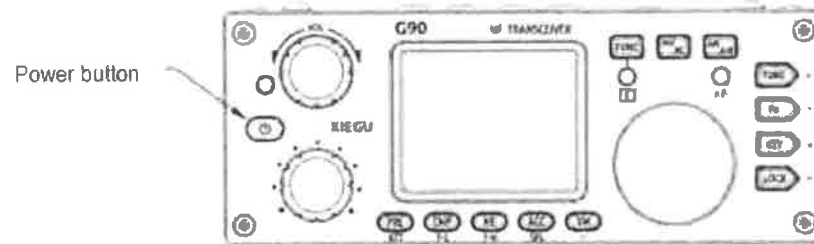

Operating

Operating frequency band selection

The G90's frequency range covers 0.5 to 30 MHz. Amateur frequencies within this range are divided into multiple bands, and band switching can be performed in a number of different ways.

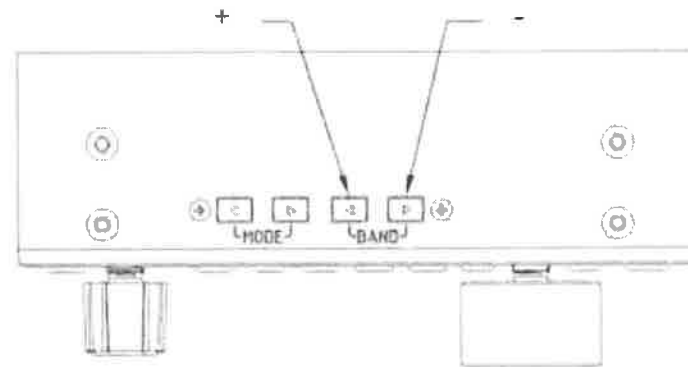

Operation method:

Press the BAND's < or > button, Switch to the next or previous operating band separately.

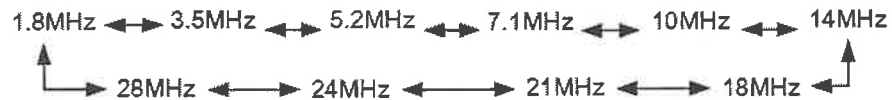

- Each amateur band has a user-defined frequency band that can be used temporarily, when the band is switched, you will see this custom band.
- Whether the 60-meter band is open, it depends on the different laws of different countries (or regions).
- Different versions of the machine have different frequency divisions, depending on the laws of different countries (or regions).
- VFO-A and VFO-B are two independent VFO modes that can be set to different operating states. Check [VFO Settings] please.

Operating mode select

Press [**MODE**] button, In all modes , according to the following fixed order switching

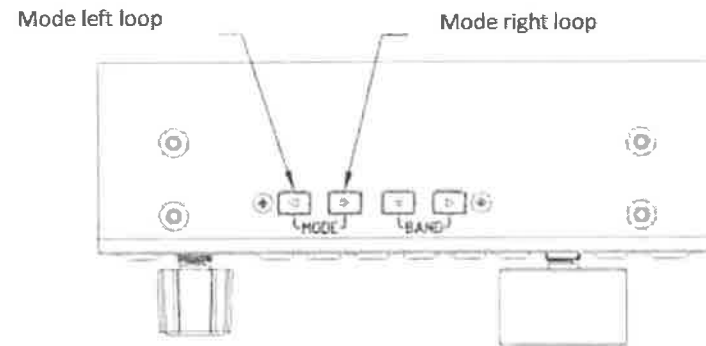

- ◆ *The FM mode can only be turned on when used with the GSOC controller.*

VOLUME CONTROL

Speaker mode:

Rotate the volume knob left or right to adjust the size of the output volume.

Headphone mode:

- > Press the volume knob short to enter headphone mode.
- > Rotate the volume knob left or right to adjust the size of the headset volume.

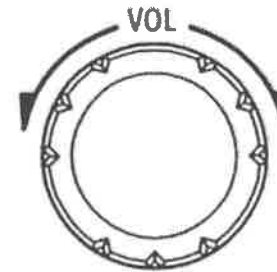

VOX mode on/off:

Press and hold the volume knob for 3-second to turn the VOX feature on or off.
(This feature has not been activated yet.)

- When using the AF in/out Port of the ACC interface, set the relevant volume size in the system menu.

Multifunction adjustment knob

The multifunction knob provides several operation options and can customize features.

Operation method:

Default: Stepping of 100 kHz frequency bits.

Multi-function adjustment

Short press: Enter SQL item to adjust SQL noise depth.

Hold press: Go to the User Custom feature menu, rotate

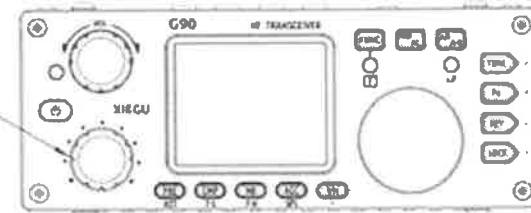

The main knob to select the appropriate function, and short press the "SAVE" key to determine that the feature is selected.

At this point, the feature is projected onto the [multifunction adjustment knob].

The customizable features are as follows:

- 1) Frequency 100k, stepping 100k
- 2) SQL Level, squelch setting
- 3) Po Level, transmit power setting
- 4) Key Speed, automatic key rate setting
- 5) FFT Scale, spectrum reference level setting

Adjustment transmitting Po

Operation method:

1. Short press the [Po] button to enter the power setting state, the right side of the screen function display area will display the power settings number.
2. Rotate [multifunction adjustment knob] for power setting with stepping 1W.

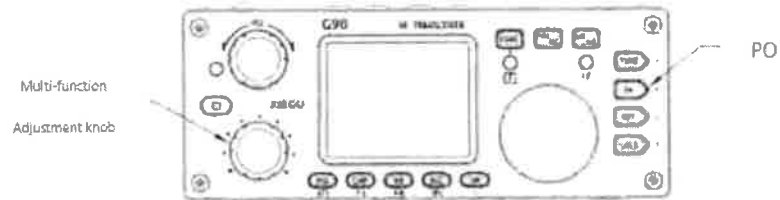

- ◆ *When using the G90 transceiver for the first time without understanding the current antenna state, minimize the set transmit power value.*

Set the operating frequency

There are two ways to set the G90 operating frequency, which is to use the main knob and multifunction handle to set the frequency.

Operating method:

1. Set the frequency using the main knob

- Short press the main knob, select 100Hz, 1kHz, 10kHz Stepper.
- Rotate the main knob to set the frequency of the current step.

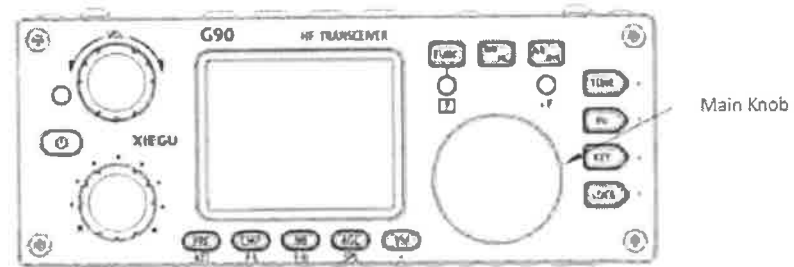

2. Set the frequency using the multifunction handle

- Press the [F-INP ENT] button on the handle. G90 enter the frequency setting state, the cursor will blink in the first position on the left side of the frequency display bit;
- Enter the frequency values you want to set, and then press the [F-INP ENT] button again to complete the frequency setting.

For example, set the current frequency to 14.09000MHz, and the key order is as follows:

1. First press the [F-INP ENT] button;
2. Press the number key in sequence;
3. Press the [F-INP ENT] button again, complete the setup.

Operating

Automatic Antenna Tuner

This G90 is integrated with an efficient automatic antenna tuner that can help you quickly set up and debug your antenna.

- Short press the [TUNE] button, will be connected to the built-in antenna tuner, the "TUNE" logo will be displayed at the top of the screen.
- When connected to the automatic antenna regulator, press the [TUNE] button for 1 seconds and the ATU auto-tuning function will be activated.

The receive status is automatically returned when tuning is complete.

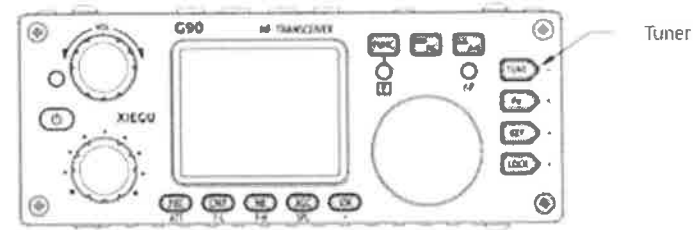

Note :

1. Press the [TUNE] button and the antenna icon appears at the top of the screen to indicate that the automatic antenna tuner function is turned on. Just open, the automatic Antenna tuner tuning has not been started.
2. To use the built-in automatic antenna tuner, you must tune once after you turn on the Automatic Antenna tuner feature.
3. If you start the transmission after tuning, the "SWR" icon will appear on the top of the screen and flash, which means That the standing wave of the current antenna is still large and needs to be retuned.
4. When the antenna naturally resonates into the current band, be sure to turn off the Automatic Antenna tuner feature.
5. When using a whip antenna and turning on the built-in antenna tuner for tuning, it is possible to cause strong RF interference to the native or electronic device.

Function button

Its common functions are distributed on the various function keys. Some function keys have a second function.

When the function is selected, turn the main knob to adjust the value.

Operation of the second function:

- Press the [FUNC] button at first, the "F" indicator will light, then press the corresponding function button.
- Press the [FUNC] button again to exit the second function. At this time, the "F" indicator is off.



- In any function (including the second function of FUNC), press the main knob to exit the function settings and return to the main interface.

Operating

Button function table

Button	Func1 (press, cycle)	Func2 (FUNC+)	Hold press
PRE/ATT	PRE--ATT-- direct connection		/
CMP/F-L	Turn on transmit voice compression	Digital filter F-L low-end frequency selection	/
NB/F-H	Turn on pulse interference canceller	Digital filter F-H high-end frequency selection	/
AGC/SPL	AGC--、AGC-S、AGC-F、AGC-A cycle	Turn on split frequency transceiver operation mode	/
VM	Switch frequency mode or channel mode	<i>To be determined</i>	/
MW/MC	Turn on channel storage	Turn on channel clear mode	/
A/B A>B	Switch between VFO-A and VFO-B	Copy the current VFO to the background VFO	/
TUNE	Turn on/off the antenna tuning function	/	Start antenna tuner tuning
POW	POWER Transmit power setting	MIC GAIN MIC gain setting	/
	SWR THR Standing wave protection threshold	INPUT Voice input selection	/
KEY	SPEED Automatic key rate setting	CW Volume Side-tone volume setting	/
	M/L/R Manual/automatic left and right mode switching	CW TONE Side-tone frequency setting	/
	MODE iambic A/B Mode switching	/	/
	QSK Insert/not insert selection	/	/
	QSK Time Insert time setting	/	/
LOCK	5-level screen backlight brightness setting	SCALE Spectrum reference level setting	Lock button, knob

Operating

Split frequency transceiving operation SPL and VFOA/B settings

There are two independent VFOs inside the G90 transceiver. We can set different frequencies and modes separately. With the SPL function, it is convenient to realize the split transceiving operation.

VFO setting:

- 1、 Press the [A/B / A>B] button to switch between VFO-A and VFO-B.
- 2、 When switching to a certain VFO state, you can set the current VFO's operating frequency, mode and other settings.

Split frequency transceiver SPL operation method:

- 1、 Set the receiving frequency and mode (VFO-A) first;
 - 2、 Then setting the transmit frequency and mode (VFO-B);
 - 3、 Operate the second function of the [AGC/SPL] button,
 - 4、 Turning on the SPL function to turns on the split transceiver mode.
- ◆ You can make full use of VFOA/B to set different frequencies or modes, and switch between two frequency points in real time.

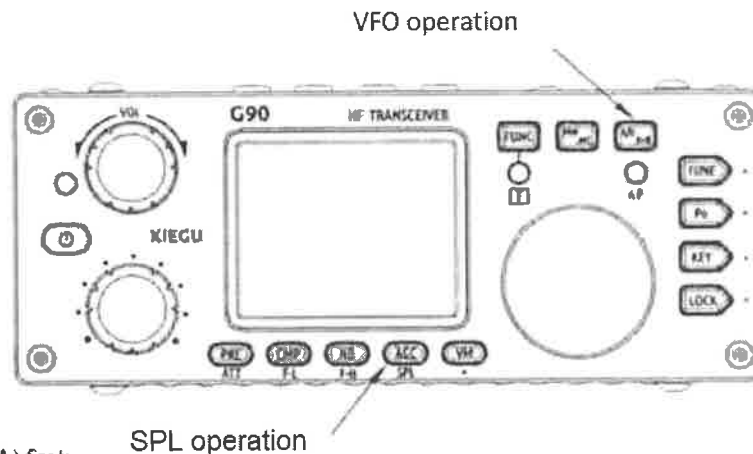

Operating

CW automatic caller MSG1~MSG3 (Not yet opened, need to be used with GSOC controller)

The G90 host provides 4 sets of CW preset telegraph text storage for automatic call in CW mode.

Operation method:

To be determined

Operating

Standing wave scanner SWR (Not yet opened)

G90 host has an antenna standing wave scanning function, which can scan the standing wave parameters of the current antenna, and is convenient for the user to adjust the antenna.

Operation method :

- 1、 Operate the second function of the [Po] button to start the standing wave scan;
- 2、 After the scan is completed, the scanning process is automatically exited.

◆ *The scanning result of the standing wave scanner may have a certain error, for temporary use only. For accurate measurement of antenna standing wave data, use a professional antenna analysis device for measurement.*

Digital filter

The G90 has a built-in variable digital filter that implements a narrowband filter function to improve signal identification.

Operation method:

- ◆ Operate the [CMP/F-L] button and the second function of the [NB/F-H] button;
- ◆ Rotate the main knob to adjust the lower limit of the digital filter frequency and the upper limit of the frequency respectively until the user experience is appropriate;

- ◆ *You can adjust the filter parameters according to your own listening preferences to get the best experience.*

Line input/output

The G90 has an external line input interface. When communicating with a computer or an external modem for data communication, the corresponding input/output items should be correctly selected.

Operating method:

- ◆ In the system menu, using ACC port line input, select: AUX LINE IN. Set the appropriate input volume.
- ◆ In the system menu, select: AUXAFOUT VOLUM to set the appropriate output volume.

- ◆ *When digital communication is in progress and audio input is made using the ACC port, make sure that the volume of the line input is sufficient.*

Channel storage MW, clear MC

Channel storage:

1. In the VFO mode, adjust the required frequency, mode, advanced function status and other parameters;
2. Press the [MW/MC] button to start the channel storage operation;
3. Rotate the main knob to select the channel number to be stored, and short press the main knob to complete the channel storage;
4. If the current channel has stored information, using this channel number for storage again will clear the previous channel information and save the current channel information.

Bring up the storage channel:

1. If you press the [VM] button on the panel in VFO mode, you will enter channel mode;
2. Rotate the main knob to switch the current channel.

Clearing channel storage:

1. In the channel mode, operate the second function of the [MW/MC] button to start the channel clear function;
2. At this point, the channel number starts to flash. Rotate the main knob to the corresponding channel number and press the main knob to complete the channel clear.

Operating

Channel naming TAG (need to be used with GSOC large screen controller)

Stored channels can be named with "tags" consisting of letters and numbers.

Operating method:

To be determined.

Boot interface call sign setting CSN

The G90 can set the call sign information displayed on the boot interface.

Operating method:

1. Press and hold the [FUNC] button to go to the system setup menu and select the [CALL SIGN] function to go to the call sign editor;
2. Under the editor, after editing the call sign, save the set text content and return to the normal operation state;
4. When you turn it on again, the boot interface will display the call sign you edited.

Connect to a computer for amateur radio data communication

The G90 transceiver can be connected to a computer to perform various data communication with the corresponding computer software.

Operation connection method:

- ◆ Connect the computer audio output/input to the G90 from the ACC port (MINI-DIN8).
 - ◆ Insert the data cable into the COMM port, connect the G90 to the computer, and ensure that the computer driver of the data cable is installed correctly. The PC software can control the G90 transceiver;
 - ◆ Adjust the volume of G90 and the input/output volume of ACC port to the appropriate one. Observe the software interface to avoid the Audio frequency amplitude being too large and unable to communicate.
 - ◆ Select the corresponding working mode to perform data communication.
-
- ◆ **In order to prevent interference, the radio and computer must be well grounded. Please install the EMC magnetic ring for the data cable and audio cable, and install it as close as possible to the radio.**

Computer control instruction

The G90 uses the standard CIV instruction set. You can use the standard instructions of this instruction set to remotely control the transceiver. It can also be used to configure the control instructions of other software to control the G90.

Band voltage data

The G90's ACC port provides band data for each band. The band data can control the peripheral to automatically switch the band or share the band information with other devices.

Band	Voltage	Band	Voltage	Band	Voltage	Band	Voltage
1.8MHz	230mV	7MHz	920mV	18MHz	1610mV	28MHz	2300mV
3.5MHz	460mV	10MHz	1150mV	21MHz	1840mV	/	/
5.0MHz	690mV	14MHz	1380mV	24MHz	2070mV	/	/

Performance parameter

General parameters

Frequency Range: receive: 0.5MHz~30MHz
 transmitting: 160M~10M (Amateur radio band only)
transmitting mode: A1A(CW), A3E(AM), J3E(USB/LSB), F3E(FM)
Mini step: 10Hz
Antenna impedance: 50Ω
Range of operating temperature: 0°C ~ +50°C
Frequency stability: ±10 ppm for 10 to 60 min after power on @25°C: 1ppm/h
Voltage: 10.5~16.5VDC, Negative ground
Electric current: receive: 500mA@ Max
 transmitting: 8A@ Max
Case size: 120*45*210mm (W*H*L) (Noprotrusions)
Weight: about 1.63kg (only case)

Transmitter parameters
RF output power: 20W (SSB/CW/FM)
 5W (AM Carrier) @13.8VDC
Modulation type: Digital modulation
Stray radiation suppression: ≥50dB
Carrier suppression: ≥40dB
Mic impedance: 200~10k (conventional 600Ω)

Receiver parameters

Circuit type: ZIF
Adjacent channel suppression: ≥60dB
Sideband suppression: ≥60dB

Sensitivity:

	SSB/CW/FM	AM
1.0~1.79999MHz	/	10uV
1.8~27.99999MHz	0.25uV	2uV
28~30MHz	0.25uV	2uV

(PRE=on, ATT=off, NB=off, NR=off, SSB/CW/AM = 10dB S/N, FM = 12dB SINAD)

Image rejection : 70dB

IF suppression : 60dB

Audio output : 0.5W (8Ω, ≤10% THD)

Audio output impedance: 4~16Ω

- ◆ For the above parameters, we may make adjustments without notice.
- ◆ The operating frequency range of the transceiver will vary with the machine version, please consult your dealer.

Packing List

Item name	Quantity
G90	1pcs
Multi-function handle	1pcs
Data cable	1pcs
power cable	1pcs
Operation Manual	1pcs
Warranty Card	1pcs
Certificate	1pcs

*** Optional accessories**

Item name	Description
CE-19	ACC expansion adapter
XPA125B	100W power amplifier (with built-in antenna adjuster)
GSOC*1	G90 dedicated large screen controller

*1 The GSOC controller is expected to be available in 2019.

Connection diagram between G90 and XPA125B

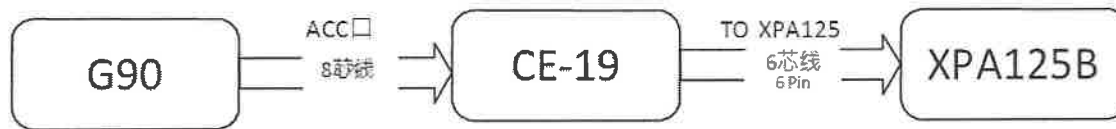

*note: The 8-core ACC control line is delivered in the CE19 kit.

CE-19 expansion adapter interface diagram



- PTT CON PTT signal / BAND signal output port. The PTT signal of this port is completely isolated from the host, providing a "low level" trigger associated with the host.
- TO XPA125B XPA12B dedicated interface.
- AF CON Audio input/output port. The audio output from this port is directly output after demodulation, no filter.
- DATA CON Data output port in NFM mode. The two terminals of this port are in parallel relationship and both output the same signal.

Copyright Notice

All rights reserved 2018

Chongqing Xiegu Technology Co., Ltd. reserves all rights to this manual, and reproduction of any part of this manual is prohibited without permission.

V1.0.01

I010160204-C