

**MIDLAND®**



# 77-250CXL

**OWNER'S MANUAL**

40-channel mobile citizens band transceiver.

# Contents

Midland 77-250CXL features	5-6
Installation instructions	7
Accessories included	7
Location selection	7
Mechanical mounting	8
Power wiring	8
Microphone hanger	9
Optional remote speaker	9
Optional Public Address Speaker	9
Antennas	10
Selection (minimum requirements)	10
Effect of location on performance	10
Installation	10
Tuning	10
Operating instructions	11
Operating controls, connectors	12-13
Functions and uses	12-13
General CB information	14
Channel 9 usage	14
10-Code usage	15
Channel frequency chart	16
Range	16
ESP2™ noise reduction	16
Noise	16
Trouble-shooting aids	17
Noise suppression	17
Common problems and solutions (chart)	18
Technical specifications	18
Written specifications	18
Service and Warranty information	19

# Midland 77-250CXL

40-channel mobile  
CB transceiver.

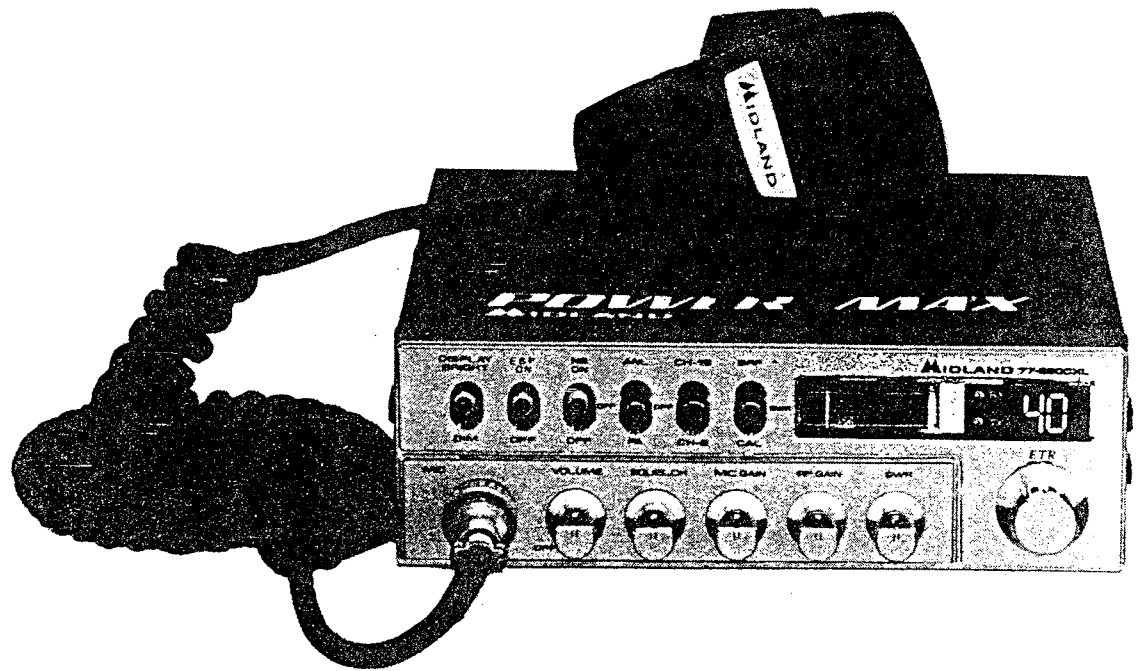

## Features:

State-of-the-art techniques have been used in the electronics of your new Midland CB.

Including Midland Power performance—with a transmitter rated for legal maximum 4-watt output power with high level modulation in accordance with FCC Part 95.

Plus a highly sensitive, selective dual conversion superheterodyne receiver with a tuned RF stage, ceramic filters and built in, automatic noise limiter--certified to FCC Part 15 requirements.

Outside, it's designed to give you the most convenient operation possible.

No other design aspect has been given more attention than the time and motion -saving features built into your new radio, microphone and mounting system.

You'll find and enjoy the benefits of this attention to detail all across the control panel. For example:

- New large-scale, easy-reading LED 40-channel indicator.
- Volume control.
- Full-range, variable squelch control.

- Variable mic gain control.
- True Analog Signal/Power/Modulation/SWR Meter.
- SWR-CAL-S/RF meter switch.
- RF gain control.
- SWR calibrate control.
- Front-mounted, screw on deluxe microphone.
- CB-PA switch permits use as a public address amplifier.
- ANL (Automatic Noise Limiter) "Off" switch. Noise blanker switch and ESP2™ dynamic noise filter switch.
- Brite-Dim switch.
- Jacks for external speaker and PA speaker.
- Precision PLL (Phase Locked Loop) tuner.
- "Omni-Power" operation on 13.8-volt DC, positive or negative ground.
- Fresh, attractive styling with mounting bracket and retention knobs for easy installation and removal for security.
- CH9-OFF-CH19 Instantly selects CH9 or CH19.



# How to install your Midland mobile CB.

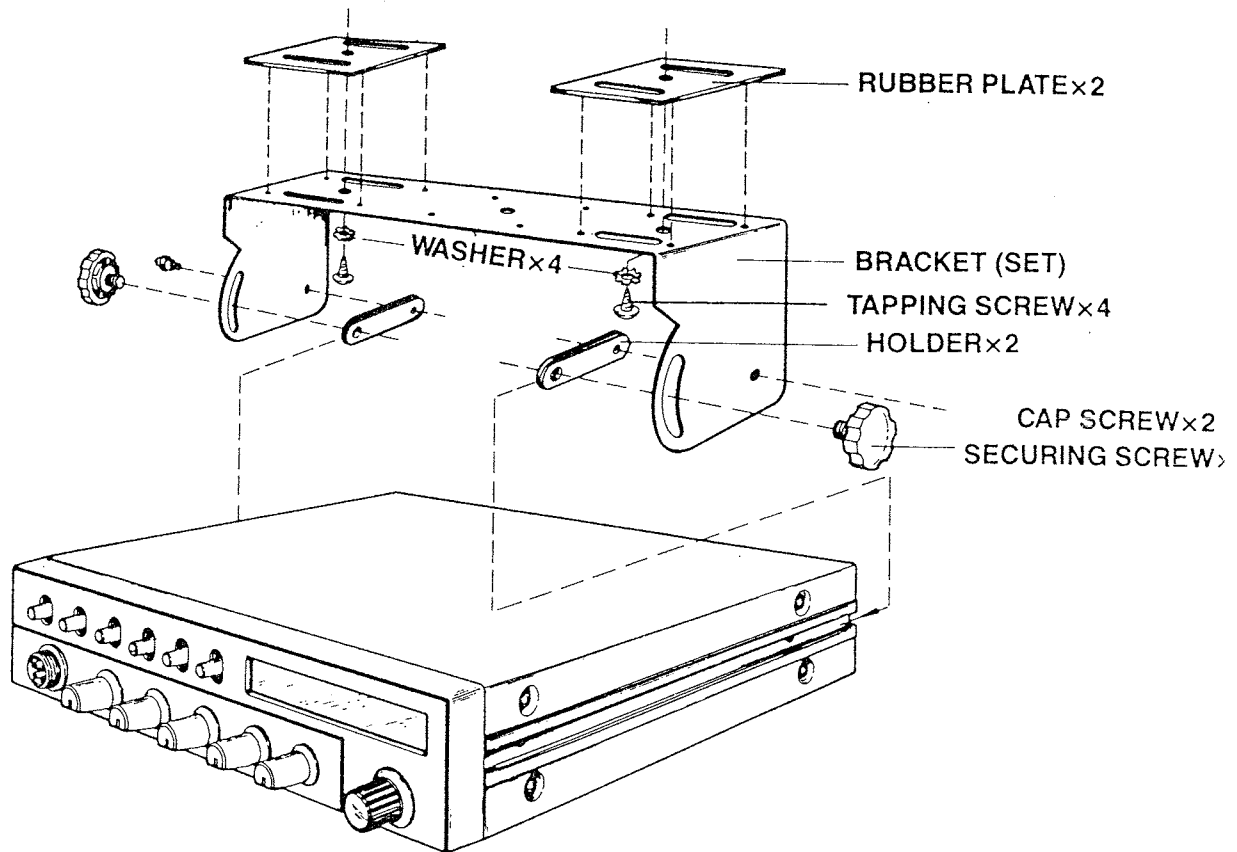

This transceiver may be installed in any **12-volt negative or positive ground-system** car or truck. Most current U.S. and foreign vehicles use a negative system, but some older models and some newer large trucks may have a positive ground.

**Check the requirements for your vehicle before you begin installation.**

Generally, you have a **negative-ground** system if the minus (–) battery terminal is connected to the motor block. Contact your dealer in the event you are unable to determine your vehicle's polarity system.

## Installation and operating accessories furnished with your Midland Mobile CB:

1. Easy-removal mounting bracket system.
2. Microphone bracket system.
3. All main-unit and microphone mounting hardware needed for normal installation.

4. Plug-in microphone with coil cord.
5. Owner's Manual.

## Where to locate your CB transceiver.

Your new Midland CB is designed to be installed under the dash of your vehicle.

Safety and convenience are the primary considerations in deciding exactly where to locate your radio. **Caution:** *Be sure that the unit is located so that it does not interfere with the driver or impair access to any controls. Connecting cables must be routed and secured in such a manner as not to interfere with the operation of the brake, accelerator or other controls. Interference from either the unit or connecting cables may contribute to the loss of control of the vehicle. Also be sure the CB installation does not interfere with airbag operation.*

## Mechanical mounting.

**Step 1:** Heeding the caution, use the mounting bracket as a template for marking the location of screwholes under your dash. Use an awl, nail or other sharp, pointed object to mark the metal.

**Step 2:** Drill a 1/8" hole for each screwhole in the mounting bracket. Attach the bracket to the dash with the 3/8" Phillips machine screws provided. *Extreme care should be exercised when*

*drilling into dash to avoid damage to under-dash electronic ignition, cruise control, instrument airbag, and/or accessory wiring.*

**Step 3:** Locate and secure the radio into the mounting bracket allowing working space for later power connections.

## Power wiring.

**Step 1:** If you have not determined whether your vehicle has a negative or positive ground, do so now. Then disconnect the leads from the battery to prevent short circuits that can occur during wiring.

**Step 2:** With negative ground, connect the red wire — the one with in-line fuse holder — to either the (a) fuse block, (b) cigarette lighter or (c) directly to the positive post on your battery.

(Usually, the fuse block is the most convenient connecting point. It is also possible to connect to the Accessory terminal on the ignition switch, so that your CB automatically goes off when the ignition goes off, preventing accidental

battery drainage.)

Then tightly connect the black wire directly to the vehicle's metal frame.

With a **positive ground**, reverse the wires, connecting the red/fuse-holder wire to the frame, the black wire to your DC power source. A light or meter can be a good aid in locating a suitable power source and ground.

In either case, a good, direct metal-to-metal ground is essential for optimum performance.

**Step 3:** Plug-in the power cord to the receptacle provided on the back of the transceiver.

## CAR'S MOTOR BLOCK OR FIRE WALL GROUND

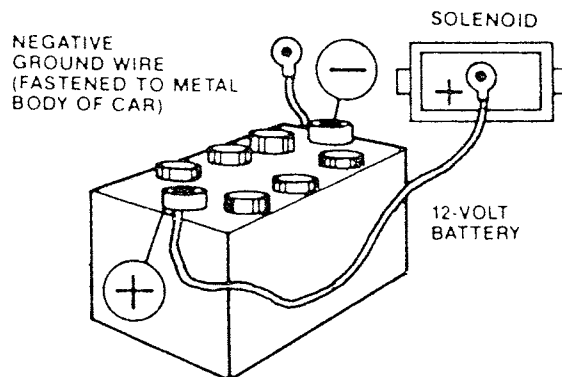

EXAMPLE OF NEG. GROUND 12-V DC CAR BATT CONNECTION ILLUSTRATION MOST CARS & TRUCKS ARE THIS TYPE

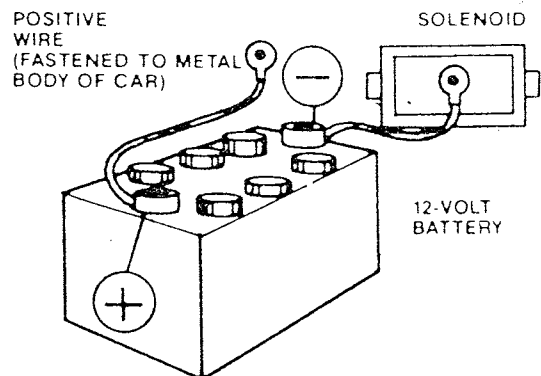

EXAMPLE OF POS. GROUND 12-V DC CAR BATT CONNECTION ILLUSTRATION FEW 18-WHEELERS & OLDER CARS

## Mounting the main unit.

**Step 1:** Position the main unit between the bracket arms in line with the retention knobs. Set the angle for optimum operating comfort and accessibility.

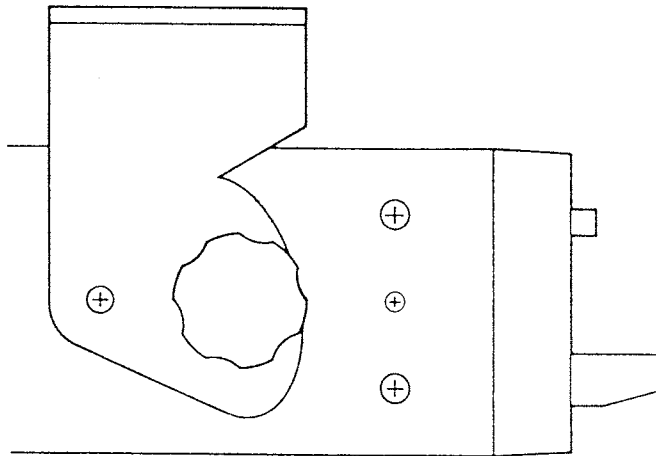

**Step 2:** Tighten the retention knobs

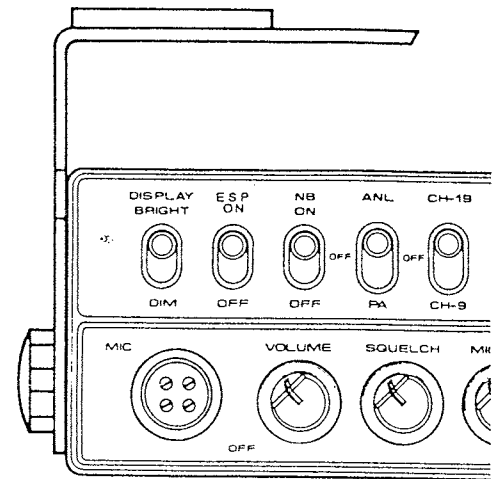

## Installation of microphone hanger.

Mounting holes are provided on the side of the transceiver for the microphone hanger bracket. Alternately, the bracket can be attached to the vehicle dash.

## Connecting optional remote speaker.

Locate the "EXT" jack on the main unit rear panel. Firmly insert and seat the speaker wire plug into the jack.

When connected, the external speaker will override and "blank out" the in-unit speaker standard with your Midland Mobile CB.

## Connecting optional Public Address speaker.

Locate the "PA" jack on the main unit back panel. Firmly insert and seat the speaker wire plug into the jack.

Directions for mounting the optional PA speaker are included along with mounting hardware, with the speaker.

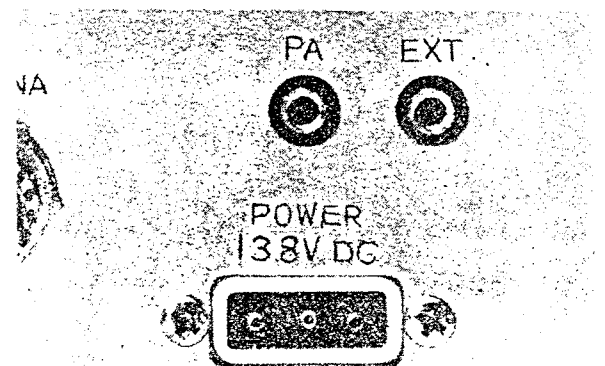
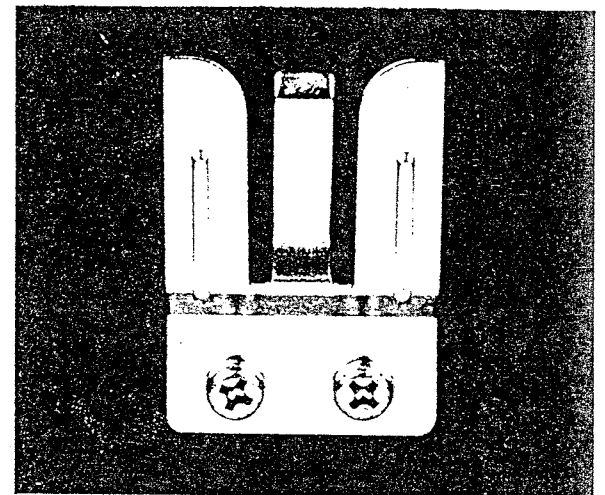

# Antennas: How to select, position, install and tune the right one for you.

Basically, you have two types of mobile CB antennas — full-length whip and loaded whip — and a variety of types of mounts (depending on where you locate your antenna) to choose from.

Midland markets a broad line of high-performance antennas. The dealer who sold you your Midland CB can advise which type is best for you.

## Where you locate your antenna does make a difference.

Some general rules for antenna location that can aid CB performance:

1. Put your mount as high on the vehicle as possible.
2. The higher the proportion of antenna length that is above the roof, the better.
3. If possible, mount the antenna in the center of whatever surface you choose.
4. Keep antenna cables away from noise sources, such as the ignition system, gauges, etc.
5. Make sure you have a solid metal-to-metal ground.
6. Exercise care to prevent cable damage.

Essentially, you have five location choices: the roof, gutter, rear deck, front cowl or rear bumper.

Where you decide to locate your antenna will determine the type of antenna you install. Again, consult your Midland CB Dealer for advice and guidance, and measure your needs against the attributes of the various Midland antenna models he carries.

## Antenna installation.

Follow the manufacturer's installation instructions carefully.

**Warning: Never operate your CB radio without attaching an antenna or with a broken antenna cable. This can result in damage to transmitter circuitry.**

## Tuning your antenna.

Some antennas are factory tuned. However, performance can usually be improved by slightly lengthening or shortening its length, using a Standing Wave Ratio (SWR) meter.

For the exact procedures to be used, refer to the antenna manufacturer's installation manual.

You can buy an SWR meter separately or have your antenna checked by your Midland CB Dealer's service department.

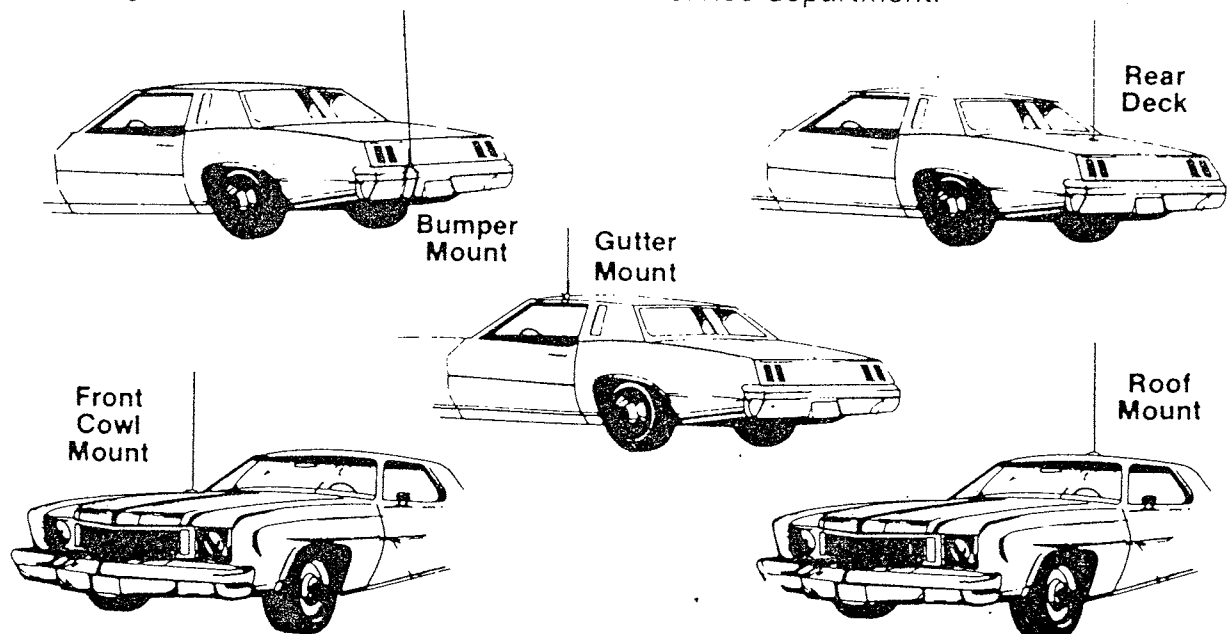



# Midland 77-250CXL Operating Instructions

Having properly installed and wired your CB and antenna, you are now ready for the ten steps designed to get you into effective, satisfactory operation:

**Step 1:** Insert the plug from the microphone into the microphone jack on the face panel and screw on securely.

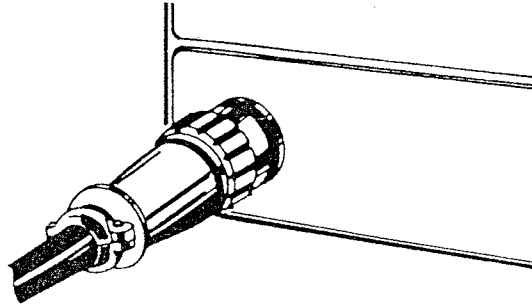

**Step 2:** Make sure your antenna is securely connected to the antenna connector.

**Step 3:** Make sure the Squelch control is in the 9 o'clock position.

SQUELCH

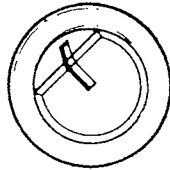

**Step 4:** Make sure the Mic gain control is fully clockwise.

MIC.GAIN

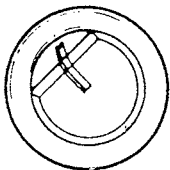

**Step 5:** Turn the power on and adjust the "Volume" control for a satisfactory sound level.

VOLUME

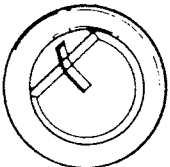

OFF

**Step 6:** Make sure the RF Gain Control is fully clockwise.

RF.GAIN

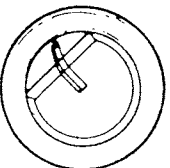

**Step 7:** Make sure the ANL/OFF/PA switch is in the "OFF" or "ANL" position.

ANL

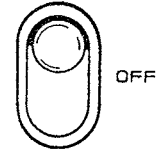

PA

**Step 8:** Put CH19-OFF-CH9 switch in "OFF" position.

CH-19

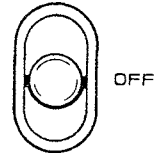

CH-9

**Step 9:** Select your desired channel by turning the Channel Selector dial below the LED digital indicator clockwise (up) or counter-clockwise (down).

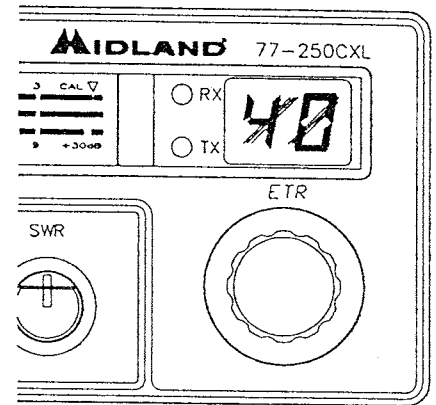

**Step 10:** Place SRF/SWRICAL switch in "S-RF" position.

SRF

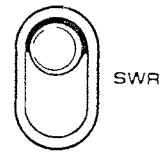

SWR

CAL

**Step 11:** To transmit, press the push-to-talk bar on the microphone. To receive, release the bar.

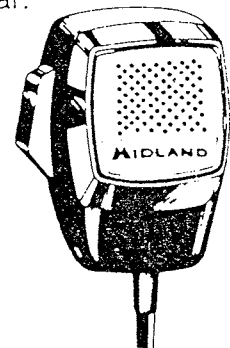

# Operating controls, connectors: Their functions and uses.

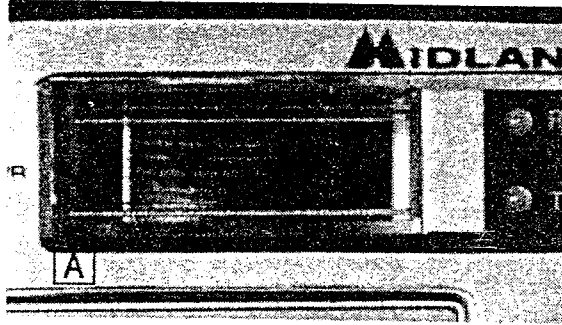

Starting at the upper left (driver's side) of your Midland 77-250CXL and moving counter-clockwise:

**A Electronic S/Rf/SWR/Modulation Meter.** This new high visibility, meter is used four ways: (1) When receiving, it gives the relative strength of incoming signals. (2) When transmitting, it shows RF (Radio Frequency) power output. (3) As an "SWR" meter, it helps match your antenna installation to your transceiver. (4) When transmitting the scale will peak with indicating modulation levels.

**B Microphone Connector.** Securely links your microphone to the main unit during use, yet allows quick disconnection when out of service.

**B Off/Volume Control.** Turns your CB on and adjusts the sound level for comfortable reception.

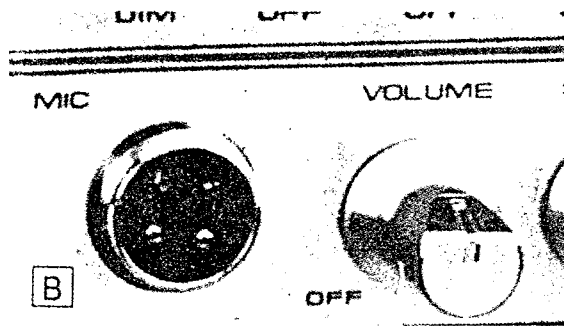

**C Squelch Control.** Turned clockwise, it quiets the receiver when signals are not being received and allows a quiet standby operation.

The Squelch control functions only in the receive mode and does not affect receiver volume when signals are being received.

To adjust, when no signals are present, rotate the Squelch control clockwise until the receiver is quieted.

Incoming signals will automatically release the squelch action.

Careful adjustment is necessary as a setting too far clockwise will not allow weaker signals to release the squelch action.

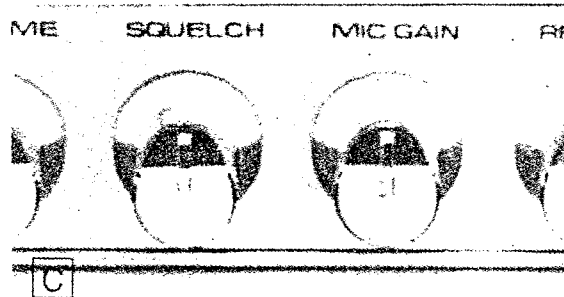

**C Mic (Microphone) Gain Control.** Adjusts the sensitivity of the microphone amplifier circuit to suit individual voice characteristics and ambient noise conditions to provide maximum intelligibility.

Rotating the control counter-clockwise reduces the sensitivity and requires "close talking" into the microphone.

When operating from a noisy vehicle, reducing the Mic Gain setting will usually improve your transmitted voice clarity. Check with other operators to determine the exact setting best for your voice and car.

**D RF Gain Control.** Controls the

reception sensitivity (range) of your CB. To decrease RF Gain—to reduce interference, for example, in congested urban areas—rotate counter clockwise. For full sensitivity position. The RF Gain switch affects reception only. It will not affect transmitter output power.

**D To Measure SWR.**

1. Set the slide switch to SWR-CAL (forward) position.
2. Activate the transmitter (by pressing the microphone push-to-talk bar) and rotate the calibrate control to set the meter to the right side "SET" position.
3. Set the slide switch to SWR position and read the SWR. For example, a reading of 1.5 actually means an SWR of 1.5:1. SWR of 3.0:1 or higher indicates severe antenna mismatch.

**E Lighted LED Digital Channel Indicator.** Clearly displays the channel selected by use of the selector dial just below.

Turn the dial to the right to select a higher-numbered channel spectrum, left to select channels below the number indicated.

**F Brite-Dim Switch.** Dims or brightens lighted controls for more comfortable day or night visibility

**F ESP-OFF.** ESP2™ noise filter adds heavy duty filtering to reduce on air and SKIP noise. see how ESP2™ works on page 16.

**F NB ON-OFF.** Noise blanker switch screens out atmospheric noise.

**G ANL/OFF/PA Switch.** Switches your CB speaker system from a CB function, using the internal, main-unit speaker, to a Public Address function, using an external PA speaker, and back again. When turned on, it operates in the receiver to reduce atmospheric and ignition noise.

**G CH9-OFF-CH19 Memory.** Switch instantly selects channel 9 (highway emergency channel) or channel 19 (highway talk channel). Note: Keep in off position for normal 40 channel operation.

**G S/RF-SWR-CAL Meter Switch.** Selects the mode of the SWR/CAL-S/RF Meter. Rotate to right.

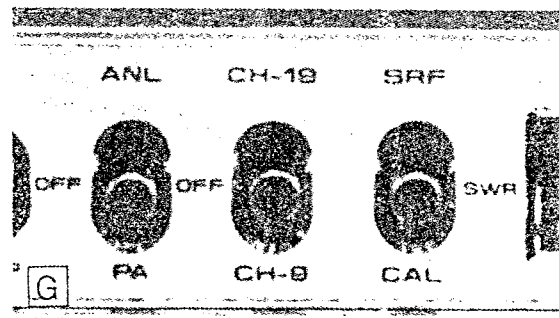
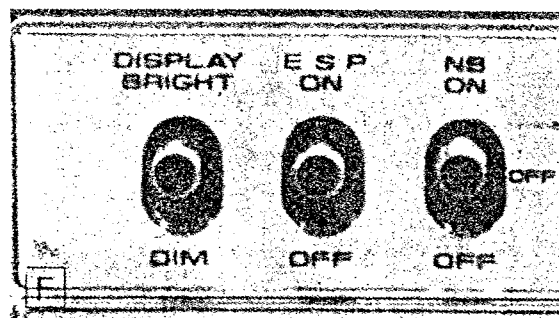
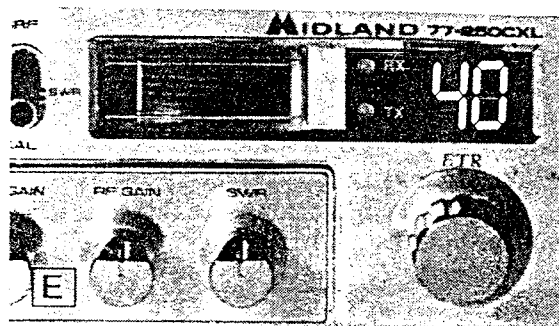
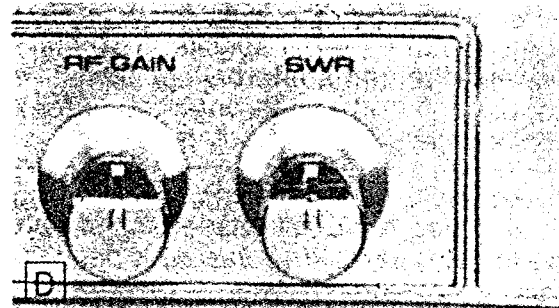

**H External Speaker Jack.** Allows you to attach an external speaker that will override the unit's internal speaker. Connection is made through the External Speaker Jack on the back panel.

**H PA Jack.** An optional PA speaker may be attached to your transceiver through the PA output jack on the back panel. This allows you to communicate with pedestrians or other vehicles through your CB microphone.

**I Microphone Push-To-Talk Bar.** Simply push this bar in to transmit; release when receiving.

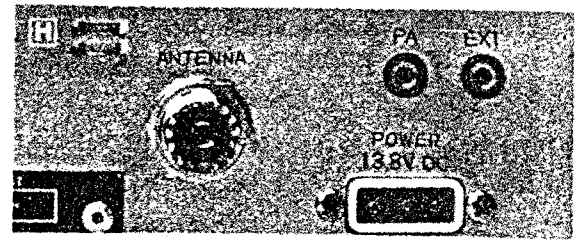

Midland consumer Radio hereby certifies that this unit has been designed, manufactured, FCC type accepted and certified in accordance with Part 95 and Part 15, Subpart C, of the current FCC rules and regulations as of the date of manufacture.

## NOTICE!

EFFECTIVE IMMEDIATELY YOU ARE NO LONGER REQUIRED TO OBTAIN A F.C.C. LICENSE FOR OPERATION OF YOUR CITIZENSBAND TRANSCEIVER.

YOU MAY NOW USE YOUR CITIZENSBAND EQUIPMENT RIGHT AWAY WITHOUT FILLING OUT A FORM OR CONTACTING THE FCC.

## General CB information.

In 1958, The Federal Communications Commission approved the use of 23 channels by duly licensed Citizens Band radio operators. The authorization was expanded to 40 channels in 1977.

A simple, basic means of communication, CB requires no more skill or knowledge than the operation of a standard AM or FM receiver.

Still, there are certain facts, procedures and "rules of the road" you'll need to know in order to make the most of your CB experience.

**Make it "short and sweet."** When using your CB, get on and off the air as quickly as possible. Never use profanity — which is against the law and subject to heavy penalties. Follow the FCC rules outlined in Part 95.

**Use Channel 9 in emergencies only.** Emergency channel 9 is designated for this purpose and this purpose alone.

The FCC has given public safety agencies various "call signs" including "0911" numbers, coinciding with the "911" phone numbers these agencies use in telephone communications.

The call signs for state-level agencies use 3 letters and 4 numbers, with the second and third letters being the official Post Office state abbreviation, e.g., "KS" for "Kansas."

**Why and how to use the "10 Code."** Developed over the years by official agencies in order to save time and provide precise, clear messages, the "10-Code" has become a popular tool for CBers.

The table below lists some of the more common codes and their meanings.

<b>Code</b>	<b>Meaning</b>		
10-1	Receiving poorly.	10-35	Confidential information.
10-2	Receiving well.	10-36	Correct time is.
10-3	Stop transmitting.	10-37	Wrecker needed at.
10-4	OK, message received.	10-38	Ambulance needed at.
10-5	Relay message.	10-39	Your message delivered.
10-6	Busy, stand by.	10-41	Please turn to Channel.
10-7	Out of service; leaving the air.	10-42	Traffic accident at.
10-8	In service, subject to call.	10-43	Traffic tie-up at.
10-9	Repeat message.	10-44	I have a message for you.
10-10	Transmission completed, standing by.	10-45	All units within range report.
10-11	Talking too fast.	10-50	Break channel.
10-12	Visitors present.	10-60	What is next message number
10-13	Advise weather/road conditions.	10-62	Unable to copy; use phone.
10-16	Make pickup at.	10-63	Network directed to.
10-17	Urgent business.	10-64	Network clear.
10-18	Anything for us?	10-65	Awaiting your next message/assignment.
10-19	Nothing for you; return to base.	10-67	All units comply.
10-20	My location is.	10-70	Fire at.
10-21	Call by telephone.	10-71	Proceed with transmission in sequence.
10-22	Report in person to.	10-77	Negative contact.
10-23	Stand by.	10-81	Reserve hotel room at.
10-24	Completed last assignment.	10-82	Reserve room for.
10-25	Can you contact?	10-84	My telephone number is.
10-26	Disregard last information.	10-85	My address is.
10-27	I am moving to Channel.	10-91	Talk closer to mike.
10-28	Identify your station.	10-93	Check my frequency on this channel.
10-29	Time is up for contact.		
10-30	Does not conform to FCC rules.	10-94	Please give me a long count.
10-32	I will give you a radio check.	10-99	Mission completed; all units secure.
10-33	Emergency traffic.		
10-34	Trouble at this station.	10-200	Police needed at.

## Frequency-channel number chart.

Frequency	Channel
26.965 MHz _____	1
26.975 MHz _____	2
26.985 MHz _____	3
27.005 MHz _____	4
27.015 MHz _____	5
27.025 MHz _____	6
27.035 MHz _____	7
27.055 MHz _____	8
27.065 MHz _____	9
27.075 MHz _____	10
27.085 MHz _____	11
27.105 MHz _____	12
27.115 MHz _____	13
27.125 MHz _____	14
27.135 MHz _____	15
27.155 MHz _____	16
27.165 MHz _____	17
27.175 MHz _____	18
27.185 MHz _____	19
27.205 MHz _____	20
27.215 MHz _____	21
27.225 MHz _____	22
27.255 MHz _____	23
27.235 MHz _____	24
27.245 MHz _____	25
27.265 MHz _____	26
27.275 MHz _____	27
27.285 MHz _____	28
27.295 MHz _____	29
27.305 MHz _____	30
27.315 MHz _____	31
27.325 MHz _____	32
27.335 MHz _____	33
27.345 MHz _____	34
27.355 MHz _____	35
27.365 MHz _____	36
27.375 MHz _____	37
27.385 MHz _____	38
27.395 MHz _____	39
27.405 MHz _____	40

## Factors affecting effective CB range.

Essentially, they're the same influences that optimize or limit AM, FM and other kinds of performance in moving vehicles:

**Terrain:** Hills and valleys naturally interrupt and shorten CB signals.

**Weather.** You can expect that CB range will be reduced—perhaps drastically—in times of atmospheric disturbance, such as in a thunderstorm or heavy snow. Sunspots, too, are known to adversely affect CB performance.

**Obstructions.** Inside a tunnel, covered parking garage or viaduct, CB sending/receiving capability may be cut off altogether.

In short, you can expect to maintain maximum transmitting/receiving performance in flat, open country in stable (not necessarily clear) weather conditions.

Should effective range be limited in these conditions, check to see that your CB is connected properly and your antenna adjusted correctly. It may be necessary to consult your Midland CB Dealer's service department.

## How ESP2™ works to make your CB sound better.

The ESP2™ noise reduction system constantly monitors the signal strength and the type of noise present. When the signal strength is too low for good reception, the receiver sound is automatically adjusted to dramatically reduce the noise that comes through the speaker. While the noise is decreased the actual sounds you need to hear are increased.

Skip interference can cause whistles and howling sounds. Electrical interference from power lines, ignition systems or other sources can produce low humming and buzzing noise. These high and low sounds are not needed communications. ESP2™ can determine the difference between undesired noises and

sounds you want to hear and filter the noises out.

ESP2™ can accomplish this without decreasing receiver range (it usually increases range). Most importantly, ESP2™ works by itself and does not need to be listening to other ESP2™ equipped CB's to be 100% effective.

The end result of ESP2™ is that you can lower or completely stop using your squelch control. You will hear weak signals that cause other CB's to hear only noise. With this new patented sound control system you will find yourself using your CB more thereby increasing your safety and enjoyment.

#### **What causes noise?**

If you have an abnormal noise problem, the chances are your vehicle itself is the cause.

A CB receiver is a very sensitive instrument, able to pick up small noise signals and amplify them—particularly if the source of these signals is within a few feet of your CB.

Any noise that comes from your CB almost certainly comes from outside the unit itself. Devices have been designed into your Midland CB (a noise blanker or an automatic noise limiter, for example) to minimize this kind of distraction.

#### **Trouble-shooting aids.**

Frequently, there are simple, quick actions you can take to eliminate or minimize such problems as interference and noise.

#### **Noise suppression.**

A very common source of excessive noise is the ignition system of a CB owner's vehicle. If you suspect this is true, simply turn off the ignition and set the key in the accessories (ACC) position.

This way you'll provide power to the transceiver, minus any ignition interference that might exist. If the noise goes away, you know instantly that the ignition system is the culprit.

Still, there are a number of places in the ignition system where noise can originate.

Sparkplugs and sparkplug wires are probably the worst noise producers. To eliminate this kind of noise, you can take any of four simple measures: (1) Install resistive sparkplug suppressors, (2) resistor sparkplugs or (3) resistance-wire cabling, between plugs and the distributor and also between the distributor and ignition coil. (4) Replace old plugs and sparkplug wiring and properly tune the engine. This generally cures most noise.

Many cars come suppressor-cable equipped. If yours didn't (consult your vehicle owners manual or dealer service department to be sure), you can get it at any auto supply store and, given a moderate amount of mechanical skill. Install it yourself.

**Caution: Do not undertake any ignition-system repairs or modifications without either professional help or some automotive service experience.**

Generator-brush sparking can create an annoying "whine." It's caused by a dirty commutator and is eliminated by polishing its surface with fine-grade emery cloth, and cleaning grooves with a small, sharp tool.

Voltage regulators can cause a "hashy" sound in your CB when relay contacts jitter open and closed when the battery is fully charged. To eliminate this noise, mount coaxial feedthrough capacitors at the battery and armature terminals of the regulator box.

Alternator slip rings should also be kept clean and good brush contact maintained to minimize CB noise.

In addition, single-contact alternator regulator boxes need a coaxial capacitor at the ignition terminal. Double-contact units should have a second capacitor at the battery terminal. Shielding between the regulator and alternator may be needed as well. Be sure to ground the shield at both ends.

Infrequent, though real, noise generators like your car's heat fan, turn signals, electric windows and windshield-wiper motors can also be silenced with a coaxial capacitor (consult your serviceman).

**Wheels and tires** can also cause CB noise also. Wheel noise is eliminated by putting static-collector springs between the wheel spindle bolt and grease retainer cup. Tire static can be quieted with antistatic powder applied inside each wheel.

**Antenna corona-discharge noise** — most frequently occurring with sharp-pointed "whip" models — can happen just before or during electrical storms. The only cure is for the storm to blow over or pass.

**SOLUTIONS:**

**COMMON CB PROBLEMS:**

	Check CB-PA switch.	Check power cable connection.	Check 2-amp fuse.	Check Squelch adjustment.	Check on/off switch.	Change to active channel.	Check antenna connection.	Fully depress push-to-talk bar.	Check microphone connection.	Check metal-to-metal ground connection.	Check antenna cable and SWR adjustment.
No sound or channel light.	•	•		•				•			
Channel light but no sound.	•		•		•		•	•			•
No voice reception.			•		•						•
Poor reception.					•		•	•	•		
Transmission problems.					•	•	•	•	•		
Unclear reception.					•			•	•	•	
Poor PA Audio Frequency.	•										
Inoperative channel selector.	•										

*Caution: The 2-amp fuse included with this unit is an important safety feature which must not be circumvented. Removal of this fuse or the use of a fuse greater than 2 amps may result in overheating and/or fire and consequential damage to the unit or vehicle. If a replacement 2-amp fuse burns out, have the unit inspected and repaired by a qualified service technician.*

# Midland 77-250CXL mobile CB Transceiver: Technical Specifications.

**General Construction.**

1. Unit size; 2 x 5/16" H x 7 9/32" W x 7 5/16" D
2. Unit weight: 4.52 lbs. (approximate)
3. Shipping weight: 5.6 lbs. (approximate)
4. 4 PIN Screw on microphone connector.
5. No mechanical relays. All switching is solid state using diodes and transistors for high reliability.
6. Transmitter output stage is protected from mismatch, no-load or short-circuit conditions.
7. Input power is suitably filtered and bypassed to prevent alternator "whine" on transmit or receive.

**Electrical Specifications.**

All test conditions and methods are in

accordance with EIA standards RS-382 and RS-424 or applicable government regulations.

**Frequency Control:** PLL

**Receiver Sensitivity:** 0.3µV for 10 dB (S+N)/N.

**Receiver Selectivity:** More than 50 dB ± 10 KHz

**Controls:** On/off/volume. Variable squelch. S/RF/SWR meter. SWR-CAL-S/RF meter switch. CB/PA. RF Gain. DNF, NB, CH9/CH19 switches. ANL Brite-Dim switch. Mic Gain. Channel selector. LED digital readout channel indicator. Push-to-talk (on microphone).

**Jacks and Connections:** Microphone. 50-ohm antenna. 8-ohm external speaker. PA speaker.

**Accessories Included:** 500-ohm push-to-talk microphone with coil cord and plug-in connector. Microphone clip. Slotted mounting bracket and hardware. Owner's manual. FCC forms 505, 555-B, Part 95 Subpart D, DC power cord with 3-pin connector.



## Limited Warranty.

Midland Consumer Radio will repair or replace, at its option, without charge, any midland mobile CB, which fails due to a defect in material or workmanship within one year following the initial consumer purchase.

This warranty does not include any carrying cases, earphones, or telescoping antennas which may be a part of or included with the warranted product, or the cost of labor for removal or reinstallation of the product in a vehicle or other mounting.

Performance of any obligation under this warranty may be obtained by returning the warranted product, freight prepaid, along with proof of purchase, to Midland Consumer Radio, Warranty Service Department, 1670 North Topping, Kansas City, Missouri 64120 or to any "Midland Authorized CB Warranty Service Station," or to the place of purchase (if a participating dealer).

Warranty information and the location of the nearest "Midland Authorized CB Warranty Service Station" may be obtained by writing Midland Consumer Radio Warranty Service Department.

This warranty gives you specific legal rights, and you may also have other rights which vary from state to state.

Note: The above warranty applies only to merchandise purchased in the United States of America or any of its territories or possessions or from a US military exchange. For warranty coverage on merchandise purchased elsewhere, consult the supplemental warranty information included with this product or ask your dealer.