

Blue  *Star*

By **MIDLAND**[®]

BR777

TWO-WAY RADIO

OWNER'S MANUAL



TABLE OF CONTENTS

TABLE OF CONTENTS	1
Introduction	2
Important Notice, FCC Licensing	3
LCD Display	4
Controls	5
Battery Installation	6
Installing the Belt Clip	7
Installing the Swivel Holster	7
Charging the Battery Pack	8
Charging thru the Multi-Unit Charger	9
Battery Level Indicator	9
Operating Your Radio	10 - 11
Factory Default Setting	12
Programming your Radio Settings	13 - 16
Keypad Lock	17
External Speaker/Microphone Jack	17
Troubleshooting Guide	18
Use and Care	18
Specifications and Frequency Charts	19 - 21
Warranty Information	22
Accessories	23 - 24

Welcome to the world of Midland electronics

Congratulations on your purchase of a high quality MIDLAND product. Your 2-way radio represents the state-of-the-art in high-tech engineering. Designed for Business Radio operation, this compact package is big in performance. It is a quality piece of electronic equipment, skillfully constructed with the finest components. The circuitry is all solid-state and mounted on a rugged printed circuit board. Your two-way radio is designed for reliable and trouble-free performance for years to come.

Features

- 4 Selectable Channels
- 56 Programmable Frequencies
- 121 Privacy Codes
- VOX
- CALL Alert Function
- VIBRATE Alert Function
- SCAN Function
- Cloning Capability
- Auto-Squelch Function
- Key Pad Lock
- Speaker / Microphone Jack
- Battery Meter / Battery Low Indicator

This device complies with Part 15 of the FCC Rules. Operation is subject to the following two conditions : (1) this device does not cause harmful interference, and (2) this radio must accept any interference that may cause undesired operation.

To maintain compliance with FCC's RF exposure guidelines, for body-worn operation, this radio has been tested and meets the FCC RF exposure guidelines when used with Midland Radio Corp. accessories supplied or designated for this product. Use of other accessories may not ensure compliance with FCC RF exposure guidelines. (Tested with Headset Model: AVP-1)

IMPORTANT NOTICE FCC LICENSE REQUIRED FOR BUSINESS RADIO OPERATION

The BR777 operates on UHF frequencies which require an FCC (Federal Communications Commission) license. You must be licensed prior to operating on these frequencies. Serious penalties could result for unlicensed use of these frequencies, in violation of FCC rules, as stipulated in the Communications Act's Sections 501 and 502 (amended).

You will be issued a call sign by the FCC which should be used for station identification when operating the radio on these channels. You should also cooperate by engaging in permissible transmissions only, avoiding channel interference with other users, and being prudent with the length of their transmission time.

To obtain a license or ask questions about the license application, contact the FCC at 1-888-CALL FCC or go to the FCC's website: <http://www.fcc.gov> and request form **601**.

Exposure To Radio Frequency Energy

Your Midland radio is designed to comply with the following national and international standards and guidelines regarding exposure of human being to radio frequency electromagnetic energy:

- United States Federal Communications Commission, Code of Federal Regulations: 47 CFR part 2 sub-part J
- American National Standards Institute (ANSI)/Institute of Electrical & Electronic Engineers (IEEE) C95. 1-1992
- Institute of Electrical and Electronic Engineer (IEEE) C95. 1-1999 Edition
- National Council on Radiation Protection and Measurements (NCRP) of the United States, Report 86, 1986
- International Commission on Non-Ionizing Radiation Protection (ICNIRP) 1998

To control your exposure and ensure compliance with the general population or uncontrolled environment exposure limits, transmit no more than 50% of the time. The radio generates measurable RF energy exposure only when transmitting.

IMPORTANT: Changes or modifications to this unit not expressly approved by **MIDLAND RADIO CORP.** and **BLUE STAR** could void your right to operate this unit. Your radio is set up to transmit a regulated signal on an assigned frequency. It is against the law to alter or adjust the settings inside the **COMMUNICATOR** to exceed those limitations. Any adjustment to your radio must be made by qualified technicians.

LCD DISPLAY



1. **BATTERY METER** – Indicates the battery level.
2. **KEY LOCK ICON** – Indicates KEY LOCK mode is on.
3. **RECEIVE (RX)/TRANSMIT (TX) ICON** – Indicates radio is transmitting a signal or receiving a transmission.
4. **VOX ICON** – Indicates when VOX mode is active.
5. **CHANNEL NUMBER** – Indicates the Channel (1~4) setting.
6. **PRIVACY CODE** – Indicates Privacy Code selected by user (oF~121).
7. **VIBRATE-ALERT ICON** – Indicates when the Vibrate-Alert feature is on.
8. **TRANSMIT POWER LEVEL ICON** – Indicates TX Power setting(Blank/Lo).
9. **PROGRAM ICON** – Indicates radio is in Programming mode.
10. **CLONE ICON** – Indicates radio is in Cloning mode.
11. **PRIVACY CODE ICON** – Indicates radio is in Privacy Code programming mode.
12. **FREQ CODE ICON** – Indicates radio is in Frequency programming mode.

CONTROLS

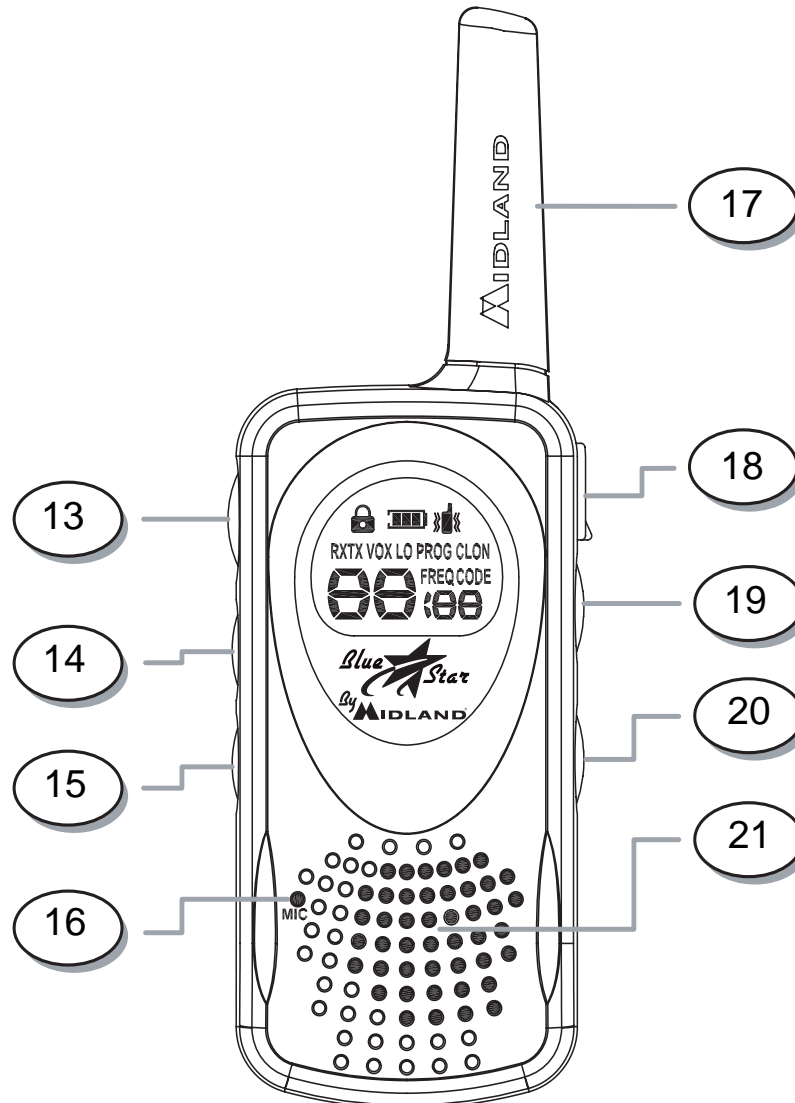

- 13. PTT Button** – Press and hold to transmit voice communication.
- 14. UP Button** – Increase the volume level or make adjustments in Program mode.
- 15. DOWN Button** – Decrease the volume level or make adjustments in Program mode.
- 16. MIC** – Built-in microphone.
- 17. ANTENNA.**
- 18. EXTERNAL SPEAKER/MIC JACK.**
- 19. SCAN/CALL/KEYLOCK Button** – Press and hold within 2 seconds then release to enter SCAN mode. Press twice quickly to send CALL Alert tone. Press and hold to turn on/off the Keylock function.
- 20. MODE/POWER ON/OFF Button** – Press and hold to turn the radio on/off. Press to activate the MENU mode.
- 21. SPEAKER** – Built-in speaker.

BATTERY INSTALLATION

Your BR777 radio operates with 3.7Vdc 650mAh Li-ion Battery Pack (BATT7L). The belt clip should be removed (see INSTALLING THE BELT CLIP) to ease installation or removal of the batteries.

To install the batteries:

1. With the back of the radio facing you, remove the belt clip (see INSTALLING THE BELT CLIP) for easy access, then remove the Battery Cover by pressing down on the top center and sliding it down from the radio.
2. Insert the Li-ion Battery Pack, observing the polarity as shown. Installing the batteries incorrectly will prevent the unit from operating or may damage the unit.
3. Return the Battery Cover by sliding it up on the radio. Replace the belt clip.

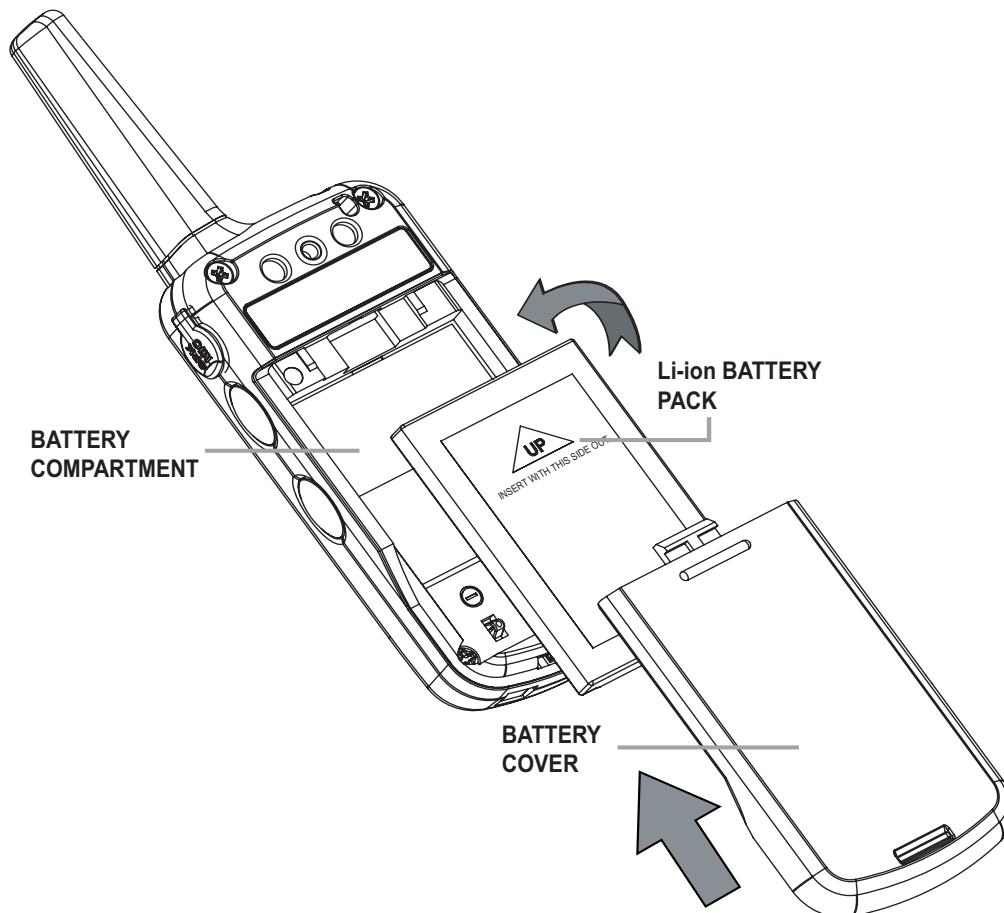

INSTALLING THE BELT CLIP

To install the **BELT CLIP**, use a screwdriver to attach the belt clip to the radio. Turn the screwdriver clockwise to tighten the belt clip screw. Turn the screwdriver counter-clockwise to loosen/remove the belt clip screw.

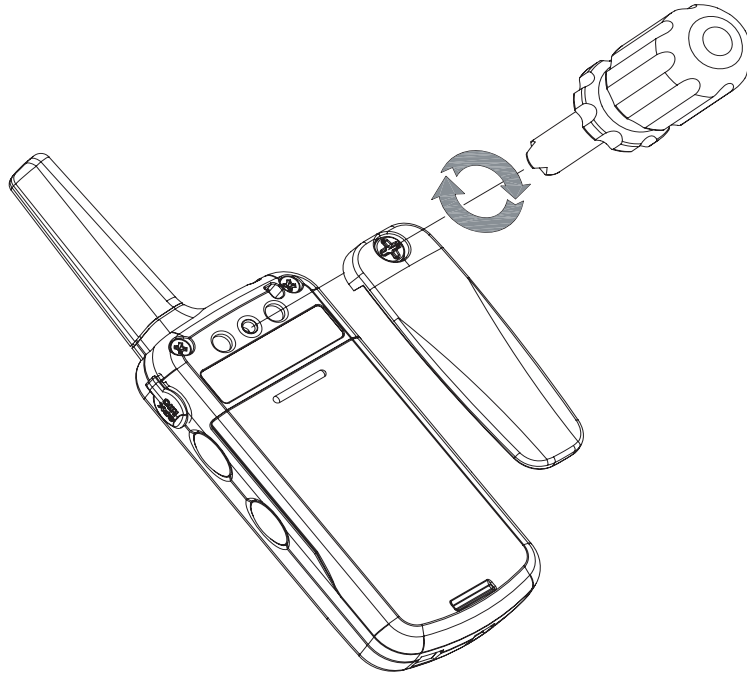

INSTALLING THE SWIVEL HOLSTER

To install the **SWIVEL HOLSTER** (optional), slide the radio (with the Belt Clip attached) down into the slot on the Swivel Holster until the **HOLSTER LOCK TAB** clicks. To remove the **SWIVEL HOLSTER**, press the **HOLSTER LOCK TAB** up, then gently pull the radio up from the **SWIVEL HOLSTER**.

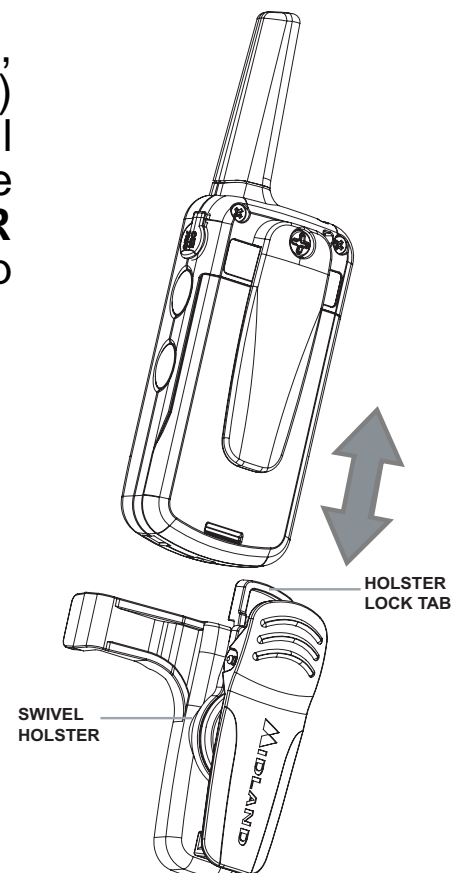

CHARGING THE BATTERY PACK

Your BR777 is equipped for using a rechargeable Li-ion Battery Pack which can be recharged using a desktop charger (BRC501). Initial charge time is 2 hours with a charge time of 2 hours thereafter. For maximum battery life, we recommend charging the battery pack when the low battery icon comes on.

To charge using a Desktop Charger (BRC501):

1. Turn off the unit.
2. Place the rechargeable battery packs in the radios.
3. Connect the AC adapter (18AD2) into an AC wall outlet.
4. Insert the AC adapter plug into the desktop charger jack.
5. Place the units into the desktop charger slot and note that the LED indicator with **RED** color will light up, indicating charging function. Once the battery packs are fully charged, the LED indicator will change to **GREEN** color.

In order to ensure that the battery pack is fully charged, it is recommended that the battery pack be charged with the radio turned OFF.

- 
1. Only use our Li-ion battery pack.
 2. Do not attempt to charge any battery packs other than the one indicated in the manual. This may cause leakage and damage to the radio.
 3. For long term storage of the radio, turn the radio OFF and remove the batteries from the radio.

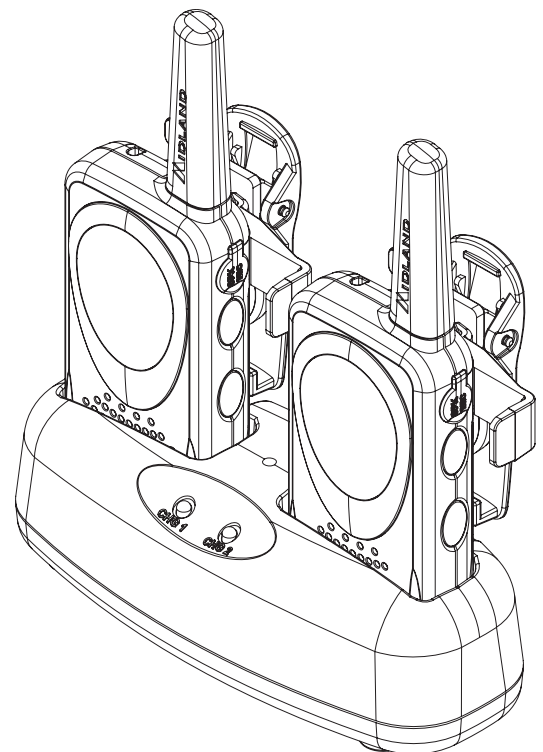

CHARGING THRU THE MULTI-UNIT CHARGER



The BRC601 Multi-unit charger (not included) allows charging of up to 6 radios at the same time.

To charge using the Multi-unit Charger (BRC601):

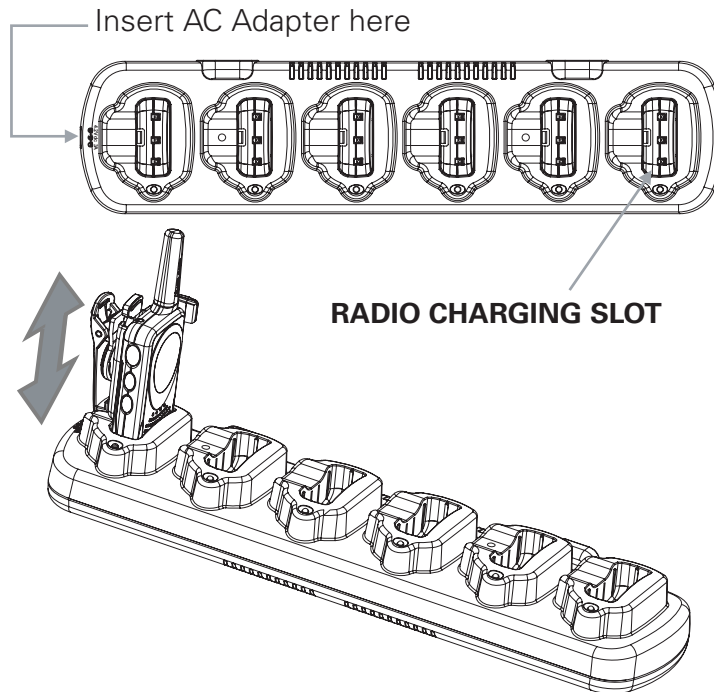
1. Turn off the units.
2. Place the rechargeable battery packs in the radios.
3. Connect the AC adapter (18AD6) into an AC wall outlet.
4. Insert the AC adapter plug into the Multi-unit charger jack.
5. Place the units into the desktop charger slot and note that the LED indicator with **RED** color will light up, indicating charging function. Once the battery packs are fully charged, the LED indicator will change to **GREEN** color.



BATTERY LEVEL INDICATOR

Your BR777 has a **BATTERY LEVEL METER**  that shows the battery power level. The greater the number of bars visible, the stronger the battery level. When the battery level is low, the **Battery Meter** icon will display the **Battery Shell**  only; indicating your Li-ion Battery Pack should be replaced or recharged. If the Li-ion Battery Pack is not charged at this time, the radio will automatically turn off after a few minutes to save the remaining battery energy.

OPERATING YOUR RADIO

POWER ON/OFF

Press the **MODE** button for 3 seconds to turn the radio on. During Power On, the radio will beep 2 times with different tones, the LCD will display all icons for 1 second and the LCD display will indicate the last channel selected.

To turn the radio off press the **MODE** button for 3 seconds.

TRANSMITTING AND RECEIVING A CALL

To communicate, all radios in your group must be set to the same channel, frequency and Privacy Code.

1. For maximum clarity, hold the radio 2 to 3 inches from your mouth.
2. Press and hold the **PTT** button and speak in a normal voice into the **microphone**. The **TX** icon will appear continuously on the LCD Display while transmitting.

To transmit a **CALL Alert Tone/Vibrate Alert**, press the **SCAN** button twice rapidly.

3. To receive a call, release the **PTT** button. The **RX** icon will appear on the display when your radio is receiving a transmission.

RECEIVE SIGNAL STRENGTH INDICATOR

During receiving a transmission, the **Signal Strength Indicator** number will appear on the right side of the LCD display. This meter is on a scale of 1 to 4, with a "4" indicating a strong signal and a "1" indicating a weak signal.

SETTING THE VOLUME LEVEL

To increase/decrease the Volume Level, press the ▲\▼ button during standby or receiving mode. The LCD will display the current volume setting.

CHANNEL SELECTION

Press the **MODE** button once, and then the ▲\▼ buttons to select one of the 4 channels.

To confirm the selection, just wait for around 1 second until the **FREQ** icon disappears and the **CODE** icon appears.

TRANSMIT (TX) POWER LEVEL SELECTION

Your BR777 radio has 2 power level settings. To select the power level on any channel, press and hold the **PTT** button, then press the ▲ button to select Hi Tx Power Level setting, or press the ▼ button to select Lo TX Power Level setting.

If you select **blank** on the TX Power setting icon, then the TX Power will be set to Hi Power.

If you select “**Lo**” on the TX power setting icon, the TX Power will be set to Lo Power.

Note : When you press the PTT button while the Battery level is low (shown by ) , the TX Power setting will change automatically from Hi to Lo (if original setting is Hi)

● **You cannot change the TX Power setting when the radio is in VOX mode.**

SCAN

Your BR777 radio can scan all 4 channels for activity.

To enter the SCAN mode, press and hold the **SCAN** button for 2 seconds and release.

Your radio will rapidly scan each of the 4 channels and stop on any active channel. Your radio will resume scanning after 4 seconds.

When you press the **PTT** button to transmit on an active channel, the scanning function will stop and remain on the active channel for 5 seconds before resuming scan when the **PTT** button is no longer pressed.

To exit the SCAN mode, quickly press the **SCAN** button while the radio is scanning.

FACTORY DEFAULT SETTING

Your BR777 radio is programmed at the factory to the following settings:

Channel	Frequency
1	2
2	8
3	5
4	6
Privacy Code	1
Scan List	y
Call Tone/ Vibrate Alert	0
VOX setting	0

To restore the factory settings:

Start with the radio powered off and press and hold the **PTT** button, ▲ and ▼ button simultaneously while you power the radio on; done by pressing the **MODE** button for 3 seconds or until an “**EP**” will be displayed on the LCD.

Release the buttons.

Press the ▲ button and a “**CL**” will appear next to the “**EP**”.

Press the **MODE** button again for around 3 seconds to turn the radio off.

During this time, the radio will be set to the original factory setting.

BR777 PROGRAMMING QUICK REFERENCE CHART

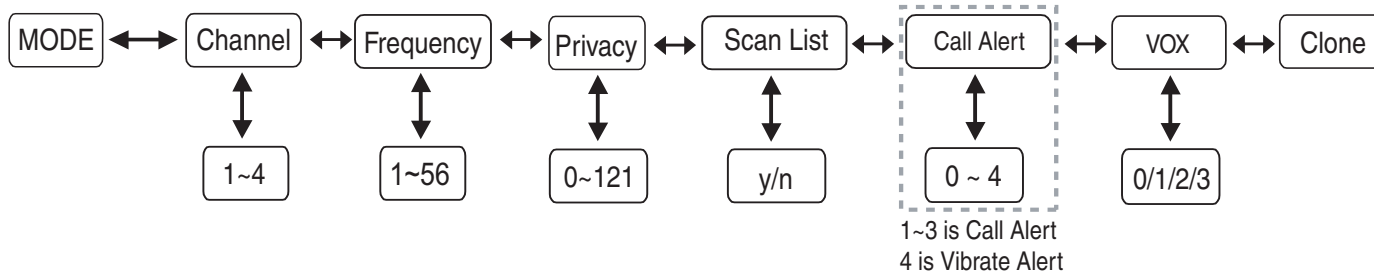

PROGRAMMING YOUR RADIO SETTINGS

Programming mode allows you to change the following settings on your radio:

- Channel (1~4)
- Frequency (1~56)
- Privacy Code (0~121)
- Scan List (y/n)
- Call Alert/Vibrate Alert (0~4; 4 is for Vibrate Alert)
- VOX (0/1/2/3 ; 0 is off)
- Cloning

ENTERING THE PROGRAMMING MODE

To enter the **PROGRAM** mode, start with the radio powered off and press and hold the **SCAN** button and **PTT** button simultaneously while you power the radio on; done by pressing the **MODE** button for 3 seconds. The radio will beep and display all the LCD segments for a few seconds. The Program icon (shown by PROG) will appear, the channel number flashes, and the Frequency icon (shown by **FREQ**) and Privacy Code icon (shown by **CODE**) will be displayed alternately.

To exit **PROGRAM** mode, press the **MODE** button for 3 seconds then the unit will power off.

SELECTING A CHANNEL

In the PROGRAM mode, press the **MODE** button until the CHANNEL icon flashes (this is the default setting when in Program mode).

Press the ▲\▼ button to select from the 4 available channel numbers. Press the **MODE** button again to continue programming.

PROGRAMMING THE FREQUENCY

In the PROGRAM mode, press the **MODE** button until the FREQ icon appears and the Frequency Code flashes.

Press the ▲\▼ button to select from the 56 available Frequency numbers.

Press the **MODE** button again to continue programming.

PROGRAMMING THE PRIVACY CODES

Your BR777 has 121 **Privacy Codes** available. The selected **Privacy Code** may be different for each channel.

In the PROGRAM mode, press the **MODE** button until the CODE icon appears and the Privacy Code flashes.

Press the ▲\▼ button to select from the 121 available Privacy Code numbers.

Press the **MODE** button again to continue programming.

- Note** : *Selecting a Privacy Code of "0" will disable the Privacy feature. To communicate between two BR777 radios, all radios in your group must be set to the same Channel, Frequency and*
- *Privacy Code selections.*

EDITING THE SCAN LIST

You can edit the SCAN List to skip channels during scanning.

In the PROGRAM mode, press the **MODE** button until the display shows an “**S**” on the left side of the display and a “**y**” or “**n**” icon flashing on the right of the channel number.

Press the ▲\▼ button to select “**y**” or “**n**”.

If you select “**y**” on any channel, it means it will be included on the SCAN List.

If you select “**n**” on any channel, it means it will be excluded on the SCAN List.

Press the **MODE** button again to continue programming.

PROGRAMMING CALL ALERT OR VIBRATE ALERT

Your BR777 radio has 3 selectable CALL Alert tones, so you can alert the other radios that you need to communicate with them. Your radio is programmed with the Call Alert turned off (set to 0), but you can change this setting and choose among the 3 available tones.

Your BR777 radio also has a **VIBRATE Alert** function. This will enable you to alert the other radios by vibration instead of a Call Alert sound for a more silent operation.

Select Call Alert Tone 4 to turn the **VIBRATE Alert** on. The VIBRATE Alert icon  will be displayed on the LCD when the VIBRATE Alert function is on.

In the PROGRAM mode, press the **MODE** button until the CALL Alert icon (shown as “**CA**”) appears on the left, and on the right the current Call Alert setting is shown.

Press the ▲\▼ button to hear and select from the 1~3 available CALL Alert tones. Select CALL Alert tone 4 to choose the VIBRATE Alert function.

Press the **MODE** button again to continue programming.



Note : To transmit a Call Alert tone or Vibrate Alert, press the **SCAN** button twice rapidly.

PROGRAMMING THE VOX (HANDS-FREE TRANSMISSION)

Your BR777 radio has 3 VOX level settings (**oF/1/2/3**).

In the PROGRAM mode, press the **MODE** button until the “**VOX**” icon appears while the current VOX setting appears on the right.

Press the ▲\▼ button to select between “**0**”, “**1**”, “**2**”, or “**3**” VOX setting.

Press the **MODE** button again to continue programming.



Note : **VOX** will be more sensitive on the “**1**” setting than on the “**3**” setting. Selecting “**0**” will disable the VOX function, and the VOX icon will not appear on the display during operating.

CLONING THE RADIO SETTINGS

You can copy the BR777 radio settings from one radio (**SOURCE**) to another BR777 radio (**TARGET**) by using a Cloning Cable.

Note to start the Cloning Process without the Cloning Cable attached to the radios.

To clone the radios:

- Set both the SOURCE and TARGET radio into PROGRAM mode.
- Press the **MODE** button of both radios until the CLONE icon (shown as “**CLON**”) appears on the right, and below a “**CL**” is shown.
- Press the ▼ button of the TARGET radio and the RX icon will appear.
- Press the ▲ button of the SOURCE radio and the TX icon will appear.
- **Attach the Cloning Cable on both radios.**
- Press again the ▼ button of the TARGET radio and you will see 4 segments blinking in sequence in the LCD display.
- Press again the ▲ button of the SOURCE radio and you will see 4 segments blinking in sequence in the LCD display.
- Once the cloning process is done, a “**P**” will appear on the display.
- Remove the cloning cable from the radios.
- Exit the cloning process by pressing the **MODE** button for more than 3 seconds until the unit is powered off.

KEYPAD LOCK

To avoid accidentally changing the radio setting, press the **LOCK** button for more than 3 seconds. The **KEY LOCK** icon will appear on the display. **PTT** and **CALL** will still be active. Repeat the same procedure to unlock the keypad.

EXTERNAL SPEAKER/MICROPHONE JACK

Your BR777 Series can be used with an optional external speaker/microphone or headset, freeing your hands for other tasks. To use an optional speaker / microphone or headset:

- Insert the plug(s) into the **SPK/MIC** jack.
- Place the earbud into your ear, and adjust the mic into your desired position.

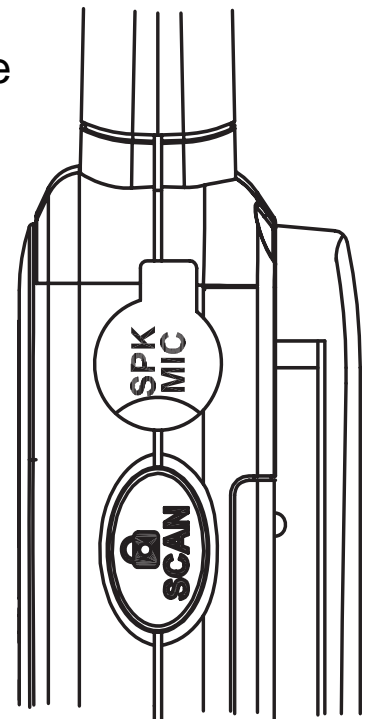

TROUBLESHOOTING GUIDE

PROBLEM	SOLUTION
No Power	- Check battery installation and/or replace batteries
Cannot Receive Messages	- Confirm the radios have the same channel and Privacy Code settings. - Make sure that you are within range of the other transceivers. - Buildings and other structures may interfere with your communication.
Radio is not responding to button presses	- Make sure key lock is not on. See "Keypad Lock" (Page 17). - Radio might need to be reset. Turn radio off then on. - Ensure accessory microphone is set properly
Display is dim	- Recharge or replace batteries.
Charger not functioning	- Contacts on the bottom of the radio may require cleaning. - Ensure the outlet where the charger is plugged into is functioning properly. - Check that the battery pack is installed in the radio properly.

USE AND CARE

1. Use a soft damp cloth to clean the radio
2. **Do not** use alcohol or cleaning solutions to clean the radio.
3. **Do not** immerse the radio in water.
4. Dry the radio with dry lint-free cloth should it get wet.
5. Turn off the radio and remove the batteries during long-term storage.

If you have a problem which you believe requires service, please call Blue Star customer service at 1-800-630-4684 and speak with a service technician first. Many problems can be remedied over the phone without returning the unit for service.

SPECIFICATIONS

Channels 4 Channels (56 Frequencies) + 121 Privacy Codes
Operating Frequency UHF 461.0375 ~ 469.5625 MHz
Power Source 3.7Vdc Li-ion Battery Pack

FREQUENCY CHART (MHz)

Display	FREQUENCY (MHz)	Display	FREQUENCY (MHz)	Display	FREQUENCY (MHz)
1	464.5000	20	461.3125	39	466.1625
2	464.5500	21	461.3375	40	466.1875
3	467.7625	22	461.3625	41	466.2125
4	467.8125	23	462.7625	42	466.2375
5	467.8500	24	462.7875	43	466.2625
6	467.8750	25	462.8125	44	466.2875
7	467.9000	26	462.8375	45	466.3125
8	467.9250	27	462.8625	46	466.3375
9	461.0375	28	462.8875	47	466.3625
10	461.0625	29	462.9125	48	467.7875
11	461.0875	30	464.4875	49	467.8375
12	461.1125	31	464.5125	50	467.8625
13	461.1375	32	464.5375	51	467.8875
14	461.1625	33	464.5625	52	467.9125
15	461.1875	34	466.0375	53	469.4875
16	461.2125	35	466.0625	54	469.5125
17	461.2375	36	466.0875	55	469.5375
18	461.2625	37	466.1125	56	469.5625
19	461.2875	38	466.1375		

PRIVACY CODE CHART (ANALOG)

Display Number	Frequency (Hz)	Display Number	Frequency (Hz)
1	67.0	20	131.8
2	71.9	21	136.5
3	74.4	22	141.3
4	77.0	23	146.2
5	79.7	24	151.4
6	82.5	25	156.7
7	85.4	26	162.2
8	88.5	27	167.9
9	91.5	28	173.8
10	94.8	29	179.9
11	97.4	30	186.2
12	100.0	31	192.8
13	103.5	32	203.5
14	107.2	33	210.7
15	110.9	34	218.1
16	114.8	35	225.7
17	118.8	36	233.6
18	123.0	37	241.8
19	127.3	38	250.3

Note: Privacy codes can be programmed for use on any channel

PRIVACY CODE CHART (DIGITAL)

Display Number	Digital Code	Display Number	Digital Code	Display Number	Digital Code
39	023	67	174	95	445
40	025	68	205	96	464
41	026	69	223	97	465
42	031	70	226	98	466
43	032	71	243	99	503
44	043	72	244	100	506
45	047	73	245	101	516
46	051	74	251	102	532
47	054	75	261	103	546
48	065	76	263	104	565
49	071	77	265	105	606
50	072	78	271	106	612
51	073	79	306	107	624
52	074	80	311	108	627
53	114	81	315	109	631
54	115	82	331	110	632
55	116	83	343	111	654
56	125	84	346	112	662
57	131	85	351	113	664
58	132	86	364	114	703
59	134	87	365	115	712
60	143	88	371	116	723
61	152	89	411	117	731
62	155	90	412	118	732
63	156	91	413	119	734
64	162	92	423	120	743
65	165	93	431	121	754
66	172	94	432		

Note: Privacy codes can be programmed for use on any channel

LIMITED WARRANTY

Blue Star will repair or replace, at its option without charge, any Blue Star by Midland BR777 transceiver which fails due to a defect in material or workmanship within Two Years following the initial consumer purchase. This warranty does not apply to water damage, battery leak or abuse.

Accessories have a 90 day warranty from date of purchase, including any antennas, chargers, or earphones. This warranty does not include the cost of labor for removal or re-installation of the product in a vehicle or other mounting. Performance of any obligation under this warranty may be obtained by returning the warranted product, prepaid freight, along with proof of purchase to:

**Blue Star
Customer Service
12410 W 62nd Terrace
Shawnee, KS 66216**

This warranty gives you specific legal rights, and you may also have other rights, which vary from state to state.

Note : The above warranty applies only to merchandise purchased in the United States of America or any of the territories or possessions thereof, or from a U.S. Military exchange.

**Blue Star
Customer Service
12410 W 62nd Terrace
Shawnee, KS 66216
URL: www.bluestarcomm.net**

ACCESSORIES

Accessories can be purchased at www.bluestarcomm.net or call **1-800-630-4684**.

BRC501



- 1 Dual Desk Charger
- 1 AC Adapter

BATT7L



- 1 Li-ion Battery Pack

BA100



- 1 Replacement Belt Clip w/ screw

BA300



- 1 Swivel Holster

BA700



- 1 Cloning Cable



Customer Service: 12410 W 62nd Terrace Shawnee, KS 66216

Note: Features & Specifications are subject to change without notice. MIDLAND and BLUE STAR are not responsible for unintentional errors or omissions on its packaging.

BLUE STAR by MIDLAND

BR777 PROGRAMMING QUICK REFERENCE GUIDE



To enter the **PROGRAM** mode, start with the radio powered off and press and hold the **SCAN** button and **PTT** button simultaneously while you power the radio on; done by pressing the **MODE** button for 3 seconds. The radio will beep and display all the LCD segments for a few seconds. The Program icon (shown by **PROG**) icon will appear, the channel number flashes, and the Frequency icon (shown by **FREQ**) and Privacy Code icon (shown by **CODE**) will be displayed alternately.

To exit **PROGRAM** mode, press the **MODE** button for 3 seconds then the unit will power off.

Setting the Channel

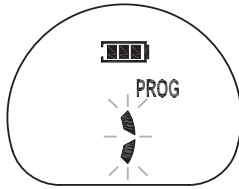

- Press the ▲ or ▼ button.

Setting the Frequency

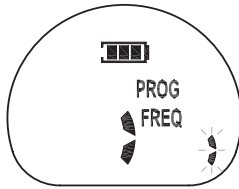

- Press the  button until **FREQ** appears.
- Press the ▲ or ▼ button to change the frequency.

Setting the Privacy Code

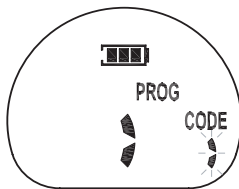

- Press the  button until **CODE** appears.
- Press the ▲ or ▼ button to change the Privacy Code.

Setting the SCAN List



- Press the  button until “y” appears.
- Press the ▲ or ▼ button to select between “y” or “n”.
- Selecting “y” will include the channel during scanning.
- Selecting “n” will exclude the channel during scanning.

BLUE STAR by MIDLAND

BR777 PROGRAMMING QUICK REFERENCE GUIDE



Setting the Call Alert/ Vibrate Alert

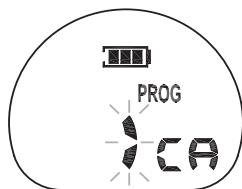

- Press the button until “CA” appears.
- Press the ▲ or ▼ button to select the Call Alert tone between 0~4.
- Selecting “0” will disable the Call Alert function.
- Selecting “1~3” will set the Call Alert tones.
- Selecting “4” will disable the Call Alert and enable the Vibrate Alert. The Vibrate Alert icon will appear on the display.

Setting the VOX

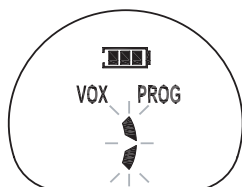

- Press the button until “VOX” appears.
- Press the ▲ or ▼ button to set the VOX level.

Cloning the Radio setting



Start this process without the Cloning Cable attached to the radios.

- Set both radios to Program mode.
- Press the button until “CL” appears on both radios.
- Press the ▼ button on Target radio. RX will appear.
- Press the ▲ button on Source radio. TX will appear.
- **Connect the Cloning Cable.**
- Press again the ▼ button on Target radio.
- Press again the ▲ button on Source radio.
- “P” will appear on the display when Cloning is finished.
- Remove the Cloning Cable and turn off the radios.