

## Table of Contents

Main features .....	2
Technical specifications of Midland BTX1 .....	2
Charging batteries .....	2
Unit and mounting system description .....	3
Switching your Midland BTX1 on and off .....	4
Operative "mode" .....	4
How to pair two BTX1 units .....	5
Talk 2 All - Pairing to a different brand intercom .....	6
Pairing the BTX1 to Bluetooth devices .....	6
How to use the wired audio input .....	8
Using a GMRS transceiver with the cable connection .....	8
Setup and special configurations .....	9
Setup and Firmware update .....	10
Use at your own risk .....	10
Warranty .....	10
FCC Compliance Information .....	11

# MIDLAND BTX1

## Basic Intercom System

*BTX1 is an intercom communication system solution for motorcyclists. The design is very slim and aerodynamic, all the main functions are easy to operate thanks to the three big buttons placed on the front of the unit.*

*BTX1 is mounted on the helmet using the adhesive plate or the screw mounting clamp. Thanks to the audio kit with ultra slim speakers, you can enjoy high quality stereo music while riding.*

## Main features

- › Intercom driver - passenger (30 ft).
- › Connect your phone to receive/place phone calls and listen to stereo music
- › Connect your GPS for turn by turn directions
- › AUX wired connection for MP3 player and GMRS radio
- › Setup and Firmware update via USB connection to a PC

## Midland BTX1 is available in two versions:

- › Single BTX1 Intercom kit with one unit only
- › Twin BTX1 Intercom kit with two units

**Depending on the model purchased, the package contains the following parts:**

### BTX1 single

- › 1 BTX1 communication unit
- › 1 audio kit with two stereo speakers, microphone with boom and wired microphone
- › 1 plate with bi-adhesive strip to mount the unit onto the helmet
- › 1 clamp to mount the unit onto the helmet
- › 1 mini USB wall-mounting power supply

### BTX1 Twin

- › 2 BTX1 communication units
- › 2 audio kits with two stereo speakers, microphone with boom and wired microphone
- › 2 plates with bi-adhesive strip to mount the unit onto the helmet
- › 2 clamps to mount the unit onto the helmet
- › 1 mini USB wall-mounting power supply with double plug

*The units included in the TWIN kit are already paired and can therefore be immediately used in Intercom mode.*

## Technical specifications of Midland BTX1

### General:

- › **Bluetooth ver. 3.0** stereo (Headset/Handsfree/A2DP protocol)
- › AGC system automatically controls the volume in relation to background noise
- › Voice (VOX) or manual communications activation
- › Manual controls to enable: telephone, intercom and wire connection
- › Fully waterproof
- › Lithium battery with 10 hours talk time
- › Recharge time: app. 6 hours

### Bluetooth connections:

With identical device for Driver to Passenger intercom

### Bluetooth devices:

- › Mobile phone with MP3 player Stereo (A2DP protocol), GPS (Garmin Zumo and TomTom Rider 1 and 2)

### Wire connections:

- › For stereo audio input like iPod/MP3 player (with optional cable)
- › For GMRS transceivers (with optional cable)

**Attention:** *Midland BTX1 is designed to withstand rain and water. However, if it is raining, always verify that the rubber caps protecting the sockets are fully fitted.*

## Charging batteries

**Attention:** *Make sure that the unit is fully charged before use. Allow at least 8 hours for a full charge before using the unit for the first time.*

Charge the unit by inserting the wall-charger into the charging socket (lift the rubber cover to insert the plug).

The red LED on the unit will start flashing when charging begins.

Allow the headset to charge until the unit stops flashing or the blue LED turns on.

When the charge is complete (the red LED is not flashing), release the headset from the charger.

Normally, after the first time, it takes 6 hours for a full charge.

**Attention:** every time the mini USB recharging plug is inserted (or detached), the device is automatically turned off. To use it while it is in charge, you should turn the device on with the plug already inserted.

## Unit and mounting system description

### BTX1 description

The BTX1 has five buttons on the front; the main three big button are multi functions buttons: the Forward (on the left), the middle button and the Rear (on the right), the two small rounded buttons are the Volume + and Volume -.

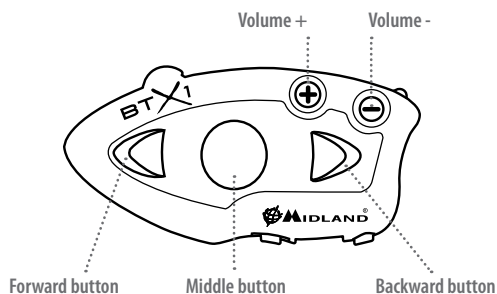

### Description of the wired connections

On the bottom of the unit you can find three wired connections:

**Charger jack:** recharges the unit using a standard mini USB power supply

**Audio kit jack:** connects an audio kit (stereo headset and microphone)

**Auxiliary audio jack (AUX) 2.5mm:** can be used to connect an audio source, like a stereo iPod/MP3 player or GMRS transceiver

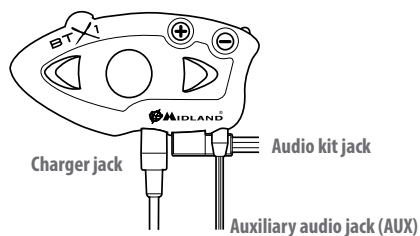

### Description of the audio kit

The audio system includes two ultra-flat stereo speakers and two interchangeable microphones, which are both supplied with a bracket and wired connection.

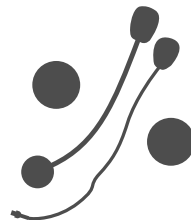

### Mounting the stereo speakers

The two stereo speakers have a Velcro/adhesive strip that aids their mounting into your helmet.

Beware not to completely cover your ear with the speakers, you must always be able to listen to the traffic sound and your indicators.

The microphone can be mounted onto the helmet in two ways:

### Boom Microphone

Place the section with the Velcro/adhesive strip between the padding and the rigid cover of the helmet so that the microphone is correctly positioned in front of your mouth and that the white symbol is facing your mouth. This type of microphone is suited for Open Faced and Flip Front helmets.



### Wired microphone

Using the Velcro/adhesive strip, place the microphone inside the helmet in front of your mouth. This type of microphone is more suited for Full Faced helmets. The mini connector on the microphone allows you to choose the microphone that best suits the helmet you are using.



### Audio kit jack

The audio kit must then be connected to the central jack of the Midland BTX1 unit using the "L" shaped connector.

## Description of the installation brackets

The Midland BTX1 can be mounted onto the helmet in two different ways: By either using the plate with bi-adhesive strip, or the clamp. These methods allow you to safely “mount” the BTX1 unit onto your helmet and to remove it at any time in order to recharge or store it.

### Plate with bi-adhesive strip

The mounting plate has a bi-adhesive strip on one of its sides. To mount the plate in place, clean the application area on the helmet surface, remove the bi-adhesive film and place the mounting plate on the helmet by applying pressure for a few seconds to ensure it bonds with the helmet's surface.



### Screw Clamp

Using the Allen Key, loosen the two screws on the clamp and place the rear plate between the helmet padding and the external rigid protection. Then, tighten the two screws in order to firmly mount the clamp in place. Inside the clamp is a small plastic spacer that can be removed to give a tighter fit if required.

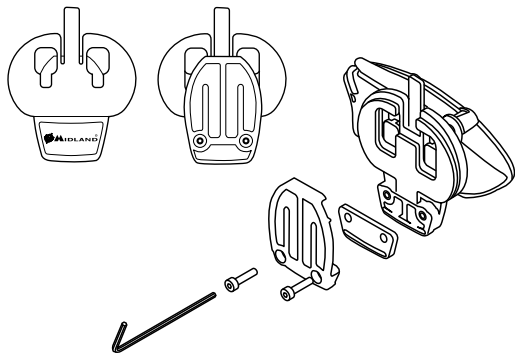

### Fitting and removing your Midland BTX1

The BTX1 can be easily fitted onto the helmet by sliding it downwards so that it fits into the slot of the selected mounting device (plate with bi-adhesive strip or clamp). The BTX1 is held in place by the mounting clip located on the upper section (A).

To detach the BTX1, simply press the mounting clip and push the unit upwards.

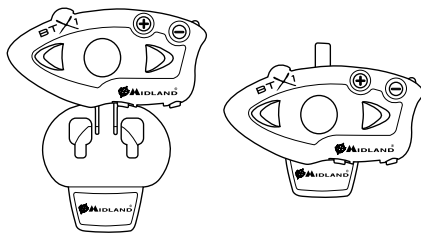

## Switching your Midland BTX1 on and off

### Switching the unit on:

Press and hold “Middle” button down for approximately 3 seconds until the BLUE indicator lights.

### Switching the unit off:

Press and hold both “Middle” and “Rear” buttons together for approximately 3 seconds until the RED indicator flashes 3 times, thus lessening the chances that you might turn off the unit accidentally (especially whilst wearing gloves).

## Operative “mode”

The BTX1 can operate in two main “modes”: Intercom and Phone.

The 3 multi function buttons can have different functionality depending on which mode the unit is in at that moment.

- > In “**Intercom mode**” the middle buttons let you manage the communications between driver and passenger
- > In “**Phone mode**” you can manage your Bluetooth cellular phone to place/answer a phone call or to listen to music (in stereo mode). Please use your phone responsibly and safely.

You can switch (toggle) from one mode to the other simply pressing the Middle button for 3 seconds. A voice announcement will tell in which mode you are operating in.

The toggle sequence is the following:

- > **Intercom mode** (if another unit has been paired)
- > **Phone mode** (if a phone has been paired)

Every time you turn on the unit, the default mode is Intercom (if it was previously paired to another unit), otherwise it will be Phone (If it was paired to a phone).

If you need to know in which mode the unit currently is, just press the “Volume +” and “Volume -” button together. A voice announcement will tell you the current mode.

## How to pair two BTX1 units

The two units supplied in the same BTX1 box, are already paired and ready to use, which mean you don't need to perform this procedure. The units are already paired using the Middle button.

If the devices are not part of the same kit, or the units has been purchased separately, you need to first pair them in order to use them together.

### To pair the BTX1 to another BTX1 unit

To pair the BTX1 to another BTX1 unit, you must first enter the setup mode:

1. Turn off the unit
2. Press and hold down the middle button about 7 sec., until the Red light is on permanently.
3. Now press the Middle button for 3 seconds. The Blue and Red light will flash.
4. Do the same procedure on the other unit. When successfully paired, each unit will have the Blue light on for one second and than go back to the setup mode (Red light always on).
5. Now the pairing procedure is complete, you need to exit the setup mode before you can use the units.
6. Double click on the Middle button, the Red light will turn off and the Blue light will start flashing.

You can use now your BTX1.

## How to use the Intercom

To use the intercom feature, be sure both units are turned on and correctly paired together.

### Manual activation

Press the Middle button on one of the two units. Communication is enabled and remains active until you press again the middle button. The intercom needs a few seconds to activate. You will hear a beep tone when the intercom is open.

### Voice activation (VOX)

Simply start talking to open communications. Expect a few seconds delay. If there is no conversation the intercom will be closed after 40 seconds. If needed you can close the intercom manually without waiting 40 seconds (just press the

middle button).

If needed, you can temporarily disable the VOX feature simply by pressing the Backward button for 7 sec. Two audible beeps will advise you when the VOX is disabled. To turn the VOX on again, just press the same button, one beep sound will advise you that the VOX is now active (or just turn the unit off and on again).

## Adjusting the volume

Your Midland BTX1 uses AGC technology, which automatically adjusts the listening volume in relation to background noises.

However, it is also possible to manually adjust the volume by means of the "Volume +" and "Volume -" buttons.

**Attention:** *Volume can be adjusted only when an audio connection is active.*

**Attention:** *The volume buttons (Vol + and Vol -) cannot be used to adjust the volume of the wired audio source. The AGC system will automatically increase the volume on higher speed.*

## How to pair the BTX1 to Midland BT line units

The BTX1 is compatible with all the BT line unit from Midland. You can pair the BTX1 to a BT2, BT1 or BTX2 unit and the max distance of the intercom is defined from the lower possible.

To pair the BTX1 to another BT line unit, you must first enter the setup mode:

1. Turn off the unit
2. Press and hold down the Middle button about 7 sec., until the Red light is on permanently.
3. Now press the Middle button for 3 seconds. The Blue and Red light will flash.
4. Follow the procedure on the other unit's instruction manual (normally you can use the "Volume +" button on all the previous BT line units).
5. When successfully paired, each unit will have the Blue light on for one second and than go back to the setup mode (Red light always on).

Exit the setup mode from both units before you can use them: for BTX1 double click on the Middle button, the Red light will turn off and the Blue light will start flashing. For the other devices of BT line, please refer to their own user manual.

### A- Manual activation

Mode	Forward button	Middle button	Rear button
Intercom		<b>Short press:</b> Open/Close intercom to paired raider <b>Long press:</b> Change mode	<b>Long press:</b> Toggle on/off wired

## Talk 2 All - Pairing to a different brand intercom

Thanks to the “Talk2 All - Universal Intercom” feature, it is now possible to pair your BTX1 to a different brand intercom available on the market.

1. On the BTX1 enter the setup mode: (With the unit OFF press and hold down the Middle button about 7 sec., until the Red light is on permanently).
2. Press the “Forward” button for 3 seconds, the Red and Blue LED light will flash.
3. On the other intercom (not Midland brand) follow the procedure to pair to a phone.

When successfully paired (no red/blue flashing light), to open the intercom communication on the BTX1 follow the instruction “Manual activation”; on the other intercom just press the phone redial button.

**Attention:** When using this configuration, the other intercom (not Midland brand) will not be able to be paired to a phone.

## Pairing the BTX1 to Bluetooth devices

The BTX1 unit can be paired to other Bluetooth devices, like a Phone or GPS Navigator.

The pairing procedure must be done using the “Volume +” buttons.

- › **Pairing to the “Volume +” button:** for Phone or GPS. All devices paired to this button have higher priority and will interrupt all the other communication .

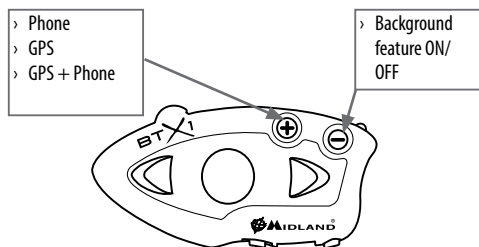

## Pairing to a phone

The cellular phone can be paired only to the “Volume +”, when the paired “phone mode” is active. In this way it is possible to manage all the phone functionalities and listen to the stereo music. An incoming phone call has the highest priority and will close all other communications (Intercom, Music).

## Pairing to a GPS navigator

The GPS can be paired on the “Volume +” button, when the paired “phone mode” is active.

**Attention:** If you need to connect both Phone and GPS, you must pair the Phone to the GPS itself.

## Bluetooth connection always in Background

This feature lets you keep the Bluetooth connection via the “Volume+” button present in the background when the Intercom is open (this allows GPS navigator announcements to be heard while the intercom is open).

### Enabling/Disabling the Background feature:

Press the “Volume -” button for 3 seconds. A voice announcement will tell you the status. The background feature is active by default.

## How to pair the BTX1 to a Phone

To pair the BTX1 to a Phone, you must first enter the setup mode:

1. Turn off the unit
2. Press and hold down the middle button about 7 sec., until the Red light is on permanently.
3. Now press for 3 seconds the “Volume +” button, the Blue and Red light will flash.
4. Enable the Bluetooth device search feature on your mobile phone
5. After a slight delay, “Midland BTX1” will be displayed on your mobile phone. Follow the pairing procedure of your Phone. If a pin code is requested you must enter “0000” (four time zero).

When successfully paired, the Blue light of the unit will be on for one second and then the unit will exit the setup mode and switch to the working mode (the Blue light will start flashing).

You can use now your BTX1 together with the Phone.

## How to use a Phone

In order to use all the phone/MP3 music player feature. If you are in “Intercom” mode you can only manage the incoming phone call. To activate the “phone” mode, press the middle button until you hear “Phone” from the voice announcement. Now all the three main buttons are dedicated to the phone (see Table B)

### Answering a call in both Phone/Intercom mode

When you hear the phone ring, you can answer in two different ways:

### Vocally:

Simply say one word to answer the call and start talking.  
Remembering that you can only do this if you answer the call after the third Ring.

**Attention:** Be aware that some phones may not support voice answering

### Manually:

Tap the "Forward" button and start speaking.

### Rejecting a call in both Phone/Intercom mode

If you don't wish to answer, you can let the mobile phone ring or press the "Forward" button for a few seconds (you will hear one audio confirmation tone).

### Making a call only in Phone mode

There are several ways to make a call.

#### From the mobile keypad:

Dial the number on the mobile keypad:  
Press "Send" on the mobile phone.

#### To redial the last number:

Press "Forward" button for 3 seconds in order to redial the last number (you will hear one audio confirmation tone).

#### To make a voice call:

Briefly press "Forward" button. If your mobile phone supports voice calls, you will be asked to speak the name of the contact you wish to call.

**Priority:** Calls have a high priority, which means that all other communications are temporarily disabled when a call arrives and automatically re-enabled once the call ends.

### Ending a call in Phone/Intercom mode

There are several ways to end a call:

- › Wait for the called person to end the call.
- › Press the "Forward" button (you will hear an audio confirmation tone).
- › Press "End" button on the mobile phone.

### Using the MP3 player feature of the mobile phone only in Phone mode

Many mobile phones are now designed to be used as stereo MP3 players. The BTX1 device fully supports the A2DP and AVRCP protocols that enable you to listen to stereo music and remotely control your mobile phone's MP3 player. You can even use the buttons on the BTX1 unit to control the following play options: Play, Pause, Forward and Backward.

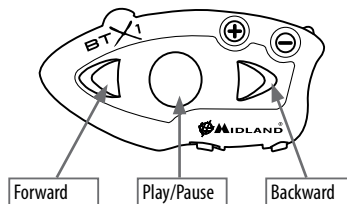

### Available controls:

- › To play/pause music: click on the "Middle" button.
- › To skip forward to the next song: press the "Forward" button.
- › To skip backwards to the previous song: press the "Rear" button..

**Priority:** The music listening mode has the lowest priority. Therefore, it will always be disabled when another type of communication is enabled.

### How to pair the BTX1 to a GPS

In general, it is possible to pair the BTX1 to all GPS devices that support Bluetooth headset connections for motorbikes

To pair the BTX1 to a GPS, you must first enter the setup mode:

1. Turn off the unit
2. Press and hold down the "Middle" button about 7 sec., until the Red light is on permanently.
3. Now press firmly (3 sec) the "Volume +" button, the Blue and Red light will flash.

### B-Phone mode

Mode	Forward button	Middle button	Rear button
Phone	<b>Short press:</b> Voice dial /accept or close if it is in progress <b>Long press:</b> Redial last number/ or reject incoming call	<b>Long press:</b> Change mode	<b>Long press:</b> Toggle on/off wired
Phone (when music play)	<b>Short press:</b> Forward the song	<b>Short press:</b> Play/pause <b>Long press:</b> Change mode	<b>Short press:</b> Backward the song

4. Enable the Bluetooth device search feature on your GPS
5. After a slight delay, "Midland BTX1" will be displayed on your GPS.
6. Follow the pairing procedure of your GPS. If a pin code is requested, you must enter "0000" (four times zero).
7. When successfully paired, the Blue light of the unit will be on for one second and then the unit will exit the setup mode and switch to the working mode (the Blue light will start flashing).

When you pair the GPS to the Volume + button, you lose the ability to pair the phone to the BTX1 unit. You can overcome this limit by pairing the phone directly to the GPS and then the GPS to the BTX1 unit. All the phone features are therefore managed by the GPS itself.

### GPS navigator always in background

To keep the intercom open while the GPS give the street indication, you must have the "background" feature active.

## How to use the wired audio input

Your Midland BTX1 is also supplied with a wired audio input (AUX), that can be used to connect an audio source, like an iPod (or any other MP3 Player) or a GMRS transceiver for group communication or for a coverage increase.

### Listening to music

To listen to music from the wired input, connect the audio source using the optional AUX cable.

The volume buttons (Vol + and Vol -) cannot be used to adjust the volume of the wired audio source. The AGC system will automatically increase the volume on higher speed.

**Attention:** Never set the volume of the MP3 Player to the maximum possible. Normally the best level is about the 70% of the maximum.

**Hint:** We recommend that you perform a few tests adjusting the volume of your iPod/MP3 player so at the normal speed the Headset volume is suited to your needs. The AGC system will automatically increase the volume on higher speed. Make a note to remember this setting for future trips.

### Enabling/disabling the wired input

If needed the wired input can be enabled or disabled.

Enabling/Disabling: Make a Long press on the "Rear" button (you will hear one audio beep tone for enabling confirmation and two audio beep tone for disabling).

## Using a GMRS transceiver with the cable connection

In order to connect the transceiver to your Midland BTX1, you need to purchase the specific 2.5mm plug AUX cable, sold separately. Some manufacturers radios use a different pin configuration, so we recommend that you ask your dealer as to

which cable is best suited to your needs

The cable connected to the transceiver normally has also a PTT button that can be placed on the handlebar of your bike or held in your hand (If you are the passenger rider).

To communicate via the attached radio, press the PTT button to speak and release it to listen. It is not possible to talk and listen simultaneously.

Adjust the volume of the transceiver to your needs, remembering that the volume adjustment is controlled by the automatic AGC system and that it will therefore be automatically increased in relation to background noise.

If you wish to use a GMRS transceiver for group communications and simultaneously maintain the Intercom feature enabled between two or more BTX1 devices, you must remember that every time you talk to communicate with the GMRS transceiver (pressing the PTT button), you will also activate the intercom of the BTX1 to the unit connected to the "Middle" button (thanks to the VOX feature).

To avoid the Intercom activation when you speak on the GMRS, you can decide to pair the BTX1 unit on the "Rear" or "Forward" (where the VOX is not active) or if you still want to use the "Middle" button, you must disable the VOX feature, as explained in the previous section.

**Attention!** If you disable the VOX feature, you will only be able to answer incoming phone calls by pressing the "Forward" button.



## Setup and special configurations

### Resetting all paired devices

Sometimes you may find it necessary to delete all the pairing references stored in the BTX1 unit (reset operation).

To perform this operation you must first enter the setup mode:

- › Turn off the unit
- › Press and hold down the “Middle” button about 7 sec., until the Red light is on permanently.
- › Then simultaneously press and hold down the “Volume +” and “Volume –” buttons for 3 seconds. The Blue Light will be lit for 1 sec and then turn back to steady RED.
- › Double click on the “Middle” button to exit the “Setup” mode and use the BTX1. This procedure deletes all the paired Bluetooth devices stored in the memory and it is therefore possible to start a new “clean” pairing session.

### Back to factory setting

Sometimes you may find it necessary to go back to the factory setting, to reset all the changes/Setup already made and have a “clean” unit.

To perform this operation you must first enter the setup mode:

- › Turn off the unit
- › Press and hold down the “Middle” button about 7 sec., until the Red light is on permanently.
- › Then simultaneously press and hold down all the three buttons “Forward”-“Middle”-“Rear” for 3 seconds. The Blue Light will be lit for 1 sec and then turn back to steady RED.
- › Double click on the “Middle” button to exit the “Setup” mode and use the BTX1.

### Adjusting/ Disabling the VOX feature (Intercom and telephone)

The Intercom feature can be enabled both manually and vocally (VOX). The VOX activation is influenced by the background noise and therefore by the speed.

For optimum results, it is possible to choose one of the following four microphone sensitivity levels: high, medium, low and very low. The default setting of BTX1 is “low”. It is also possible to disable the VOX feature in order to activate the Intercom and phone call answering features in manual mode only.

### Adjusting the sensitivity of the microphone (VOX)

To perform this operation you must first enter the setup mode:

1. Turn off the unit
2. Press and hold down the “Middle” button about 7 sec., until the Red light is on permanently.
3. Your BTX1 is now in “Set up mode”.

4. Press the “Rear” button until the red light indicator changes to a steady blue.
5. Now, press “Volume +” or “Volume –” to increase or reduce sensitivity. Every time you press the Volume buttons the RED light will flash for confirmation. When you reach the end of the upper and lower limit, the RED light will not flash.
6. Press again the “Backward” button; the Blue light will flash several times, in order to let you know the selected sensitivity:  
One flash = VOX disabled  
Twice = very low sensitivity  
3 times = low sensitivity  
4 times = medium sensitivity  
5 times = high sensitivity  
The light indicator is now back to steady RED (“Set up mode”) and the changes are confirmed
7. If needed, you can adjust again the sensitivity repeating the steps from point 1, otherwise exit the Setting mode by double clicking the “Middle” button. Once the red light turns off, the blue led will start blinking. Now you can use your BTX1.

### Disabling the VOX feature (Intercom and telephone)

Follow all the procedure described in the previous steps and choose the option of only one flash (VOX disabled).

### Wired connection always in background

This feature lets you keep the wired connection always on, even when the phone or the intercom is open. This feature can be useful when you connect a GMR5 transceiver.

By default this option is on.

*Disabling:*

- › Enter the “Setup” mode:
- › Turn off the unit
- › Press and hold down the “Middle” button about 7 sec., until the Red light is on permanently.
- › Press the “Forward” and “Middle” button together for 3 seconds. The Blue LED will flash twice.
- › Double click on the “Middle” button to exit the “Setup” mode and use the BTX1.

*Enabling:*

Follow the same procedure described above; now the blue LED will flash once. To exit the “Setup” mode, double click the “Middle” button.

## Setup and Firmware update

It is possible to configure and update the firmware of your BTX1 using the USB connection to your PC. On the Midland web site [midlandusa.com](http://midlandusa.com) in the BTX1 page you can find the PC software and the new firmware updates if available.

ATTENTION DO NOT CONNECT THE UNIT TO THE PC BEFORE YOU DOWNLOAD AND INSTALL THE SOFTWARE

## Use at your own risk

The use of the device will impair your ability to hear other sounds and others around you.

Listening to music or speaking on a telephone may prevent you from hearing others around you and distract you from riding safely. The use of such device while riding may endanger you and others, and its use, in some areas, could not be allowed.

Using this device at a high volume may result in permanent hearing loss.

If you experience ringing in your ear or any other hearing related pain, reduce the volume or discontinue using this device. With continued use at high volume, your ears may become accustomed to the sound level, which may result in permanent damage to your hearing.

Please use this device at a safe volume level.

## LIMITED WARRANTY

### (United States and Canada)

Subject to the exclusions set forth below, Midland Radio Corporation will repair or replace, at its option without charge, any Midland Bluetooth Intercom which fails due to a defect in material or workmanship within Two Years following the initial consumer purchase.

This warranty does not apply to water damage, battery leak, abuse or misuse of unauthorized accessories, unauthorized service or modification or altered products. Accessories have a 90 day warranty from date of purchase, including any chargers, mounts, and cables.

This warranty does not include the cost of labor for removal or re-installation of the product in a vehicle or other mounting.

ANY IMPLIED WARRANTIES, INCLUDING, WITHOUT LIMITATION THE IMPLIED WARRANTIES OF MERCHANTABILITY AND FITNESS FOR A PARTICULAR PURPOSE, SHALL BE LIMITED AS SET FORTH HEREIN AND TO THE DURATION OF THE LIMITED WARRANTY, OTHERWISE THE REPAIR OR REPLACEMENT AS PROVIDED UNDER THIS EXPRESS LIMITED WARRANTY IS THE EXCLUSIVE REMEDY OF THE CONSUMER AND IS

PROVIDED IN LIEU OF ALL OTHER WARRANTIES, EXPRESS OR IMPLIED. IN NO EVENT SHALL MIDLAND BE LIABLE, WHETHER IN CONTRACT OR TORT (INCLUDING BUT NOT LIMITED TO NEGLIGENCE, GROSS NEGLIGENCE, BODILY INJURY, PROPERTY DAMAGE AND DEATH) FOR DAMAGES IN EXCESS OF THE PURCHASE PRICE OF THE PRODUCT OR ACCESSORY, OR FOR ANY INDIRECT, INCIDENTAL, SPECIAL OR CONSEQUENTIAL DAMAGES OF ANY KIND, OR LOSS OF REVENUE OR PROFITS, LOSS OF BUSINESS, LOSS OF INFORMATION OR DATA OR OTHER FINANCIAL LOSS ARISING OUT OF OR IN CONNECTION WITH THE ABILITY OR INABILITY TO USE THE PRODUCTS OR ACCESSORIES TO THE FULL EXTENT THESE DAMAGES MAY BE DISCLAIMED BY LAW.

For Product Purchased in the USA:

Performance of any obligation under this warranty may be obtained by returning the warranted product, prepaid freight, along with proof of purchase to:

Midland Radio Corporation  
Warranty Service Department  
5900 Parretta Drive  
Kansas City, MO 64120

This warranty gives you specific legal rights, and you may also have other rights, which vary from state to state.

Note: The above warranty applies only to merchandise purchased in the United States of America or any of the territories or possessions thereof, or from a U.S. Military exchange.

For Product Purchased in Canada:

Performance of any obligation under this warranty may be obtained by returning the warranted product, along with proof of purchase, to your place of purchase in Canada.

This warranty gives you specified legal rights. Additional warranty rights may be provided by law in some within Canada.

## FCC Compliance Information

This device complies with Part 15 of the FCC Rules. Operation is subject to the following two conditions: (1) this device may not cause harmful interference, and (2) this device must accept any interference received, including interference that may cause undesired operation.

You are cautioned that changes or modifications not expressly approved by the part responsible for compliance could void the user's authority to operate the equipment.

"This device complies with Industry Canada license-exempt RSS standard(s). Operation is subject to the following two conditions: (1) this device may not cause interference, and (2) this device must accept any interference, including interference that may cause undesired operation of the device."

"This equipment complies with Industry Canada radiation exposure limits set forth for an uncontrolled environment."

NOTE: This equipment has been tested and found to comply with the limits for a Class B digital device, pursuant to part 15 of the FCC Rules. These limits are designed to provide reasonable protection against harmful interference in a residential installation. This equipment generates, uses and can radiate radio frequency energy and, if not installed and used in accordance with the instructions, may cause harmful interference to radio communications. However, there is no guarantee that interference will not occur in a particular installation. If this equipment does cause harmful interference to radio or television reception, which can be determined by turning the equipment off and on, the user is encouraged to try to correct the interference by one or more of the following measures:

- » Reorient or relocate the receiving antenna.
- » Increase the separation between the equipment and receiver.
- » Connect the equipment into an outlet on a circuit different from that to which the receiver is connected.
- » Consult the dealer or an experienced radio/TV technician for help.



**2-Way Radios**



**Weather Radios**

 **Bluetooth®**



**Bluetooth Headsets**



**HD Wearable Video Cameras**



**Marine Radios**



**Emergency Crank Radios**



**CB Radios**

Check out these and other great products at  
[midlandusa.com](http://midlandusa.com)