

Improper use can damage the product and even cause injury. Please read this manual carefully and use it correctly. Save the manual. 

Folding PV Power Pack USE MANUAL

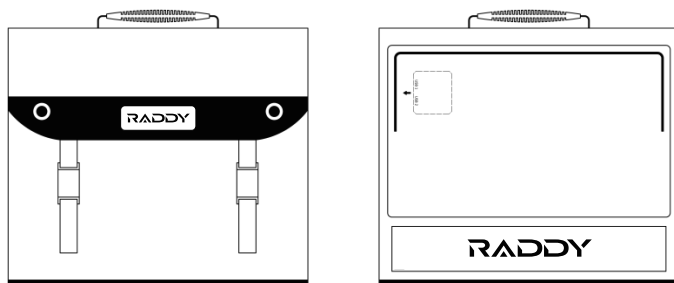

Specifications

Model NO.	SP120
Size (LxWxH-mm)	52cm×169cm×3.5cm (Expand Size)
	52cm×38cm×5cm (Folded Size)
product Weight	4.5 KG
Package Weight	5.5 KG
PV Power	120 W
Conversion efficiency	≥20%
DC	18V 6.5A (MAX)
USB	5V3A
Type-C	5V/3A, 9V/3A, 12V/3A, 19V/3AMax
QC3.0	5V/3A, 9V/2A, 12V/1.5A Max
Operating Temperature	-20℃~70℃

Main Function Description

1. Power generation package (Expanded view).

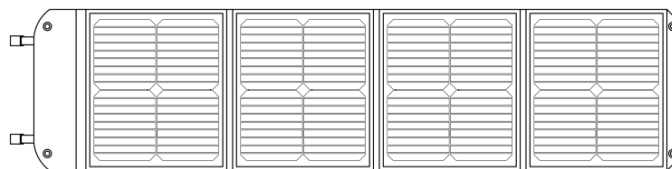

2. When generating electricity, put the solar cell surface under sunlight (as much as possible vertical exposure).

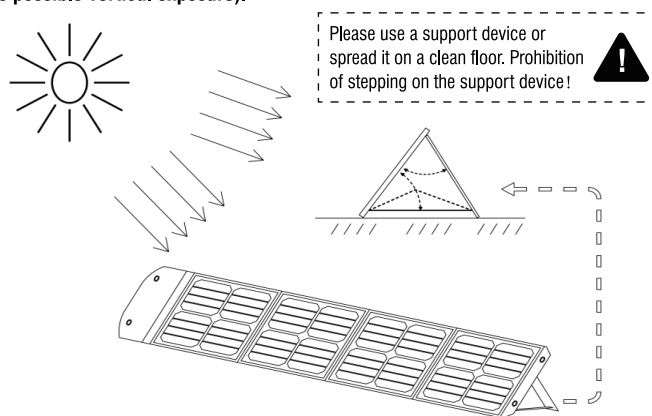

3. Output port

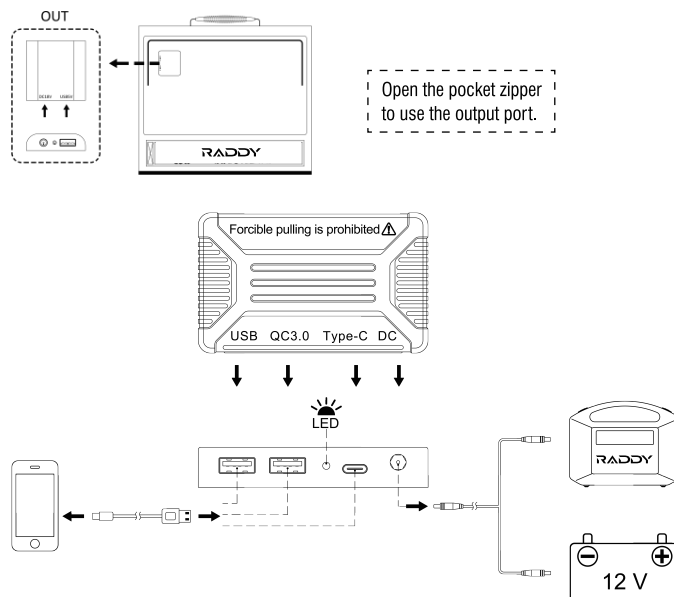

Product Accessories

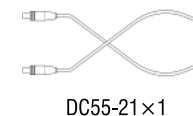

Attention

- ① It is forbidden to use in rainy days. Please keep away from high temperature environment when using(>70℃).
- ② When not in use for a long time, it should be stored in a dry and cool place.
- ③ Not washable. When cleaning, use water or alcohol to gently brush off the surface stains and dry naturally.
- ④ For oil contaminated places, neutral detergent and water can be used for local decontamination and cleaning treatment.
- ⑤ Unauthorized disassembly and modification of this product are prohibited to avoid damage.
- ⑥ When in use, lay it on a clean ground or use its own support device.
- ⑦ When improving power generation efficiency, let sunlight shine on the power generation surface as vertically as possible.
- ⑧ Forbid to short-circuit each output port.
- ⑨ The signs  in the manual are warning signs.
- ⑩ If you have any questions, please contact your dealer.

After-sales service and warranty

1. Quality guarantee period product: 1 year.
2. Free warranty rules:
 - ① Free warranty if use product properly and something is wrong during warranty period.
 - ② Once non-human factor accident occur during free warranty period, please contact the dealer or the company's after-sales department, mail the product and warranty card to them.
 - ③ Free gift has not warranty, the warranty of the lithium battery is 1 year.
 - ④ Customer is responsible for full cost of the repair, if the following conditions occur during warranty period:
 - Damage caused by actions which does not follow the instruction, unauthorized disassemble or modification.
 - Artificial damage including there is no purchase date and no dealer's record in the warranty card.
 - Damage caused by irresistible natural disasters such as floods, fires, earthquakes, lightning strokes, and wars.
 - Other circumstances not covered by the warranty, except home use (for long-term rental or long-term use on ships).

Product recommendations

It is recommended to buy RADDY series of outdoor energy products, product versatility is more guaranteed.

If you have any questions, please feel free to contact us by email via support@raddy.com

