

Thank you for your interest in our products. This manual will help you to master the operation and use of the GD-88. This manual should be read and studied to ensure that the user understands the operation of the GD-88. Please read the Safety Information Manual before use.

This manual applies to the model, GD-88 series digital handheld.

DISCLAIMER

We strive for the accuracy and completeness of this manual, but no warranty is given on its content. All the specifications and designs are subject to change without prior notice due to continuous technology development. No part of this manual may be copied, modified, translated or distributed in any form without our prior written authorization.

The third-party products referred to in this manual are property of those third parties. We do not guarantee their accuracy, validity, timeliness, legality or completeness.

USER NOTICES

SAFETY:

The user should be aware of and understand the general hazards in operating a two-way radio transceiver. We cannot guarantee the safety and operation of our transceiver with aftermarket accessories unless they have been tested and sold by us.

Our transceiver should be maintained and serviced by a qualified two-way radio dealer and their technical staff. Failure to do so may violate our warranty.

WARNING:

No two-way radio transceiver including ours shall be operated including powered on in hazardous areas such as explosive atmospheres including Inflammable gas, dust particles, metallic powders, grain dust, etc. This shall include confined spaces where these hazards exist, in areas where blasting or blasting products are in use or stored, and while fueling at refueling centers. In any of these conditions or where hazards exist, the transceiver shall be powered off.

PRECAUTIONS

Observe the following precautions to prevent fire, personal injury and transceiver damage.

- Do not modify or attempt to adjust this transceiver for any reason.
- Do not expose the transceiver to direct sunlight for long periods, nor place it close to a heat source.
- Do not place the transceiver in a dusty, humid or wet area, nor place on unstable surface.
- If an abnormal odor or smoke is detected coming from the transceiver, switch OFF immediately and remove the battery pack from the transceiver. Contact your dealer.

How to use this user manual

This manual introduces the basic operation of DMR / Analog handheld transceiver.

Your dealer or system administrator may have already preset the features of this radio based on your operational requirements. Please consult with your dealer or system administrator about the details.

The icons below are used for distinguishing between analog and digital features.



This icon indicates the function is only available in Analog mode.



This icon indicates the function is only available in Digital mode.



Notes:

When programming the radio, be sure to read out the original factory data first before changing desired relevant frequency, settings and other parameter values, otherwise it may result in incorrect set parameter values due to unmatched model or frequency band and other reasons.

CONTENTS

Packing list.....	4
Preparation for operating the radio	5
Charge the battery pack.....	5
Install the antenna.....	5
Install the battery pack.....	5
Install the belt clip.....	5
Install the audio accessories.....	5
Radio Controls.....	6
Parts description & function applications.....	6
Status Icons.....	8
LED indicators.....	10
Programmable Function keys.....	10
Keypads &ENC (Channel Selector) Operation..	11
Main functions description.....	12
3 x 4 Alphanumeric Keyboard operations.....	14
Transmit / Receive Icons.....	15

CONTENTS

Basic operations.....	15
Power On/Off the radio.....	15
Operating Frequency Band Selection.....	15
Volume Adjustment.....	15
Squelch.....	15
Busy Channel Lockout.....	16
Wide/ Narrow Band.....	16
CTCSS / DCS.....	16
Channel Selection.....	16
Switch between VFO and Channel Mode.....	16
VFO Frequency Set.....	16
Zone / Channel Selection.....	16
Monitor.....	17
Permanent monitoring.....	17
Repeater / Talk Around.....	17
Emergency Alarm.....	17
Man Down.....	18

CONTENTS

Scan On/Off.....	18
Roaming On / Off.....	18
Main menu contains item index.....	18
Menu accessing and operations.....	19
PTT Call.....	20
High / low power.....	20
Select the transmitting band.....	20
Receive and Answer to a radio call.....	20
Initiate a call.....	21
Initiate and receive calls in analog mode.....	21
Advanced functions for DMR.....	22
Menu functions operations.....	23
Contacts.....	23
Message.....	26
Call Log.....	28
Scan.....	30
Zones & Channel.....	34

CONTENTS

Local Set.....	35
Parameters.....	37
Tone Set.....	41
Appendix.....	42
Record.....	45
Device Info	46
User_defined Mode.....	46
Function Applications.....	49
General guide for fault handling.....	53
Maintenance and Clean.....	55

Packing list

The following items are contained in the gift box. If any item is missing or damaged, please contact your dealer.

Item Name	Quantity (pc)	Item Name	Quantity (pc)
Radio unit	1	Antenna	1
Battery pack	1	Belt clip	1
Charger	1	Hand strap	1
Power supply	1	User manual	1
Programming Cable	1		



AC Adaptor



Charger



Li-pol Battery 3000mAh



Belt clip



Antenna



Hand strap



Programming Cable

Note:

After purchase, please check the items and quantity in the box to ensure everything is correct.

Preparation for operating the radio

Charge the battery pack



When the battery is used for the first time, a low battery alarm may alert. Please turn it off and charge the battery firstly.

Note:

- Please use the designated battery pack and charging equipment for charging.
- Please refer to the charging safety information before charging to obtain the necessary battery safety information.

Please charge as follows:

1. Plug the power supply connector into the jack on the back of the charger.
2. Plug the charger power supply into a power outlet.
3. Install the battery or the radio with the battery into the charger.
4. Observe the charging LED indicators to know the current charging status:

Charger LED Indicators	Current Status
 Red	In Charging
 Green	Standby (No load) or Fully charged

Install the antenna

1. Screw the threaded end of the antenna into the top antenna port on the main unit.

2. Tighten the antenna clockwise.

 Do not hold the antenna with your hand, as this will reduce the radio performance.

Install the battery pack

Slide in the battery underneath the upper metal. Firmly push it down on its lower end. Close the Battery latch until you hear a "click" .

Note:

To remove the battery, turn off the radio, push the bottom battery button down, and then remove the battery in the backward direction.

Install the belt clip

1. Take out the belt clip and two screws from the equipped bag.
2. Align the belt clip mounting holes with the threaded holes on the main unit, insert screws, and tighten the screws to hold the belt clip.

Install the audio accessories

1. Open the dust cover of the accessory interface.
2. Insert the audio accessory plug into the accessory connector.

Radio Controls

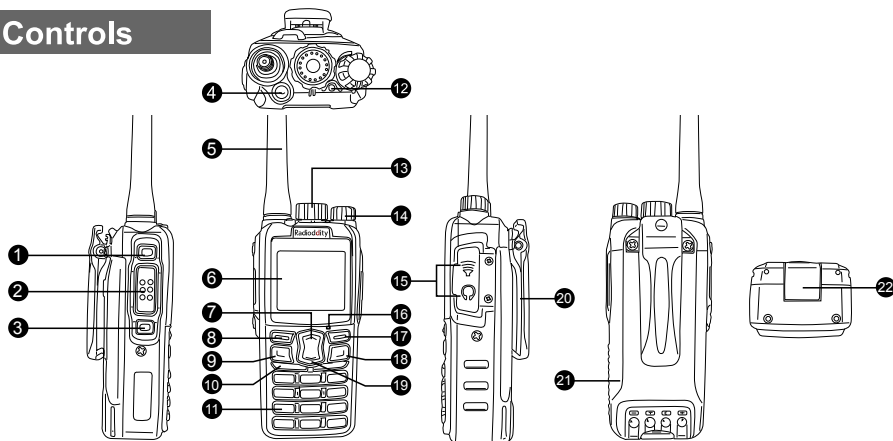

Parts description & function applications

NO.	Part Name	Function description and applications
①	PF1	Programmable function key 1
②	PTT button	Press PTT button to transmit and release it to receive
③	PF2	Programmable function key 2
④	PF3	Programmable function key 3
⑤	Antenna	Select the proper antenna according to the radio frequency band
⑥	TFT display	Display various working states, and combine with visual icons for easy use and operation;
⑦	UP key	Select the frequency, channel, menu, etc. up
⑧	Menu key / Select Key / OK Key	1). In standby, short press to access the menu of the current band; 2). In the current menu mode, short press to select the current menu item.
⑨	PF4	Programmable function key 4

NO.	Part Name	Function description and applications
⑩	Speaker	Used to receive audio from others
⑪	Numeric Keypad	Used to input frequency / channel number, alias, ID and SMS
⑫	LED indicator	Used to indicate the RX/TX status, etc.
⑬	Channel Selector	Operate the A/B band according to the CTRL display, and used to select channels, frequency bands, menus, etc.
⑭	Power switch/ Volume control	1). Turn on/off the radio. 2). Choose the proper volume level for use needs
⑮	SP/MIC jacket	For external accessories connection, such as earpiece
⑯	MIC	Speak to the microphone when pressing the PTT key to transmit; (3-5CM from the mouth)
⑰	CTRL (A/B band) selection Back key Edit key	1). In standby, short press to choose the desired A or B band (CTRL stays); 2). In menu operation, use as the return key; 3). In standby, long press to enter the set of the current band
⑱	A/B band TX selection Channel / VFO key	1). In standby, short press to choose the desired A or B band for transmitting.; 2). In standby, press long to switch between Channel Display and VFO mode for the current operating band
⑲	Down key	Select the frequency, channel, menu, etc. down
⑳	Belt Clip	Used to clamp the radio
㉑	Battery pack	Used to provide power to the radio
㉒	Battery latch	Used to fasten the battery to the radio unit.







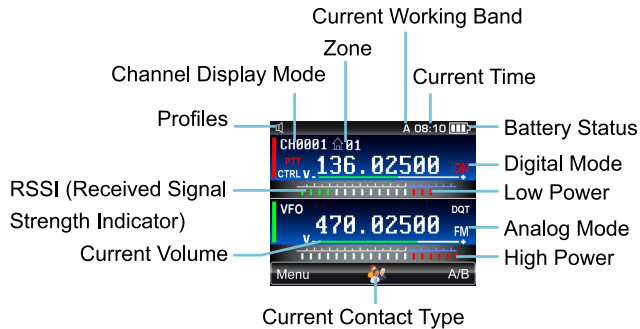





 **Note:**

For convenient use, there are programmable [PF] keys for definition.





TFT Statu Icons



Icon	Icon description	Applications and function description
	High Power	6 red bars indicate high power
	Low Power	3 red bars indicate low power
	Standby	White bars indicates the radio being in standby mode
	RSSI	In RX mode, the more green bars, the stronger signal
	Keylock	Appears when the keypad is locked
	Battery Status	The more bars, the larger battery capacity; and vice versa
	Monitor	Appears when monitor is on
	VOX	Appears when VOX is on
	GPS	Appears when GPS is on
	Scan	Appears when SCAN is on
	Emergency Mode	Appears when the radio is in emergency mode.
	Encryption	Appears when Encryption is on
QT	CTCSS	In analog mode, appears when CTCSS is on
DQT	CDCSS	In analog mode, appears when DCS is on









Icon	Icon description	Applications and function description
	Prompt Tone on	Appears when profile is in standard mode
	Prompt Tone Off	Appears when profile is in silent mode
	Talk Around	Appears when the radio is in Talk Around Mode
	Roaming	Appears when Roaming is on
	Roaming Lock	For locking current channel in Roaming
	Offset Frequency Negative direction	Appears when RX frequency is higher than TX frequency
	Offset Frequency Positive direction	Appears when TX frequency is higher than RX frequency
DN	Digital Mode	Indicates the current band working in digital mode
FM	Analog Mode	Indicates the current band working in analog mode
	Digital/Analog Mode	The current band is in digital/analog auto RX mode. Digital Mode is for main TX
	Analog/Digital Mode	The current band is in analog/digital auto RX mode. Analog Mode is for main TX
CTRL	Operating Band	Indicates that the current band is operable and settable
PTT	Band Transmitting	Indicates to transmit on the current band
	Time Slot 1	Indicates the working slot of current frequency or channel
	Time Slot 2	Indicates the working slot of current frequency or channel
	Zone	Indicates the working zone of current frequency or channel
VFO	Frequency Mode	Indicates working in frequency mode, can input frequency directly via numeric keypad
	SMS	Appears when received a new message.
A	Operating Band A	Appears when CTRL stays on A band
B	Operating Band B	Appears when CTRL stays on B band
A/R → B/T	AB Band Repeat Mode	Band A for receiving, and Band B for transmitting
A/TR ↔ B/TR	AB Band Repeat Mode	Band A or B for receiving and transferring thru Band A or B.
B/R → A/T	AB Band Repeat Mode	Band B for receiving and Band A for transferring.

LED Indicators

LED indicator	Radio Status
 Green	In receiving
 Red	In transmitting
 Fast Flashing Green	In scanning
 Slow Flashing Red	Low battery alert

Programmable Function keys



If desired, the following terminal features can be preset for programmable keys:

Type	Features	Description
	Radio Revive	Revive a target radio that has been remotely disabled
	Radio Detection	Determine if targeted radio is active
	Radio Kill	Disable targeted radio remotely
	Remote Monitor	Covert activation of targeted radios transmitter without local indicators.
	Encryption On/Off	Turn on/off encryption
	Emergency On/Off	Initiate an emergency alarm mode or call based on programmed preset.
	Record On/Off	Turn on/Off audio Record
	Contacts	Direct access to the contact list
	Relay On/Off	Turn On/Off A/B band Repeat mode
	Relay Monitor On/Off	Turn On/Off the speaker audio in the A/B band Repeat Mode
	Zone Switch	Changes from selected Zone to new Zone

Type	Features	Description
	Permanent Monitor	Always monitor the selected channel until disabled.
	Scan On/Off	Turn scanning on/off
	VOX On/Off	Switch between VOX On and Off.
	Backlight On/Off	Turn backlight On/Off
	Keypad Lock	Switch between keypad lock and unlock.
	High /Low Power	Switch transmit power between high and low power
	Man Down On/Off	Switch between Man Down alarm On and Off (Optional)
	Scan Mode	Select the desired scan mode (switch between SE, TO, CO mode)
	Repeat / Talk Around Selection	Switch between the Repeat and Talk Around Mode
	SMS	Direct access to SMS list
	Monitor	Turn On/Off the radio RX squelch circuit. Receive weak analog signals
	DTMF On/Off	Turn On/Off DTMF
	Roam-ON/OFF	Turn On/Off Roam
	GPS	Turn On/Off GPS
	1750Hz	Transmit 1750 signaling, which is used to activate analog relay channels

Keys & ENC (Channel Selector) operation

The following keys can be used to quickly achieve the desired function.

Keypad	Status	Operation	Description
MENU	Standby	Short Press	Access to the Menu
		[MENU]+[*] [Keylock] or [Unlock]	
	Long Press (3S)	Input the channel number and call up the desired channel.	
	Access to the Menu Mode	Short Press	[Confirm] or [Select]
BACK	Standby	Short Press	Select the operated Band A/B, where CTRL stays
		Long Press (3S)	Operations for Channel/VFO User-defined mode mode and storage and other parameters
	Menu Mode	Short Press	Back to the previous level
	Standby	Short Press	Select the Band A/B to transmit
		Long Press (3S)	Select Channel Display or VFO mode for current band (where CTRL stays)
	Menu Mode	Short Press	Exit the current operation mode
	In Any Status	Short Press	Preset function based on customization
	Standby	Long Press (3S)	Preset function based on customization

Keypad	Status	Operation	Description
UP Key	Standby	Short Press	Select the channel, frequency and other parameters up
		Long Press (3S)	When Scan is on: Scan channel / frequency up
	Access to the Menu Mode	Short Press	Select Menu and other setting parameters
	Enter User-defined mode	Short Press	Select programming items or other parameters;
	Edit (SMS)	Short Press	Move the editing position of the blink cursor to the left
DOWN Key	Standby	Short Press	Select the channel, frequency and other parameters down
		Long Press (3S)	When Scan is on: Scan channel / frequency down
	Access to the Menu Mode	Short Press	Select Menu and other setting parameters
	Enter User-defined mode	Short Press	Select programming items or other parameters;
	Edit (SMS)	Short Press	Move the editing position of the blink cursor to the right
Side key [PF1]	Standby	Short Press	Preset function based on customization
	Standby	Long Press (3S)	Preset function based on customization

Keypad	Status	Operation	Description
Side key [PF2]	Standby	Short Press	Preset function based on customization
	Standby	Long Press (3S)	Preset function based on customization
ENC	Standby	Rotate	Select channel, frequency and other parameters
	Access to the Menu Mode		Select Menu and other setting parameters
	Enter User-defined mode		Select programming items or other parameters;
	Edit (SMS)		Move the editing position of the blink cursor to the left or right
Top button [PF3]	Standby	Short Press	Preset function based on customization
	Standby	Long Press (3S)	Preset function based on customization

Main functions description

Classification	Function	Description
Public Functions	Zone	A zone is a group of channels. Support end users to build and expand zones by themselves.
	VFO Mode	In VFO mode, the user can directly input the required frequency through the numeric keyboard
	Channel	Support end users to build and expand channels by themselves, up to 4000 channels, 16 zones.
	A/B repeater	The radio can receive by either band A or B and then transfer by either band A or B
	A/B Repeat Interruption	In A/B Repeater Mode, the user can press PTT to insert a call
	A/B Monitor	In A/B Repeat mode, the user can preset Monitor On/Off in advance
	Man down	The tilt angle of the radio and time of duration are settable to start the alarm
	Power	The power level is for the transmission power level of the current channel, which can be set to high or low power.
	Emergent alarm	Emergency alarm has the highest priority.

Classification	Function	Description
Public Functions	Scan	When the terminal scans a signal on a channel, it will stay on the channel to listen, so as to understand the current activity status of the relevant team members.
	VOX	If VOX is on, when the voice is detected to reach the transmission condition by the microphone, it will be transmitted automatically. The user can Initiate a call without pressing the [PTT] key.
	Busy channel lockout	Busy channel lockout prohibits transmission and prevents interference to other users when the radio is receiving traffic.
	TOT	When a transmission times out, the terminal will automatically terminate the transmission and issue a warning sound. The user can Initiate a call without pressing the[PTT]key.
	Keyboard lock	Keyboard lock is used to lock keys to prevent inadvertent key operation. The radio may be set to automatic or manual lock mode.
	Power saving	Power saving is a preprogrammed function based on time that places radio into a sleep-wake mode to conserve the battery.

Classification	Function	Description
Digital functions	Private call	Private call is a one-to-one call.
	Group call	Group call is a one-to-many call.
	All call	All call is a call to all contacts on the current digital channel.
	Talk around	When the repeater fails to work or the radio exceeds the coverage of the repeater, it can communicate off-line (RX & TX at the same frequency) to communicate
	Roaming Setting	Roam Mode, RSSI Set, Connect Check Timer, Connect Re Check Timer, Connect Timer
	Roaming	When the radio moves from one site to another, it will automatically find the next available site through roaming.
	Recording	Can record any receive or transmit audio, or receive + transmit audio of the radio
Analog functions	TDMA direct mode	TDMA direct mode is used to divide a direct channel (simplex) into two time slots to allow efficient channel usage. Multiple parties may share the channel without interference depending on slot setting.
	DTMF RX / TX reminder	Used as the TX PTT prompt tone and RX prompt tone before receiving the voice.
	Analog channel call	An analog call is a call on an analog channel.

Classification	Function	Description
Analog functions	Narrow / Wide Band	Working band for the radio (Narrow band: 12.5KHz, Wide band: 25KHz)
	Squelch Level	It is the signal strength required to adjust the received signal. Normally the higher squelch level, the higher received signal strength is required. Settable squelch level is from 0 ~ 9. Level 0 is normally open, and there is background sound from the speaker once the radio is on. Level 9 is the highest and the required received signal strength is the strongest.
	Busy Channel Lockout	If it is ON, when received the carrier signal, it is prohibited to transmitting when pressing the PTT button.
	Monitor	Monitor allows the user to open the receiver squelch manually to listen to on-channel signals.
	CTCSS	CTCSS code for RX radio must be same as TX radio, so that the audio can be received successfully
	DCS	DCS code for RX radio must be same as TX radio, so that the audio can be received successfully

3 x 4 Alphanumeric Keyboard operation













The following buttons are used for the character selection.

Keystrokes

Keypad	1	2	3	4	5	6	7	8	9	10	11	12	13	14	15	16	17	18	19	20	21	22	23	24	25	26	27	28	29	30	Note	
	,	o	?	!	:	;	;	;	"	"	"	"	'	()	«	»														"PY" input mode	
	.	'	?	!	-	()	@	/	:	_	;	+	&	%	*	=	<	>	\$	[]	{	}	~	^	'	#	;	"AB" / "ab" input mode		
	A	B	C																													
	D	E	F																													
	G	H	I																													
	J	K	L																													
	M	N	O																													
	P	Q	R	S																												
	T	U	V																													
	W	X	Y	Z																												
																																Note: in the digital editing mode, a short press of this key enters the value of "0", while long press enters the symbol "+" in the digital, English and Chinese editing mode.
																																Note: in the digital, English and Chinese editing mode, a short press of this key enters the "" symbol, and a long press enters a "space".
																																Note: in the editing mode of Numbers, English and Chinese, a short press of this key inputs the symbol "#", while a long press switches between the editing input mode of English, Numbers, Chinese (pinyin) ("AB" in upper case, "ab" in lower case, "12" in figure, "PY" in Chinese pinyin)

Transmit / Receiving Icons

The following icon appears on the radio screen to indicate the radio status.

Mode	Type	ICON	Terminal product status
	Private call		Sending a private call
			Receiving an private call
	Group Call		Sending a group call
			Receiving an group call
	All Call		Sending an All Call
			Receiving an All Call
	—		Sending an analog transmission
			Receiving an analog transmission

Note:

In the contact list, user aliases, names, ID numbers, codes, etc can be used.

Basic operation

Power On/Off the radio

ON: Make sure the battery pack is fully charged and installed correctly, turn the [Power / Volume] knob clockwise until hearing a "click" sound. After power on, the brand logo and "is powering" character show on the display screen. At the same time, a power-on prompt tone (if turned on) is heard, and the LCD enters the standby interface.

OFF: Turn the [Power Switch / Volume Control] knob counterclockwise until hearing a "click", then the brand logo and "is powering" character show on the display screen.

Operating Frequency Band Selection

In standby mode, press the [A/B] key to switch to the Band A or B for operation and set. The current operable and settable band displays the "CTRL" on the upper left, and the "mode" indicating character color on the lower right changes from "white" to "red".

Volume Adjustment

When the "CTRL" displays at the upper left of Band A or B, turn the [Power / Volume] knob clockwise (increase) or counterclockwise (decrease) to adjust the volume of Band A or B. The green volume scroll bar below the current band will change according to the volume level.

Note:

The volume of band A or B is set separately.

Squelch

When the "CTRL" displays at the upper left of Band A or B, set the squelch level of the Band A or B separately by accessing the menu. In general, the higher squelch level, the received signal strength is stronger. Settable squelch level range is from "0, 1 ~ 9". Level 0 is normally open, and there is background

sound from the speaker once the radio is on. Level 9 is the highest and the required received signal strength is the strongest.

Busy Channel Lockout

When the "CTRL" displays at the upper left of Band A or B, set the Busy Channel Lock On/Off of the Band A or B separately by accessing the menu. If it is ON, when received the carrier signal, it is prohibited to transmitting when pressing the PTT button.

Wide/ Narrow Band

When the "CTRL" displays at the upper left of Band A or B, set the operating bandwidth of Band A or B separately by accessing the menu.

CTCSS / DCS

When the "CTRL" displays at the upper left of Band A or B, set the CTCSS and DCS signaling of Band A or B by accessing the menu or user-defined.

Channel Selection

The desired working channel can be selected by following two ways.

1. When the "CTRL" displays at the upper left of Band A or B, press the  key or rotate the [ENC] knob to select the channel of Band A or B.

2. When the "CTRL" displays at the upper left of Band A or B, press and hold the [MENU] key for 3 seconds, a dialog box and total channels of current zone pops up, to enter the desired channel number through the keyboard .

Switch between VFO and Channel Mode

In standby mode, when the "CTRL" displays at the upper left of Band A or B, press and hold the  key for 3 seconds, the current Band A or B switches between VFO and channel mode.

VFO Frequency Set

In standby mode, when the "CTRL" displays at the upper left of Band A or B, and the current band is in VFO mode, the desired frequency can be entered through the numeric keyboard. For example: 446.050000MHZ; directly input [4][4][6][0][5][0][0][0][0] through the numeric keyboard.

Note:

◇ The current frequency can be increased / decreased by pressing the  key or rotating the [ENC] knob.

◇ For detail user-defined operation steps, parameters set and storage, please refer to "VFO / Channel" on page 16.

Zone / Channel Selection

When the "CTRL" displays at the upper left of the current Band A or B, the following two methods can be used to select the

desired zone, channels switching and zone name modification or editing.

1. By presetting the programming key to [Zone Switching] feature.
2. Select [Zone] item by accessing the menu

 **Note:**

◇ For detail operation and steps, please refer to "Zone/Channel" on page 34.

 **Monitor** 

In standby mode or before pressing the [PTT] key to transmit, press and hold the preset [Monitor] key to monitor channel activity, or receive weak signals, or confirm whether the current channel is free.

 **Permanent monitoring** 

In standby mode, press the preset [Permanent Monitor] key to continuous monitor the current channel activity.

 **Repeater / Talk Around** 

When the repeater fails to work, or the radio exceeds the coverage of the repeater but within the call range of other radio users, press the preset [Repeater / Talk Around] key or set sub-menu "Timeslot/Repeater" thru Parameter in Menu to talk around actively and press [PTT] key to continue the communication. This is the so-called Talk Around.

 **Note:**

- ◇ This function is supported in digital mode only;
 - ◇ For detail operation and steps, please refer to "Timeslot / repeater" on page 38.
-

 **Emergency Alarm** 

The emergency alarm function is mainly used in an emergency situation. In any mode, press the preset [Emergency Alarm] key to initiate an Emergency Call.

◎ There are 3 Emergency Alarm modes supported:

- Emergency Alarm
- Emergency Alarm & Call
- Emergency Alarm & Voice

An alarm is a type of non-voice signaling that can trigger a prompt to another radio. This function refers to the alarm behavior of the radio after it is activated.

◎ The alarm has the following types:

- Disable - The radio can't send the alarm signal.
- Standard - The radio can send the alarm signal with voice & visual prompts.
- Mute - The radio sends alarm signaling without audio or visual prompts, and will not alert to any received audio.
- Mute with voice - The radio sends alarm signaling without audio or visual prompts, but can send signal to the eligible channels.

 **Note:**

- ◇ This feature is available in digital mode only.
-

Man Down



Preset the parameters of the radio Man Down feature, including the set of tilt angle, Start & Interval Time, Alarm Duration, Pre-alarm Time and other parameters. The radio will alarm automatically when the tilt angle and preset time are reached. The alarm will be automatically free if the radio is straightened. Press the preset [Man Down On/Off] key to turn on / off the Man Down.

Note:

◇ This feature is available only after parameters are preset in programming software.

Scan On/Off

When the "CTRL" displays at the upper left of the current Band A or B, turn on / off scan by the following three ways.

1. Turn on / off scan by programming [Scan On / Off] key.
2. Press and hold the [/] key for 3 seconds to turn on scan and press any key to turn off it.
3. Select the [Scan] item by accessing the menu to turn on/off it.

Roaming On / Off

If necessary, turn on / off roaming by the following two ways.

1. Turn on / off roaming by programming [Roaming on / off] key.
2. Select the submenu [Scan] item by accessing the menu to enable / disable roaming.

Note:

- ◇ Make sure the "Scan List" is pre-selected before turning on "Scan" or "Roaming" feature , otherwise, none of the scan types will be enabled.
 - ◇ The radio will work in Band A as default when "Roaming" is enabled.
 - ◇ When "Roaming" is enabled, the radio will start to scan all repeater channels in the "scan list" (TX/RX with inter-frequency), and the non-repeater channels in the "scan list" (RX/TX with same frequency) will not be scanned. If there is no repeater channel in the scan list, the radio will exit the roaming after scanning the current "scan list";
 - ◇ When "Scan" is enabled, the radio will open all the receivable channels in the "scan list".
 - ◇ For detailed setting and operation of the "Scan", please refer to page 30.
-

Main menu contains item index

Set various functions and parameters by accessing the main menu and submenu of the radio. The menu function options supported by this unit are shown in the table below. The user-defined [FP] programming keys are function shortcut keys, for specific function application, please pre-program by CPS, or consult the system administrator or local dealer.





No.	Icon	Main Menu Item	Available setting items
1		Contacts	Contact List, New contact, Manual Dial
2		Message	Create Msg, Comm Msg, Inbox, Outbox, Draft box.
3		Call log	Dialed Numbs, Received Calls, Missed Calls.
4		Scan	Scan (On/Off), Scan List, Scan Mode, Roam Scan
5		Zone&Channel	Zone List, Modify Name
6		Local Set	Language, Keypad lock, Back Light, LEDs, Display Mode, VOX, Channel Sw, Factory Reset, A/B Repeater
7		Parameters	TOT, Power, Repeat, Sleep Mode, SQ Level, Band, BCLO, Signaling, Enc Level
8		Tone Set	Profiles, Key Tone, Power Tone, Msg Tone, P Call Tone, G Call Tone, Alert Tone, Power On Tone.
9		Appendix	GPS(Optional), FM Radio, Time, DTMF (Optional), Speaker / Earpiece (Optional)
10		Record	Record Set, Record List, Clear Record, Space Info.
11		Device Info	Radio ID, RX Group List, CH contact, Version.

No.	Icon	Main Menu Item	Available setting items
12		User_defined Mode	Self-program the channel of current band(CTRL stays) or various parameters of VFO mode. Including: Mode selection, frequency, power, etc

Menu accessing and operations

Access the main menu and submenu options to set or browse various parameters (like message checking, editing and sending, etc) through the following operations and step. If there is access right preset by administrator or dealer, please contact them firstly.

Below icons may appear during menu accessing:

-  /  indicate On / Off selection;
-  /  indicate selected and executed items;
-  indicates to enter the next submenu option;

Processes:

1. In Standby Mode, press [MENU] key to access the menu.
 2. Press the [▲/▼] key to select the desired "Main Menu" item, and press the [MENU] key to enter.
 3. Press the [▲/▼] key to select the desired "Level 2 Menu" item, then press the [MENU] key to enter.
- If necessary, press [▲/▼] key to select the desired item and press the [MENU] key to enter.

OR

Press [▲/▼] key to select and set the current parameter value and press the [MENU] key to confirm and return to the previous level.

OR

Press the [MENU] key to select "On or Off".

4. Press the [BACK] key to return to the previous level.

OR

Press the [Red] key to exit the current menu operation, and return to the standby mode.

5. If needed, continue to browse other menus by repeat steps 2 ~ 4 or return to the "Main Menu" interface for other operation.

 **Note:**

◇ No matter the "CTRL" is displayed at Band A or B, the selecting and set for some menu parameters (public functions) work for both bands.

◇ For details please refer to "Main Functions Description" on page 12.

PTT Call

To ensure an optimal transmission, hold the radio in a vertical position at one to two inches (2.5 to 5.0 centimeters) away from the mouth.

High / low power

In standby mode, if needed, when the "CTRL" displays at the

upper left of the current band to be set, switch radio power by following two ways to extend the service time of the battery.

1. Press the preset [High / Low Power] key to switch between high and low power. The "red" indicator at the bottom of the screen of the current band will change according to the set power level.

2. Access "Power" through the menu to set the output power level of the radio. After setting, the "red" indicator at the bottom of the screen of the current band will change according to the set power level.

 **Note:**

◇ High power gets further communicate distance.

◇ Low power gets closer communication distance.

◇ Please refer to the operation of menu "Power" on page 38.







Select the transmitting band

In standby mode, press the [] key to switch between Band A and B for desired transmission, and the current transmitting band will have red "PTT" character displaying at the bottom left of the display screen.

Receive and Answer to a radio call

Private calls, Group calls, and All calls can be made to the preset contacts on the current digital channel (All call rights needs to be allowed by the dealer), and the methods for initiating and receiving all types of calls are the same. Each digital channel can be preset by the dealer with a "transmission

contact" for Private call, group call or call contact.

Call type	Operation method	
	Making call	Receiving call
Private call	In standby mode, press [PTT] key to initiate the call. When a call is initiated, the screen displays:  ;	When a private call received, the screen displays:  ;
Group call	When initiated a group call, the screen displays:  ;	When a group call received, the screen displays:  ;
All call	When Initiated an all call, the screen displays:  ;	When an all call received, the screen displays:  ;

Notes:

◇ If the "Tx Begin Tone" and "TX End Tone" for private and group calls are activated, when press [PTT] key to make a call, a short prompt tone will be heard indicating that the call is in progress. You can speak clearly into the MIC. And when release the [PTT] key, a short beep sound will be heard indicating that it is ready for receiving.

◇ If "Rx Begin Tone" and "Rx End Tone" for private and group calls are activated, when the other part press the [PTT] key to transmit, you will hear a short prompt tone indicating that the current channel is in receiving. And when the transmitter releases the [PTT] key, you will hear a short beep, indicating that the channel is idle and waiting for your answer.

◇ Please refer to the operation and steps of "Tone Set" on page 41.

Initiate a call



If necessary, a call can be initiated by any of the following ways.

1. Rotate the channel knob to select any preset channel, and then press the [PTT] key to call.
2. Access the "Contact" list through the menu, or press the pre-set "Contact" key to access the list. Select the desired contact by pressing the [▲/▼] key, and then press the [PTT] key to make the call.
3. Access "Contacts" through the menu to select "Manual Dial" to input the user ID with the numeric keypad to the popping up dialog box on the screen. It is used for private calls only.

Note:

- ◇ Encryption must be enabled on the current channel of your radio before sending encrypted transmission. Only when the target radio has the same key value and key ID with your radio, can the transmitted voice be decrypted.
- ◇ Please refer to the operation of "Encryption" on page 40.
- ◇ Please refer to the initiating call steps of "Contact" on page 23.

Initiate and receive calls in analog mode

When on the currently preset analog channel, press and hold the [PTT] key to initiate a call to all users, the TFT display screen shows  . When receive a call indicated by other users on the current analog channel or monitor is activated, the TFT display screen shows  .

 **Note:**

- ◇ If the transmitter or receiver is with "CTCSS / DCS" code, the other party radio can decode the audio successfully with same "CTCSS / DCS" code only.
 - ◇ Please refer to details of "Signaling" on page 39.
-

Advanced functions for DMR



Use the dedicated CPS software to enable/disable and preset DMR advanced functions (application) on / off and parameters set.

Remote monitor

Pre-set to prohibit the radio from being remotely monitored by others; or allow other users to remote monitor and set time for continuing to keep the MIC and transmitter on (Time range is from 10s ~ 120s).

Remote Kill

Pre-set to prohibit the radio from receiving "Remote Kill" command sent by other users; or allow the other users to receive and process the "Remote Kill" command to disable the radio. This function can be used to disable the radio when it is stolen or lost.

Radio Revive

Pre-set to restrict the radio from receiving "Radio Revive"

command sent by other users; or allow the radio to receive and process the "Radio Revive" command to activate it remotely. This function can be used to enable the radio when it is lost and found.

Radio Detection

Pre-set to prohibit or allow the radio from being remotely detected whether the radio is in communication range or active state without any prompt.

Call Alert

Pre-set to prohibit or allow the radio from receiving alert tone to ask for calling back when you are free.

GPS

Turn on/off GPS and position report feature to report the position information to the preset designated channel at the preset intervals.

Record

Pre-set to prohibit or allow the recording for any of receive, transmit, receive + transmit voice.

DTMF

Pre-set to prohibit sending DTMF tones; or allow to send a DTMF prompt tone when press the [PTT] key to transmit. It can remind the receiver that there is a call need to listen in time.

Encryption

Preset to encrypt the voice transmission of the digital channels. But the encryption is a software-based scrambling solution for preventing eavesdropping. The receiver radio must have same encryption method, level, alias and value as the transmitter radio to decrypt the encrypted voices from each other.

Notes:

- ◇ DMR Advanced functions (application) apply to digital mode only.
 - ◇ For DMR advanced functions (application), please refer to "Menu" operation on page 23.
 - ◇ Transmission of remote monitor, Remote kill, Radio Revive, Radio Detection, Call Alert, etc. Please refer to "Application" operation of the "Contacts" on page 23.
-

Menu function operation

The various functions, applications and parameter configuration of the radio can be check and set by menus, if they are allowed by the dealer or system administrator.

Contacts

The contacts provide the "address book" for the radio. Each entry corresponds to an alias or ID used to initiate a call, as well as operations and applications for DMR advanced functions (Application).

Contact list

Processes:

1. Press the preset [Contact] key to access the menu.

OR

1. Access the menu and press [▲/▼] key to select **Contacts**, and press [Select] key to enter.
2. Press the [▲/▼] key to select the **Contact list**, press [Select] key to enter and select the desired contact.
 - Press [PTT] key to initiate a call;
 - Press [Select] key to make following options:

Group Call ID:

SendMsg → press [Select] key → Edit SMS → press [OK] key to choose operation of **SendMsg** (Send Message), **InsertComMsg** (Insert Common Message), **Save, Exit Editor** by [▲/▼] key → press [Select] key to confirm → return back to the previous level;

Private Call ID:

- ① **Application(Advanced)** → press [Select] key → choose operation of **Radio Detection, Call Alert, Remote Mon (Monitor), Radio Kill, Radio Revive** by [▲/▼] key → press [Select] key to send → "success" or "Fail" character pops up on the screen → Return to the previous level;
- ② **Edit (contact)** → Press [Select] key to choose operation of **Number, Name and Save** by [▲/▼] key → press [Select] key to input number and name or Save → press [OK] key to confirm the operation → return to previous level;
- ③ **Delete** → press [Select] key → "Are you sure?" pops up on the screen → press [OK] key to confirm deletion, or press [Back] key to cancel deletion → return back to previous level;
- ④ **SendMsg** → press [Select] key to Edit SMS → press [OK] key to choose operation of **SendMsg** (Send Message), **InsertComMsg** (Insert Common Message), **Save, Exit Editor** by [▲/▼] key → press [Select] key to confirm the operation → return to the previous level.

New Contact

Processes:

1. Press the preset [Contact] key to access the contact.

OR

1. Access the menu and press [▲/▼] key to select **Contacts**, and press [Select] key to enter.

2. Press the [▲/▼] key to choose the **New Contact**, press [Select] key to enter.

3. Press the [▲/▼] key to choose the desired option.

① **Number** → press [Select] key → edit interface → input the numbers with the numeric keyboard → press [OK] key to confirm return back to the previous level;

② **Name** → press [Select] key → edit interface → input the numbers with the numeric keyboard → press [OK] key to confirm → return back to the previous level;

③ **Save** → press [Select] key to confirm → Return back to the previous level

Manual Dial

Processes:

1. Press the preset [Contact] key to access the contact.

OR

1. Access the menu and press [▲/▼] key to select **Contacts**, and press [Select] key to enter.

2. Press the [▲/▼] key to select the **Manual Dial**, press [Select] key to enter the interface for inputting the **ID**.

3. Input the **ID** with numeric keyboard.

○ Press [PTT] key to initiate a call;

○ Press [OK] key to make following options:

① **Application** → press [Select] key to choose operation of

Radio Detection, Call Alert, Remote Mon(Monitor), Radio Kill, Radio Revive by [▲/▼] key → press [Select] key to confirm the operation → "success" or "fail" character pops up on the screen Return to the previous level;

② **SendMsg** → press [Select] key to Edit SMS → press [Ok] key to choose operation of **SendMsg** (Send Message), **InsertComMsg** (Insert Common Message), **Save, Exit Editor** by [▲/▼] key → press [Select] key to confirm the operation → return to the previous level.

Ham Private Contacts

Processes:

1. Access the menu and press [▲/▼] key to select **Contacts**, and press [Select] key to enter.

2. Press the [▲/▼] key to select the **Ham Private Contacts**, press [Select] key to enter the **Ham Private Call Contacts List**. Up to 200,000 private contacts can be added.

3. Choose the desired private contact by [▲/▼] key, then the selected contact **ID** number will display at the top left of the screen and the serial No of the contact displays at the upper right.

OR

◇ Long press and hold the [MENU] key for 3 seconds, a dialogue window pops up on the interface.

◇ Input the first few digits of the private contact **ID** to search with the numeric keypad, after that press the [MENU] key to confirm, and then the screen jumps to the search results. Press [▲/▼] key to choose the desired **ID**.

4. Press the [PTT] key to initiate a private call;

OR

◇ Press the [MENU] key → press [▲/▼] key to make the

following options:

- ① **Application** → press [Select] key to choose operation of **Radio Detection, Call Alert, Remote Mon(Monitor), Radio Kill, Radio Revive** by [▲/▼] key → press [Select] key to confirm the operation → "success" or "fail" character pops up on the screen → Return to the previous level;
- ② **SendMsg** → press [Select] key to Edit SMS → press [Ok] key to choose operation of **SendMsg** (Send Message), **InsertComMsg** (Insert Common Message), Save, Exit Editor by [▲/▼] key → press [Select] key to confirm the operation → return to the previous level.
- ③ **Details** → press [Select] key → the display shows ID, nick name, name, city, province, country etc information → press [Select] key to confirm → Return to the previous level.

Notes:

- ◇ "128Bytes" mode must be selected firstly before writing Ham Private Contacts list, so that details like name, city, province, country, etc information can be checked. But this mode requires a long writing time. Make sure the radio keeps normal power supply during the writing process.
- ◇ If "16Bytes" mode is selected before writing More Private Contacts list, only contact ID and Nick name can be checked. This mode has a shorter writing time which takes about 10 minutes. Make sure the radio keeps normal power supply during the writing process.

Ham Group Contacts

Processes:

1. Access the menu and press [▲/▼] key to select **Contacts**, and press [Select] key to enter.

2. Press the [▲/▼] key to select the **Ham Group Contacts**, press [Select] key to enter the Ham Group Call Contacts List. Up to 20,000 group contacts can be added.
3. Choose the desired group contact by [▲/▼] key, then the selected contact ID number will display at the top left of the screen and the serial No of the contact displays at the upper right.

OR

- ◇ Long press and hold the [MENU] key for 3 seconds, a dialogue window pops up on the interface.
 - ◇ Input the first few digits of the group contact ID to search with the numeric keypad, after that press the [MENU] key to confirm, and then the screen jumps to the search results. Press [▲/▼] key to choose the desired ID.
4. Press the [PTT] key to initiate a group call;
 5. Press [Back] key to return to the previous level.

Ham RX Group List

If allowed in software, Ham RX Group List can be set On or Off in menu to allow/disable the radio to receive any group call from the receiving group call list when it has same working channel/frequency.

Processes:

1. Access the menu and press [▲/▼] key to select Contacts, and press [Select] key to enter.
2. Press the [▲/▼] key to select the Ham RX Group List, press [Select] key to enter the Ham RX Group Call Contacts List. Up to 20,000 group contacts can be added.
3. Press the [▲/▼] key to Ham RX Group List ON/OFF selection.
4. Press [MENU] key to turn it On or OFF.
5. Press [Back] key to return to the previous level.

Message

The radio can receive and send text messages from / to the other radios. The below ways can be used to send messages.

CreateMsg

Processes:

1. Press the preset [Message] key to access the menu.

OR

1. Access the menu and press [▲/▼] key to select **Message**, and press [Select] key to enter.

2. Press the [▲/▼] key to **CreateMsg** and press [Select] key to enter message editing interface.

3. After editing, press [OK] key to make following options:

① **SearchLinkman** → press [Select] key to enter and choose the contact by [▲/▼] key → press the [PTT] key to initiate a call or press [Select] key to send the message → the message sending status pops up on the screen;

② **WriteNumber** → input the contact number with the numeric keyboard → press the [Ok] key to send the message → the message sending status pops up on the screen;

③ **InsertComMsg** (Insert Common Message) → press [Select] key to choose the desired message by [▲/▼] key → press [Select] key → edit or press [OK] key to choose contact to send.

④ **Save** → press [Select] key to save the message → return to the previous level;

⑤ **ExitEditor** → press [Select] key to return to the previous level;

CommMsg

Processes:

1. Press the preset [Message] key to access the menu.

OR

1. Access the menu and press [▲/▼] key to select **Message**, and press [Select] key to enter.

2. Press the [▲/▼] key to select **CommMsg** and press [Select] key to enter the common message list or "Empty" Do you want Add?" character pops up on the screen.

① In common message list → press [▲/▼] key to select the desired message → press [OK] key to make following options:

◇ **Display** → Press [Select] key to display the full message → Press [Back] key to return to the previous level;

◇ **AddCommMsg** → press [Select] key → input the message with the numeric keyboard → press [OK] key → Save or ExitEditor press [Select] key → return to the previous level;

◇ **Edit** → press [Select] key → edit the message with the numeric keyboard → press [Ok] key → Save or ExitEditor → press [Select] key to save the message or exit the edition → return to the previous level;

◇ **Delete** → press [Select] key → "Are you sure?" pops up on the screen → press [OK] key to confirm deletion or press [Back] key to cancel deletion → return back to previous level;

◇ **Send** → Press [Select] key → edit SMS and press [Select] key to search a contact or write a receiver ID → press [Ok] key to send a message → return to the previous level

② **Add message** → press [Select] key to add new common message / press [Back] key to cancel → press [Ok] key → Save or ExitEditor → press [select] key to save the message or exit the edition → return to the previous level.

Inbox

Processes:

1. Access the menu and press [▲/▼] key to select **Message**, and press [Select] key to enter.

2. Press [▲/▼] key to **Inbox**, and press [Select] key to make the following options:

① **Inbox List** → press [Select] key to enter and choose the received message by [▲/▼] key → press [Select] key to display full message → press [Select] key to perform the following options and processes:

◇ **Reply** → press [Select] key → edit SMS → press [OK] key to choose operation of **SendMsg, InsertComMsg, ExitEditor** by [▲/▼] key → press [Select] key to confirm the operation;

◇ **Forward** → Press [Select] key → search or Write the contacts by Search or WriteNumber → Press [Select] key to choose contact by [▲/▼] key or input ID number * Press [OK] key to send SMS;

◇ **Edit** → press [Select] key to write the message → press [OK] key to choose operations of **SearchLinkman, WriteNumber, InsertComMsg, Save or ExitEditor** by [▲/▼] key → press [Select] key to send message or save or exit edition and return to the previous level;

◇ **Delete** → "Are you sure?" pops up on the screen → press [OK] key to confirm deletion or press [Back] key to cancel deletion → return back to previous level;

② **Delete All** → "Are you sure?" pops up on the screen → press [OK] key to confirm deletion or press [Back] key to cancel deletion → return back to previous level;

Outbox

Processes:

1. Access the menu and press [▲/▼] key to select **Message**, and press [Select] key to enter.

2. Press the [▲/▼] key to **Outbox**, and press [Select] key to make the following options:

① **Outbox List** → press [Select] key to enter and choose the message by [▲/▼] key → press [Select] key to display full message → press [OK] key to perform the following options and processes:

◇ **Search** → press [Select] key to search the contact → press the [PTT] key to initiate a call or press [Select] key to send the message → the message sending status pops up on the screen;

◇ **WriteNumber** → Press [Select] key to input the contact ID → Press [OK] key to send the message → the message sending status pops up on the screen;

◇ **InsertComMsg** (Insert Common Message) → press [Select] key to choose the desired message by [▲/▼] key → press [Select] key → edit or press [OK] key to choose the contact to send.

◇ **Save** → press [Select] key to save the message → return to the previous level;

◇ **Delete** → "Are you sure?" pops up on the screen → press [OK] key to confirm deletion or press [Back] key to cancel deletion → return back to previous level;

◇ **Exit Editor** → press [Select] key to return to the previous level;

② **Delete All** → "Are you sure?" pops up on the screen →

press [OK] key to confirm deletion or press [Back] key to cancel deletion → return back to previous level;

Draft Box

1. Access the menu and press[▲/▼] key to select **Message**, and press [Select] key to enter.

2. Press the[▲/▼] key to **Draftbox**, and press [Select] key to make the following options:

① **Draft List** → press [Select] key to enter and choose the message by[▲/▼] key → press [Select] key to display full message → press [OK] key to perform the following options and processes:

◇ **Search** → press [Select] key to search the contact → press the [PTT] key to initiate a call or press [Select] key to send the message → the message sending status pops up on the screen;

◇ **WriteNumber** → Press [Select] key to input the contact ID → Press [OK] key to send the message → the message sending status pops up on the screen;

◇ **InsertComMsg** (Insert Common Message) → press [Select] key to choose the desired message by[▲/▼] key → press [Select] key → edit or press [OK] key to choose the contact to send.

◇ **Save** → press [Select] key to save the message → return to the previous level;

◇ **Delete** → "Are you sure?" pops up on the screen → press [OK] key to confirm deletion or press [Back] key to cancel

deletion → return back to previous level;

◇ **ExitEditor** → press [Select] key to return to the previous level;

② **Delete All** → "Are you sure?" pops up on the screen → press [OK] key to confirm deletion or press [Back] key to cancel deletion → return back to previous level;

Notes:

◇ If Common Message list is empty, you should pre-program the common messages by CPS software or enter into "CommMsg " menu to add messages firstly;

◇ Hold and long press the *#* key for 3 seconds to change the Input modes in writing and editing messages and other processes. The input modes are AB / uppercase, ab / lowercase, 12 / digits, and PY / Chinese.

◇ In the process of searching contacts or inputting ID numbers to send SMS, when press the [PTT] key, the radio initiates a call.

Call Log

Information for recent dialed calls, received calls and missed calls can be checked by users thru Call Log menu. Call logs help to manage the recent call activities.

Dialed Calls

Processes:

1. Access the menu and press [▲/▼] key to select **CallLog**,

and press [Select] key to enter.

2. Press the [▲/▼] key to **DailedNumbs**, and press [Select] key to make the following options:

①. **DialedNumbs List** → press [Select] key to enter and choose the number by [▲/▼] key → press [Select] key to make the following options and processes:

◇ **View** → Press [Select] key to check the dialed number → Press [Back] key to return to the previous level;

◇ **TimeOfCall** → press [Select] key to display the call time and duration information → press [back] key to return to previous level;

◇ **SendMsg** → Press [Select] key to edit the message → Press [OK] key to choose operation of **SendMsg**,

InsertComMsg, ExitEditor by [▲/▼] key → Press [Select] key to confirm the operation → Return to the previous level;

◇ **Delete** → "Are you sure?" characters pops up on the screen → press [OK] key to confirm deletion or press [Back] key to cancel deletion → return back to previous level;

②. **Delete All** → "Are you sure?" characters pops up on the screen → press [OK] key to confirm deletion or press [Back] key to cancel deletion → return back to previous level;

Received Calls

Processes:

1. Access the menu and press [▲/▼] key to select **CallLog**, and press [Select] key to enter.

2. Press the [▲/▼] key to **ReceiveCalls**, and press [Select]

key to make the following options:

①. **ReceiveCalls List** → press [Select] key to enter and choose the number by [▲/▼] key → press [Select] key to make the following options and processes:

◇ **View** → Press [Select] key to check the received call number → Press [Back] key to return to the previous level;

◇ **TimeOfCall** → press [Select] key to display the call time and duration information → press [back] key to return to previous level;

◇ **SendMsg** → Press [Select] key to edit the message → Press [OK] key to choose operation of **SendMsg**,

InsertComMsg, ExitEditor by [▲/▼] key → Press [Select] key to confirm the operation → Return to the previous level;

◇ **Delete** → "Are you sure?" characters pops up on the screen → press [OK] key to confirm deletion or press [Back] key to cancel deletion → return back to previous level;

②. **Delete All** → "Are you sure?" characters pops up on the screen → press [OK] key to confirm deletion or press [Back] key to cancel deletion → return back to previous level;

Missed Calls

Processes:

1. Access the menu and press [▲/▼] key to select **CallLog**, and press [Select] key to enter.

2. Press the [▲/▼] key to **MissedCalls**, and press [Select] key to make the following options:

①. **MissedCalls List** → press [Select] key to enter and choose

the number by [▲/▼] key → press [Select] key to make the following options and processes:

- ◇ **View** → Press [Select] key to check the missed call number → Press [Back] key to return to the previous level;
- ◇ **TimeOfCall** → press [Select] key to display the call time and duration information → press [back] key to return to previous level;
- ◇ **SendMsg** → Press [Select] key to edit the message → Press [OK] key to choose operation of **SendMsg**, **InsertComMsg**, **ExitEditor** by [▲/▼] key → Press [Select] key to confirm the operation → Return to the previous level;
- ◇ **Delete** → "Are you sure?" characters pops up on the screen → press [OK] key to confirm deletion or press [Back] key to cancel deletion → return back to previous level;
- ②. **Delete All** → "Are you sure?" characters pops up on the screen → press [OK] key to confirm deletion or press [Back] key to cancel deletion → return back to previous level;

Scan

Scan, Scan list, Scan Mode and Roaming of the radio can be enabled or disabled by following ways.

Scan (On/Off)

Processes:

1. Press the preset [Scan On/Off] key to turn on/off the scan
2. Hold and long press [▲/▼] key to turn on scan, and press any key to turn if off.

OR

1. Access the menu and press [▲/▼] key to select Scan, and press [Select] key to enter.
2. Press the [▲/▼] key to Scan and press [Select] key to enter.
 - ①. **Select List** → press [Select] key to enter and choose the list by [▲/▼] key → press [Select] key to confirm the selection and return to the previous level.
 - ②. **Scan On/Off** → press [Select] key to turn it on or off.
 - ③. **RoamScan On/Off** → press [Select] key to turn it on or off.

Scan List

Processes:

1. Access the menu and press [▲/▼] key to select **Scan** and press [Select] key to enter.
2. Press the [▲/▼] key to **Scan list** and press [Select] key to enter.
3. Press the [▲/▼] key to the desired scan list and press [Select] key to enter the list.
4. Choose the channel by [▲/▼] key to make following options:
 - ①. **Set Prior** → press [Select] key to set the channel to be priority → "Prior is set" pops up on the screen → Return to the channel list, where the current channel displays "P" letter;
 - ◇ **Cancel Prior** → press [Select] key to cancel the priority channel → "Cancelled" pops up on the screen → Return to the channel list, where the "P" letter disappears on current channel;
 - ◇ **Channel Del** → press [Select] key to delete the channel from the scan list → Return to the channel list;

②. **Channel Add** → press [Select] key to make below options:

Zone list → press [Select] key to choose the Zone by [▲/▼] key → press [Select] key to choose the desired channel by [▲/▼] key → press [Select] key to add the selected channel and return to the scan list.

Scan Mode

Processes:

1. Press the preset [Scan Mode] key to choose the scan mode.

OR

1. Access the menu and press [▲/▼] key to select **Scan** and press [Select] key to enter.

2. Press the [▲/▼] key to **Scan Mode** and press [Select] key to enter.

①. **Carrier** → when the radio receives an air carrier signal in scanning, it will stay at the current channel for a short time until the carrier signal disappears and continue to scanning.

②. **Time** → when the radio receives an air carrier signal in scanning, it will stay at the current channel for a preset short period (time range is 5S-20S) and continue to scanning once the preset period is up.

③. **Search** → when the radio receives an air carrier signal in scanning, it will stay at the current channel and exit the scanning. Unless you restart it.

Notes:

◇ Before any scan mode is selected, please make sure the "Scan List" preset in advance, otherwise the scan feature is unable to activate.

◇ When the scan is ON, the radio will start to scan all the receivable channels in the list.

Roaming

Roaming and Roam Mode can be enabled or disabled by following two ways:

Processes:

1. Press the preset [Roaming On/Off] key to turn on/off the roaming.

OR

1. Access the menu and press [▲/▼] key to select **Scan**, and press [Select] key to enter.

2. Press the [▲/▼] key to **Scan** and press [Select] key to enter.

①. **Select List** → press [Select] key → press [▲/▼] key to choose the list → press [Select] key to confirm the selection and return to the previous level.

②. **Scan On/Off** → press [Select] key to turn it on or off.

③. **RoamScan On/Off** → press [Select] key to turn it on or off.

Roam Setting

Processes:

1. Access the menu and press [▲/▼] key to select Scan and press [Select] key to enter.

2. Press the [▲/▼] key to **RoamSetting** and press [Select] key to make following options:

①. **Roam Mode** → press [Select] key to choose the modes of **Auto, Manual and RSSI** by [▲/▼] key → press [Select] key to confirm the selection and return to the previous level.

Annexed table 1: Roam Mode description

Roaming Mode	Description
Auto	Once searching an available repeater from the scan list, the radio will lock to the current available repeater and pause auto roaming. Then, it will connect with the available repeater according to the preset Connect Check Timer. If the connection fails after the preset Connect Time is used up, it will restart the strong signal Auto roaming search.
Manual	Users can manually roam to the next available repeater. Once it is on, all repeater channels in the scan list will be waken up to search the nearest available repeaters until finds an available one. Every time the nearest available repeater is found, a Connect Re-check Timer (Repeater Check Timer) will be enabled. Users can also lock the repeater by short pressing the [OK/Select] key. The next available repeater is not necessarily the one with the largest RSSI value in the channels of the scan list.

Roaming Mode	Description
RSSI (Strong Signal Roaming)	Once a repeater in the channels of the scan list with RSSI more than preset RSSI threshold value is searched by RSSI mode, the radio will lock to the current channel and pause the strong signal auto roaming. Then it will connect with the current repeater according to the preset Connect Check Timer. If the connection fails after the preset Connect Time is used up, it will restart the strong signal Auto roaming search.

②. **RSSI Set** → press [Select] key to display the current RSSI threshold value → press [▲/▼] key to adjust the desired value → press [OK] key to confirm the modification → "Set Ok!" pops up on the screen and return to the previous level.

Annexed table 2: RSSI threshold value set

Range (Unit: dBm)	
Maximum	-90dBm
Minimum	-125dBm
Increment	-1dBm

 **Notes:**

◇ The received signal strength (RSSI threshold value) is settable. If the RSSI mode is enabled and the searched repeater RSSI value is more than the preset threshold, the repeater's

transmitting signal coverage will be automatically recognized as good, and then the radio will suspend RSSI roaming.

◇ The stopped repeater is not necessarily the one with the largest RSSI value in the channels of the scan list.

③. **Connect Check Timer** → press [Select] key to display the current time value(second) → press [▲/▼] key to adjust the desired connect check time → press [OK] key to confirm the modification → "Set Ok!" pops up on the screen and return to the previous level.

Annexed table 3: Connect Check Time set

Range (Unit: second)	
Maximum	255
Minimum	0
Increment	1

 **Notes:**

◇ When the nearest available repeater is searched by Manual Roaming, the radio will immediately start timing according to the preset dwell time value. If the available repeater is not confirmed by pressing the [OK] key within the preset time, once the timer reaches the preset time, the radio will stop roaming; or restart roaming to find the next available repeater.

④. **Connect ReCheck Timer** → press [Select] key to display the current time value(second) → press [▲/▼] key to adjust the desired recheck time → press [OK] key to confirm the modification → "Set Ok!" pops up on the screen and return to the previous level.

Annexed table 4: Connect ReCheck Timer set

Range (Unit: second)	
Maximum	255
Minimum	0
Increment	1

 **Notes:**

◇ When the available repeaters are searched by Auto roaming or RSSI roaming, the radio is confirmed to lock at the currently available repeater and the roaming is paused. Then, the radio will transmit signals at regular intervals based on the preset Connect ReCheck Timer to connect with the current repeater. If fails to connect with the currently available repeater in preset Connect Timer of transmission (set on the Connect Timer table), the radio will restart Auto Roaming or RSSI Roaming to search any nearest available repeater.

⑤. **Connect Times** → press [Select] key to display the current connect time → press [▲/▼] key to adjust the desired connect times → press [OK] key to confirm the modification → "Set Ok!" pops up on the screen and return to the previous level.

Annexed table 5: Connect Times Set

Range (Unit: time)	
Maximum	10
Minimum	1
Increment	1

 **Notes:**

◇ No matter which roaming mode is selected, in searching, each repeater channel in the scan list will try to connect with nearby available repeaters based on the preset Connect Times. If the pause channel fails to find the available repeaters within the preset Connect Times, it will continue to scan the next repeater channel from the list till find an available one.

Precautions for roaming

1. Before any scan mode is selected, please make sure the "Scan List" preset in advance, otherwise the scan feature is unable to activate.
2. When the roaming is activated, the radio will scan all repeater channels (TX/RX inter-frequency) only; will not scan channels with same TX/RX frequency.
3. When the roaming is activated, if there is no TX/RX inter-frequency channel (repeater channels) in the scan list, after scanning the current selected scan list, it will exit the roaming function.
4. In roaming searching, if PTT button is pressed, the radio

will stop roaming and return back to preset Scan reply/transmit Mode to initiate a call. It will continue to roam after PTT is released.

5. When roaming is on, the radio is default to scan in the main band (Band A). When the main band (Band A) is in roaming, channel selection is prohibited. However, menu accessing and setting of main band (Band A) still can be made by selecting the "CTRL" icon, or initiate a call by selecting the "PTT" icon display.

6. When the main band (Band A) is in roaming, channel and VFO operation and menu accessing & setting of Band B still can be made by selecting the "CTRL" icon display. And band B can remain in standby or normal receiving mode, and can initiate a call by selecting the "PTT" icon display.

 **Zones & Channel**

The following two ways can be used to select and switch in Zones and channels.

Processes:

1. Press the preset [Zone & Channel] key to switch in zones and channels.

OR

1. Access the menu and press [▲/▼] key to select **Zone & Channel** and then press [Select] key to enter.

2. Press [▲/▼] key to desired zone and press [Select] key to enter.

3. Press [▲/▼] key to desired channel and press [Select] key

to make following options:

- ①. **Select** → press [Select] key → change the zone and channel → return to the standby interface;
- ②. **Modify Name** → press [Select] key → modify the channel name → press the [OK] key to confirm and return to the previous level.

Local Set

If the basic operation and functions of the menu are allowed by software to set and check, below functions are operational thru accessing **Local Set** menu.

Language

Processes:

1. Access the menu and press [▲/▼] key to choose **Local Set**, and then press [Select] key to enter.
2. Press [▲/▼] key to choose the **Language** and press [Select] key to enter.
3. Press [▲/▼] key to choose the desired Language and press [Select] key to change.
4. "Lang is set" pops up on the screen and return back to the previous level.

KeypadLock

Processes:

1. Access the menu and press [▲/▼] key to choose Local Set, and then press [Select] key to enter.

2. Press [▲/▼] key to choose **KeypadLock** and press [Select] key to enter.
3. Choose operation of **AutoLock SW and ManualLock SW** by [▲/▼] key and press [Select] key to switch it on / off.
4. Press [Back] key to return to the previous level.

BackLight

Processes:

1. Press the preset [BackLight on / off] key.

OR

1. Access the menu, press [▲/▼] key to choose **Local Set**, and then press [Select] key to enter.
2. Press [▲/▼] key to choose **BackLight** and press [Select] key to make the following options and procedures:
 - ①. **BL switch** → press [Select] key → choose operation of **BL on, BL off, Auto** by [▲/▼] key → press [Select] key to confirm → return to the previous level.
 - ②. **Brightness** → press [Select] key → press [▲/▼] to select desired brightness → press [OK] key to confirm → return to the previous level;
 - ③. **DelayTime** → press [Select] key → press [▲/▼] to select → press [OK] key to confirm → return to the previous level;

LED indicator

Processes:

1. Access the menu, press [▲/▼] key to choose **Local Set**, and then press [Select] key to enter.

2. Press [▲/▼] key to choose **LEDs** and press [Select] key to enter.
3. Press [Select] key to switch it on / off.
- 4 Press [Back] key to return to the previous level.

Notes:

- ◇ If the LED indicator is OFF, it will not light in receiving and transmitting;
 - ◇ If the LED indicator is ON, it will light in receiving and transmitting.
-

Display Mode

Processes:

1. Access the menu, press [▲/▼] key to choose **Local Set**, and then press [Select] key to enter.
2. Press [▲/▼] key to choose **DisplayMode** and press [Select] key to enter.
3. Press [▲/▼] key to choose operation of **CHN+Name**, **CHN+FREQ**, **CHN**, and press [Select] key to confirm.
4. "DispMode is Set" pops up on the screen and return to the previous level.

VOX

Processes:

1. Press the preset [VOX] key to turn it on / off.
- OR**
1. Access the menu, press [▲/▼] key to choose **Local Set**,

and then press [Select] key to enter.

2. Press [▲/▼] key to choose **VOX** and press [Select] key to make the following options and processes:

- ①. **Vox Switch** → press [Select] key to turn it On or Off;
 - ②. **Vox Level** → press [Select] key → press [▲/▼] key to choose desired level → press [Select] key to confirm → return to the previous level;
 - ③. **Vox delay** → press [Select] key → choose operation of **OFF**, **Tran_Rx**, **Tran_Tx**, **Tran_RxTx** by [▲/▼] key → press [Select] key to confirm → return to the previous level;
-

Notes:

- ◇ If VOX is on, when the audio amplitude is detected to reach the preset level, the radio will automatically initiate a call without pressing the [PTT] key
 - ◇ The higher sensitivity level, the smaller audio amplitude is required. The smaller sensitivity level, the greater audio amplitude is required.
-

Channel Switch (Channel Sw)

Processes:

1. Access the menu, press [▲/▼] key to choose **Local Set**, and then press [Select] key to enter.
2. Press [▲/▼] key to choose **Channel Sw** and press [Select] key to enter.
3. Press [Select] key to turn it on / off.
4. Press [Back] key to return to the previous level.

Notes:

◇ If the channel switch is OFF, the radio can't rotate the channel selector to choose the frequency or channel.

Factory Reset

Processes:

1. Access the menu, press [▲/▼] key to choose **Local Set**, and then press [Select] key to enter.
 2. Press [▲/▼] key to choose **Factory Reset** and the display shows "Are you sure restore factory settings" by pressing [Select] key.
 3. Press [OK] key to confirm factory reset, or press [Back] key to cancel.
-

Notes:

◇ If confirm to restore the factory set, the radio will be restored to the factory initial state. All data like frequencies, channels and etc set by CPS will be completely cleared and can't be recovered.

AB Repeat

The local A/B band Repeat Mode can be set by CPS or menu.

Processes:

1. Press the preset [AB Repeat] key.

OR

1. Access the menu, press [▲/▼] key to choose **Local Set**, and then press [Select] key to enter.

2. Press [▲/▼] key to choose **AB Repeat**, press [Select] key to make the following options and processes:

- ①. **A/B RepeatSw** → press [Select] key to turn A/B band Repeat On or Off.
 - ②. **A/B MonitorSw** → press [Select] key to turn monitor on / off;
 - ③. **A RepeatMode** → press [Select] key → choose operation of **OFF, Tran_Rx, Tran_Tx, Tran_RXTX** by [▲/▼] key → press [Select] key to confirm → "Set ok" pops up on the screen → return to the previous level;
 - ④. **B-RepeatMode** → press [Select] key → choose operation of **OFF, Tran_Rx, Tran_Tx, Tran_RXTX** by [▲/▼] key → press [Select] key to confirm → "Set ok" pops up on the screen → return to the previous level;
-

Notes:

- ◇ If AB Repeat is on, the radio will work based on the preset mode;
 - ◇ If AB Monitoring is on, the radio can hear the audio of other users during the repeater process;
 - ◇ Please refer to "AB Repeat Application" on page 48.
-

Parameters

If it is allowed by software, set and check TOT, High / Low Power, Time Slot / Repeat setting, Power Saving mode, Encryption Level and etc. can be made thru **Parameters** menu.

TOT

Processes:

1. Access the menu, press [▲/▼] key to choose **Parameters**, and then press [Select] key to enter.
 2. Press [▲/▼] key to choose TOT and press [Select] key to enter.
 3. Press [▲/▼] key to choose the Call Time(S) and press the [OK] key to confirm.
 4. "Calltime is set" pops up on the screen and the radio returns to the previous level.
-

Notes:

- ◇ Range of Call Time: Off, 20S, 30S, 40S, 50S * 500S;
 - ◇ The Call Time is for limiting the time of each call, which can be used to avoid affecting the normal communication of other users due to the long-term transmission of the radio.
-

Power

Processes:

1. Press the preset [Power] key to switch the power between high and low.

OR

1. Access the menu, press [▲/▼] key to choose **Parameters**, and then press [Select] key to enter.
2. Press [▲/▼] key to choose **Power** and press [Select] key to choose High or Low Power and press [Select] to confirm.
3. "Power is set" pops up on the screen and the radio returns to the previous level.

Slot / Repeat Setting

Processes:

1. Access the menu, press [▲/▼] key to choose **Parameters**, and then press [Select] key to enter.
 2. Press [▲/▼] key to choose **Slot/Repeat Setting**, and then press [Select] key make following options and processes:
 - ①. **RX DirectSlot** → press [Select] key → choose operation of **OFF, Slot 1, Slot 2** by [▲/▼] key → press [Select] key to confirm → "Set OK!" pops up on the screen → return to the previous level;
 - ②. **TX DirectSlot** → press [Select] key → choose operation of **OFF, Slot 1, Slot 2** by [▲/▼] key → press [Select] key to confirm → "Set OK!" pops up on the screen → return to the previous level;
-

Notes:

- ◇ Slot / Repeat setting is set according to the channel type that currently accesses the menu (Repeat with different TX/RX frequency or RX/TX with same frequency).
-

Sleep Mode

Processes:

1. Access the menu, press [▲/▼] key to choose **Parameters**, and then press [Select] key to enter.
2. Press [▲/▼] key to choose **SleepMode** and press [Select] key to make the following options and procedures:
 - ①. **SlpMode SW** → press [Select] key to turn Sleep mode on/off;

②. **Delay Time** → press [Select] key → press [▲/▼] to select the time → press [OK] key to confirm → "Set Ok!" pops up on the screen → return to the previous level;

③. **Duty cycle** → press [Select] key → choose operation of **1: 1, 1: 2, 1: 4** by [▲/▼] key → press [Select] key to confirm → "Set Ok!" pops up on the screen → return to the previous level;

Notes:

◇ If it is allowed by the CPS software, set a reasonable sleep ratio according to the actual use requirements. The larger ratio, the more power is saved, but it may cause slower access.

Squelch Level (SQ level)

Processes:

1. Access the menu, press [▲/▼] key to choose **Parameters**, and then press [Select] key to enter.
2. Press [▲/▼] key to choose **SQ Level** and press [Select] key to enter.
3. Press [▲/▼] key to select the desired level or normally open(Level 0), and press [Select] key to confirm.
4. "Sq level is set" pops up on the screen and the radio returns to the previous level.

Wide/ Narrow Band

Processes:

1. Access the menu, press [▲/▼] key to choose **Parameters Setting**, and then press [Select] key to enter.

2. Press [▲/▼] key to choose **Band** and press [Select] key to enter.

3. Press [▲/▼] key to select the desired narrow /wide band and press [Select] key to confirm.

4. "Set Ok" pops up on the screen and the radio returns to the previous level.

Busy Channel Lockout (BCLO)

Processes:

1. Access the menu, press [▲/▼] key to choose **Parameters Setting**, and then press [Select] key to enter.
2. Press [▲/▼] key to choose **BCLO** and press [Select] key to turn Busy On or OFF
3. Press [Back] key to return to the previous level.

Signaling

Processes:

1. Access the menu, press [▲/▼] key to choose **Parameters**, and then press [Select] key to enter.
2. Press [▲/▼] key to choose **Signaling** and press [Select] key to enter.
3. Press [▲/▼] key to select the desired item and press [Select] key to make the following options and procedures:
 - ①. **RX Subaudio** → press [Select] key to make the following options and processes:
 - ◇ **Signaling off** → press [Select] key to turn off the CTCSS/DCS code → "Set Ok" pops up on the screen and returns to the previous level;

◇ **CTCSS** → press [Select] key → choose the CTCSS code by [▲/▼] key → press [Select] key to confirm → "Set Ok" pops up on the screen and returns to the previous level;

◇ **DCS** → press [Select] key → choose the DCS code by [▲/▼] key → press [Select] key to confirm → "Set Ok" pops up on the screen and returns to the previous level;

◇ **DCS Reverse** → press [Select] key → choose the DCS Reverse code by [▲/▼] key → press [Select] key to confirm → "Set Ok" pops up on the screen and returns to the previous level;

②. **TX Subaudio** → Press [Select] key to make the following options and procedures:

◇ **Signaling off** → press [Select] key to turn off the CTCSS/DCS code → "Set is ok" pops up on the screen and returns to the previous level;

◇ **CTCSS** → press [Select] key → choose the CTCSS code by [▲/▼] key → press [Select] key to confirm → "Set Ok" pops up on the screen and returns to the previous level;

◇ **DCS** → press [Select] key → choose the DCS code by [▲/▼] key → press [Select] key to confirm → "Set Ok" pops up on the screen and returns to the previous level;

◇ **DCS Reverse** → press [Select] key → choose the DCS Reverse code by [▲/▼] key → press [Select] key to confirm → "Set Ok" pops up on the screen and returns to the previous level;

ENC Level (Encryption)

Processes:

1. Access the menu, press [▲/▼] key to choose **Parameters**, and then press [Select] key to enter.
 2. Press [▲/▼] key to choose **EncLevel** and press [Select] key to enter.
 3. Press [▲/▼] key to choose the desired encryption level or turn it off and press [Select] key to confirm.
 4. "Set Ok!" pops up on the screen and returns to the previous level;
-

Notes:

- ◇ If it is allowed by CPS software, enable this function will help to prevent other users from eavesdropping without authorization.
 - ◇ Although encryption is not a necessary requirement for receiving and transmitting. But the receiver radio must have same encryption method, level, alias and value as the transmitter radio to decrypt the encrypted voices from each other.
-

CTCSS Phase Reverse (CTCSSTail)

Processes:

1. Access the menu, press [▲/▼] key to choose **Parameters**, and then press [Select] key to enter.
2. Press [▲/▼] key to choose **CTCSSTail** and press [Select] key to enter.
3. Choose operation of **55HZ, 120, 180, 240** by [▲/▼] key and press [Select] key to confirm.
4. "Set Ok" pops up on the screen and returns to the previous level;

Tone Set

If it is allowed by CPS software, set and check the prompt tones by accessing the Tone Set menu.

Profiles

Processes:

1. Access the menu, press [▲/▼] key to choose **Tone Set**, and then press [Select] key to enter.
2. Press [▲/▼] key to choose **Profiles** and press [Select] key to enter.
3. Press [▲/▼] key to choose **General** or **Silent**, and press [Select] key to confirm the selection.
4. "Profile is set" pops up on the screen and returns to the previous level.

Key Tone

Processes:

1. Access the menu, press [▲/▼] key to choose **Tone Set**, and then press [Select] key to enter.
2. Press [▲/▼] key to choose **KeyTone** and press [Select] key to make following options and procedures:
 - ①. **KeyRingSW** → press [Select] key to turn it on / off;
 - ②. **KeyRingStat** → press [Select] key → press [▲/▼] key to choose the keytone level → press [Ok] key to confirm → "Keytone is set" pops up on the screen and returns to the previous level.

Power tone

Processes:

1. Access the menu, press [▲/▼] key to choose **Tone Set**, and then press [Select] key to enter.
2. Press [▲/▼] key to choose **Power tone** and press [Select] key to make following options and procedures:
 - ①. **CouloToneSW** → press [Select] key to turn the power tone on / off;
 - ②. **CouloToneStat** → press [Select] key → press [▲/▼] key to select desired volume → press [Ok] key to confirm → "Tone is set" pops up on the screen and returns to the previous level.

Message Tone (Msg Tone)

Processes:

1. Access the menu, press [▲/▼] key to choose **Tone Set**, and then press [Select] key to enter.
2. Press [▲/▼] key to choose **Msg tone** and press [Select] key to enter.
3. Press [▲/▼] key to choose the desired ringtone type or turn it off and press [Select] key to confirm.
4. "RingTone is set" pops up on the screen and returns to the previous level.

Private Call Tone (PCallTone)

Processes:

1. Access the menu, press [▲/▼] key to choose **Tone Set**, and then press [Select] key to enter.

2. Press [▲/▼] key to choose **PCallTone** and press [Select] key to make following options and procedures:

- ①. **PCallSW** → press [Select] key → choose operation of **Rx Begin Tone, Rx End Tone, Tx Begin Tone, Tx End Tone** by [▲/▼] key → press [Select] key to tick or cancel it → press [Back] key to return to the previous level;
- ②. **PCallTone** → press [Select] key → choose the desired ringtone type or turn it Off by [▲/▼] key → press [Select] key to confirm → "Tone is set" pops up on the screen and returns to the previous level.

Group Call Tone(GCallTone)

Processes:

1. Access the menu, press [▲/▼] key to choose **Tone Set**, and then press [Select] key to enter.
2. Press [▲/▼] key to choose GCallTone and press [Select] key to make following options and procedures:
 - ①. **GCallSW** → Press [Select] key → choose operation of **Rx Begin Tone, Rx End Tone, Tx Begin Tone, Tx End Tone** by [▲/▼] key → press [Select] key to tick or cancel it → press [Back] key to return to the previous level;
 - ②. **GCallTone** → press [Select] key → choose the desired ringtone type or turn it Off by [▲/▼] key → press [Select] key to confirm → "Tone is set" pops up on the screen and returns to the previous level.

Alert Tone

Processes:

1. Access the menu, press [▲/▼] key to choose **Tone Set**, and then press [Select] key to enter.
2. Press [▲/▼] key to choose **Call Alert tone** and press [Select] key to enter.
3. Press [▲/▼] key to select the desired ringtone type or turn it off and press [Select] key to confirm.
4. "Tone is set" pops up on the screen and returns to the previous level.

Power On Tone

Processes:

1. Access the menu, press [▲/▼] key to choose **Tone Set**, and then press [Select] key to enter.
2. Press [▲/▼] key to choose **Poweron tone SW** and press [Select] key turn it on or off.
3. Press [Back] key to return to the previous level.

Appendix

If it is allowed by CPS software, set and check GPS, FM radio, time, DTMF, HeadSet+Speaker etc. by accessing the **Appendix** menu.

GPS

Processes:

1. Access the menu, press [▲/▼] key to choose **Appendix** , and then press [Select] key to enter.

2. Press [▲/▼] key to choose **GPS** and press [Select] key to make following options and procedures:

①. **GPS switch** → press [Select] key to turn GPS On or Off;

②. **Upload SW** → press [Select] key → choose operation of **GPGGA, GPGSA, GPGSV, GPRMC** by [▲/▼] key → press [Select] key to tick or cancel → press [Back] key to return to the previous level;

③. **Group Info** → press [Select] key to enter the following options and procedures:

◇ **GPS map** → press [Select] key to display the rough distance between the radio and other members → press [▲/▼] to choose the calculation unit → press [Back] key to return to the previous level;

◇ **GPS RXMsgs** → press [Select] key to display the received message list from others → press [▲/▼] key to check the location information of others → press [Back] key to exit → press [Back] key to return to the previous level;

◇ **GPS location** → press [Select] key to display the location information of the radio → press [▲/▼] key to check GPS / GL received satellites information and signal strength (white: empty signal, red: weak signal, light blue: available signal) → Press [Select] key to return to the previous level;

◇ **Clear RXMsg** → press [Select] key to delete the received messages and return to the previous level;

④. **GPS Report Chn** → press [Select] key to check **Zone, Chn, Send interval on / off** information → press [Back] key to return to the previous level;

⑤. **Calibrator** → press [Select] key to make following options and processes:

◇ **Auto** → press [Select] key to confirm;

◇ **Manual** → Press [Select] key → Display Time zone and difference list → press [▲/▼] key to choose the desired time zone → Press [Select] key to confirm → return to the previous level;

 **Note:**

◇ GPS is allowed by software;

◇ Some GPS functions must be pre-set by software before use;

◇ Some GPS functions must be positioned successfully before use normally;

◇ Some GPS functions require other users to have GPS function and successfully positioned also before use normally;

◇ The GPS Distance Calculation or the use of some functions is for reference only, which may cause errors due to some unexpected or environmental reasons;

◇ GPS function is optional.

 **FM Radio**

Processes:

1. Access the menu, press [▲/▼] key to choose **Appendix**, and then press [Select] key to enter.

2. Press [▲/▼] key to choose **FM radio** and press [Select] key to display the FM radio frequency information.

3. Press [▲/▼] key to manually select the FM radio frequency

or seek the FM radio frequency automatically.

4. Press the [Back] key to exit the FM radio mode and return to the previous level. Or press [OK] key to make the following options and procedures:

- ①. **Save** → press [Select] key to save the current FM radio channel;
- ②. **FM List** → press [Select] key to display the list of saved FM radio frequencies → choose the desired frequency by [▲/▼] → press [Select] key to Delete or Play the frequency
- ③. **TuneMode** → press [Select] key → choose operation of **Manual, Auto** by [▲/▼] key → press [Select] key to confirm and return to the previous level.

Time

Processes:

1. Access the menu, press [▲/▼] key to choose **Appendix**, and then press [Select] key to enter.
2. Press [▲/▼] key to choose **Time** and press [Select] key to make following options and procedures:
 - ①. **Date** → Press [Select] key to display the date and year → press [▲/▼] key or input the desired date and year via numeric keyboard → press [Ok] key to confirm → "Date is set" pops up on the screen and returns to the previous level;
 - ②. **Time** → Press [Select] key to display the time → press [▲/▼] key or input the desired time via numeric keyboard → press [Ok] key to confirm → "Time is set" pops up on the screen and returns to the previous level;

- ③. **DateForm** → press [Select] key → choose the desired date form by [▲/▼] key → press [Select] key to confirm → "Date is set" pops up on the screen and returns to the previous level; → Use GPS Datetime → press [Select] key to turn it on or off;

Note:

- ◇ **Use GPS Datetime** is effective only when GPS function is on and successfully positioned.
-

DTMF

Processes:

1. Access the menu, press [▲/▼] key to choose **Appendix**, and then press [Select] key to enter.
2. Press [▲/▼] key to choose **DTMF** and press [Select] key to make following options and procedures:
 - ①. **DTMF Switch** → press [Select] key to turn it on or off;
 - ②. **DTMF LocVolume** → press [Select] key to display current local volume → press [▲/▼] key to adjust the volume → press [OK] key to confirm → "Save Ok" pops up screen and returns to the previous level;

Note:

- ◇ DTMF code Tone is only used as a alert tone to the local radio and remind the recipient user to receive the call;
 - ◇ DTMF code must be preset by CPS software.
-

Headset+Spk

Processes:

1. Access the menu, press [▲/▼] key to choose **Appendix**, and then press [Select] key to enter.
2. Press [▲/▼] key to choose **Headset+Spk** and press [Select] key to enter.
3. Choose operation of **Spk+Headset, LoudSpeaker, Headset** by [▲/▼] key and press [Select] key to confirm.
4. "Set Ok" pops up on the screen and returns to the previous level

Note:

◇ Headset+Spk is the choice of audio output mode of this radio. If "**Headset**" mode is selected, there is no audio output from the radio external speaker, but has audio output from the inserted headset. If "**LoudSpeaker**" mode is selected, there is audio output from the radio external speaker, but no audio output from the inserted headset. If "**Spk+Headset**" mode (factory default) is selected, there is audio for radio external speaker and the plugged in headset accessory.

Record

If it is allowed by CPS software, set and check record set, recording list, clear record, space info about recording by accessing Record menu.

Processes:

1. Press the preset [Record On/Off] key to turn it on / off.

OR

1. Access the menu, press [▲/▼] key to choose **Record**, and then press [Select] key to enter.
2. Press [▲/▼] key to make following options and processes:
 - ①. **Record Set** → press [Select] key → **RX record SW, TX record SW** → Press [▲/▼] key to select desired operation → press [Select] key to turn it on or off → press [Back] key to return to the previous level;
 - ②. **Record List** → press [Select] key to display the recording list → Press [▲/▼] key to choose the desired record and press [Select] key to make following options and processes:
 - ◇ **Play** → press [Select] to play the selected recording *return to the previous level after finishing playing;
 - ◇ **Delete** → press [Select] key → "Are you sure?" pops up on the screen → press [Ok] key to confirm deletion or press [Back] key to cancel deletion and return to the previous level;
 - ◇ **Information** → press [Select] key to display the detailed information of the recording.
 - ③. **Clear record** → press [Select] key → "Are you sure?" pops up on the screen → press [Ok] key to confirm deletion or press [Back] key to cancel deletion and return to the previous level;
 - ④. **Space Info** → press [Select] key to display the recorded time and total recordable time information → press [Back] key to return to the previous level

Notes

◇ The total recording time supported is more than 50 hours. It is supported to purchase additional recording time according to the actual requirement.

Device Info

If it is allowed by CPS software, set and check Radio ID, Rx Group List, CH Contact (channel contact), Version and other information by accessing **Device Info** menu.

Processes:

1. Access the menu, press [**▲/▼**] key to choose **Record**, and then press [Select] key to enter.
2. Press [**▲/▼**] key to make following options and processes:
 - ①. **Radio ID** → press [Select] key to display the Radio ID → press [Back] key or any number key to modify the desired number → press [OK] key to save → "Set ok" pops up on the screen and returns to the previous level.
 - ②. **RXGroupList** → press [Select] key to display the receiving group list → press [**▲/▼**] key to check details → press [back] key to return to the previous level;
 - ③. **CH contact** → press [Select] key to display the default channel contact information → press [Back] key to return to the previous level;
 - ④. **Version** → press [Select] key to display the local version information → press [Back] key to return to the previous level;

User_defined Mode

If it is allowed by CPS software, it is supported to check and modify the parameters of Channel or VFO mode by accessing User_defined Mode menu.

Processes:

1. In standby mode, press and hold the [A / B] key for 3 seconds to enter the User-defined mode.

OR

1. Access the menu, press [**▲/▼**] key to choose **Record**, and then press [Select] key to enter.
2. Press [**▲/▼**] key to select the following options (refer to **User_defined table**).
3. Press [Select] key to light up the cursor and enter to the editing mode.
4. Press [**▲/▼**] key to choose the desired value and press [Select] to confirm and save.
5. Press [Back] key to return to the previous level.

User-defined table

In order	Operation	Options	Confirm	Remarks
Channel Attribution (Working Mode)	Press [Select] key	Digital/Analog/RX:D/A-TX:A/TX:D/A-RX:D	Press [Select] key	For both Analog and Digital mode
Steps		5/6.25/10/12.5/25/50/100kHz		
RX Frequency		In the available range of the radio		
TX Frequency		In the available range of the radio		
Power		High/Low		For Digital Mode
RX BS (Slot)		Off / Slot 1/Slot 2		
TX BS (Slot)		Off / Slot 1/Slot 2		
RX Color Code		0~15		
TX Color Code		0~15		Not available for digital VFO mode
Alarm		On/Off		
Call Alert		On/Off		For Digital Mode
Private Call Type		PATCS /OACSU		
Meg Type		PATCS /OACSU		
Permission (TX Policy)		Impolite/ Polite to CC/ Polite to All		
RX Group List		Off / Self-defined		Not available for digital VFO mode
Encryption		Off / Defined by software		
Default Contacts		Off / Contact List		
Emergency		Off / self-defined		
Scan List		Off / self-defined		For Digital Mode
Save2SelChn (Save to current channel)				
Save2SelChn (Save to selected channel)		All available channels		For Digital VFO Mode
Save VFO				For Analog Mode only
Bandwidth		Narrow/Wide		
TX Subtone Type		Signaling Off/CTCSS/DCS/ DCS Reverse		
TX Subtone(TX Sub Item)		The signal codes of DCS/CTCSS		
RX Subtone Type		Signaling Off/CTCSS/DCS/ DCS Reverse		
RX Subtone (TX Sub Item)		The signal codes of DCS/CTCSS		
Scan List				Not available for analog VFO mode

User-defined table

In order	Operation	Options	Confirm	Remarks
Save VFO				For Analog Mode only
Save to specified channel		All available channels		

Notes

- ◇ When accessing any sub menu, press the [Back] key to return to the previous level.
 - ◇ No matter in any sub menu or menu operation, press [] key to forcibly exit the operation and return to home screen for standby mode.
-

Function Applications

Modes of TX and RX in scanning

Set TX and RX call modes in scan list by CPS software.

Scan TX Mode

In scanning, when there is detected active channel or talk group, the radio will stay at the channel for a period of time, which is called "idle time".

① The scan TX modes of the scan list can be set as below:

● Talkback

①. If it is "On", when a carrier signal of any channel in the scan list is received in scanning, press the [PTT] key to transmit to the channel within 3S after the received signal disappears.

②. If it is "OFF", the reply is based on the "Scan TX Mode" preset by the programming software.

Notes:

Scan TX Mode:

◇ **Current Channel** — reply on the channel that starts the scanning.

◇ **Last Operated Channel** — reply on the channel where the radio stays at last time.

◇ **Appointed Channel** — specify the only channel to reply.

Appointed Channel:

After selecting the channel for replying, if there is carrier signal of any channel in the scan list received in scanning, after the received signal disappears, press the [PTT] key, it will reply on the preset appointed channel.

A/B Repeat

Preset by CPS software or access the "A/B Repeat" menu to set the A/B band repeat function and application.

1. A/B Band Repeat Modes:

①. In digital mode, the same frequency band (VHF + VHF / UHF + UHF) to same frequency or cross band (VHF / UHF) can be transferred.

②. In analog mode, cross bands (VHF / UHF) can be transferred.

③. In cross band (VHF / UHF), "digital to analog" or "analog to digital" can be transferred.

2. A/B Monitor:

Press the preset [AB Monitor] key or access "AB repeat" menu to turn on/off the A/B band monitor function.

3.A/B Repeat Interruption:

①. If the A/B Repeat function is ON, this radio will be used to extend the communication coverage of other radios.

②. When your radio is working in repeat mode, you can press the [PTT] key and speak clearly into the microphone (MIC) to interrupt and make a three-party call.

Digital to Digital Mode with same frequency:

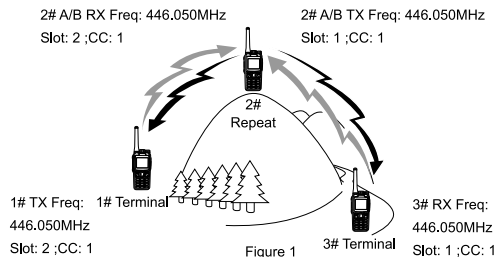

Cross Band Digital to Analog / Analog to Digital Mode:

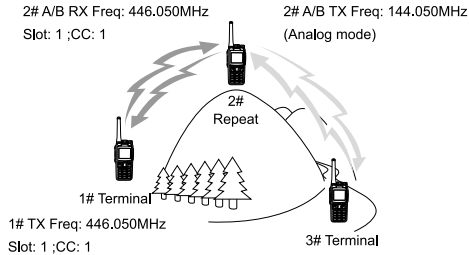

Figure 2

Cross Band Analog to Analog Mode:

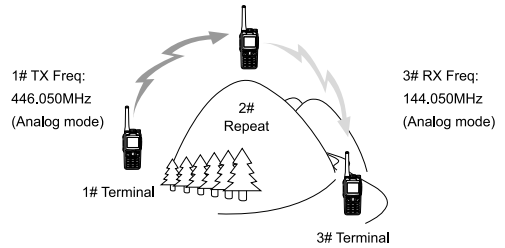

Figure 4

Digital to Analog / Analog to Digital at same frequency & Extending the Communication Coverage:

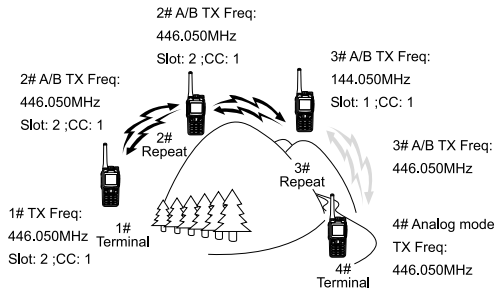

Figure 3

Repeat Modes Samples

Repeat Mode	Radio No.	End user	2# GD-88/as a Repeater	Band (Repeat)	Remarks
Digital to Digital with same frequency	1#	TX Freq: 446.050MHZ Slot: 2; CC: 1	RX Freq: 446.050MHZ Slot: 2; CC: 1	A/B	1.Time slots for RX/TX are settable based on needed; But can't set same slot for RX/TX in Repeat Mode with same frequency. 2. CC for RX/TX are settable based on needed, and can set same CC for RX/TX.
	3#	RX Freq: 446.050MHZ Slot: 1; CC: 1	TX Freq: 446.050MHZ Slot: 1; CC: 1	A/B	
Cross Band Digital to Analog Mode	1#	TX Freq: 446.050MHZ Slot: 2; CC: 1	RX Freq: 446.050MHZ Slot: 2; CC: 1	A/B	
		RX Freq: 446.050MHZ Slot: 1; CC: 1	TX Freq: 446.050MHZ Slot: 1; CC: 1		
	3#	Analog TX/RX Freq: 144.050MHZ	TX Freq: 144.050MHZ (Analog Mode)	A/B	
Cross Band Analog to Analog	1#	Analog TX/RX Freq: 446.050MHZ	RX/TX Freq: 446.050MHZ	A/B	Analog Mode can set with CTCSS/ DCS code
	3#	Analog TX/RX Freq: 144.050MHZ	RX/TX Freq: 144.050MHZ	A/B	

Digital to Analog Mode with same frequency:

Raido No.	End user	2# GD-88/as a Repeater	3# GD-88/as a Repeater	Band (Repeat)	Remarks
1#	RX Freq: 446.050MHZ Slot: 1; CC: 1	RX Freq: 446.050MHZ Slot: 1; CC: 1	RX Freq: 144.050MHZ Slot: 2; CC: 1	A/B	
	TX Freq: 446.050MHZ Slot: 2; CC: 1	TX Freq: 446.050MHZ Slot: 2; CC: 1	TX Freq: 144.050MHZ Slot: 1; CC: 1	A/B	
4#	Analog TX/RX Freq: 446.050MHZ	RX Freq: 144.050MHZ Slot: 1; CC: 1 TX Freq: 144.050MHZ Slot: 2; CC: 1	Analog TX/RX Freq: 446.050MHZ	A/B	Analog Mode can set with CTCSS/ DCS code

Notes:

- ◇ The above Repeat Modes examples are for reference only;
- ◇ If necessary, multi-mode, multi-band, multi-frequency and other ways can be combined and applied together to extend the communication coverage in end users. Such combination application of different Repeat modes can be used in scene field needed.

General guide for fault handling

Malfunction	Analysis of causes	Handling method
Radio fails to power on	Battery is installed incorrectly	Re-install battery
	Battery power lower than preset value	Please change or charge battery.
	Bad battery contacts or contacts in dirty.	Check and clear the battery contacts.
Receive signal decreases, is unclear or is interrupted.	Battery power gets lower.	Please change or charge battery.
	Volume control at low value.	Adjust the volume to be higher.
	Antenna gets loose or antenna frequency is incorrect.	Power off radio, and re-install antenna, or change antenna with right frequency.
	Speaker is blocked or damaged.	Try to clear the outer speaker or contact your dealer.
	Using the radio under poor working environment or electromagnetic interference	Change working environment or shift antenna direction.
Unable to communicate with group members	The current working channel frequency or signaling value is different.	Change channel or reset signaling and frequency to be same as the group members
	The setting of Digital or Analog channel is incorrect.	Reprogram the current digital or analog channel.
	Out of range of group members	Move back within range
Noise or unrelated communications on current channel	Co-channel user interference	Change frequency or channel.
	Channel not programmed with correct signaling	Reprogram radio to correct signaling or change signaling to prevent interference.
Weak voice traffic with noise during communications	The communication distance is too great	Reduce range between users.
	Signals are blocked during to environment such as buildings and terrain.	Reduce range between users or move to unimpeded line of sight.

Malfunction	Analysis of causes	Handling method
Weak voice traffic with noise during communications	Strong local environmental interference.	Move away from interference source.
Failure to obtain GPS position (Optional)	Radio lacks optional GPS feature or satellite view blocked by environment.	Add GPS feature; move to open site with clear view of sky.

 **Note:**

If the above methods fail to solve your problem, or you confront different malfunctions, please contact your local dealer or appointed maintenance station.

Maintenance and Clean

To ensure the best performance and prolong working life, please acquaint yourself with the following for maintenance and cleaning.

Maintenance

- Ⓞ Please do not scratch or puncture the device with hard or sharp object.
- Ⓞ Please do not place the device in an environment which can corrode electronic circuits or under direct solar radiation.
- Ⓞ Please do not carry the device by its antenna or headset.
- Ⓞ Please make sure the SP-MIC plug is covered when not in use.

Clean

- Ⓞ Please clean your device regularly by using a dry clean cloth or soft brush to wipe the dust on the surface and on the charger contacts;
- Ⓞ The keypads, control knob and housing of the device may be dirty from use. Please use nonwoven wipes to clean them. Do not use chemicals to clean it such as detergent, alcohol, spray or petroleum products, on the device surface or printed labels. Chemicals can damage the housing, display and remove the printing on the labels. Before power on the radio, please make sure the device is dry completely.

Radiod^dity