



## Mini Mobile Transceiver



# Radioddity QB25 Quad Band, Quad Standby External Speaker-PTT

Mini Size, PC Program, DTMF, 2 Tone, 5 Tone

136-174 / 220-270MHz  
350-390 / 400-480MHz



**USER'S MANUAL**



Radioddity' s first proprietary radio is designed to meet the most demanding of conditions, and dole out unmatched power while at the same time, being one of the safest, most comfortable radios on the market.

This manual is intended to help you find out how to operate the QB-25 more easily and to inform you the detailed specification and features. If you have any problems, please feel free to email support@***radioddity.com***. Customer means everything to us. Your concerns are our concerns.

# CONTENTS

ATTENTION!.....	3	DTMF Signalling.....	15
PRODUCT INSPECTION.....	4	Patrol Function.....	15
PANEL DESCRIPTION.....	5	Monitor Function.....	16
SAME TX RX FREQUENCY, DIFFERENT TX RX FREQUENCY CHANNEL MEMORY.....	11	Remote Stun.....	16
Same TX RX Frequency Channel Memory.....	11	Remote Kill.....	16
Different TX RX Frequency Channel (CTCSS/DCS) Memory (Connect Repeater).....	11	Remote Revive.....	16
MENU FUNCTION SETTING OPERATION.....	14	Emergency Alarm.....	17
Operation For Manual Channel Memory And Delete .....	14	DTMF Transmit By Call Key Setting.....	17
Memory FM Radio Channel.....	14	2 TONE And 2 TONE Signal Rransmit By Call Key Setting.....	17
Keypad Lock-out.....	14	5 TONE Signal Setting.....	18
Transmit Transit Signal.....	14	SPEAKER MICROPHONE DESCRIPTION....	19
PTT ID Setting.....	15	FUNCTION MENU.....	22
Optional Signalling Setup.....	15	GENERAL SPECIFICATIONS.....	32
DTMF Signalling Setup.....	15		

## ■ ATTENTION!

Please observe the following precautions to prevent fire, personal injury, damage to the radio:

- Don't use this machine when driving, so dangerous.
- This radio is designed to use 13.8 V dc voltage, do not use the 24 V power supply to the the mobile radio.
- Please do not place the machine in the dust, moisture or water splashing.
- If there's any electromagnetic interference, please keep the mobile radio away from the sources such as TV set, engine generator etc.
- Do not expose the mobile radio to long periods of direct sunlight, for example on the dashboard of a vehicle or close to heating appliances.
- If the mobile radio generate any smoke or strange smell, please turn off the power supply immediately and make sure all is safe, then you can send the unit to the nearest after-sale center for inspection or repairment.
- Do not keep transmitting with high power output for too long time, which may lead to overheating and cause auto power off or failure.

## ■ PRODUCT INSPECTION

Welcome to use our mobile radio, before operation, it is recommended that you:

- Please check the package is in good condition without any damage.
- Please unpack the package box carefully and check that all items are included.
- If you find any items are missing or have been damaged during shipment, please contact your dealer immediately.

### Standard accessories

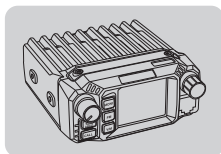

Mobile Radio



Speaker Microphone

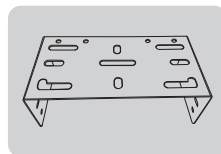

Mounting Bracket

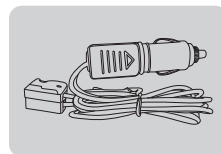

Cigar-plug Power Cable



Screws & Fuse

## ■ PANEL DESCRIPTION

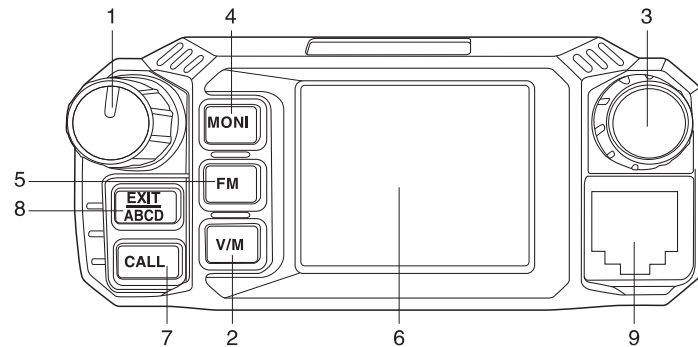

- |                                 |   |
|---------------------------------|---|
| 1 Power On/Off,<br>Volume Knob  | 5 FM Radio                                |
| 2 Mode Switch                   | 6 Display screen                          |
| 3 Progress Knob,<br>confirm key | 7 Call key                                |
| 4 Monitor                       | 8 A/B/C/D Band Switch,<br>Emergency Alarm |
|                                 | 9 Microphone Connector                    |

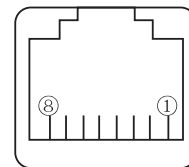

- |                 |
|-----------------|
| ① Data Input    |
| ② Null          |
| ③ MIC           |
| ④ MIC Ground    |
| ⑤ PTT.          |
| ⑥ GND           |
| ⑦ +8V DC Output |
| ⑧ Null          |

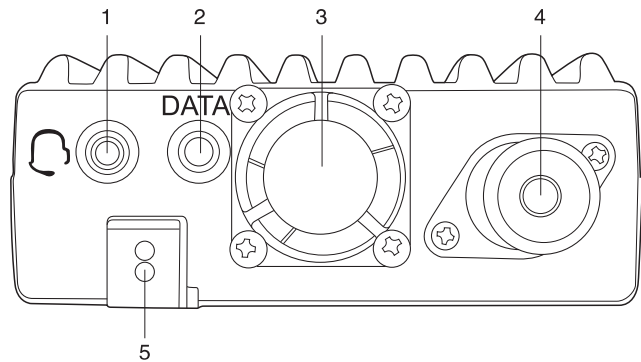

- 1 PTT/Microphone/GND
- 2 DATA
- 3 Fan
- 4 Antenna connector
- 5 DC power supply

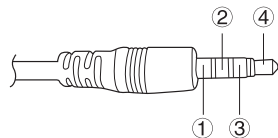

- ① GND
- ② SP
- ③ MIC
- ④ PTT

## Hotkey function guide

Power/Volume: Press the key to turn on the radio. Hold on the key for seconds to turn off the radio. Switch the knob to adjust the volume.

[ **CALL** ] : In standby mode, press to send caller ID at selected signaling mode, in transmit mode, press to send repeat activate signaling.

[ **MONI** ] : Press to turn on or turn off the squelch.

[ **V/M** ] : Press to select radio mode. Hold on for seconds to select power output at this mode.

[ **EXIT** ] : Press to exit function menu setting. In standby mode, press to select A, B, C, D frequency.

[ **FM** ] : Press to enter and exit FM radio function.

Coder/Function Key: Press to enter menu function setting mode. Hold on for seconds to exit function setting mode.

## Frequency Range Setting

Turn on the radio when show welcome words, hold on the Progress/Confirm Key, radio will shows PASSWORD. Enter the password to setting the frequency range and transmit frequency setting.

## Read and Write the Password Function

Choose a password, reading, and writing (set password, please remember, once set, after software to read and write all need password to work)

## LCD Description

Top place show spec at present working frequency/channel mode.

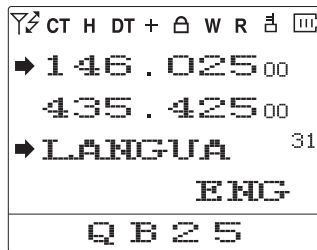

Addition transmit frequency under frequency mode.

Present channel have available DTMF signaling.

Present channel at High output power mode.

Present channel have set CTCSS.

Shows the radio if at correct working.

Present channel scrambler available.

Present channel work at wide band mode.

Shows present transmit and receive frequency reversal.

Shows keypad is locked.

Shows battery capability.

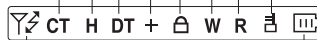

Present channel have set DCS.

Present channel at Low output power mode.

Present channel signaling is 2TONE signaling.

Present channel work at narrow band mode.

Reductive transmit frequency at frequency mode.

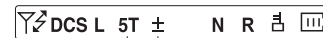

Present channel signaling is 5TONE signaling.

Show present channel transmit and receive at same frequency.

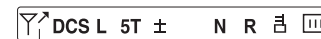

Radio only can transmit, can't work at receive.

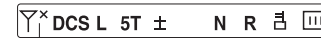

Radio transmit and receive both forbidden.

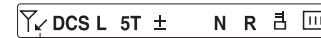

Radio only can receive, can't work at transmit.

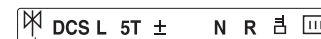

Shows at repeater mode.

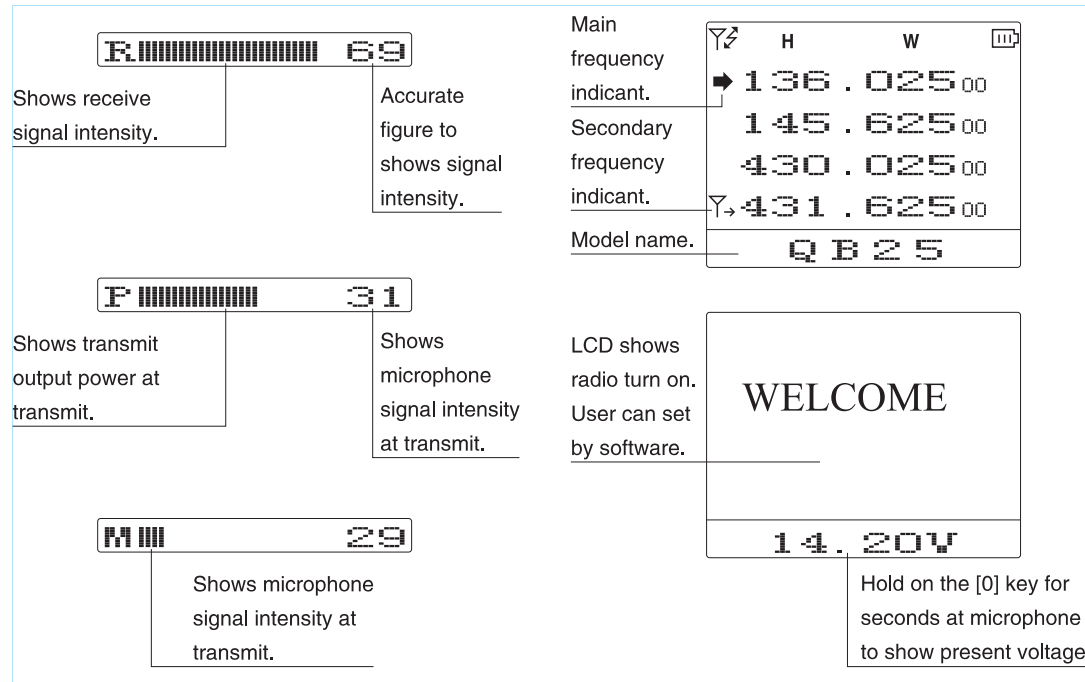

## ■ SAME TX RX FREQUENCY, DIFFERENT TX RX FREQUENCY CHANNEL MEMORY

### Same TX RX frequency channel memory

- ① Use keypad write require frequency, for example 146.6250, press microphone **[MENU]** key ( or Progress/confirm key)
- ② Menu select 44.
- ③ Press microphone **[MENU]** key ( or Progress/confirm key) to select channel 001. Press **[MENU]** key (or Progress/confirm key) again to memory it to CH-001.

If before setting already shows CH-001 (not 001) means channel 1 is memorized.

Delete this memorized channel: select menu 45, press **[MENU]** key (or Progress/confirm key), select channel CH-001 press **[MENU]** key (or Progress/confirm key) again to delete, LCD shows

001 is empty channel.

- ④ Press **[MENU]** key (or Progress/confirm key) to memory it, LCD shows CH-001.
- ⑤ Press **[MENU]** key (or Progress/confirm key) back to main menu, select 27, A- channel setting the frequency, channel number, channel name, press **[MENU]** key (or Progress/confirm key) to confirm.
- ⑥ Same use menu 28, 29, 30 to setting the B, C, D frequency.
- ⑦ Hold on the **[MENU]** key (or Progress/confirm key) for seconds to exit. Or **[EXIT/AB]** key.
- ⑧ At frequency mode, press **[MENU]** key enter or exit the channel.

### Different TX RX frequency channel (CTCSS/DCS) memory (connect repeater)

- ① Press **[MENU]** key (or Progress/confirm key), select menu 10.

② Press **[MENU]** key (or Progress/confirm key), setting the receive DCS figure.

③ Press **[MENU]** key (or Progress/confirm key) to confirm.

select menu 11 to setting the receive CTCSS

④ Press **[MENU]** key (or Progress/confirm key), setting the receive CTCSS figure.

⑤ Press **[MENU]** key (or Progress/confirm key) to confirm.

Select menu 12 setting transmit DCS.

⑥ Press **[MENU]** key (or Progress/confirm key), to setting the transmit DCS figure.

⑦ Press **[MENU]** key (or Progress/confirm key) to confirm.

⑧ Select menu 13. Press **[MENU]** key (or Progress/confirm key) to select transmit CTCSS figure.

⑨ Press **[MENU]** key (or Progress/confirm key) to confirm.

⑩ Press **[EXIT]** to exit.

If no need DCS/CTCSS then no then these steps.

Use microphone keypad press require frequency, for example 438.6250.

① Press microphone **[MENU]** key (or Progress/confirm key) enter menu.

② Menu select 44.

③ Press microphone **[MENU]** key (or Progress/confirm key) to select channel 002. Press **[MENU]** key (or Progress/confirm key) again to memory it to CH-002. If before setting already shows CH-002 (not 002) means channel 2 is memorized.

Delete this memorized channel: select menu 45, press **[MENU]** key (or Progress/confirm key), select channel CH-002 press **[MENU]** key(or Progress/confirm key) again to delete, LCD shows 002 is empty channel.

④ Press **[MENU]** key (or Progress/confirm key) to memory it, LCD shows CH-002.

⑤ Press **[EXIT/AB]** key to exit.

Microphone press frequency for example 430.6250.

⑥ Press microphone **[MENU]** key (or Progress/confirm key) select menu 44.

⑦ Press **[MENU]** key (or Progress/confirm key) select channel CH-002.

⑧ Press **[MENU]** key (or Progress/confirm key) memory this frequency to transmit channel. Back to main menu, select 27, A-channel setting the frequency, channel number, channel name, press **[MENU]** key (or Progress/confirm key) to confirm.

⑨ Same use menu 28, 29, 30 to setting the B, C, D frequency.

⑩ Hold on the **[MENU]** key (or Progress/confirm key) for seconds to exit. Or **[EXIT/AB]** key. At frequency mode, hold on **[MENU]** key for seconds to enter or exit channel.



## ■ MENU FUNCTION SETTING

### OPERATION

#### Operation For Manual Channel Memory And Delete

##### Channel memory:

1. Directly input frequency by keypad under frequency mode. Example: 435.125 MHz input 4,3,5,1,2,5.
2. Setting CTDCS frequency (manual page 10, 11). Setting transmit CTDCS frequency (manual page 12,13). For example: receive CTDCS 67.0HZ, transmit CTDCS 67.0HZ. Press **[MENU]** Key + **[1]** Key + **[1]** Key + **[MENU]** + **[UP]** Key. Select 67.0HZ + **[MENU]** Key.  
Transmit CTDCS 67.0HZ. Press **[MENU]** Key + **[1]** Key + **[3]** Key + **[MENU]** + **[UP]** Key. Select 67.0HZ + **[MENU]** Key. Press **[MENU]** Key again to save and exit. (If no need CTDCS all select OFF)
- 3 Select manual 44 to memory the channel, press **[MENU]** Key + **[4]** Key + **[4]** Key + **[MENU]** Key +

**[UP]** (DOWN) select channel + **[MENU]** Key to memory the channel information.

##### Delete channel:

Select menu 45. Press **[MENU]** + **[4]** + **[5]** + **[MENU]**+ **[UP]** (DOWN) select the channel number + **[MENU]** Key to delete.

##### Memory FM Radio Channel

Use PC software to edit FM radio channel. (Software FM option). Under transmit send DTMF code by microphone keypad. Press microphone **[\*]** Key to search FM channel under FM mode.

##### Keypad Lock-out

Hold the microphone **[#]** key for 2 seconds at standby to turn on/off the keypad lock-out function.

##### Transmit Transit Signal

Select transit signal frequency (out radio have 4 kind

transit signal frequency). Press **[MENU]** + **[5]** + **[0]** + **[MENU]** + **[UP]**(DOWN) select transit signal frequency + **[MENU]** key to save setting. Hold **[PTT]** and press **[CALL]** Key to transmit setting transit signal.

##### PTT ID Setting

Use PC software to edit PTT-ID code.

1. Manual 18, select signal. Press **[MENU]** + **[1]** + **[8]** + **[MENU]** + **[UP]**(DOWN) select signal + **[MENU]** save the setting.
2. Manual 20, setting PTT launch. Press **[MENU]** + **[2]** + **[0]** + **[MENU]** + **[UP]**(DOWN) select signal + **[MENU]** save the setting.
3. Manual 21, setting PTT transmit delay time. Press **[MENU]** + **[2]** + **[1]** + **[MENU]** + **[UP]** (DOWN) select delay time + **[MENU]** save the setting.
4. Press **[PTT]** to send setting ID code.

## Optional Signalling Setup

### DTMF Signalling Setup

This radio is capable of DTMF encode/decode feature, users can program the desired DTMF code by PC program.

### DTMF Signalling

If the radio is pre-programmed with DTMF signalling code, when it receive a matched code it will alert and display the corresponding code, also radios can communicate with each other in valid time. (ID code is programmable by PC software)

### Patrol Function

When receiving matched DTMF signalling which is same as pre-programmed patrol code, the radio will emit self ID code which will display on master control radio.

This function is able to select to be or not to be contr-

olled by master ID code, this function is not controlled by RX signalling. (Patrol code is programmable by PC software)

### Monitor Function

When receiving matched DTMF signalling which is same as pre-programmed monitor code, the radio will transmit to monitor the surrounding voice. This function is able to select to be or not to be controlled by master ID code, this function is not controlled by RX signalling. (Monitor code is programmable by PC software)

### Remote Stun

When receiving matched DTMF signalling which is same as pre-programmed remote stun code, transmitting is disabled, it will also alert on the display mode. The radio will restore to work normally only after remote revived. This function is able to select to be or not to be controlled by master ID code, this function is not controlled by RX signalling. (Remote stun code is

programmable by PC software)

### Remote Kill

When receiving matched DTMF signalling which is same as pre-programmed remote kill code, transmitting, receiving and all activities will be disabled, it will also alert on the display mode. The radio will restore to work normally only after remote revived. This function is able to select to be or not to be controlled by master ID code, this function is not controlled by RX signalling. (Remote kill code is programmable by PC software)

### Remote Revive

When receiving matched DTMF signalling which is same as pre-programmed remote revive code, the radio will be revived and restore to work normally. This function is able to select to be or not to be controlled by master ID code, this function is not controlled by RX signalling. (Remote revive code is programmable by PC software)

### Emergency Alarm

When receiving matched DTMF signalling which is same as pre-programmed emergency alarm code, the radio will emit emergency alarm. Emergency alarm mode and channel is PC programmable. This function is not controlled by master ID code and RX signalling. (Emergency alarm code is programmable by PC software)

Signalling controlled by master ID: Function will be implemented only when both signalling and mater ID matched.

Signalling no controlled by master ID format:signalling + # + Information Code

Signalling controlled by master ID format: signalling + # + Master ID code + # + Information Code

### DTMF Transmit By Call Key Setting

1. Select DTMF signal, press **[MENU]** + **[1]** + **[8]** + **[MENU]** + **[UP]** (DOWN) select DTMF signal + **[MENU]** save setting.
2. Select signal information code. Press **[MENU]** + **[2]** + **[2]** + **[MENU]** + **[UP]** (DOWN) select decode signal information code group (1–15) + **[MENU]** save the setting. (Can use PC software set DTMF code).
3. Press **[Call]** Key transmit selected DTMF code group at standby.

### 2 TONE And 2 TONE Signal Transmit by Call Key Setting

1. Press **[MENU]** select 18 OPTSIG, press **[MENU]** select 2 TONE function.
2. Press **[MENU]** select 22 S-INFO, press **[MENU]** select pre-code signal group (1–16). (Can use PC software setting 2 TONE).
3. Corresponding function will turn on when receive 2 TONE signal is same as pre-set 2 TONE code.

4. Press **[Call]** to send 2 TONE group code at standby.

### 5 TONE Signal Setting

This radio have 5 TONE coding/decode function. You can use PC software to input signal information code. (enter software signal edit select 5 TONE and setting). Receiver set 5 TONE signal, then after receive same 5 TONE signal (code must 5 bit) receiver turn on the ring function and display the information code. Speech at effective time is available. (ID code can use PC software to setting).

Press **[Call]** Key to transmit 5 TONE.

1. Press **[MENU]** key, select 18 OPTSIG press **[MENU]** select 5 TONE function, press **[MENU]** to confirm setting.
2. Press **[MENU]** , select 22 S-INFO press **[MENU]** key to select pre-code signal group 1-15. (Can use PC software setting 5 TONE information code, each group can transmit 3 group 5 TONE code for optional).

3. Press **[Call]** key transmit pre-set 5 TONE code group at standby.

### ■ SPEAKER MICROPHONE DESCRIPTION (optional)

- ① "MENU": Function key
- ② "UP": Tune up channel step
- ③ "DOWN": Tune down channel step
- ④ "EXIT": Exit A/B channel switch, emergency alarm etc.
- ⑤ "\*/SCAN": Offset function, scan, digital "\*"
- ⑥ "#/LOCK": Keypad lockout function, digital "#"
- ⑦ "0": Number 0
- ⑧ "1": Number 1
- ⑨ "2": Number2
- ⑩ "3": Number3
- ⑪ "4": Number4
- ⑫ "5": Number5
- ⑬ "6": Number6
- ⑭ "7": Number7
- ⑮ "8": Number8
- ⑯ "9": Number9

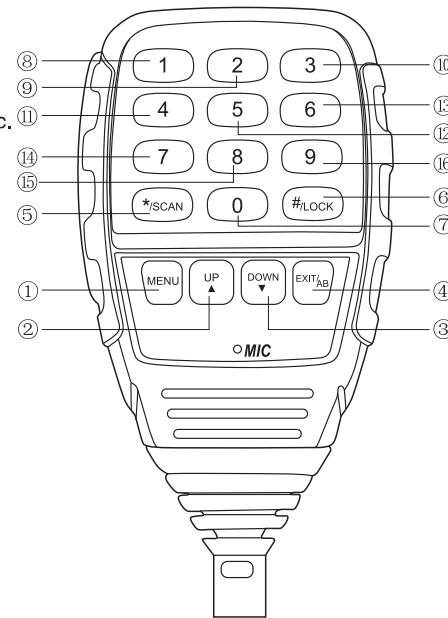

## SPEAKER MICROPHONE DESCRIPTION (optional)

- ① "MENU": Function key
- ② "UP": Tune up channel step
- ③ "DOWN": Tune down channel step
- ④ "EXIT": Exit A/B channel switch, emergency alarm etc.
- ⑤ "\*/SCAN": Offset function, scan, digital "\*\*"
- ⑥ "#/LOCK": Keypad lockout function, digital "#"
- ⑦ "0": Number 0
- ⑧ "1": Number 1
- ⑨ "2": Number 2
- ⑩ "3": Number 3
- ⑪ "4": Number 4
- ⑫ "5": Number 5
- ⑬ "6": Number 6
- ⑭ "7": Number 7
- ⑮ "8": Number 8
- ⑯ "9": Number 9

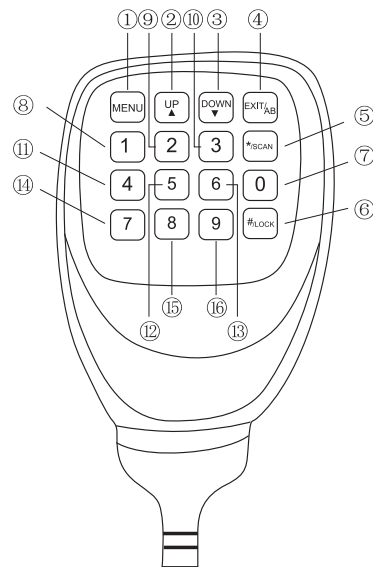

## Microphone Keypad Operation

1. Hold on microphone **[MENU]** key for seconds can switch select channel mode or frequency mode.
2. Press **[#]** key to switch High/Low transmit output power.
3. Hold on **[#]** key for seconds to Lock/Unlock the keypad.
4. Hold on **[EXIT/AB]** key for seconds to active Alarm mode.
5. Press **[EXIT/AB]** key select present working frequency.
6. Press **[\*]** key to reverse the transmit frequency and receive frequency.
7. Hold on **[\*]** key to start Scan function.
8. Hold on **[0]** key for seconds, to display present power supply voltage

## FUNCTION MENU

Menu	Primary Menu Icon	Secondary Menu Icon	Secondary Function Description
0	TMR	OFF	Disable TMR (multiple standby function)
		M+A	Enable TMR, main frequency and A frequency standby
		M+B	Enable TMR, main frequency and B frequency standby
		M+C	Enable TMR, main frequency and C frequency standby
		M+D	Enable TMR, main frequency and D frequency standby
		M+A+B	Enable TMR, main frequency A and B frequency standby
		M+A+C	Enable TMR, main frequency A and C frequency standby
		M+A+D	Enable TMR, main frequency A and D frequency standby
		M+B+C	Enable TMR, main frequency B and C frequency standby
		M+B+D	Enable TMR, main frequency B and D frequency standby
		M+C+D	Enable TMR, main frequency C and D frequency standby
		M+A+B+C	Enable TMR, main frequency A B and C frequency standby
		M+A+C+D	Enable TMR, main frequency A C and D frequency standby
		M+B+C+D	Enable TMR, main frequency B C and D frequency standby
A+B+C+D	Enable TMR, A B C and D frequency standby		
1	STEP	2.50K	In frequency mode, press [UP] and [DOWN] to select step figure.
		5.00K	
		6.25K	
		10.00K	
		12.50K	
		25.00K	

2	SQL	0, ..., 9	Squelch level 0–9 selective
3	TXP	HIGH	High power output
		LOW	Low power output
4	SCR	OFF	Disable Scrambler function
		ON	Enable Scrambler function
5	TOT	15,30, ..., 600	Time out timer, 15–600s selective, step is 15s.
6	APO	OFF, 30, 60, 90 ... 300	Auto power off time (no signal, no operation)
7	WN	WIDE	Wide band
		NARR	Narrow band
8	ABR	OFF	backlight always on
		1, 2, 3, 4, 5	Auto backlight off time (Color screen unavailable)
9	BEEP	OFF	Alert tone off
		ON	Alert tone on
10	R–DCS	OFF	None DCS tone programmed
		D023N, ..., D754I	Desired DCS tone programmed
11	R–CTCS	OFF	None CTCSS tone programmed
		67.0HZ, ..., 254.1HZ	Desired CTCSS tone programmed, and can directly input by keypad.
12	T–DCS	OFF	None DCS tone programmed
		D023N, ..., D754I	Desired DCS tone programmed
13	T–CTCS	OFF	None CTCSS tone programmed
		67.0HZ, ..., 254.1HZ	Desired CTCSS tone programmed, and can directly input by keypad.
14	DTMFST	OFF	Radio will not emit code tone when transmitting DTMF code

		KEY	Radio emit code tone when manually transmitting DTMF code by key
		ID	Radio emit code tone when auto transmitting the DTMF code
		BOTH	Radio emit code tone in both conditions
15	BCL	OFF	Radio can transmit at any time
		ON	Radio cannot transmit when the selected channel is busy
16	SC-ADD	OFF	Deletes the Channel from the SCAN list
		ON	Adds the Channel to the SCAN list
17	SC-REV	TO	Scan by time
		CO	Scan by carrier
		SE	Scan by search
18	OPTSIG	OFF	Disable optional signalling
		DTMF	DTMF as optional signalling
		2TONE	2 TONE as optional signalling
		5TONE	5 TONE as optional signalling
19	SPMUTE	QT	Speaker unmutes when receiveing matched QT/DQT
		AND	Speaker unmutes when receiveing both matched optional signalling and QT/DQT
		OR	Speaker unmutes when receiveing either matched optional signalling or QT/DQT
20	PTT-ID	OFF	Disable PTT-ID transmit
		BOT	Press PTT to transmit signalling code (set by software)
		EOT	Release PTT to transmit signalling code
		BOTH	Press PTT and Release PTT to transmit signalling code

21	PTT-LT	0, 1, ..., 30	Delay time before PTT-ID transmit
22	S-INFO	1, ..., 15	Signalling code can be programmed by PC software only
23	EMC-TP	ALARM	Radio emit emergency alarm tone
		ANI	Radio emit emergency alarm code and ANI code
		BOTH	Radio emit emergency alarm tone, alarm code and ANI code
24	EMC-CH	000, ..., 199	Radio will emit emergency alarm from specified emergency alarm channel
25	SIG-BP	OFF	Signalling available not prompt
		ON	Signalling available prompt
26	CHNAME		In channel mode to edit the channel name
27	CA-MDF	FREQ	Frequency mode
		CH	Channel display mode
		NAME	Channel name display mode (name set by software)
28	CB-MDF	FREQ	Frequency mode
		CH	Channel display mode
29	CC-MDF	NAME	Channel name display mode (name set by software)
		FREQ	Frequency mode
30	CD-MDF	CH	Channel display mode
		NAME	Channel name display mode (name set by software)
		FREQ	Frequency mode

31	LANGUA	ENG	English menu
		CHS	Chinese menu
32	AUTOLK	OFF	Disable keypad auto lockout function
		ON	Enable keypad auto lockout function
33	MAINFC	BLACK	Setting main LCD figure color
		WHITE	
		RED	
		BLUE	
		GREEN	
		YELLOW	
		INDIGO	
		PURPLE	
34	MAINBC	BLACK	Setting main LCD back color
		WHITE	
		RED	
		BLUE	
		GREEN	
		YELLOW	
		INDIGO	
		PURPLE	
35	MENUFC	BLACK	Setting Menu figure color
		WHITE	
		RED	

		BLUE				
		GREEN				
		YELLOW				
		INDIGO				
		PURPLE				
		GRAY				
		36		MENUBC	BLACK	Setting Menu back color
					WHITE	
RED						
BLUE						
GREEN						
YELLOW						
INDIGO						
PURPLE						
37	STA-FC	GRAY	Setting top figure front color			
		BLACK				
		WHITE				
		RED				
		BLUE				
		GREEN				
		YELLOW				
		INDIGO				
PURPLE						
		GRAY				

38	STA-BC	BLACK	Setting top figure back color
		WHITE	
		RED	
		BLUE	
		GREEN	
		YELLOW	
		INDIGO	
		PURPLE	
		GRAY	
39	SIG-FC	BLACK	Setting bottom signal figure color
		WHITE	
		RED	
		BLUE	
		GREEN	
		YELLOW	
		INDIGO	
		PURPLE	
		GRAY	
40	SIG-BC	BLACK	Setting bottom signal figure back color
		WHITE	
		RED	
		BLUE	
		GREEN	
		INDIGO	

41	RX-FC	PURPLE	Set receiving figure color
		GRAY	
		BLACK	
		WHITE	
		RED	
		BLUE	
		GREEN	
		YELLOW	
		INDIGO	
42	TX-FC	PURPLE	Set transmitting figure color
		GRAY	
		BLACK	
		WHITE	
		RED	
		BLUE	
		GREEN	
YELLOW			
43	TXDISP	POWER	Bottom signal shows output power at transmit
		MIC-V	Bottom signal shows volume at transmit
44	MEM-CH	000, ..., 199	Select a channel (000-199) to store desired frequency, the channel (000-199) with "CH" was already programmed with frequency
45	DEL-CH	000, ..., 199	Delete the channel information, if the channel number without "CH" means no programmed



46	SFT-D	OFF	Offset is turn off, TX RX frequency is same
		+	Plus offset, means TX frequency is higher then RX
		-	Minus offset, means TX frequency is lower then RX
47	OFFSET		Offset frequency range is 00.000-69.990MHz selective. In VFO mode, the offset between TX and RX
48	ANI		ANI code, programmed by PC software only
49	ANI-L	3, 4, 5	Length of ANI code
50	REP-S	1000	Transmitting press CALL to send 1000Hz to activate repeater function
		1450	Transmitting press CALL to send 1450Hz to activate repeater function
		1750	Transmitting press CALL to send 1750Hz to activate repeater function
		2100	Transmitting press CALL to send 2100Hz to activate repeater function
51	REP-M	OFF	Disable repeater transponder function
		CARRI	Repeater transpond when receiving matched carrier
		CTDCS	Repeater transpond when receiving matched CTCSS/DCS
		TONE	Repeater transpond when receiving matched tone
		DTMF	Repeater transpond when receiving matched DTMF code
52	TMR-MR	OFF, 1, 2, 3, ... 50	Delay time for main frequency back, at multi standby
53	STE	OFF	Disable squelch tail-eliminated function
		ON	Enable squelch tail-eliminated function

54	RP-STE	OFF, 1, 2, 3, ...10	1-10 indicate squelch tail length, used to eliminate squelch tail noise produced
55	RPT-DL	OFF, 1, 2, 3, ...10	1-10 select delay time to receive repeater tail noise
56	DTMF-G	0, 1, 2, 3, ... 60	Set DTMF gain
57	RESET	VFO	Reset the menu mode to factory default setting
		ALL	Reset all memories and other setting to factory default setting

## ■ GENERAL SPECIFICATIONS

### General Specifications

Frequency range	VHF: 136~174MHz 220~270MHz UHF: 350~390MHz 400~480MHz
Channel capacity	200 channels
Channel Spacing	25KHz / 20KHz / 12.5KHz
Channel step	2.5KHz / 5KHz / 6.25KHz / 10KHz / 12.5KHz / 25KHz
Working Voltage	13.8V DC $\pm$ 15%
Squelch way	CARRIER / CTCSS / DCS / 5Tone / 2Tone / DTMF
Frequency stability	$\pm$ 2.5ppm
Operating temperature	-20~+60°C
Dimension	98 ( W ) x 44 ( H ) x128 ( D ) mm
Weight	448g

### Receiver (ETSI EN 300 086 Standardized.Test)

	Wide Band	Narrow Band
Sensitivity	$\leq$ 0.25 $\mu$ V	$\leq$ 0.35 $\mu$ V
Adjacent Channel Selectivity	$\geq$ 70dB	$\geq$ 60dB
Intermodulation	$\geq$ 65dB	$\geq$ 60dB
Spurious Rejection	$\geq$ 70dB	$\geq$ 70dB
Audio response	+1~-3dB (0.3~3KHz)	+1~-3dB (0.3~2.55KHz)
Hum & Noise	$\geq$ 45dB	$\geq$ 40dB
Audio Distortion	$\leq$ 5%	
Audio output power	$\geq$ 2W@10%	

### Transmit (ETSI EN 300 086 Standardized.Test)

	Wide Band	Narrow Band
Output power	25W/20W(VHF/UHF)	
Modulation Mode	16K $\Phi$ F3E	11K $\Phi$ F3E
Adjacent Channel Selectivity	$\geq$ 70dB	$\geq$ 60B
Hum & Noise	$\geq$ 40dB	$\geq$ 36dB
Spurious Emission	$\geq$ 60dB	$\geq$ 60dB
Audio response	+1~-3dB (0.3~3KHz)	+1~-3dB (0.3~2.55KHz)
Audio distortion	$\leq$ 5%	

Attention: Above specifications are subject to change without any notice due to technology enhancement.